

# CHEVS OF THE 40'S

*World's most complete supplier of 1937-54 Chevrolet car & truck parts*

## **2022 EDITION TRUCK CATALOG**

Order:

1-800-999-CHEV (2438)

1-360-816-0211

Fax: 1-800-888-CHEV (2438)

\$4.50



1-800-999-CHEV(2438)

Shop online: [www.chevsofthe40s.com](http://www.chevsofthe40s.com)

*To our Valued Customers:*

For over 4 decades we have been providing the best in restoration parts for 1937–54 Chevrolet Cars & Trucks. We continue to expand our inventory of hard-to-find restoration parts while improving our selection of Street Rod Parts. We strive to provide the best in service, quality and variety of parts needed for your vehicle—from a complete restoration to a full-blown street machine. We have an easy to use Illustrated Index in the front of our catalog to make finding parts easy along with an alphabetical Parts Index in the back.

Street Rod parts are found in our STREET ROD HEADQUARTERS catalog and online at [www.STREETRODHQ.com](http://www.STREETRODHQ.com).

*Thanks for your business!*

*Ron Wade  
Owner*

## HOW TO ORDER

**ONLINE:** Order anytime by accessing our online catalog from our website, [www.chevsofthe40s.com](http://www.chevsofthe40s.com). Credit card information is secure and we don't sell our customer database to anyone.

**Call toll-free:** 1-800-999-CHEV (2438)

Our sales reps are available to assist you:

- via the phone: 6 a.m. – 5 p.m. Pacific Time, Mon. – Fri.
- in the showroom: 8 a.m. – 5 p.m., Mon. – Fri.
- via our lovable voice mail for after-hour and weekend calls.

Existing customers—Simply provide your name and customer number off your catalog label, vehicle year, series and body style, credit card number (if appropriate), part numbers with descriptions and quantities.

New customers—Please provide all of the above information as well as your phone number (in case we have a question about the order) and a complete address including zip code.

---

**Stuff our attorneys want us to say: Chev's of the 40's will not be responsible for any expenses incurred for installation, modification, fitting or shop repairs of parts. The items sold in this catalog are without warranties of any kind. Items and prices in this catalog are subject to change without notice. Information in this catalog may contain typographical errors or inaccuracies. We reserve the right to correct errors or omissions.**

## HOW TO PAY

Use **Check by Phone** to achieve prompt shipping (10 days faster than mailing a check.) And because it helps reduce our costs, our reward to you is a 4% discount on parts when you place your first electronic-check order by phone. Try it—it's convenient and secure.

**Checks** by mail are welcome; however the accounting department may hold your order on uncertified funds. At company discretion, a mailed-in check may be converted to an electronic check.

Checks and money orders need to be in U.S. funds.

*Returned checks will be charged an NSF fee.*

**Credit Cards**—Visa, MasterCard and Discover are welcome! Ship-to address must match your credit card billing address.

## HOW WE SHIP

**How We Ship:** We ship via UPS and USPS Flate Rate Priority Mail (size and weight permitting). For international orders we use UPS Expedited or USPS Priority Mail. Please talk to our sales staff for a shipping quote.

When purchasing oversized parts, some can be shipped via UPS and others need to be sent via truck freight, so please call for rates.

If paying by check, please call for shipping rates and order total.

**Shipping Time** on ground deliveries takes 2 to 14 days depending on your location. For faster service options, when placing an order, please ask your sales person for an express delivery quote.

*Most orders ship the same day!*

**Sales Tax:** Due to the Wayfair decision, we must now charge sales tax to all applicable states. Tax is calculated on the order total (including shipping). Tax rates vary according to your region.

## HOW PROBLEMS ARE HANDLED

**Damage Claims:** If a package appears to be damaged upon delivery, open the package with the delivery driver and have them note any damages. Then call Chev's of the 40s immediately to notify us of any problems/damages. Do not ship to Chev's of the 40s; we will let you know what to do next.

**Shortages:** All orders are scanned with a bar code reader before shipping. If, in the unlikely event a shipment error occurs, call us immediately.

**Back Orders:** Our computerized inventory system allows us to maintain tight control on our stocking levels. However, we do not have control over our suppliers. Back orders are not charged until they ship. Shipment occurs immediately when we receive the part.

## RETURNS/EXCHANGES

Made-to-order items, such as glass, are non-returnable. All other parts (excluding Odds & Ends) may be returned within 30 days. Damaged or altered parts cannot be returned. CODs will not be accepted. Returns subject to a 25% restocking fee.

1. Have your invoice ready.
2. Call 1-800-999-CHEV (2438).
3. Obtain return authorization number.
4. Write the number on the outside of the package and on a copy of the invoice.
5. Include invoice copy in package.

Remember: Shipping can take up to 14 days, so allow 3–4 weeks on returns. Warranty applies only to purchase price of item or replacement of part.

Unfortunately credit card companies no longer credit your credit cards for returns after 90 days. Therefore, we will issue in-store credits or a refund check.

*Note: Product pricing and availability subject to change.*

## PHOTOS

Email us high-resolution photos of your restored and street rod Chevys! We love to see them and might even put them in one of our catalogs or advertisements!



**You can now have your car or truck on the cover of your catalog!**

It's easy!! Simply visit [www.chevsofthe40s.com](http://www.chevsofthe40s.com) and click the link for "get your own vehicle on your own cover." After you upload a photo, the next time we print catalogs, your catalog will feature your car or truck framed on the cover!



**SRHQ STREET ROD HEADQUARTERS**

**800-952-1752**  
**[www.streetrodhq.com](http://www.streetrodhq.com)**

**Need the latest and greatest parts for your street rod? Ask for our latest Street Rod Headquarters parts catalog. Call us at 800-952-1752 or visit us on the web at [www.streetrodhq.com](http://www.streetrodhq.com).**

**CHEVS OF THE 40'S**  
*World's most complete supplier of 1937-54 Chevrolet car & truck parts*  
**CAR CATALOG**

Order:  
1-800-999-CHEV (2438)  
1-360-816-0211  
Fax: 1-800-888-CHEV (2438)  
\$4.50 



1-800-999-CHEV(2438)  
Shop online: [www.chevsofthe40s.com](http://www.chevsofthe40s.com)

**Call for your copy of our newest Car Catalog!**

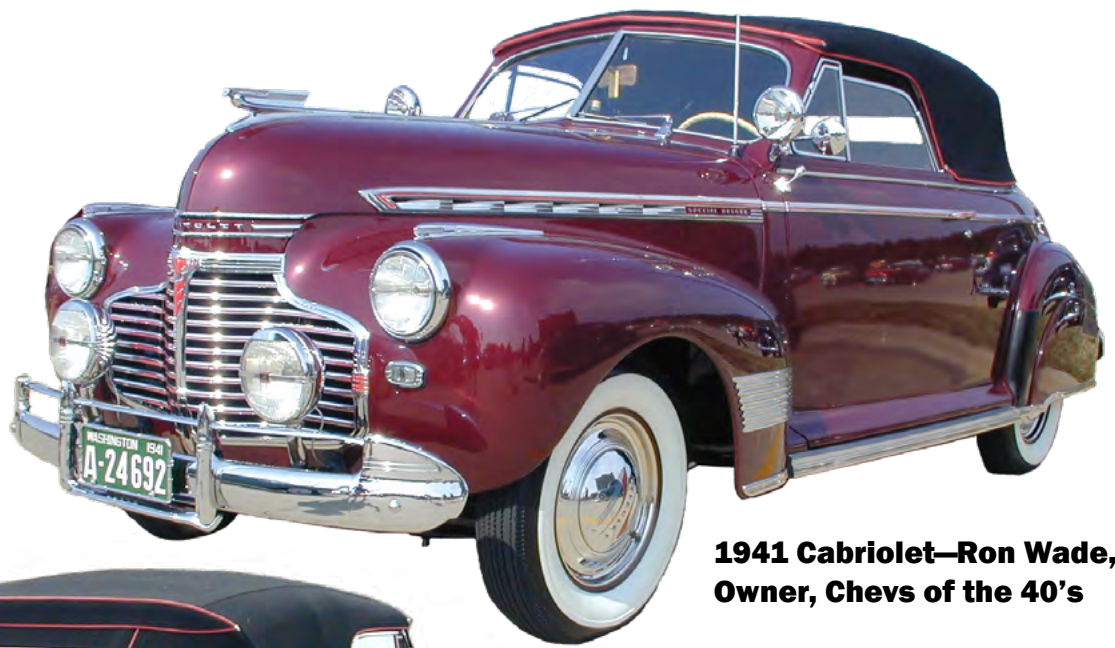

**1941 Cabriolet—Ron Wade, Owner, Chevs of the 40's**



**Ron Wade's National Vintage Chevrolet Club of America's Best of Show 1941 Cabriolet has over 50 accessories:**

Air filter-oil bath, antenna-reel, armrest-center, back-up light, beauty rings, clock-electric, compass, cowl vent knob-ivory, crank support-front bumper, crank-hand, defroster, driving lights, emergency brake whistle, exhaust tip-sharks tail, fender skirts, flashlight, fold-down rear guard, foot scraper, gas cap-GM locking, GM caroma, grill-winter guard, grill guard-bumper, heater-super deluxe, hood ornament-flying lady, horn-town & country, initial holder, license frames, mirror-day/night, mirror-lighted vanity, mirror-right, oil filter, passing lights, radiator screen-outside, radiator-overflow tank, radio-AM and 4-band short wave, radio-pocket portable, rear axle 3.70, rear fender guards, spare tire inflator, spotlight-left and right, steering wheel-spinner, thermometer, tire pump, tires-whitewall, tool kit, turn signals, umbrella-silk, valve cover breather, visor-clip-on, washboards-front fender, wheel disks, and windshield washers.



*"After looking for over 40 years and talking to hundreds of people, nobody had ever seen the license plate reflectors. I was as excited as a little kid when I found them at the 2014 Hershey Swap Meet."—Ron Wade*

## Core charge information

All core charges are refundable when we receive your rebuildable unit in exchange. Please remove all external parts and brackets. Core returns must be same as purchased unit.

## Part number information

Group and part numbers are original GM when applicable so you may refer to Chev parts book for questions.

## Exceptions

Suffix "A"—part not originally available by itself.

Suffix "B"—not originally available as an assembly. Other suffixes, not originally available by itself or is a modified part.

If you have an addition or correction for this catalog, please give us a call. We want to provide the best possible service for you!

## \*CHEMICALS

**Chemicals are shipped domestic ground only (lower 48 states only.) No international shipping.**

## Illustration Index

Air Conditioning & Heating . . . . .	35T
Axle—Front & Rear . . . . .	200T
Brake Parts . . . . .	180T
Bumper . . . . .	230T
Camshaft . . . . .	20T
Chassis . . . . .	pg. 6
Clutch, Drive Shaft and Rear End . . . . .	140T
Complete Bed . . . . .	pg. 7
Complete Truck Bed Order Form . . . . .	490T
Crankshaft . . . . .	20T
Custom Wheels . . . . .	220T
Dash Knobs . . . . .	340T
Door Assembly . . . . .	380T
Door Panels . . . . .	330T
Driving, Fog and Spot Lights . . . . .	85T
Electrical System . . . . .	pg. 5
Engine Assembly . . . . .	20T
Engine ID Chart . . . . .	20T
Engine Kits . . . . .	20T
Exhaust System . . . . .	130T
Exterior . . . . .	pg. 6
Front & Rear Suspension Kits . . . . .	205T
Gauges—Classic Instruments . . . . .	350T
Glass . . . . .	pg. 5
Headlamp . . . . .	85T
Heating & Air Conditioning . . . . .	35T
Horn Contact Parts . . . . .	190T
IFS/IRS Suspension Kits . . . . .	205T
Interior Kits . . . . .	330T
Interior . . . . .	pg. 4
Knobs . . . . .	340T
Paint Combination Chart . . . . .	pg. 11
Rubber . . . . .	pg. 5
Series ID Table . . . . .	pp. 8–10
Sheet Metal . . . . .	pg. 7
Starter/Generator & Related . . . . .	40T
Steering Gear . . . . .	190T
Suspension (aftermarket) . . . . .	205T
Suspension (stock) . . . . .	200T
Taillamp . . . . .	85T
Transmissions . . . . .	150T
Truck Body Parts (Sheet Metal) . . . . .	295T
Window Channel . . . . .	450T
Windshield Wipers . . . . .	370T
Wiring Harness . . . . .	60T

## Number ID, Production Numbers, Paint & Trim Charts (Sect. 5T, 8T)

Art, Collectibles, Tools, Auto Care, Truck Covers (Sect. 10T, 12T, 15T)

Engine (Sect. 20T, 22T, 24T, 26T)

Cooling, Heating (Sect. 30T, 35T)

Engine Electrical: Starters, Alternators, Distributors, Ignition (Sect. 40T, 45T, 50T, 55T)

Electrical, Horn (Sect. 60T)

Lighting: Turn Signals, Headlights, Tail Lights (Sect. 80T, 85T, 90T, 100T, 110T)

Fuel & Exhaust (Sect. 120T, 130T)

Clutch, Transmission, Driveline, Drive Shaft, Rear Axle, Rear End (Sect. 140T, 150T, 160T, 170T)

Brakes, Steering (Sect. 180T, 190T)

Suspension, Wheels, Hubcaps, Bearings (Sect. 200T, 205T, 210T, 220T)

Bumpers, Grilles, Hoods (Sect. 230T, 240T, 250T)

Fenders, Running Boards, Step Plates (Sect. 270T, 290T)

Body: Sheet Metal, Cab, Cab Mounting (Sect. 295T, 300T)

Firewall, Floorboard, Interior (Sect. 310T, 320T, 330T)

Dash, Mirrors, Radio, Wipers (Sect. 340T, 345T, 350T, 360T, 370T)

Doors (Sect. 380T, 390T, 400T)

Windows: Glass and Rubber (Sect. 420T, 430T, 440T, 450T, 460T, 480T)

Complete Beds & Parts (Sect. 490T)

Manuals, Tags, Decals, Photos (Sect. 520T, 530T, 550T, 560T)

## Parts Index

# Picture Table of Contents — Interior

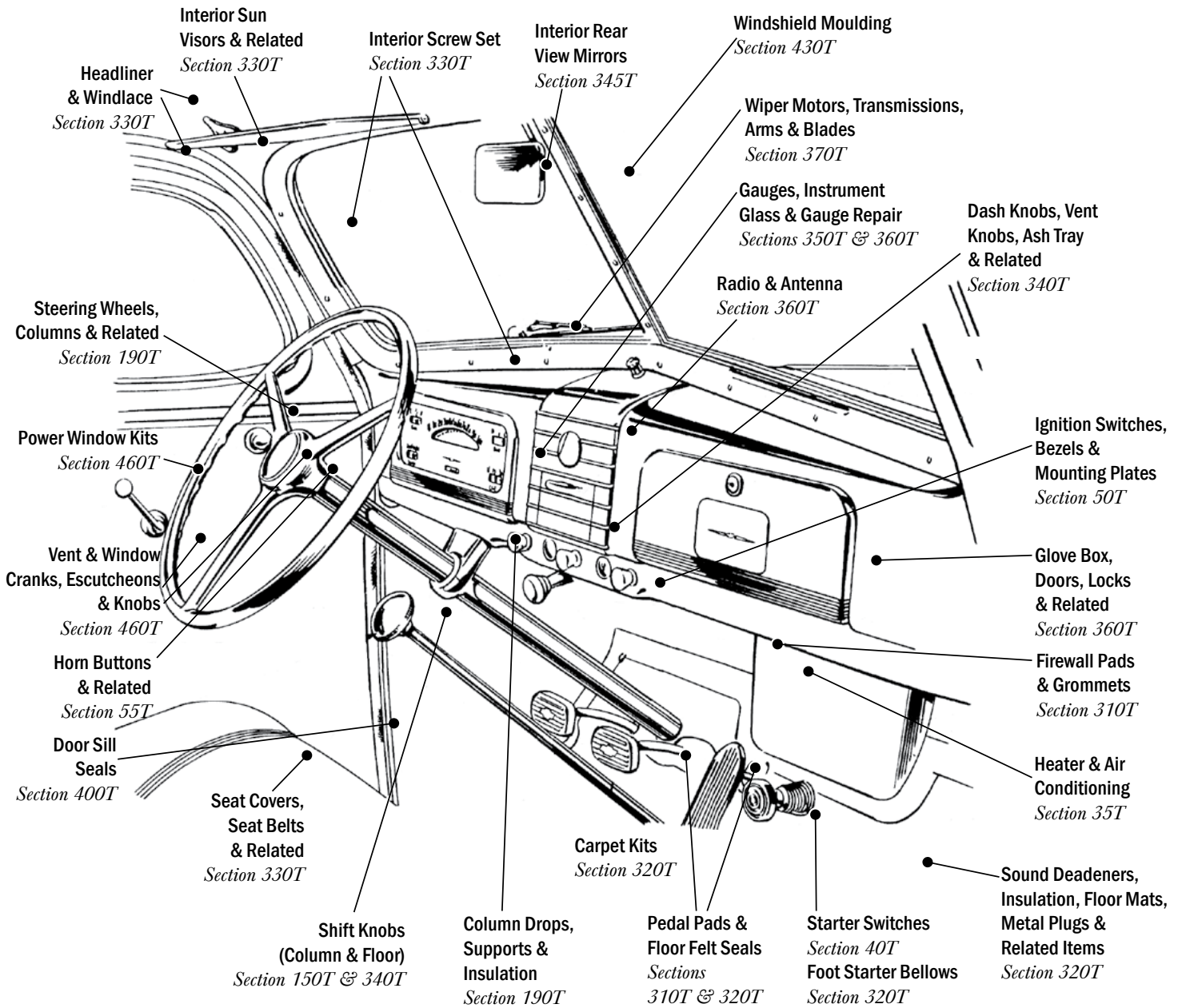

Returns require a return authorization number—Please call first. • Note: Product pricing and availability subject to change.

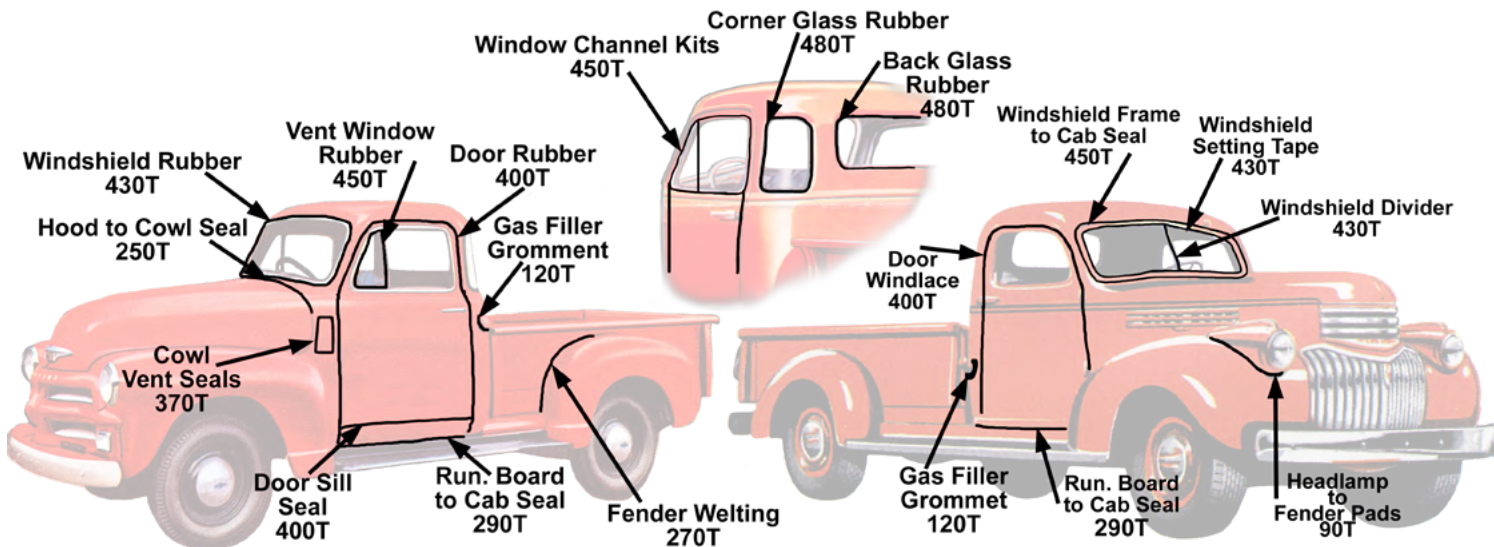
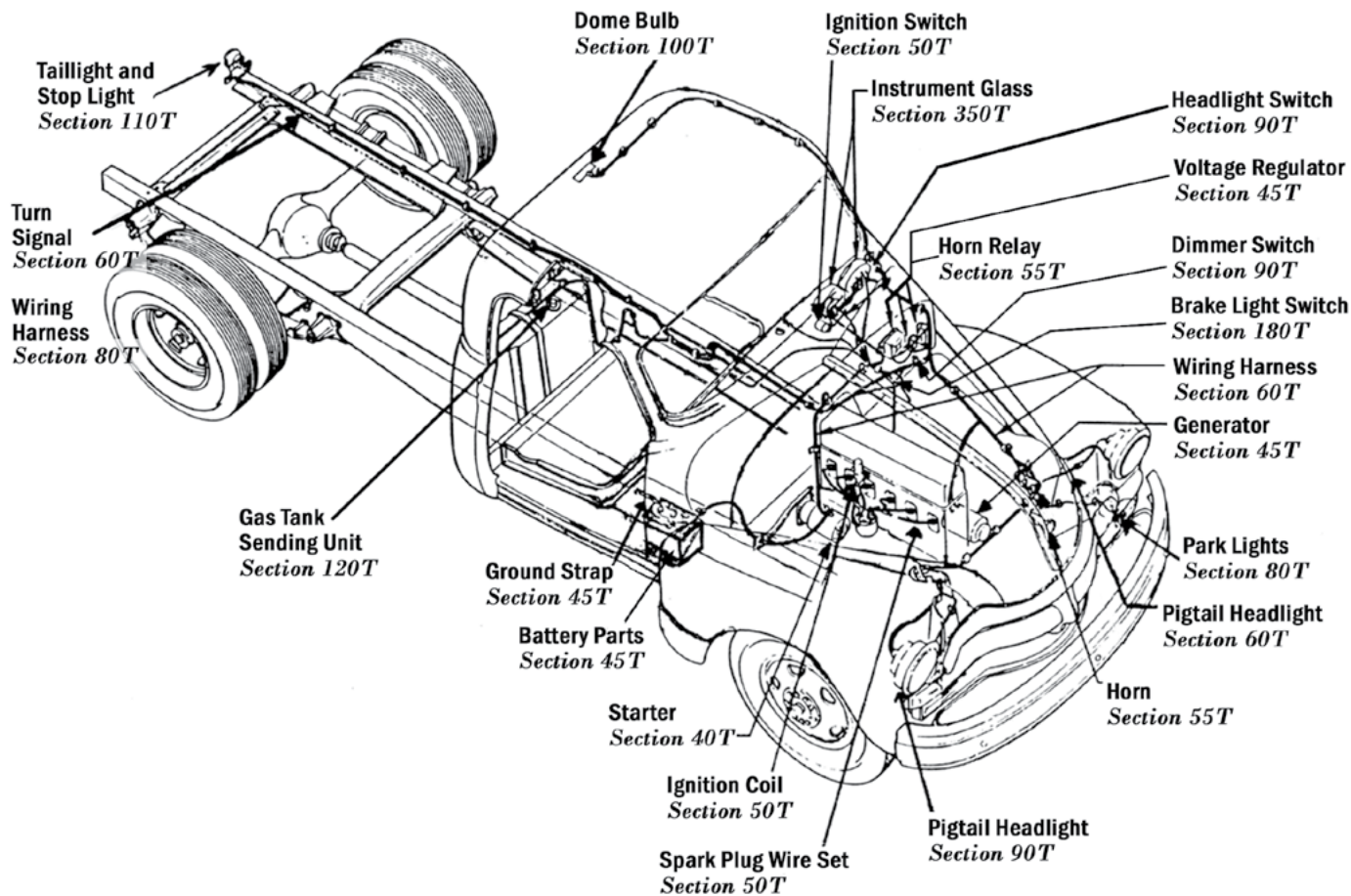

NOTE: Any chemicals will be shipped domestic ground only (Lower 48 states only). No international shipping.

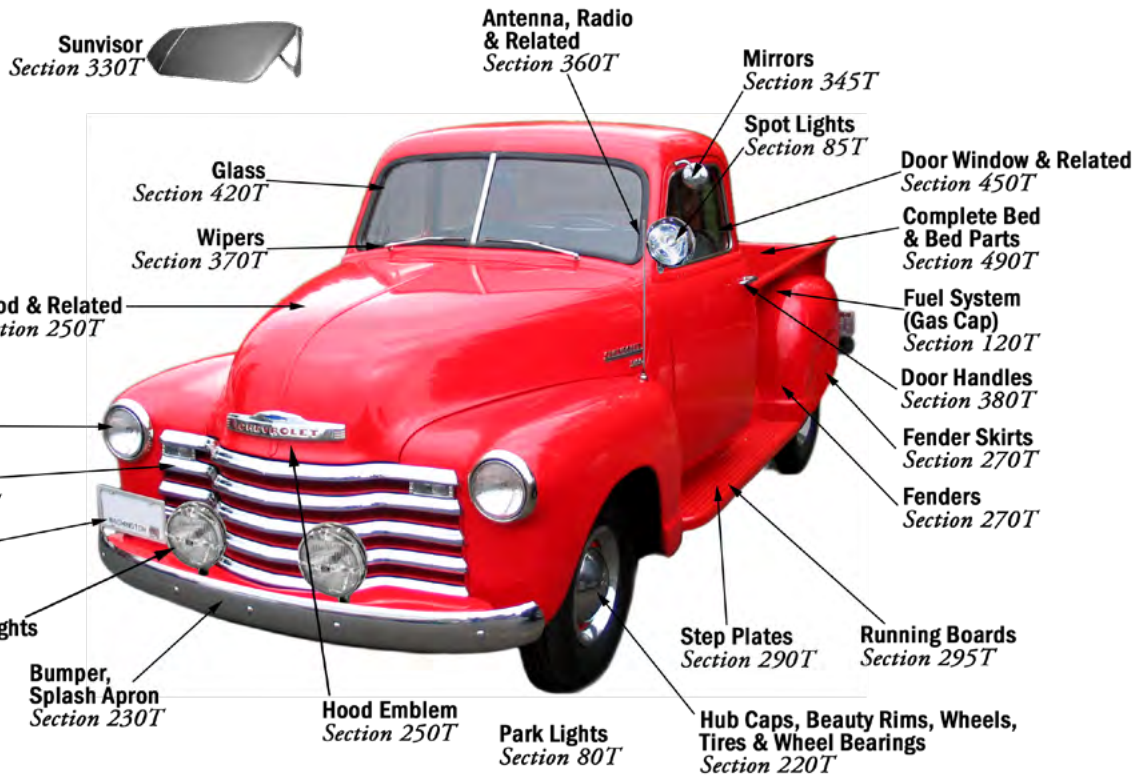
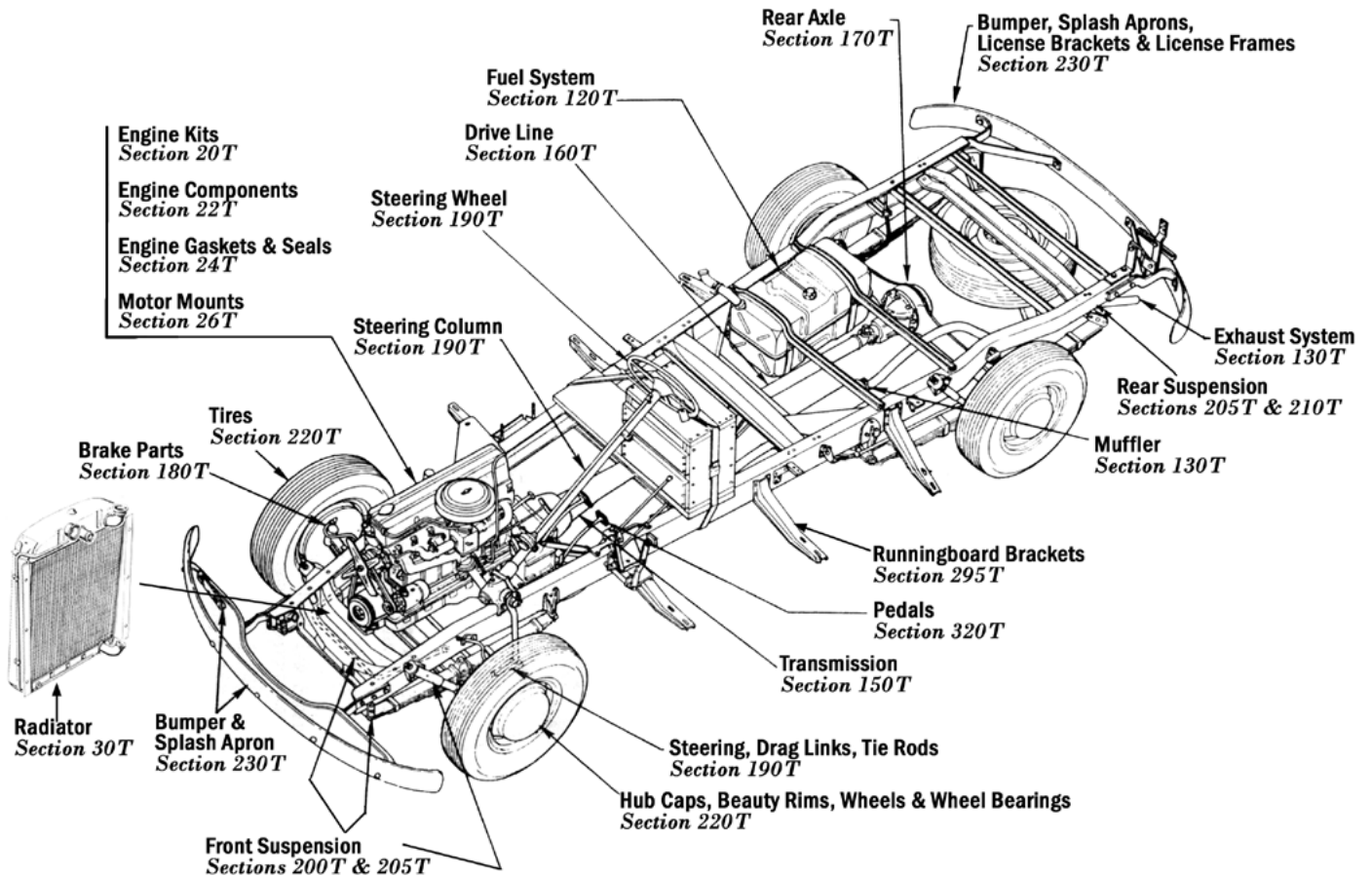

Returns require a return authorization number—Please call first. • Note: Product pricing and availability subject to change.





**Truck Sheet Metal**  
*All sheet metal can be found in Section 295T.*

**Truck Bed Parts**  
*All Truck Bed Parts can be found in Section 490T.*

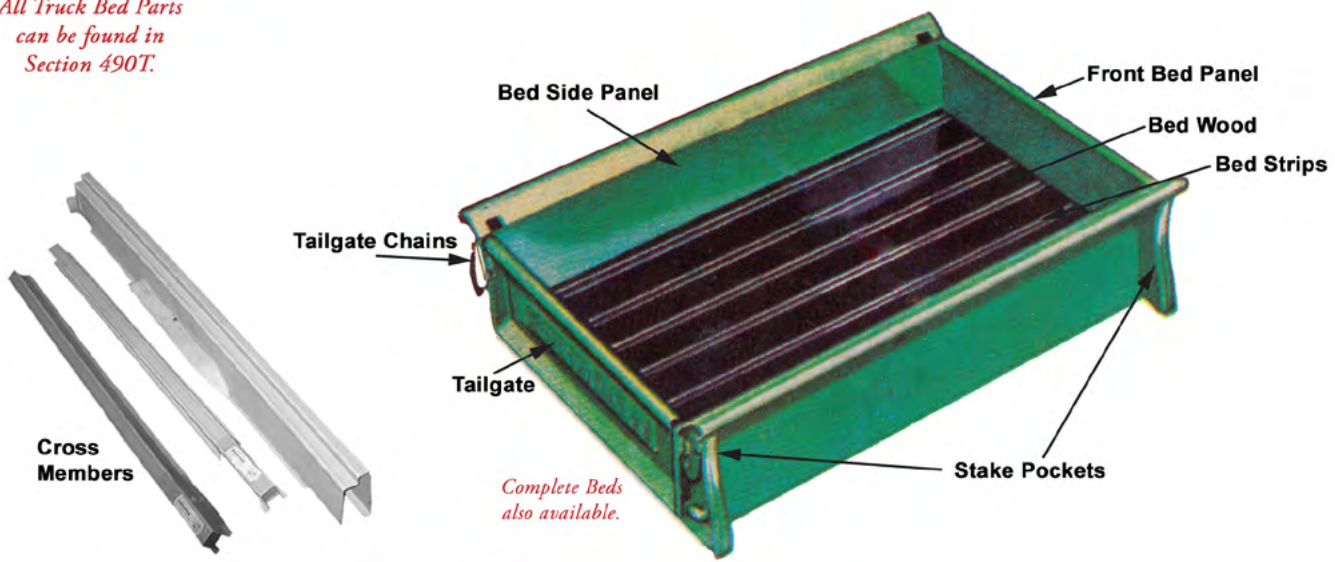

NOTE: Any chemicals will be shipped domestic ground only (Lower 48 states only). No international shipping.

## Section 5T: Series Identification Table

Series	Wheelbase	Type of Vehicle	Series	Wheelbase	Type of Vehicle
<b>1937</b>			<b>1939, continued</b>		
GA	112-1/4	Passenger (Master De Luxe) with Knee Action (Enclosed Type)	VB	133	Utility—1-1/2 Ton Truck, Dual Wheels
GB	112-1/4	Passenger and Sedan Delivery (Master)	VC	158-1/2	Utility—1-1/2 Ton Truck, Single Wheels
GC	112	Commercial—1/2 Ton Truck	VD	158-1/2	Utility—1-1/2 Ton Truck, Dual Wheels
GD	122-1/4	Commercial—3/4 Ton Truck, 11 in. Brakes	VE	107-5/8	Utility—Cab Over Engine, Single Wheels
GE	122-1/4	Commercial—1 Ton Truck	VF	107-5/8	Utility—Cab Over Engine, Dual Wheels
SA	131-1/2	Utility—1-1/2 Ton Truck, Single Wheels	VG	131-1/8	Utility—Cab Over Engine, Single Wheels
SB	131-1/2	Utility—1-1/2 Ton Truck, Dual Wheels	VH	131-1/8	Utility—Cab Over Engine, Dual Wheels
SC	157	Utility—1-1/2 Ton Truck, Single Wheels	VM	156-5/8	Utility—Cab Over Engine, Single Wheels
SD	157	Utility—1-1/2 Ton Truck, Dual Wheels	VN	156-5/8	Utility—Cab Over Engine, Dual Wheels
<b>1938</b>			<b>1940</b>		
HA	112-1/4	Passenger (Master De Luxe) with Knee Action (Enclosed Type)	KA	113	Passenger (Special De Luxe) with Knee Action (Open Spring Type)
HB	112-1/4	Passenger and Sedan Delivery (Master)	KH	113	Passenger (Master De Luxe) with Knee Action (Open Spring Type)
HC	112	Commercial—1/2 Ton Truck	KB	113	Passenger and Sedan Delivery (Master “85”), Conventional Front Axle
HD	112-1/4	Commercial—3/4 Ton Truck, 11 in. Brakes	KC	113-1/2	Commercial—1/2 Ton Truck
HE	112-1/4	Commercial—1 Ton Truck, 14 in. Brakes	KD	123-3/4	Commercial—3/4 Ton Truck, 11 in. Brakes
TA	131-1/2	Utility—1-1/2 Ton Truck, Single Wheels	KE	123-3/4	Commercial—3/4 Ton Truck, 14 in. Brakes, Heavy Duty
TB	131-1/2	Utility—1-1/2 Ton Truck, Dual Wheels	KF	133	Commercial—1 Ton Truck
TC	157	Utility—1-1/2 Ton Truck, Single Wheels	WA	133	Utility—1-1/2 Ton Truck, Single or Dual Wheels
TD	157	Utility—1-1/2 Ton Truck, Dual Wheels	WB	158-1/2	Utility—1-1/2 Ton Truck, Single or Dual Wheels
<b>1939</b>			WV	193-5/8	Utility—School Bus Chassis, Dual Wheels
JA	112-1/4	Passenger (Master De Luxe) with Knee Action (Open Spring Type)	WD	107-5/8	Utility—Cab Over Engine
JB	112-1/4	Passenger and Sedan Delivery (Master “85”)	WE	131-1/8	Utility—Cab Over Engine
JC	113-1/2	Commercial—1/2 Ton Truck	WF	156-5/8	Utility—Cab Over Engine
JD	123-3/4	Commercial—3/4 Ton Truck, 11 in. Brakes	<b>1941</b>		
JE	123-3/4	Commercial—1 Ton Truck, 14 in. Brakes (Heavy Duty)	AH	116	Passenger (Special De Luxe) with Knee Action (Open Spring Type)
VA	133	Utility—1-1/2 Ton Truck, Single Wheels	AG	116	Passenger and Sedan Delivery (Master De Luxe) with Knee Action (Open Spring Type)

Returns require a return authorization number—Please call first. • Note: Product pricing and availability subject to change.

Series	Wheelbase	Type of Vehicle
<b>1941, continued</b>		
AK	115	Commercial—1/2 Ton Truck
AL	125-1/4	Commercial—3/4 Ton Truck, 11 in. Brakes
AM	125-1/4	Commercial—3/4 Ton Truck, 14 in. Brakes, Heavy Duty
AN	134-1/2	Commercial—1 Ton Truck
YR	134-1/2	Utility—1-1/2 Ton Truck, Single or Dual Wheels
YS	160	Utility—1-1/2 Ton Truck, Single or Dual Wheels
YT	195	Utility—School Bus Chassis, Dual Wheels
YU	109	Utility—Cab Over Engine
YV	132-1/2	Utility—Cab Over Engine
YW	158	Utility—Cab Over Engine

<b>1942</b>		
BH	116	Passenger (Special De Luxe)
BG	116	Passenger and Sedan Delivery (Master De Luxe)
BK	115	Commercial—1/2 Ton Truck
BL	125-1/4	Commercial—3/4 Ton Truck, 11 in. Brakes
BM	125-1/4	Commercial—3/4 Ton Truck, 14 in. Brakes
BN	134-1/2	Commercial—1 Ton Truck
MR	134-1/2	Utility—1-1/2 Ton Truck, Single or Dual Wheels
MS	160	Utility—1-1/2 Ton Truck, Single or Dual Wheels
MY	160	Utility—School Bus Chassis, Dual Wheels
MT	195	Utility—School Bus Chassis, Dual Wheels
MU	109	Utility—Cab Over Engine
MV	132-1/2	Utility—Cab Over Engine
MW	158	Utility—Cab Over Engine

First Design	Second Design	Wheelbase	Type of Vehicle
<b>1946</b>			
		DK	116 Passenger (Fleetmaster and Fleetline)
		DJ	116 Passenger (Stylemaster)
	DP	CK	115 Commercial—1/2 Ton Truck
	DR		125-1/4 Commercial—3/4 Ton Truck
	DS		134-1/2 Commercial—1 Ton Truck

First Design	Second Design	Wheelbase	Type of Vehicle
<b>1946, continued</b>			
OR	PJ	134-1/2	Utility—1-1/2 Ton Truck
OS	PK	160	Utility—1-1/2 Ton Truck
OW	PL	160	Utility—School Bus Chassis
OY		195	Utility—School Bus Chassis
OE	PV	134-1/2	Utility—2 Ton Truck
OF	PW	160	Utility—2 Ton Truck
OG	PX	195	Utility—School Bus Chassis
OH	PP	109	Utility—2 Ton Truck, Cab Over Engine
OI	PR	132-1/2	Utility—2 Ton Truck, Cab Over Engine
OJ	PS	158	Utility—2 Ton Truck, Cab Over Engine

Series	Wheelbase	Type of Vehicle
<b>1947</b>		
EK	116	Passenger (Fleetmaster and Fleetline)
EJ	116	Passenger (Stylemaster)
EP	116	Commercial Type of Vehicles
ER	125-1/4	Commercial—3/4 Ton Truck
ES	137	Commercial—1 Ton Truck
QJ	137	Utility—1-1/2 Ton Truck
QK	161	Utility—1-1/2 Ton Truck
QL	161	Utility—School Bus Chassis
QV	137	Utility—2 Ton Truck
QW	161	Utility—2 Ton Truck
QX	199	Utility—School Bus Chassis
QP	110	Utility—2 Ton Truck, Cab Over Engine
QR	134	Utility—2 Ton Truck, Cab Over Engine
QS	158	Utility—2 Ton Truck, Cab Over Engine

<b>1948</b>		
FK	116	Passenger (Fleetmaster and Fleetline)
FJ	116	Passenger (Stylemaster)
FP	116	commercial—1/2 Ton Truck
FR	125-1/4	Commercial—1/2 Ton Truck
FT	125-1/4	Commercial—3/4 Ton Truck (Dubl-Duti), Forward Control Delivery Chassis
FS	137	Commercial—1 Ton Truck
FU	137	Commercial—1 Ton Truck (Dubl-Duti), Forward Control Delivery Chassis
RJ	137	Utility-1-Utility—1-1/2 Ton Truck
RK	161	Utility-1-Utility—1-1/2 Ton Truck

NOTE: Any chemicals will be shipped domestic ground only (Lower 48 states only). No international shipping.

## Section 5T: Series Identification Table

Series	Wheelbase	Type of Vehicle	Series	Wheelbase	Type of Vehicle
<b>1948, continued</b>			<b>1950, continued</b>		
RL	161	Utility—School Bus Chassis	TK	4400 161	Utility—1-1/2 Ton Truck
RV	137	Utility—2 Ton Truck	TLT	4500 161	Utility—School Bus Chassis
RW	161	Utility—2 Ton Truck	VS	6100 137	Utility—2 Ton Truck
RX	199	Utility—School Bus Chassis	TW	6400 161	Utility—2 Ton Truck
RP	110	Utility—2 Ton Truck, Cab Over Engine	TY	6500 179	Utility—2 Ton Truck
RR	134	Utility—2 Ton Truck, Cab Over Engine	TX	6700 199	Utility—School Bus Chassis
RS	158	Utility—2 Ton Truck, Cab Over Engine	TP	5100 110	Utility—2 Ton Truck, Cab Over Engine
<b>1949</b>			TR	5400 134	Utility—2 Ton Truck, Cab Over Engine
GK	2100 115	Passenger (Deluxe), Styleline and Fleetline	TS	5700 158	Utility—2 Ton Truck, Cab Over Engine
GJ	1500 115	Passenger (Special), Styleline and Fleetline	<b>1951</b>		
GP	3100 116	Commercial—1/2 Ton Truck	JK	2100 115	Passenger (Deluxe), Styleline and Fleetline
GR	3600 125-1/4	Commercial—3/4 Ton Truck	JJ	1500 115	Passenger (Special), Styleline and Fleetline
GT	3700 125-1/4	Commercial—3/4 Ton Truck (Dubl-Duti), Forward Control Delivery Chassis	JP	3100 116	Commercial—1/2 Ton Truck
GS	3800 137	Commercial—1 Ton Truck	JR	3600 125-1/4	Commercial—3/4 Ton Truck
GU	3900 137	Commercial—1 Ton Truck (Dubl-Duti), Forward Control Delivery Chassis	JT	3700 125-1/4	Commercial—3/4 Ton Truck (Dubl-Duti), Forward Control Delivery Chassis
SJ	4100 137	Utility—1-1/2 Ton Truck	JS	3800 137	Commercial—1 Ton Truck
SK	4400 161	Utility—1-1/2 Ton Truck	JUS	3900 137	Commercial—1 Ton Truck (Dubl-Duti), Forward Control Delivery Chassis
SL	4500 161	Utility—School Bus Chassis	UJ	4100 137	Utility—1-1/2 Ton Truck
VS	6100 137	Utility—2 Ton Truck	UK	4400 161	Utility—1-1/2 Ton Truck
SW	6400 161	Utility—2 Ton Truck	UL	4500 161	Utility—School Bus Chassis
SX	6700 199	Utility—School Bus Chassis	UV	6100 137	Utility—2 Ton Truck
SP	5100 110	Utility—2 Ton Truck, Cab Over Engine	UW	6400 161	Utility—2 Ton Truck
SR	5400 134	Utility—2 Ton Truck, Cab Over Engine	UY	6500 179	Utility—2 Ton Truck
SS	5700 158	Utility—2 Ton Truck, Cab Over Engine	UX	6700 199	Utility—School Bus Chassis
<b>1950</b>			UP	5100 110	Utility—2 Ton Truck, Cab Over Engine
HK	2100 115	Passenger (Deluxe), Styleline and Fleetline	UR	5400 134	Utility—2 Ton Truck, Cab Over Engine
HJ	1500 115	Passenger (Special), Styleline and Fleetline	US	5700 158	Utility—2 Ton Truck, Cab Over Engine
HP	3100 116	Commercial—1/2 Ton Truck	<b>1952</b>		
HR	3600 125-1/4	Commercial—3/4 Ton Truck	KK	2100 115	Passenger (Deluxe), Styleline and Fleetline
HT	3700 125-1/4	Commercial—3/4 Ton Truck (Dubl-Duti), Forward Control Delivery Chassis	KJ	1500 115	Passenger (Special), Styleline and Fleetline
HS	3800 137	Commercial—1 Ton Truck	KP	3100 116	Commercial—1/2 Ton Truck
HU	3900 137	Commercial—1 Ton Truck (Dubl-Duti), Forward Control Delivery Chassis	KR	3600 125-1/4	Commercial—3/4 Ton Truck
TJ	4100 137	Utility—1-1/2 Ton Truck	KT	3700 125-1/4	Commercial—3/4 Ton Truck (Dubl-Duti), Forward Control Delivery Chassis
			KS	3800 137	Commercial—1 Ton Truck

Returns require a return authorization number—Please call first. • Note: Product pricing and availability subject to change.

Series	Wheelbase	Type of Vehicle	Series	Wheelbase	Type of Vehicle
<b>1952, continued</b>			<b>1953-54</b>		
KI	3900 137	Commercial—1 Ton Truck (Dubl-Duti), Forward Control Delivery Chassis	A	1500 115	Passenger (One Fifty), excluding 1508
VJ	4100 137	Utility—1-1/2 Ton Truck	B	2100 115	Passenger (Two Ten)
VK	4400 161	Utility—1-1/2 Ton Truck	C	2400 115	Passenger (Bel Air)
VL	4500 161	Utility—1-1/2 Ton, School Bus Chassis	D	1508 115	Sedan Delivery
VV	6100 137	Utility—2 Ton Truck	H	3100 116	Commercial—3/4 Ton Truck
VW	6400 161	Utility—2 Ton Truck	J	3600 124-1/4	Commercial—3/4 Ton Truck (Dubl-Duti), Forward Control Delivery Chassis
VY	6500 179	Utility—2 Ton Truck	K	3700 124-1/4	Commercial—3/4 Ton Truck (Dubl-Duti), Forward Control Delivery Chassis
VX	6700 199	Utility—2 Ton Truck, School Bus Chassis	L	3800 137	Commercial—1 Ton Truck
VZ	6800 212	Utility—2 Ton Truck, School Bus Chassis	M	3900 137	Commercial—1 Ton Truck (Dubl-Duti), Forward Control Delivery Chassis
VP	5100 110	Utility—2 Ton Truck, Cab Over Engine	N	4100 137	Utility—1-1/2 Ton Truck
VR	5400 134	Utility—2 Ton Truck, Cab Over Engine	P	4400 161	Utility—1-1/2 Ton Truck
VS	5700 158	Utility—2 Ton Truck, Cab Over Engine	R	4500 161	Utility—School Bus Chassis
			S	5100 110	Utility—2 Ton Truck, Cab Over Engine
			T	5400 134	Utility—2 Ton Truck, Cab Over Engine
			U	5700 158	Utility—2 Ton Truck, Cab Over Engine
			V	6100 137	Utility—2 Ton Truck
			W	6400 161	Utility—2 Ton Truck
			X	6500 179	Utility—2 Ton Truck
			Y	6700 199	Utility—School Bus Chassis
			Z	6800 212	Utility—School Bus Chassis

**COMMERCIAL  
BODY PARTS SECTION**  
GROUPS 16.000 - 17.721  
Six Cylinder Models — 1929-1950

**KEY TO SYMBOLS**

The usage of parts listed in this section is designated either by job numbers, chassis symbols, or model abbreviations shown below:

CAB BODIES (including Cab Over Engine) . . . . . C CAB  
 CAB OVER ENGINE . . . . . COE  
 OPEN CAB . . . . . Open Cab  
 SINGLE UNIT BODIES (Panels, Canopy Express, Suburban Carryall, Etc.) . . . . . SGL UNIT  
 SUBURBAN CARRYALL BODY . . . . . SUB  
 SUBURBAN CARRYALL BODY (with End Gate) . . . . . Sub w/End Gate  
 SUBURBAN CARRYALL BODY (with Panel Doors) . . . . . Sub. w/Doors  
 DOUBLE UNIT BODIES (With Cab and Separate Body) . . . . . DBL. UNIT  
 PLAIN CHASSIS LESS WINDSHIELD . . . . . FTC or FLAT FACE COWL  
 ALL ABOVE MODELS. . . . . ALL

See Commercial Body Model Identification Sheet on Next Page for Job Numbers and Chassis Symbols. Suburban Carryall Body Parts for the years 1939-50 are now being listed in the "Master Parts Catalog" along with comparable parts. Body parts which are common to Suburban Carryall, Panels and Canopy Express, may be found listed as Single Unit or under Corresponding Commercial Body Types.

NOTE: Any chemicals will be shipped domestic ground only (Lower 48 states only). No international shipping.

## Section 5T: Series Identification Table



**1937** was the first year Chevrolet began to offer 3/4- and one-ton trucks as standard models. Chevrolet also introduced the 216 engines and increased the number of

main bearings to four. With the gas tank under the passenger seat, the seat had to be removed to fill the tank. The half-ton bed length increased from 72 to 77 inches. Other Chevrolet truck changes that year included the truck headlights attached to the radiator shell sides and the treads on the running boards ran the length of the board.



The **1938** Chevrolet truck model was much like the 1937 model. The gas tank filler changed to be extended through the cab wall from its location under the seat, and a heavier bumper with a painted streak was added. The pickup used the flat-head six-cylinder engine borrowed from Pontiac. This was the last year Chevrolet used the generator cutout.



The **1939** and 1940 Chevrolet trucks had a restyled and re-engineered cab and front sheet metal. The new models were the best-looking trucks in Chevrolet's truck division's history. The Chevy cab was designed for driver comfort and convenience. In 1939, Chevrolet launched its first cab-over-engine truck. This was also the first year Chevrolet used script lettering on the tailgate, and the last year for oval taillights.



Chevrolet continued the new design into the **1940** model year. One of the more obvious differences from the 1939 models was the uppermost

grille bar with the large Chevrolet name written in red script letters. Minor changes in the cab included the instrument panel, curved with a rectangular gauge cluster design from the passenger cars. Chevrolet also introduced the rectangular taillight and the truck bed was three inches wider.



The **1941** Chevrolet truck's front end was all new. The larger, more impressive truck had an increased wheelbase and more power. Chevy discontinued the stamped name in the tailgate that year. The longer wheelbase gave the cab area additional legroom and the seat back was reclined to a more comfortable angle. The headlight assemblies were secured to the fenders.



The **1942**, Chevrolet trucks were essentially unchanged from 1941. The government halted all automobile production in early 1942 because of World War II.

Chevrolet resumed production of civilian trucks for general sales in August, 1945. The government allowed Chevrolet to build civilian heavy-duty chassis cabs for qualified essential users in 1944 and 1945, and the half-ton 115-inch wheelbase pickup in 1945 for qualified essential civilian users.



In **1946**, Chevrolet brought a full line of light, medium, and heavy-duty trucks to the market. All the trucks that year came complete with chrome trim. The Coupe pickup was the only prewar model that didn't return. The light-duty engine was the same as the prewar engine. Only minor changes were made to the Chevy models in 1946.



**1947** saw major overhauls. The Advanced Design trucks entered production with a multitude of model changes. The new Chevys had a larger cab, more comfortable seats, and better driving vision. The gas tank was moved to under the truck bed that year. The three-inch wider bed had nine planks versus the seven from the year before. The Chevrolet name was stamped into the tailgate. The larger windshield and bigger side and rear window glass and optional rear-quarter windows greatly improved safety and driver vision.



Chevrolet only made minor changes to the models in **1948**. The transmission gear shift lever was moved to the steering column from the floor, while the parking brake was changed from a floor-mounted lever to a foot-actuated pedal.



Only minor changes were made in **1949**. The gas tank was moved into the cab behind the seat back. The Chevy hood emblem became chrome-plated steel. This was the last year Chevrolet used the lever-action shocks.



In **1950**, the 216.5 cubic-inch six-cylinder engine was tweaked to put out more horsepower. The new modern tubular shocks were introduced. The Chevrolet hood side emblems display their name plus 3100 for a 1/2-ton, 3600 on a 3/4-ton, and 3800 on a 1-ton.



In **1951**, the left-side cowl vent was eliminated and replaced with the door vent windows. The seat adjustment with the metal cable was changed to a rod under the cushion which was run through a rubber grommet and secured to the seat riser frame. In mid-year 1951, the Chevy truck bed changed from nine boards to eight. The maximum speedometer speed was 80 mph.



Push-button door handles were introduced in the **1952** model year. The Chevrolet hubcaps changed from being chrome-plated to gray painted steel with black block letters, though the stamping and shape remained the same as prior years. Some say a very few deluxe 1/2-ton pickups still carried the chrome hubcap. The truck speedometer showed a maximum speed of 90 mph.



In **1953** the Chevrolet truck hood emblem was stainless steel. This was the first year Chevy offered the optional left side mount spare tire on the pickups. This was also the last year for wood blocks under the truck bed.



In **1954** Chevrolet introduced the one-piece windshield, an all-new grille, new parking lights, a new steering wheel, and a redesigned dashboard, the new high-pressure 235 cubic-inch insert-bearing engine on the pickups, and the 261 cubic-inch six-cylinder on large trucks. The Chevy hubcaps had the same shape as before; however, they had only the bowtie emblem. The redesigned bed changed to increase the bed depth with all new bed sides. The optional rear bumper was dropped in the center to make room for a new license plate location.

## Section 8T: Paint Combination Chart

Body		Moulding		Stripe	
<b>1937-39</b>					
242	Swifts Commercial Red	225	—	Argent Silver	2894202
243	Export Blue	314	—	Argent Silver	2894202
244	Brewster Green Med.	267	—	Gigolo Green	2899862
<b>1940-46</b>					
242	Swifts Commercial Red		Black Duco	2072122	Argent Silver
269	Boatswain Blue		Argent Silver	2894202	Totem Scarlet
257	Apple green		Cream Medium	2896596	Emerald Green
312	Amour Yellow		Omaha Orange	2896276	Moulding Black
234	Cream Medium		Export Blue	2897128	Argent Silver
314	Export Blue		Argent Silver	2894202	Totem Scarlet
262	Omaha Orange		Chess Blue	28950666	White Striping
313	Aluminum (Silver)		Totem Scarlet	28950165	Moulding Black
<b>Most Common Colors</b>					
	Brewster Green		1940 uses Cream Medium		1940 uses Emerald Green
	Black		Kildaire Green	28950701	Emerald Green
			Emerald Green	2893133	Cream Medium
			1940 uses Omaha Orange		1940 uses Chess Blue
264	White		Kildaire Green	28950701	White Striping
301	Hollywood Tan (Oakland Plant)		Moulding Black	2072122	White Striping
	Bordeaux Maroon (Terrytown and Baltimore Plants)		Moulding Black	2072122	Gold Bronze Powder
<b>Upper Body</b>		<b>Lower Body</b>		<b>Moulding</b>	
<b>1941-46 Suburban</b>					
	Airdale Brown		Circassion Brown		Kildaire Green
				28950701	White Striping
					289008
<b>Body</b>		<b>Moulding</b>		<b>Stripe</b>	
<b>1947-49</b>					
	Fathom Green		—		—
<b>1947-53</b>					
	Windsor Blue		—		—
	Cape Maroon		—		—
	Swift Red (Commercial Red)		—		—
	Armour Yellow		—		—
	Sun Beige		—		—
	Forester Green		—		—
	Seacrest Green		—		—
<b>1947-55</b>					
	Omaha Orange (GMC)		—		Jet Black
	Cream Medium		—		Jet Black
	Mariner Blue		—		Cream Medium
	White		—		Juniper Green
<b>1948-49</b>					
	Channel Green		—		—
<b>1951-55</b>					
	Yukon Yellow		—		Jet Black
	Burgundy Maroon		—		Gold Bronze
	Copper Tone		—		Shell White
	Ocean Green		—		Jet Black
	Autumn Brown		—		Shell White
	Transport Blue		—		Cream Medium
	Juniper Green		—		Cream Medium

Returns require a return authorization number—Please call first. • Note: Product pricing and availability subject to change.



**SECTION 010T  
RESTORATION PARTS**

**Gift Certificates**



**GIFTCERT0025 . . . . . ALL**  
\$25 Gift Certificate -0

**\$25.00 EA** ⚠️

**GIFTCERT0050 . . . . . ALL**  
\$50 Gift Certificate -0

**\$50.00 EA** ⚠️

**GIFTCERT0075 . . . . . ALL**  
\$75 Gift Certificate -0

**\$75.00 EA** ⚠️

**GIFTCERT0100 . . . . . ALL**  
\$100 Gift Certificate -0

**\$100.00 EA** ⚠️

**GIFTCERT0150 . . . . . ALL**  
\$150 Gift Certificate -0

**\$150.00 EA** ⚠️

**GIFTCERT0200 . . . . . ALL**  
\$200 Gift Certificate -0

**\$200.00 EA** ⚠️

**GIFTCERT0500 . . . . . ALL**  
\$500 Gift Certificate -0

**\$500.00 EA** ⚠️

**GIFTCERT1000 . . . . . ALL**  
\$1000 Gift Certificate -0

**\$1,000.00 EA** ⚠️

**GIFTCERT5000 . . . . . ALL**  
\$5000 Gift Certificate -0

**\$5,000.00 EA** ⚠️

**Fender/Trunk Script Emblems**

*Streetrod*

**R6273 . . . . . ALL**  
"Streetrod" Emblem -0.15 **\$7.25 EA** ⚠️

*Hotrod*

**R6274 . . . . . ALL**  
"Hotrod" Emblem -0.2 **\$11.50 EA** ⚠️

*Blown*

**R6276 . . . . . ALL**  
"Blown" Emblem -0.15 **\$8.75 EA** ⚠️

**Fender/Trunk Script Emblems, cont.**

*Cruisin*

**R6277 . . . . . ALL**  
"Cruisin" Emblem -0.15 **\$6.75 EA** ⚠️

*Turbocharged*

**R6278 . . . . . ALL**  
"Turbocharged" Emblem -0.15 **\$7.75 EA** ⚠️

**Vehicle Accessories**



**10887 . . . . . ALL**  
Chrome bullet wing nut license fastener. Set of 4 -0.15 **\$5.25 SET** ⚠️



**8BALL70204 . . . . . ALL**  
Fuzzy 8 Ball Black -0.15 **\$7.00 EA** ⚠️



**985094 . . . . . ALL**  
Glass jewel reflector. Specify Red, Green, Blue, Amber, Burnt Orange, Purple, Clear, Light Blue, Yellow, Rainbow. (2 pcs). 9.777 -0.2 **starting at \$20.00 PR** ⚠️



**DICE . . . . . ALL**  
Classic Fuzzy Dice, Chose Black, Blue or Red -0.15 **\$5.00 PR** ⚠️

**Vehicle Accessories, cont.**



**DLK70023 . . . . . ALL**  
8 Ball Door Lock Knob -0.15 **\$7.50 PR** ⚠️



**DLK70044 . . . . . ALL**  
Chrome Metal Tube Door Lock Knob -0.2 **\$7.25 PR** ⚠️



**FELIX . . . . . ALL**  
Universal Felix the cat license frame ornament. -0.15 **\$20.75 EA** ⚠️



**FLAG01 . . . . . ALL**  
License Plate Frame Accessory, U.S.A. Flag -0.4 **\$1.75 EA** ⚠️



**FLAG02 . . . . . ALL**  
Flag Holder - 5 Post -0.15 **\$10.75 EA** ⚠️



**FLAG03 . . . . . ALL**  
Flag Holder-Chrome 3 Post -0.15 **\$9.50 EA** ⚠️



**WARNING:** Cancer and Reproductive Harm — [www.P65Warnings.ca.gov](http://www.P65Warnings.ca.gov)

Chemicals shipped domestic ground only (Lower 48 states only). No international shipping.

**Phone: (360) 816-0211 • (800) 999-CHEV (2438) • [www.chevsofthe40s.com](http://www.chevsofthe40s.com)**

# Section 010T: Gift Items, Collectibles, Truck Covers & Vehicle Maintenance

## Vehicle Accessories, cont.



**LF70045**.....**ALL**  
8 Ball License Plate Fastener -0.2 ...  
**\$6.50 PR** ⚠



**LF70065**.....**ALL**  
Lion Head License Plate Fastener -0.2  
.....**\$7.25 PR** ⚠



**LF70070**.....**ALL**  
Chrome Dice License Plate Fastener -0.2  
.....**\$6.00 PR** ⚠



**LF70071**.....**ALL**  
Chrome Bullet License Plate Fastener -0.2  
.....**\$8.75 PR** ⚠



**LF70072**.....**ALL**  
Dice License Plate Fastener Green With  
White Dots -0.15 .....**\$5.00 PR** ⚠

## Vehicle Accessories, cont.



**LF70073**.....**ALL**  
Dice License Plate Fastener Purple With  
White Dots -0.15 .....**\$5.00 PR** ⚠



**LF70074**.....**ALL**  
Large 8 Ball License Plate Fastener -0.15  
.....**\$7.00 PR** ⚠



**LF70096**.....**ALL**  
Iron Cross License Plate Fastener -0.15  
.....**\$6.00 PR** ⚠



**LF70315**.....**ALL**  
Chrome Skull License Plate Fastener -0.15  
.....**\$4.25 PR** ⚠



**VC69978**.....**ALL**  
Chrome Large 8 Ball Valve Cap -0.2  
**\$10.25 SET** ⚠



**VC69981**.....**ALL**  
Chrome Dice Valve Caps -0 **CALL** ⚠

## Vehicle Accessories, cont.



**VC70004**.....**ALL**  
Skull Valve Caps -0.15 .....**\$7.25 SET** ⚠



**VC70005**.....**ALL**  
Dice Valve Caps-Red With White Dots -0.15  
.....**\$4.25 SET** ⚠



**VC70006**.....**ALL**  
Dice Valve Caps-White With Black  
Dots -0.15 .....**\$4.00 SET** ⚠



**VC70007**.....**ALL**  
Dice Valve Caps-Black With White  
Dots -0.15 .....**\$4.00 SET** ⚠



**VC70008**.....**ALL**  
Dice Valve Caps- Blue With White  
Dots -0.15 .....**\$4.00 SET** ⚠



**VC70022**.....**ALL**  
8 Ball Valve Caps -0.15 .....**\$4.00 SET** ⚠

Returns require a return authorization number—call first. • Product pricing & availability subject to change.



**WARNING:** Cancer and  
Reproductive Harm —  
[www.P65Warnings.ca.gov](http://www.P65Warnings.ca.gov)

**Vehicle Accessories, cont.**



**VC70038** .....ALL  
 Chrome Spike Valve Caps -0.15 .....  
**\$8.25 SET** ⚠️



**VINTAGE01** ....ALL  
 Registration holder for your column w/ springs. 5-1/4" X 3-1/4" -0.15  
 ..... **\$12.00 EA** ⚠️



**VINTAGE02** .....ALL  
 Registration holder w/ clamps for your Sun Visor. Reproduction protector for your registration card. 5-1/4" x 3-3/8" -0.15  
 ..... **\$13.00 EA** ⚠️



**WASITFD** .....ALL  
 Bluetooth speaker fuzzy dice. Easy setup with built in microphone & stereo speakers makes hands free calling safe & easy. Works with your

smart phone for calling, music, navigation & more. Rechargeable long play battery. USB charging cord included. Great in the shop or at cruise nights too. -0.15  
 ..... **\$109.00 EA** ⚠️

**Hoodies**



**HOODIE-CH1** ...ALL  
 Large or XL cotton hoodies with Chevs chest logo. Choose Black, Grey, Navy or Red. 0.000-0.15  
 ..... **\$24.50 EA** ⚠️

**Hoodies, cont.**

**HOODIE-CH2** ..... ALL  
 XXL (Black, Navy or Grey) or XXXL (Black or Navy). Single Chevs logo on left chest. 0.000 -0  
 ..... **\$24.50 EA** ⚠️

**T-Shirts**

**SHIRT01** .....ALL  
 Chevs Logo T-Shirt. Available in Red, White, Blue or Black. S, M, L, XL, XXL, XXXL -0.15  
 ..... **\$15.00 EA** ⚠️



**SHIRT03** .....ALL  
 '41 Cabriolet Art. Available in Black or Red. S, M, L, XL, XXL, XXXL -0.15  
 ..... **\$15.00 EA** ⚠️



**SHIRT04** .....ALL  
 '41 Cabriolet "Bustin Through". Available in Black or Blue. S, M, L, XL, XXL, XXXL -0.15  
 ..... **\$15.00 EA** ⚠️



**SHIRT07** .....ALL  
 47-53 Truck "Bustin Through". Available in black or blue, S, M, L, XL, XXL, XXXL -0.15  
 ..... **\$15.00 EA** ⚠️



**SHIRT08** .....ALL  
 T-Shirt "52 Bustin' Through". Available in black or blue, S, M, L, XL, XXL, XXXL -0.15  
 ..... **\$15.00 EA** ⚠️



**SHIRT09** .....ALL  
 T-Shirt "39 Bustin' Through". Available in black or blue, S, M, L, XL, XXL, XXXL -0.15  
 ..... **\$17.50 EA** ⚠️

**T-Shirts, cont.**



**SHIRT10** .....ALL  
 T-Shirt "37 Bustin' Through". Available in black or blue, S, M, L, XL, XXL, XXXL -0.15  
 ..... **\$15.75 EA** ⚠️



**SHIRT11** .....ALL  
 T-Shirt "40 Bustin' Through". Available in black or red, S, M, L, XL, XXL, XXXL -0.15  
 ..... **\$15.00 EA** ⚠️



**SHIRT13** .....ALL  
 Street Rod Headquarters basic Available in black, S, M, L, XL, XXL, XXXL -0  
 ..... **\$15.00 EA** ⚠️

**Hats**



**HAT-CHEVS1B** .....ALL  
 Black preformed ball cap with Chevs embroidered logo and red, white & blue detailing on brim. One size fits all with velcro closure. -0.15  
 ..... **\$14.00 EA** ⚠️



**HAT-CHEVS1N** .....ALL  
 Navy preformed ball cap with Chevs embroidered logo and red, white & blue detailing on brim. One size fits all with velcro closure. -0.15  
 ..... **\$14.00 EA** ⚠️



**HAT-CHEVS2** .....ALL  
 Beanie/ Stocking cap 8". Navy with Chevs embroidered logo. One size fits all. -0.15  
 ..... **\$14.00 EA** ⚠️



**HAT-CHEVS3** .....ALL  
 Beanie/ Stocking cap 12". Navy with Chevs embroidered logo. One size fits all. -0.15  
 ..... **\$14.00 EA** ⚠️

**HAT-CHEVS4** .....ALL  
 Beanie/ Stocking cap 12". Black with Chevs embroidered logo. One size fits all. -0.15  
 ..... **\$14.00 EA** ⚠️



**WARNING:** Cancer and Reproductive Harm — [www.P65Warnings.ca.gov](http://www.P65Warnings.ca.gov)

Chemicals shipped domestic ground only (Lower 48 states only). No international shipping.

**Phone: (360) 816-0211 • (800) 999-CHEV (2438) • [www.chevsofthe40s.com](http://www.chevsofthe40s.com)**

**Hats, cont.**



**HAT-CHEVS5 . . . . .ALL**  
 Beanie/ Stocking cap  
 8". Black with Chevs  
 embroidered logo. One  
 size fits all. -0.15  
 . . . . . **\$14.00 EA** ⚠️

**Model 1:6 Scale Chevy Small Block**



**MODEL12SR . . . . .ALL**  
 Produced by Liberty Classic. Cool scaled  
 rendition of a tried-and-true classic  
 (limited quantity). 0.000 -0.15  
 . . . . . **\$36.50 EA** ⚠️

**Vintage Chevrolet Cooler**



**BLACKCOOLER . . . . .ALL**  
 Black beverage cooler. 16-1/2" x 7-1/2" x  
 9-3/8" internal dimensions. 0.000 -0  
 . . . . . **\$79.00 EA** ⚠️



**BLUECOOLER . . . . .ALL**  
 Blue beverage cooler. 16-1/2" x 7-1/2" x  
 9-3/8" internal dimensions. 0.000 -0  
 . . . . . **\$79.00 EA** ⚠️



**REDCOOLER . . . . .ALL**  
 Red beverage cooler. 16-1/2" x 7-1/2" x  
 9-3/8" internal dimensions. 0.000 -0  
 . . . . . **\$79.00 EA** ⚠️

**Artwork**



**ART3 . . . . .ALL**  
 Chevy Farm. 15" X 30" color print of  
 classic cars. Limited print run of 650.  
 0.000 -0.15 . . . . . **\$75.00 EA** ⚠️

**Neon Marquee Sign 10 Foot Length**



**NEON120CO . . . . .ALL**  
 10 Feet Long! "Chevrolet Corvette Garage"  
 in Red, Black & Yellow. -0 . . . . .  
**\$5,500.00 EA** ⚠️



**NEON120UC . . . . .ALL**  
 10 Feet Long! OK Used Cars in Red &  
 Yellow. -0 . . . . . **\$5,500.00 EA** ⚠️

**Neon Marquee Sign & Clock 72" Length**



**NEON72SS-BW . . . . .ALL**  
 6' long x 26" tall. -0 . . . . . **\$1,695.00 EA**  
 ⚠️



**NEON72SV-BLK . . . . .ALL**  
 6' long x 26" tall. -0 . . . . . **\$1,695.00 EA**  
 ⚠️

**Neon Marquee Sign & Clock 72" Length, cont.**



**NEON72SV-YEL . . . . .ALL**  
 6' long x 26" tall. -0 . . . . . **\$1,695.00 EA**  
 ⚠️



**NEON72UC-YEL . . . . .ALL**  
 6' long x 26" tall. -0 . . . . . **\$1,695.00 EA**  
 ⚠️

**Neon Marquee Sign 48" Length**



**NEON48G-BLK . . . . .ALL**  
 "ROUTE 66 GARAGE", 48" long x 24" tall,  
 8" deep. -0.15 . . . . . **\$995.00 EA** ⚠️



**NEON48G-GRN . . . . .ALL**  
 "LAST CHANCE GARAGE", 48" long x 24"  
 tall, 8" deep. -0.15 . . . . . **\$995.00 EA** ⚠️



**NEON48G-YEL . . . . .ALL**  
 "CHEVROLET PARTS GARAGE", 48" long x  
 24" tall, 8" deep. -0.15 . . . . . **\$995.00 EA**  
 ⚠️

Returns require a return authorization number—call first. • Product pricing & availability subject to change.

**WARNING:** Cancer and Reproductive Harm — [www.P65Warnings.ca.gov](http://www.P65Warnings.ca.gov)

**Neon Marquee Sign 48" Length, cont.**



**NEON48S-GRN** .....ALL  
 "LAST CHANCE GARAGE SERVICE", 48"  
 long x 24" tall, 8" deep. -.15 .....  
**\$995.00 EA** ⚠️



**NEON48S-YEL** .....ALL  
 "CHEVROLET SERVICE", 48" long x 24"  
 tall, 8" deep. -.15 ... **\$995.00 EA** ⚠️



**NEON48UC-YEL** .....ALL  
 "OK USED CARS", 48" long x 24" tall, 8"  
 deep. -.15 ..... **\$995.00 EA** ⚠️

**Neon Marquee Sign 34" Length**



**NEON34PG-BLK** .....ALL  
 "POLLY GAS", 34" long x 24" tall, 8"  
 deep. -.15 ..... **\$950.00 EA** ⚠️

**Wall Clocks**

Neon to light up your garage, den, workshop or anywhere you can find a place for these large clocks.



**CLOCK01GMMPALL**  
 Antique Sinclair  
 Green Neon -.15  
 ..... **\$159.00 EA** ⚠️

**Wall Clocks, cont.**



**CLOCK01RMMPALL**  
 Antique Sinclair Red  
 Neon -.15  
 ..... **\$159.00 EA** ⚠️



**CLOCK02MMP** .ALL  
 Chevy Garage Blue  
 Neon -.15  
 ..... **\$165.00 EA** ⚠️



**CLOCK03MMP** .ALL  
 Ford Motor Co Blue  
 Neon -.15  
 ..... **\$159.00 EA** ⚠️



**CLOCK04MMP** .ALL  
 Gear Head Blue  
 Neon -.15  
 ..... **\$159.00 EA** ⚠️



**CLOCK05MMP** .ALL  
 Genuine Chevy Parts  
 Blue Neon -.15  
 ..... **\$159.25 EA** ⚠️



**CLOCK06MMP** .ALL  
 GMC Truck White  
 Neon -.15  
 ..... **\$159.00 EA** ⚠️



**CLOCK07MMP** .ALL  
 GULF Blue  
 Neon -.15  
 ..... **\$159.00 EA** ⚠️

**Wall Clocks, cont.**



**CLOCK08BMMPALL**  
 Mobile Gas Blue  
 Neon -.15  
 ..... **\$159.00 EA** ⚠️



**CLOCK08RMMPALL**  
 Mobile Gas Red  
 Neon -.15  
 ..... **\$159.00 EA** ⚠️



**CLOCK09MMP** .ALL  
 Moon Eyes Yellow  
 Neon -.15  
 ..... **\$159.25 EA** ⚠️



**CLOCK10MMP** .ALL  
 Penzoil Red  
 Neon -.15  
 ..... **\$159.00 EA** ⚠️



**CLOCK11MMP** .ALL  
 Road Runner Orange  
 Neon -.15  
 ..... **\$159.00 EA** ⚠️



**CLOCK12MMP** .ALL  
 Corvette Garage Red  
 Neon -.15  
 ..... **\$159.00 EA** ⚠️



**CLOCK13MMP** .ALL  
 Genuine Ford Parts  
 Blue Neon -.15  
 ..... **\$159.25 EA** ⚠️



Chemicals shipped domestic ground only (Lower 48 states only). No international shipping.

Phone: (360) 816-0211 • (800) 999-CHEV (2438) • [www.chevofthe40s.com](http://www.chevofthe40s.com)

**Wall Clocks, cont. , cont.**



**CLOCK14MMP .ALL**  
Poly Gas Green  
Neon -0.15  
..... **\$159.00 EA** ⚠



**CLOCK15MMP .ALL**  
Pontiac Service Red  
Neon -0.15  
..... **\$159.00 EA** ⚠



**CLOCK16MMP .ALL**  
Sunoco Gas Yellow  
Neon -0.15  
..... **\$159.00 EA** ⚠



**CLOCK17MMP .ALL**  
76 Gas Blue  
Neon -0.15  
..... **\$159.00 EA** ⚠



**CLOCK18MMP .ALL**  
Olds Rocket Red  
Neon -0.15  
..... **\$159.00 EA** ⚠



**CLOCK19MMP .ALL**  
Rat Fink Green  
Neon -0.15  
..... **\$159.25 EA** ⚠



**CLOCK20MMP .ALL**  
HURST Red  
Neon -0.15  
..... **\$159.00 EA** ⚠

**Wall Clocks**



**CLOCK21MMP .ALL**  
Super Chevy Service  
Yellow Neon -0.15  
..... **\$159.00 EA** ⚠



**CLOCK22MMP .ALL**  
Gilmore Gas red  
Neon -0.15  
..... **\$159.00 EA** ⚠



**CLOCK23BMMPALL**  
OK Used Cars Blue  
Neon -0.15  
..... **\$159.00 EA** ⚠



**CLOCK23RMMPALL**  
OK Used Cars Red  
Neon -0.15  
..... **\$159.00 EA** ⚠

**Wall Sign**



**CHEVYGAR . . . . .ALL**  
Polished stainless steel, laser cut "Chevy Garage" wall sign. 32" x 13" tall. Great for any garage, office or game room. -0.15  
**\$63.75 EA** ⚠

**Stools**



**STOOLB1 . . . . .ALL**  
Buick Service.  
0.000 -0.15  
..... **\$105.00 EA** ⚠

**Stools, cont.**



**STOOLB2 . . . . .ALL**  
Chevy Bowtie.  
0.000 -0.15  
..... **\$105.00 EA** ⚠



**STOOLB3 . . . . .ALL**  
Belair w/ backrest.  
0.000 -0.15  
..... **\$150.00 EA** ⚠



**STOOLG1 . . . . .ALL**  
GMC Trucks.  
0.000 -0.15  
..... **\$105.00 EA** ⚠



**STOOL01 . . . . .ALL**  
Oldsmobile Service.  
0.000 -0.15  
..... **\$105.00 EA** ⚠



**STOOLP . . . . .ALL**  
Chevrolet Parts.  
Yellow, red and blue swivel seat.  
0.000 -0.15  
..... **\$105.00 EA** ⚠



**STOOLP1 . . . . .ALL**  
Pontiac Service.  
0.000 -0.15  
..... **\$105.00 EA** ⚠



**STOOLPB . . . . .ALL**  
Chevrolet Parts.  
Yellow, red and blue swivel with backrest.  
0.000 -0.15  
..... **\$150.00 EA** ⚠

Returns require a return authorization number—call first. • Product pricing & availability subject to change.



**WARNING:** Cancer and Reproductive Harm — [www.P65Warnings.ca.gov](http://www.P65Warnings.ca.gov)

**Stools, cont.**



**STOOLS .....ALL**  
Chevrolet Service stool. Blue and white swivel seat.  
0.000 -0.15  
..... **\$100.00 EA** ⚠️



**STOOLSB .....ALL**  
Chevrolet Service. Blue and white swivel seat with backrest. 0.000 -0.15  
..... **\$150.00 EA** ⚠️

**Car Wash & Cleaners**



**ADPD001 .....ALL**  
"Car Shampoo"  
Adam's soap, specially-formulated Car Wash Soap is pH-balanced

and won't strip the protective coating off your finish. This soap suds like crazy and is biodegradable. New formula can be used in a foam gun or foam cannon. 16 oz. bottle. 8.800 -0.15

..... **\$11.00 EA** ⚠️



**ADPD011 .....ALL**  
"CARPET & UPHOLSTERY CLEANER", Adam's Non-toxic, non-allergenic cleaner. Contains no soap and will not create suds. 8.800 -0.15

..... **\$13.00 EA** ⚠️



**ADPD012 .....ALL**  
"GLASS CLEANER", Adam's Glass Cleaner out performs the competition and you will love it. 16oz. spray bottle. 8.800 -0.15

..... **\$15.25 EA** ⚠️

**Car Wash & Cleaners, cont.**



**ADPD014 .....ALL**  
"UNDERCARRIAGE SPRAY" Adam's All Purpose Cleaner. Don't let ugly, soiled wheel wells ruin your beautiful detail job! Spray Adams All Purpose Cleaner in your fender wells and give them a good scrubbing with a fender brush. Let the cleaner dwell while you clean the tire and wheel, then give everything a thorough rinsing. After washing, allow to air dry, blow dry or towel dry then spray a light coating of Invisible Undercarriage Spray to all areas of the fender well, then work the product in with an old towel. When you're finished, your black fender well liners will have a perfect satin black finish. Works great for engine bays too!! 16oz. spray bottle. 8.800 -0.15

..... **\$14.00 EA** ⚠️



**ADPD015 .....ALL**  
"ALL-PURPOSE CLEANER", Adam's heavy duty w/ lemon scent. Tough on dirt but easy on your car. Cleans wheels, tires, engines, and more. Safely cleans your foam buffing & polishing pads. 16oz. Spray bottle. 8.800 -0.15

..... **\$11.75 EA** ⚠️



**ADPDWC16 .....ALL**  
"DEEP WHEEL CLEANER" the ultimate way to remove stubborn brake dust and metallic contamination from your wheels. Adam's 36oz. spray. 8.800 -0.15

..... **\$19.25 EA** ⚠️



**ADPDWC1GAL ...ALL**  
"DEEP WHEEL CLEANER" the ultimate way to remove stubborn brake dust and metallic contamination from your wheels. Adam's 1 Gallon 8.800 -0.15

..... **\$70.00 EA** ⚠️



**ADPG001 .....ALL**  
"CAR Shampoo"  
Adam's soap, specially-formulated Car Wash Soap is pH-balanced

and won't strip the protective coating off your finish. This soap suds like crazy and is biodegradable. New formula can be used in a foam gun or foam cannon. 1 gallon. 8.800 -0.15

..... **\$46.75 EA** ⚠️

**Car Wash & Cleaners, cont.**



**ADPK002 .....ALL**  
"ESSENTIALS KIT". Adam's Packaged in a clear, 4-1/4 gallon detail bucket with a spin-off, sealable lid which doubles as a stool for detailing. This Kit Includes: Signature high-suds -P-H-neuatural car wash soap, Clay bar, Detail spray, V.R.T., Revive Polish, Scratch & swirl remover, Butter wax, 2- Microfiber towels, Applicator pads, Detail sponges & 1-Plush wash pad. Save money with this kit over buying individual items, While supplies last.  
8.800 -0.15 ..... **\$199.75 SET** ⚠️



**ADPTID16 .....ALL**  
"TOTAL INTERIOR DETAILER SPRAY" is your one step solution for a clean, dressed, and factory looking interior. Adam's 16 oz. bottle. 8.800 -0.15

..... **\$14.00 EA** ⚠️



**ADPTID1GAL .....ALL**  
"TOTAL INTERIOR DETAILER" is your one step solution for a clean, dressed, and factory looking interior. Adam's 1 Gallon. 8.800 -0.15

..... **\$46.75 EA** ⚠️

**Wax & Polish**



**ADPD004 .....ALL**  
"REVIVE HAND POLISH", removes moderate oxidation, swirl marks, and fading, Adam's 14 ounces. 8.800 -0.15

..... **\$17.75 EA** ⚠️



**ADPD005 .....ALL**  
"SWIRL & HAZE REMOVER", Adam's 16 oz. Not a rubbing compound and less abrasive than toothpaste. Gently removes scratches from clearcoats and painted surfaces. For use by hand or machine. For best results, combine with Revive Polish. 8.800 -0.15

..... **\$26.00 EA** ⚠️

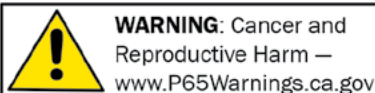

Chemicals shipped domestic ground only (Lower 48 states only). No international shipping.

**Phone: (360) 816-0211 • (800) 999-CHEV (2438) • [www.chevofthe40s.com](http://www.chevofthe40s.com)**

**Wax & Polish, cont.**



**ADPD006 .....ALL**  
 "BUTTER WAX", Adam's 16 oz. bottle. Contains special blend of polymers, resins

and natural Carnauba without cleaners or abrasives and will not stain plastic or rubber. Use Clay Bar and Revive Polish on imperfect finishes before applying Butter Wax. 12-oz bottle covers many vehicles. 8.800 -0.15

..... **\$23.50 EA** ⚠



**ADPD007 .....ALL**  
 "BRILLIANT GLAZE", Adam's 16 oz. bottle. Add depth and clarity to chrome, glass and

paintwork. Extreme ease of use with ultra-high gloss results. Not for use on oxidized finishes. 8.800 -0.15

..... **\$29.25 EA** ⚠



**ADPD017 .....ALL**  
 "FINE MACHINE POLISH", Adam's 16 oz. Polish your car's clearcoat to a jewel-like

finish. Designed for application by dual-action car polishers. After just one or two uses, your clearcoat will have perfect clarity so you can enjoy all of the rich color below. Use it several times a year to maintain perfect gloss, without thinning your clearcoat.

To protect your finely polished finish, follow up with Machine Super Wax or Buttery Wax. Both products will add additional gloss, depth and rich color. 8.800 -0.15

..... **\$25.00 EA** ⚠



**ADPD018 .....ALL**  
 "MACHINE SUPER SEALANT", Protect your paint for months in just a matter of minutes.

Easy application and built to last through the toughest elements.. 16oz. 8.800 -0.15

..... **\$26.75 EA** ⚠

**Metal Polish**



**ADPD009 .....ALL**  
 "METAL POLISH #1" Adam's Works on stainless, brass, billet, chrome, and nickel (for

use on non-clear coated parts). 8.800 -0.15

..... **\$23.50 EA** ⚠

**Metal Polish, cont.**



**ADPD010 .....ALL**  
 "METAL POLISH #2", Adam's contains no abrasives. Highest gloss metal polish on the

market w/ effortless application. Keep a mirror-like finish on brass, stainless, billet, nickel, and chrome. 8.800 -0.15

..... **\$43.00 EA** ⚠

**Dressing & Conditioners**



**ADPD002LR ....37-64**  
 Pumpkin spice scented "DETAIL SPRAY", Adam's 16 oz. bottle. We use this spray

and it works! A waterless car wash, clay bar lubricant or to enhance the depth and clarity of paint, chrome, plastic, aluminum, and glass. Removes dirt, smudges and grime, leaving surfaces with a smooth, ultra-high gloss finish. Use in the sun or shade, and in hot or cool temperatures. 8.800 -0.15

..... **\$13.00 EA** ⚠



**ADPD020 .....37-64**  
 "H2O Guard & Gloss" Adam's 16oz spray bottle. Delivers lasting protection and

unmatched gloss in a unique water-activated formula that's fast and easy to apply. The patented blend of acrylic resins and water activated nano-polymers leaves your paint slick and protected. The optical grade resins and detergent resistant polymers provide months of protection for any exterior surface including paint, trim, and glass. -0.15

..... **\$17.00 EA** ⚠



**ADPD002 .....ALL**  
 "DETAIL SPRAY", Adam's 16 oz. bottle. We use this spray and it works! A waterless

car wash, clay bar lubricant or to enhance the depth and clarity of paint, chrome, plastic, aluminum, and glass. Removes dirt, smudges and grime, leaving surfaces with a smooth, ultra-high gloss finish. Use in the sun or shade, and in hot or cool temperatures. 8.800 -0.15

..... **\$15.00 EA** ⚠

**Dressing & Conditioners, cont.**

**ADPD002C.....ALL**  
 "DETAIL SPRAY", Adam's 16 oz. bottle. We use this spray and it works! A waterless car wash, clay bar lubricant or to enhance the depth and clarity of paint, chrome, plastic, aluminum, and glass. Removes dirt, smudges and grime, leaving surfaces with a smooth, ultra-high gloss finish. Use in the sun or shade, and in hot or cool temperatures. 8.800 -0 .. **\$15.00 EA** ⚠



**ADPD003 .....ALL**  
 "V.R.T." RUBBER DRESSING, Adam's 12 oz. bottle. Enhance & protect plastic, rubber,

tires, moldings, dashboards and door panels. Applies easily with a sponge without a greasy film. Adds U.V. protection to keep vehicle interiors and exteriors looking and feeling like new. 8.800 -0.15

..... **\$23.50 EA** ⚠



**ADPD008 .....ALL**  
 "LEATHER CONDITIONER", Adam's Nourish and conditions leather upholstery with

this thick, non-greasy cream. Contains U.V. blocking agents and will never dry your leather. 16 oz. bottle. 8.800 -0.15

..... **\$29.25 EA** ⚠



**ADPD013 .....ALL**  
 "IN & OUT SPRAY", Adam's restores badly faded plastic, rubber, flat painted surfaces

and AC vents to their original luster and shine. 8.800 -0.15

..... **\$16.00 EA** ⚠



**ADPD016 .....ALL**  
 "TIRE SHINE" Adam's Tire Shine gives you a Lustrous deep and Long lasting Shine or the Wet

look. 8.800 -0.15

..... **\$17.50 EA** ⚠



**ADPG002 .....ALL**  
 "DETAIL SPRAY", Adam's 1 gallon refill. We use this spray and it works! A waterless

car wash, clay bar lubricant or to enhance the depth and clarity of paint, chrome, plastic, aluminum, and glass. Removes dirt, smudges and grime, leaving surfaces with a smooth, ultra-high gloss finish. Use in the sun or shade, and in hot or cool temperatures. 8.800 -0.15

..... **\$45.25 EA** ⚠





**Dressing & Conditioners, cont.**



**ADPG003 . . . . .ALL**  
 "V.R.T." RUBBER DRESSING, Adam's 1 gallon refill. Enhance & protect plastic, rubber, tires, moldings, dashboards and door panels. Applies easily with a sponge without a greasy film. Adds U.V. protection to keep vehicle interiors and exteriors looking and feeling like new. 8.800 -0.15  
**\$105.00 EA** ⚠

**303 Aerospace Protectant**

Keeps UV-sensitive materials "like new" year after year. Gives 100% prevention of UV caused slow-fade with regular use. No other protectant beautifies as intensely, protects as powerfully or lasts as long.



**030340 . . . . .ALL**  
 Used on Rubber, Vinyl, Gelcoat fiberglass, plastics, acrylics, polycarbonates, carbon-fiber resin composites & finished leather. 8.800 -0.15  
**\$16.00 EA** ⚠



**030370 . . . . .ALL**  
 "303" Aerospace Protectant, "SPF 40" for your auto, 1 gallon refill. 8.800 -0.15  
**\$73.00 EA** ⚠

**Clay Bar**



**ADPA001 . . . . .ALL**  
 "CLAY BAR", Adam's removes surface contamination without skid or swirl marks. The large 4-oz bar is suitable for 8-10 vehicles. 8.800 -0.15  
**\$12.25 EA** ⚠

**Wash Pad**



**ADPP010 . . . . .ALL**  
 Adam's 10" Car Wash Pad. Made of plush synthetic wool to ensure you are washing without introducing new swirls or scratches! -0.15  
**\$10.00 EA** ⚠

**Detail Sponge & Applicators**



**ADPA003 . . . . .ALL**  
 Large washable sponge applies a thin, even coat of Adam's Vinyl, Rubber, & Tire (V.R.T.) without the mess. 4 sponges. 8.800 -0.15  
**\$11.00 SET** ⚠



**ADPBRSWAB15 . . . . .ALL**  
 "Interior Detailing Swabs", Adam's 15 Pack 8.800 -0.15  
**\$12.75 SET** ⚠

**ADPBRSWAB6 . . . . .ALL**  
 "Interior Detailing Swabs", Adam's 6 Pack 8.800 -0.15  
**\$5.75 SET** ⚠



**ADPM001 . . . . .ALL**  
 Large washable sponge. Adam's 8.800 -0.15  
**\$11.50 SET** ⚠



**ADPTSPONGE . . . . .ALL**  
 Large washable detail sponge. Adam's 8.800 -0.15  
**\$2.75 SET** ⚠

**Towels**

**ADPM0010 . . . . .ALL**  
 Adam's microfiber glass cleaning towel. Pairs perfectly with Adam's glass cleaner to leave a streak free surface. (2 Pack) -0.15  
**\$7.75 EA** ⚠

**Towels, cont.**



**ADPM002 . . . . .ALL**  
 Adams Microfiber Polishing Towel is the softest, safest and most effective polishing towel on the market. Measuring 16" x 24", the thick yellow towel is ideal for removing polish and Detail Spray. We use two polishing towels for a standard detail. 8.800 -0.15  
**\$11.75 EA** ⚠



**ADPM008 . . . . .ALL**  
 Ultra-soft waffle starfiber jumbo microfiber drying towel. 25" x 36". Adam's 8.800 -0.15  
**\$23.50 EA** ⚠

**Water Blade**



**ALLWB1 . . . . .ALL**  
 Dry your car in 1/3 the time! The super soft medical grade silicone blade will never scratch your paint. The original California Water Blade. -0.15  
**\$12.00 EA** ⚠

**Polishing Ball**



**POWERBALL . . . . .ALL**  
 Mother's "PowerBall" Use with your favorite polishing compound/ liquid on a drill/ screw gun to revitalize metal, plastic and more. 6" dia. 8.800 -0.15  
**\$32.75 EA** ⚠



**POWERBALLM . . . . .ALL**  
 Mothers "PowerBall Mini" detail polishing ball with 10" extension for hard to reach areas. 3-1/4" dia. 8.800 -0.15  
**\$26.25 EA** ⚠



**WARNING:** Cancer and Reproductive Harm — www.P65Warnings.ca.gov

Chemicals shipped domestic ground only (Lower 48 states only). No international shipping.

Phone: (360) 816-0211 • (800) 999-CHEV (2438) • [www.chevsofthe40s.com](http://www.chevsofthe40s.com)

**Tire Care**



**91800 .....ALL**  
Wide White has been developed specifically to aid in restoring and beautifying wide whitewall tires. This cleaner is safe to use on white rubber and is made from

environmentally friendly ingredients. Restore your sidewalls to snowy white luster. -0

..... **\$11.00 EA** ⚠



**WHITEWIPE...ALL**  
Bleach free white wall tire wipes. 7" x 9" wipe. 35 per container. -0

..... **CALL** ⚠

**Duster**



**DUSTER .....ALL**  
California cotton duster w/ plastic handle. 8.800 -0.15

..... **\$15.95 EA** ⚠



**DUSTERW.....ALL**  
California cotton duster w/ wood handle. 8.800 -0.15

..... **\$21.75 EA** ⚠

**Truck Cover**

Recommended for inside use only.



**306800A .....ALL**  
Polycotton, 1/2T short bed. 16.550 -0.15

..... **\$302.25 EA** ⚠

**Truck Cover, cont.**

**306800T.....ALL**  
Polycotton, long bed. 16.550 -0.15

..... **\$280.00 EA** ⚠

**306803F .....ALL**  
Flannel, 1/2T short bed. 16.550 -0.15

..... **\$349.75 EA** ⚠

**306804F .....ALL**  
Flannel, long bed. 16.550 -0.15

..... **\$349.75 EA** ⚠

**Truck Cover Accessories**



**306800B.....ALL**  
Storage bag. 16.550 -0.15

..... **\$17.25 EA** ⚠



**306800L.....ALL**  
Lock set. 16.550 -0.15

..... **\$15.00 EA** ⚠

**Plastic Block**

Scaled engine. Plastic block w/ steel inserts allow you to bolt on actual parts such as valve covers, exhaust headers, front engine pieces, intake and more. Great for engine/ chassis setup, garage display, education, coffee table, etc. Add harmonic balancer to aid in checking front component clearances.



**PAP-2020 .....ALL**  
Chevy SB, long block w/heads. 0.000 -0.15

..... **\$524.00 EA** ⚠



**PAP-2021 .....ALL**  
Chevy SB, short block. 0.000 -0.15

..... **\$524.00 EA** ⚠

**Plastic Block, cont.**



**PAP-2041 .....ALL**  
Harmonic balancer for Chevy SB. Mount crank pulley for front end clearance. 0.000 -0.15

..... **\$56.00 EA** ⚠



**PAP-2120 .....ALL**  
Chevy BB, long block w/heads. 0.000 -0.15

..... **\$616.00 EA** ⚠



**PAP-2121 .....ALL**  
Chevy BB, short block. 0.000 -0.15

..... **\$431.00 EA** ⚠



**PAP-2125 .....ALL**  
Harmonic balancer for Chevy BB. Mount crank pulley for front end clearance. 0.000 -0.15

..... **\$56.00 EA** ⚠

**Auto Accessory**

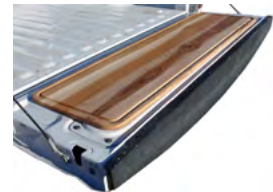

**BWTGFP5 .....ALL**  
Tailgate butcher block, 54" X 27" X 1". -0

..... **\$299.00 EA** ⚠



**SECTION 012T  
STREET ROD PARTS**

**Battery Jump Starter**



**GB40.....ALL**  
Compact, yet powerful 1,000 Amp lithium-ion jump starter that delivers 7,000 Joules of starting power. Its patented safety technology features spark-proof technology and reverse polarity protection making it safe for anyone to use. Designed for use with gas engines up to 6 liters and diesel engines up to 3 liters and doubles as a portable power source for recharging smartphones, tablets and more. -0.15  
..... **\$99.75 EA** ⚠️



**GB70.....ALL**  
The GB70 is a portable lithium-ion battery jump starter pack that delivers 2,000-amps (15,700 J3S) for jump starting a dead battery in seconds. It features a patented safety technology that provides spark-proof connections and reverse polarity protection making safe and easy for anyone to use. It's a powerful battery booster that doubles as a portable power source for recharging USB devices, like a smartphone, tablet and more, or powering 12-volt devices, like a tire inflator, power inverter and much more. And designed for a car, boat, RV, truck and more with gas engines up to 8 liters, and diesel engines up to 6 liters. -0.15  
... **\$199.75 EA** ⚠️

**Genius Battery Chargers**



**G1100.....ALL**  
1.1 Amp UltraSafe Smart Battery Charger

Charge fully drained lead-acid and lithium-ion batteries up to 40 amp-hour with zero overcharge - Stay safely connected 24/7.  
Ultimate performance and versatility. Charge 6-volt and 12-volt batteries, recover damaged batteries, suitable for micro-hybrid start-stop vehicles and works with CANBUS electrical systems.  
Ultra-compact, portable, energy-efficient design that's impact, UV and water-resistant (IP65).  
Actively monitors battery for safe and efficient charging. Includes spark-proof technology and reverse polarity protection.  
Advanced diagnostics automatically tests and detects a bad, damaged, or shorted battery. -0.15  
.. **\$39.75 EA** ⚠️



**G3500.....ALL**  
3.5 Amp UltraSafe Smart Battery Charger

Charge fully drained lead-acid and lithium-ion batteries up to 120 amp-hour with zero overcharge - Stay safely connected 24/7.  
Ultimate performance and versatility. Charge 6-volt and 12-volt batteries, recover damaged batteries, suitable for micro-hybrid start-stop vehicles and works with CANBUS electrical systems.  
Ultra-compact, portable, energy-efficient design that's impact, UV and water-resistant (IP65).  
Actively monitors battery for safe and efficient charging. Includes spark-proof technology and reverse polarity protection.  
Advanced diagnostics automatically tests and detects a bad, damaged, or shorted battery. -0.15  
.. **\$56.00 EA** ⚠️

**Oil Pad**

**OILPAD.....ALL**  
Absorbs oil, water, etc. Holds approx 1 gallon (3 ft x 3 ft). 8.821 -0.15  
..... **\$16.50 EA** ⚠️



**OILPAD1.....ALL**  
Absorbs oil, water, etc. Holds over 1 gallon. (3 ft x 5 ft). 8.821 -0.15  
.. **\$22.49 EA** ⚠️

**Gas Tank Restoration Kit**



**PORTANK.....ALL**  
Portank, Restore your tanks. Cleaner, metal prep, sealer (Slosh) and instructions. 3.001 -0.15  
.. **\$89.00 KIT** ⚠️

**Gas Tank Cleaner**

Works fast & makes petroleum-based cleaners nearly obsolete. Can be diluted with water up to 10 times its volume while remaining potent. Removes grease, oil, mildew, algae, musty odors, soap films & wax. Use it to clean canvas, vinyl, nylon, holding tanks, grease traps, auto parts and more.



**PORCLEAN....ALL**  
1 quart.  
MARINE-CLEAN cleans and degreases in one application without leaving residues, noxious fumes or flammable solvents. It makes petroleum-based cleaners almost obsolete because it can be diluted with water up to 3, 4, 5 and even 10 times its volume while remaining more potent than other cleaners. 3.001 -0.15  
..... **\$13.25 EA** ⚠️

# Section 012T: Tools, Adhesives, Brake Fluid, Gas Tank Prep & Sealer, Carburetor & Brake Cleaners and Polishers

## Metal Prep

Provides adhesion for POR-15 paint (Sect. 15) on aluminum and shiny polished metal surfaces. Etches metal and leaves a zinc phosphate coating. Non-caustic, non-corrosive, non-toxic & non-flammable.



**PORMETAL . . . . .ALL**  
Etches Metal and Leaves a Zinc Phosphate Coating. Provides the best adhesion for POR-15 on any metal surface.

Water based,

OSHA approved biodegradable solution.

3.001 -0.15

..... **\$16.99 QT** ⚠️

## Fuel Stabilizer

Keep fuel fresh. Removes water, cleans carburetors & fuel injectors. Protects engine from gum, varnish, rust, and corrosion. Eliminates need to drain fuel before storage. Special dispenser bottles measure exactly without waste. Contains NO alcohol.



**111801 . . . . .ALL**  
STA-BIL stabilizer. 8 oz bottle treats 20 gallons, for one year. 3.001 -0

..... **\$8.25 EA** ⚠️



**111801B . . . . .ALL**  
STA-BIL fuel stabilizer. 32 oz bottle treats 80 gallons, for one year. 3.001 -0.15

..... **\$21.00 EA** ⚠️

## Rust Remover



**1001PL . . . . .ALL**  
Rust Remover. Works great, is biodegradable and non-caustic. Our shop loves this product. Great for cleaning inside gas tanks. Sold as a concentrate that

makes 3 gallons. 8.800 -0.15

..... **\$30.00 EA** ⚠️

## Rust Preventer, cont.



**RPM8 . . . . .ALL**  
This is liquid Rust Preventative Magic in an 8 ounce tub. The new wax-like product is easy to apply and will protect bare metal from rusting. It will not reverse rust or remove it, so you will need to sandblast or glass bead any rusty parts clean first. -0.15

..... **\$35.09 EA** ⚠️

## Brake Cleaner



**6129423 . . . . .ALL**  
Superior cleaner. Many uses (spray can). APPLICATIONS: ABS, disc, drum, brake cylinders, brake drums, brake linings, brake shoes, calipers, clutch discs, disc brake

pads, discs. Safe for use on all brake systems including: Springs & Wedge brakes.

4.683 -0.2

..... **\$4.00 EA** ⚠️

## Brake Fluid



**5450285B . . . . .ALL**  
Master "Fade Free" DOT 4 (12 oz). 4.683 -0.15

..... **\$7.00 EA** ⚠️



**603486B . . . . .ALL**  
Mac's, DOT 5, silicone. Less corrosion. 12 ounce bottle. 4.683 -0.15

..... **\$10.25 EA** ⚠️

## Adhesives & Sealers



**01608 . . . . .ALL**  
3M plastic & emblem adhesive (5 oz. tube).

8.800 -0.15

..... **\$9.75 EA** ⚠️



**1015BP . . . . .ALL**  
Gasket sealer, high temp silicone. Black (3.35 oz tube).

8.800 -0.15

..... **\$10.00 EA** ⚠️



**306105 . . . . .ALL**  
Super Glue Gel. Bonds to ABS, Ceramic, cork, G10 Epoxy Glass, Leather and paper. Splice window gaskets & sponge weather strip & more. 8.800 -0.15

..... **\$3.50 EA** ⚠️



**306106 . . . . .ALL**  
LOCTITE Super Glue, Ultra Gel Control. Bonds to Metal, Rubber, Ceramics, Wood, Leather, Paper & Plastics. Rubber to metal & rubber to rubber bonding. Splice

window gaskets & sponge weather strip & more. 8.800 -0.15

..... **\$5.25 EA** ⚠️



**511113 . . . . .ALL**  
Quality Spray adhesive for bowdrill cloth. Best product available for all interior trim. (14 oz. spray can). 8.800 -0.2

..... **\$22.00 EA** ⚠️



**511114 . . . . .ALL**  
3M, Black weatherstrip cement, 5-oz tube. Superior product!. 8.800 -0.2

..... **\$20.00 EA** ⚠️

Returns require a return authorization number—call first. • Product pricing & availability subject to change.



**WARNING:** Cancer and Reproductive Harm — [www.P65Warnings.ca.gov](http://www.P65Warnings.ca.gov)

**Adhesives & Sealers, cont.**



**986199A . . . . .ALL**  
3M Contact cement for rubber to metal. Bonds instantly. Industrial quality for gravel guards, running board rubber, etc. 8.800 -0.15  
..... **\$64.75 QT** ⚠

**GL14 . . . . . ALL**  
Windshield sealer. Seals leaks in new & old installation. Will not dry out rubber. Remains pliable. 8.991 -0.15  
..... **\$7.25 EA** ⚠

**Adhesive Remover**



**3M8987 . . . . .ALL**  
Specially blended solvent for removal of light paint overspray, adhesive residue, wax, grease, tree sap, dirt, road tar, oil and bugs in aerosol form. -0.15  
..... **\$19.75 EA** ⚠

**Safety Wire Pliers**



**R809 . . . . .ALL**  
Safety Wire Pliers - 9". -0.15  
..... **\$39.75 EA** ⚠

**Gas Tank Sealer**



**3657942C . . . . .ALL**  
Gas tank sealer slosh, seals gas tank. Alcohol and Ethanol proof. Not for use with (MEK) Methyl Ethyl Ketone. 3.001 -0.15  
..... **\$32.25 QT** ⚠

**SECTION 012T RESTORATION PARTS**

**Tools**

**16460T . . . . .ALL**  
Crimping tool for the wiring. -0  
..... **CALL** ⚠



**4088134A . . . . .ALL**  
Installs door handle ferrules. Return tool in same condition as sent for a \$20 refund. Does not fit with 4125630 10.537 -0.15  
..... **\$46.00 EA** ⚠

**Lubricator & Bolt Loosener**



**511115 . . . . .ALL**  
Graphite lubricant for your speedometer cable, .5 oz tube. -0.15  
..... **\$2.75 EA** ⚠



**PBBLASTER . . . . .ALL**  
Powerful rust inhibitor, bolt loosener/penetrant. -0.15  
..... **\$12.25 EA** ⚠

**Clutch Head Socket Set**



**CHSS-4 . . . . .ALL**  
4 pc. 3/8 Drive. Includes 5/16", 1/4", 3/16", 5/32" sockets. 8.821 -0.15  
..... **\$20.50 SET** ⚠

**Clutch Head Driver W/ Bits**



**DRIVER . . . . .ALL**  
Magnetic clutch head driver, Chev's imprint. w/ 5 bits (1/8 in., 5/32 in., 3/16 in., 1/4 in., 5/16 in.) 8.821 -0  
..... **\$22.25 SET** ⚠

**Clutch Head Bits**



**3685592 . . . . .ALL**  
Clutch head bit 5/32 in. (1/4 in. drive) 8.821 -0.4  
..... **\$5.00 EA** ⚠



**3685593 . . . . .ALL**  
Clutch head bit 1/4 (1/4 in. drive) 8.821 -0.4  
..... **\$4.75 EA** ⚠



**3685594 . . . . .ALL**  
Clutch head bit 3/16 in. (1/4 in. drive) 8.821 -0.3  
..... **\$2.75 EA** ⚠



**3685595 . . . . .ALL**  
Clutch head bit 5/16 in. (1/4 in. drive) 8.821 -0.2  
..... **\$8.50 EA** ⚠



**3685598 . . . . .ALL**  
Clutch head bit 1/8 in. (1/4 in. drive) 8.821 -0.15  
..... **\$2.50 EA** ⚠

**Clutch Bit Holder**



**3685596 . . . . .ALL**  
Clutch bit holder for your 1/4 in. drive ratchet. Holds clutch head bits. 8.821 -0.2  
..... **\$7.00 EA** ⚠

**Tool Bag**



**986362 . . . . .ALL**  
Tool bag. Superb reproduction w/ pictures of tools which may be found at swap meets. 13-5/8" x 6". 8.821 -0.15  
..... **\$22.00 EA** ⚠

**Engine, Drivetrain Tools**



**38352226 . . . . .37-53**  
Tool used to align oil dipper troughs in pan (\$375 refundable deposit upon return of tool) 1.427 -0.15  
..... **starting at \$477.00 Rent** ⚠

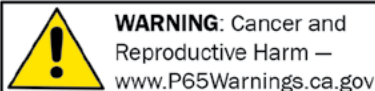

**WARNING: Cancer and Reproductive Harm** — www.P65Warnings.ca.gov

Chemicals shipped domestic ground only (Lower 48 states only). No international shipping.

Phone: (360) 816-0211 • (800) 999-CHEV (2438) • [www.chevsofthe40s.com](http://www.chevsofthe40s.com)

**Section 012T: Tools, Adhesives, Brake Fluid, Gas Tank Prep & Sealer, Carburetor & Brake Cleaners and Polishers**

**Engine, Drivetrain Tools, cont.**



**595005A** .....**37-54**  
 Drive shaft bushing puller to rent (return in original condition for \$20.00 refund).  
 5.451 -0.15 ..... **\$75.00 EA** ⚠



**838956A** .....**ALL**  
 Tool to align clutch disc. 0.866 -0.3 .....  
**\$7.00 EA** ⚠

**Body Tools**



**3847415T** .....**42-54**  
 Inserts back glass rubber lock strip.  
 16.469 -0.15 ..... **\$54.00 EA** ⚠



**010351** .....**ALL**  
 Removes mouldings (Amazing!) 8.821 -0.15  
 ..... **\$22.25 EA** ⚠



**01832** .....**ALL**  
 To install windshield & back window rubber (exc 41-48 w/ mouldings) 8.821 -0.15  
 ..... **\$17.00 EA** ⚠



**WELDCLAMP** .....**ALL**  
 Clamps two pieces of metal together for welding. -0.15 ..... **\$23.50 SET** ⚠

**Interior Tools**



**4173376A** .....**49-65**  
 Sets vent window pivot pin. 10.669 -0.15  
**\$5.00 EA** ⚠

**ALLHRDR** .....**ALL**  
 1-1/4" wide with black painted hardwood handle, roller tool for applying sound deadening. -0.15  
 ..... **\$12.95 EA** ⚠

**Stainless Steel Tubing**



**SSTUBING** .....**ALL**  
 304 seamless tubing in 1/2", 5/8" & 3/4" O.D. Can be cut to length. Total lengths up to 20 ft sticks (oversize shipping on long lengths). -0

..... starting at **\$10.00 FT** ⚠

**Battery Terminal Cleaner**



**10653CLNR** ...**ALL**  
 For Top Post Batteries. -0.15  
 ..... **\$9.25 EA** ⚠

**Carburetor Cleaner**



**6505259** .....**ALL**  
 Gumout, 16 oz spray can. Cleans carburetors, linkage, choke valves and unpainted metal parts. 3.725 -0.15

..... **\$7.75 EA** ⚠

Returns require a return authorization number—call first. • Product pricing & availability subject to change.



**WARNING:** Cancer and Reproductive Harm — [www.P65Warnings.ca.gov](http://www.P65Warnings.ca.gov)

**SECTION 015T  
STREET ROD PARTS**

**POR-15 Rust Preventative Paint**



**POR-15QT.....ALL**  
1 quart. POR-15 Rust-preventative coating applied directly over rusted or seasoned metal surfaces. Dries as rock hard, nonporous finish that won't chip, crack or peel. Prevents rust from reoccurring. Choose Black, Semi-Gloss Black, Grey, Silver or Clear. 8.800 -0.15 **\$48.50 QT** ⚠️

**Sound Deadener-Thermal Protection**



8.800 -0.15

**DEADENER ....ALL**  
Engineered for the interior & exterior side of body panels. 200% decrease in noise & vibration. Bonds to metal, fiberglass & wood. Covers 30 sq. ft.

**\$85.00 GALLON** ⚠️



**SPRAYGUN.....ALL**  
Spray gun. Siphon-feed spray gun for DEADENER.

8.800 -0.15

**\$89.25 EA** ⚠️



**VB-1SPRO ....ALL**  
For exterior automotive panels such as inside fender wells, wheel arches and underside of the floor pan. Converts structural resonance

and vibration into low level heat through friction. It remains soft which allows it to absorb the impact of road debris. (NOTE: Only apply to exterior surfaces due to prolonged outgassing). 18 oz. aerosol can. Covers 4 sq. ft. 8.800 -0.15

**\$14.50 EA** ⚠️

**Zero Rust Paint**



**511112C.....ALL**  
Satin black w/ rust inhibitors. Use on core supports, inner fender panels, etc. (12 oz. spray). Match to GM satin black. 8.800 -0.15  
**\$20.50 EA** ⚠️

**POR-15 Rust Paint Solvent**



**POR-15QTSLV . .ALL**  
Thinner. Use for easy cleanup or thinning of POR-15 paint. 8.800 -0.15  
**\$15.75 QT** ⚠️

**VHT Hi-Temp Engine Enamel**



**986959B.....ALL**  
VHT Hi-Temp Gloss Black Engine enamel (11 oz. spray can). 8.800 -0.15  
**\$10.75 EA** ⚠️



**986959FB....ALL**  
VHT Hi-Temp Flat Black Engine enamel (11 oz. spray can). 8.800 -0.15  
**\$11.50 EA** ⚠️



**986959O.....ALL**  
VHT Hi-Temp Chevy Orange enamel (12 oz. spray can). 8.800 -0.15  
**\$12.75 EA** ⚠️



**986959R.....ALL**  
VHT Hi-Temp Universal Red Engine enamel (11 oz. spray can). 8.800 -0.15  
**\$14.00 EA** ⚠️

**VHT Hi-Temp Engine Enamel, cont.**



**986959SB.....ALL**  
VHT Hi-Temp Chevy GM Satin Black Engine enamel (11 oz. spray can). 8.800 -0.15  
**\$12.00 EA** ⚠️



**986959UA....ALL**  
VHT Hi-Temp Universal Aluminum Engine enamel (11 oz. spray can). 8.800 -0.15  
**\$10.49 EA** ⚠️

**Exhaust Paint**



**3657963C.....ALL**  
Exhaust paint stainless steel pigments. For exhaust manifolds & pipes. Gives a soft grey, metallic finish. Pint 3.609 -0  
**CALL** ⚠️



**3657963E....ALL**  
Exhaust paint clear, high temp (1200 degree) for exhaust etc, 11 oz spray can. 3.609 -0.15  
**\$15.00 EA** ⚠️



**3657963FA....ALL**  
Exhaust paint very high temp, flat aluminum for manifolds & pipes. 11 oz spray can. 3.609 -0.15  
**\$15.00 EA** ⚠️



**WARNING:** Cancer and Reproductive Harm — [www.P65Warnings.ca.gov](http://www.P65Warnings.ca.gov)

Chemicals shipped domestic ground only (Lower 48 states only). No international shipping.

**Phone: (360) 816-0211 • (800) 999-CHEV (2438) • [www.chevsofthe40s.com](http://www.chevsofthe40s.com)**

**Cast Blast Paint**



**3657963D . . . . .ALL**  
Cast blast paint high temp 1200 degree. Grey, fresh cast look for exhaust manifolds, etc. Rust preventative, 11 oz spray can. 3.609 -0.15

. . . . . **\$12.75 EA** ⚠



**3657963F . . . . .ALL**  
Grey cast color paint, For non high heat applications. Gives fresh cast look. Rust preventative, 11 oz spray can. 3.609 -0.15

. . . . . **\$6.75 EA** ⚠

**Inner Fender Panel Paint**



**511112D . . . . .ALL**  
Semi-flat black spray paint for use on core supports and inner fender panels. 8.800 -0.15

. . . . . **\$11.00 EA** ⚠

**SECTION 015T RESTORATION PARTS**

**Clear Coat Paint**



**10200Z . . . . .ALL**  
Gloss Clear Coat For Bare Metal Surfaces. Great for use on polished metal to keep the shine. 8.800 -0.15

. . . . . **\$17.25 EA** ⚠

**Engine Paint**



**986959A . . . . .29-52**  
Engine Grey. Reduce using Xylene (max of 15%). 8.800 -0.15

. . . . . **\$40.00 QT** ⚠

**Engine Paint, cont.**



**986959S . . . . .29-52**  
Chevy Engine Grey hi-temp (16 oz. spray can). Color has been tested and is correct. 8.800 -0.15

. . . . . **\$25.25 EA** ⚠



**986970G . . . . .37-46**  
Engine (olive) GMC 8.800 -0.15

. . . . . **\$56.75 QT** ⚠



**986970M . . . . .47-59**  
Engine (red orange) GMC 8.800 -0.15

. . . . . **\$63.75 QT** ⚠



**986970A . . . . .53-62**  
Engine Blue 8.800 -0.15

. . . . . **\$56.75 QT** ⚠



**986970S . . . . .53-62**  
Chevy Engine Blue (12-3/4 oz. spray can). 8.800 -0.15

. . . . . **\$25.00 EA** ⚠

**Carburetor Paint**



**12910 . . . . .ALL**  
Carburetor renew, bronze (5 oz. spray can). Fuel and additive resistant 8.800 -0

. . . . . **\$19.00 EA** ⚠

**Carburetor Paint, cont.**



**12911 . . . . .ALL**  
Carburetor renew, silver (5 oz. spray can) 8.800 -0.15

. . . . . **\$21.25 EA** ⚠

**Cab Interior Paint**



**604481P . . . . .40-46**  
Beige hammertone for cab interior (thin w/ enamel thinner) 16.080 -0

. . . . . **CALL** ⚠



**3693291P . . . . .47-53**  
Semi flat brown, slight metallic for cab interior. Acrylic enamel (thin w/ enamel thinner). 16.080 -0.15

. . . . . **\$40.00 QT** ⚠



**3700359P . . . . .47-54**  
Pulsar grey, for cab interior, 47-54 Panel & Suburban 54 deluxe cab, interior enamel 16.080 -0.15

. . . . . **\$57.50 QT** ⚠



**985734S . . . . . 54**  
Pearl beige for interior of cab. 16.080 -0.15

. . . . . **\$57.50 QT** ⚠

**Battery Tray Paint**



**12998 . . . . .ALL**  
Battery tray Corrosion resistant, black (12 oz spray). 8.800 -0.15

. . . . . **\$10.25 EA** ⚠





**Heater Paint**



**604481P . . . .42-46**  
 Heater beige  
 hammertone (thin  
 w/ enamel thinner).  
 16.080 -0  
 . . . . . **CALL** ⚠️

**Inner Fender Panel Paint**



**511112 . . . . .ALL**  
 Zero Rust Inner  
 fender panel satin  
 black-also great  
 for core supports.  
 (quart) 8.800 -0.15  
 . . . . . **\$40.00 QT** ⚠️

**Hub Caps & Trim Paint**



**306505 . . . . .ALL**  
 Black, for hub caps  
 & trim (special  
 lettering enamel)  
 1/2 pint 8.800 -0.15  
 . . . . . **\$27.50 EA** ⚠️



**306553 . . . . .ALL**  
 Blue, for hub caps  
 & trim (special  
 lettering enamel).  
 1/2 pint. 8.800 -0.15  
 . . . . . **\$30.75 EA** ⚠️



**306567 . . . . .ALL**  
 Red, for hub caps  
 & trim (special  
 lettering enamel)  
 1/2 pint 8.800 -0.15  
 . . . . . **\$37.25 EA** ⚠️



**1937 Half-ton — David Faller**

 **WARNING:** Cancer and  
 Reproductive Harm —  
[www.P65Warnings.ca.gov](http://www.P65Warnings.ca.gov)

## Engine Cylinder Head and Manifolds

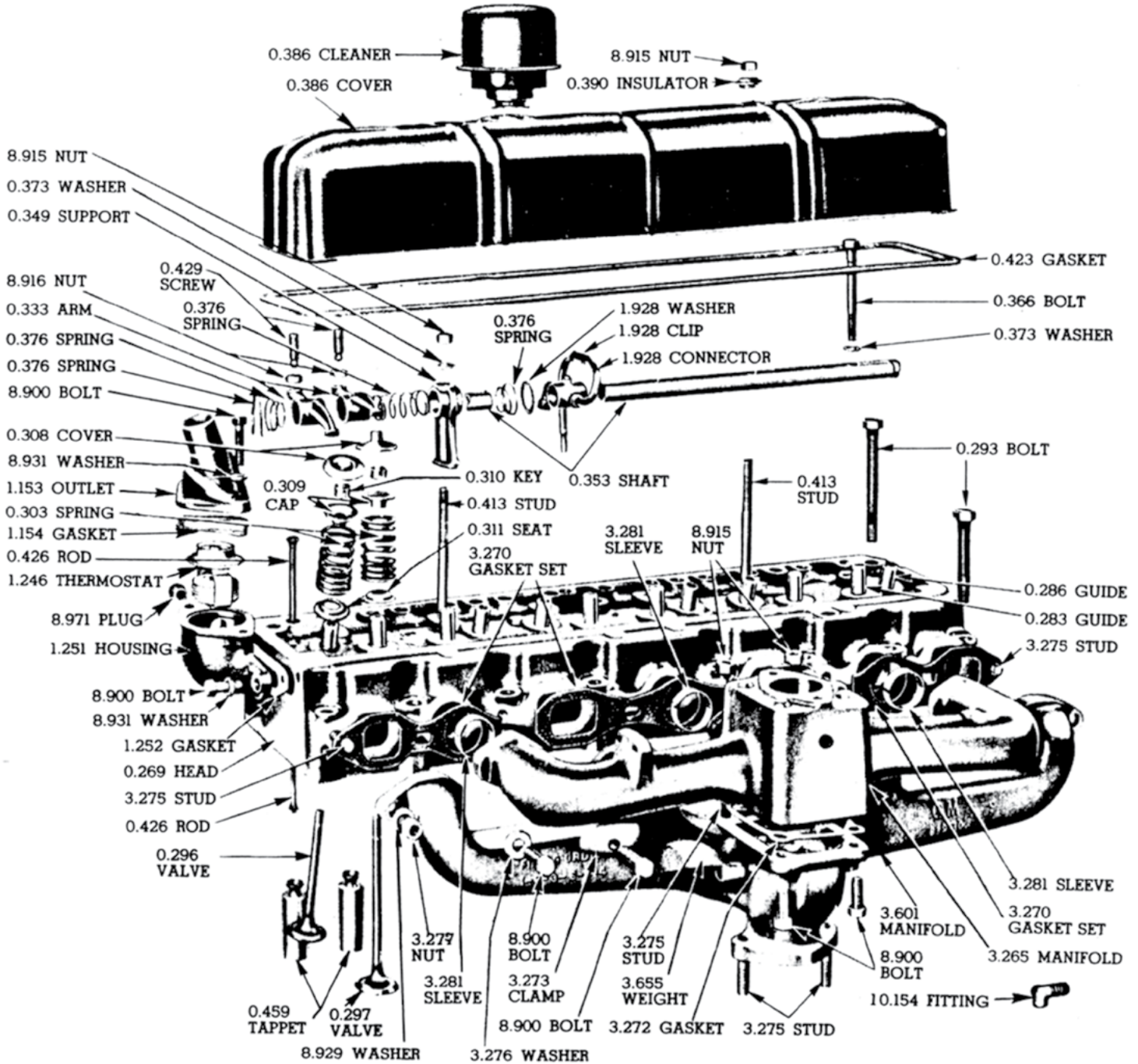

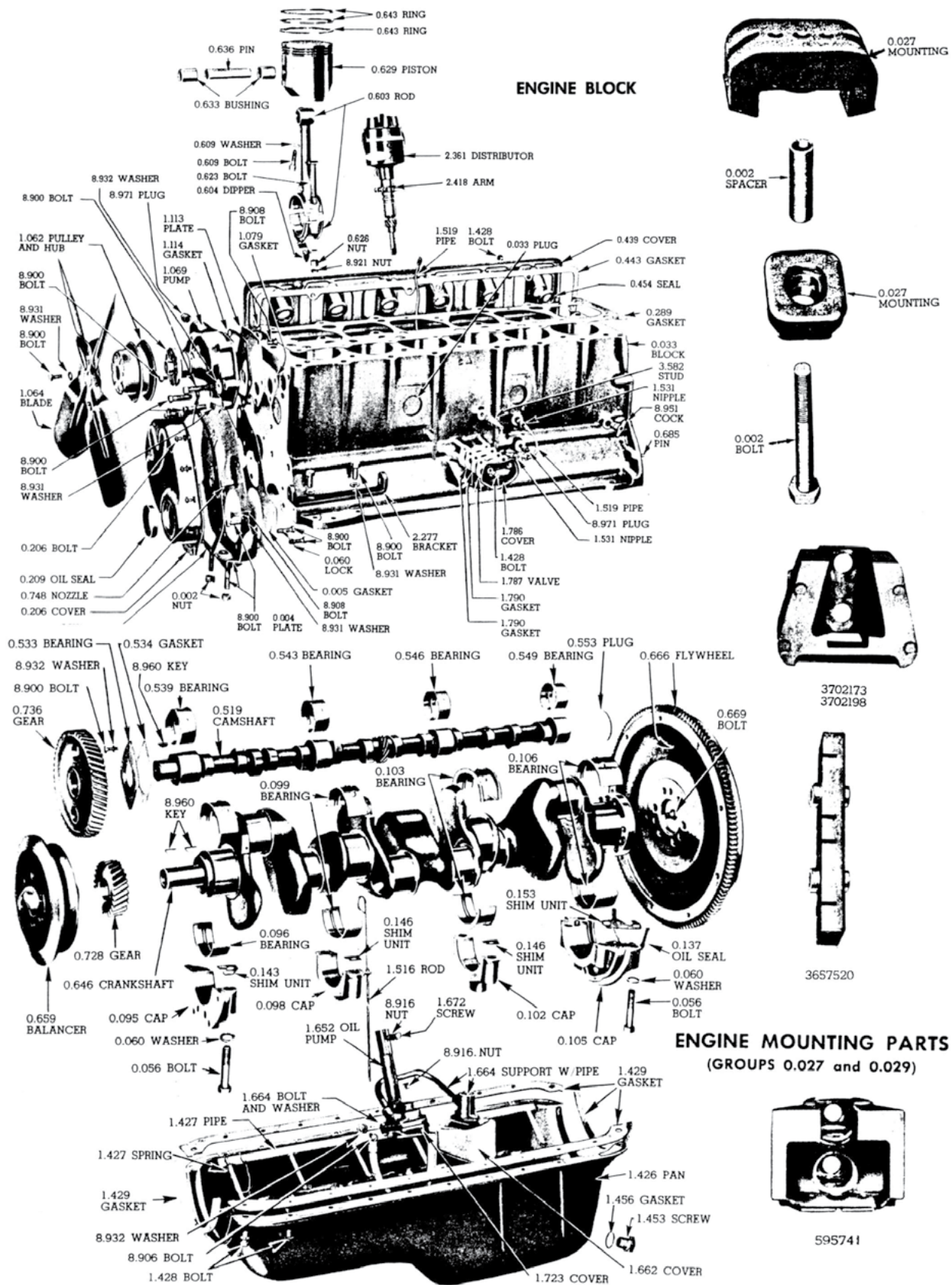

**WARNING:** Cancer and Reproductive Harm — [www.P65Warnings.ca.gov](http://www.P65Warnings.ca.gov)

Chemicals shipped domestic ground only (Lower 48 states only). No international shipping.  
**Phone: (360) 816-0211 • (800) 999-CHEV (2438) • [www.chevsofthe40s.com](http://www.chevsofthe40s.com)**

# Section 020T: Engine Kits

## Engine ID Chart

Model Year	216 CU Inch Numbers	Block Numbers
1937	1 – 1187821	838101 838710
1938	1187822 – 1915446 B1 – B10502	838710
1939	1915447 – 2697267 B10503 – B105461	838941
1940	2697268 – 3665902 B105462 – B221935	839400
1941	AA 1001 – AA AC 1001 – AC 19549	1163720 839400
1942	2AA, 2AC, BA	839770
1946	DA	839770
1947	EA	839770
1948	FA	3835253
1949	GA	3835253
1950	AHCA, AHCM, BHCA, BHCM, HAA, HAM, HAC, HAP, HBA, HBM, HCA, HCM, HCD, HCQ	3835497
1951	AJCA, AJCM, BJCA, BJCM, JAA, JAM, JAC, JAP, JBA, JBM, JCA, JCM, JCD, JCQ	3835497
1952	AKCA, AKCM, BKCA, CKCM, KAA, KAM, KAC, KAP, KBA, KBM, KCA, KCM, KCD, KCQ	3835849
1953	ALCC, ALCP, BLCC, BLCP, LAG, LAT, LAJ, LAV, LBA, LAM, LCA, LCM, LCC, LCP, LCD, LCH, LCU	3835849

Model Year	235 CU Inch Prefixes	Block Numbers
1941	AG, AL	3660439
1942	BG, BL	839751
1946	BG, BL—1st design	839751
1946	DDA, DDM, DEA, DEM—2nd design	839751
1947	EDA, EDM, EEA, EEM	3835335
1948	FDA, FDM, FEA, FEM	3835309
1949	GDA, GDM, GEA, GEM	3835309
1950	HDA, HDM, HEA, HEM	3692703
1951	JDA, JDM, JEA, JEM	3692703
1952	KDA, KDM, KEA, KEM	3835692

Model Year	235 CU Inch Prefixes	Block Numbers
1953	LDA, LDM, LEA, LEM, LAA	3701946 3701483
1954	T54 or F54 followed by: L, LA, M, MA, MB, N, P, Q, R, S, T, TA, U, UA, UB, X, XZ, XB, Y, YE, YG, Z, ZC, ZE, ZH	3701481
1954	Except 53 ST	3701481
1954	First series	3733949
1955	Through 4/1/56	3836233

Model Year	261 CU Inch Engine Block	Block Numbers
1954–55	First series	3702436 3703414
1956	All	3836340
1957	All	3836340
1955–57	All	3836340
1958	All	3836340
1959	All	3759365
1960–62	All	3769923

**Note: The 235 cu. in. engine can be distinguished from the 216 engine by the engine serial number prefix as follows:**

1941	AG or AL
1942	BG or BL
1946	BG or BL (First Design)
1946	DDA, DDM, DEA, or DEM (Second Design)
1947	EDA, EDM, EEA, or EEM
1948	FDA, FDM, FEA, or FEM
1949	GDA, GDM, GEA, or GEM
1950	HDA, HDM, HEA, or HEM
1951	JDA, JDM, JEA, or JEM
1952	KDA, KDM, KEA, or KEM
1953	LDA, LDM, LEA, or LEM



**SECTION 020T  
RESTORATION PARTS**

Oversize shipping charges apply. Please call for rate.

**Engine Kit**

When ordering: SPECIFY exact year and size of engine (216ci, 235ci or 261ci), HYDRAULIC or solid lifters, standard or exact oversize of rod, main bearings, pistons and rings. Also SPECIFY stick shift or powerglide.

Call for availability of pistons & bearings before boring block or having crank turned.

**MEK1 Engine Kit**

MEK1 contains all parts necessary to overhaul a complete short block assembly. Including: Rods machined for insert bearings, rod bearings, main bearings, pistons with pins, piston rings, new camshaft, lifters, cam bearings, timing gears, full gasket set, soft plugs, plastigauge, oil pump, bolt boots & block sealant lube (1937-39 includes pushrods). \*Assembly lube no longer included.

**MEK139** ..... **37-39**  
216. Includes pushrods, does not include oil pump 0.001 -0.15  
..... **\$1,600.00 KIT** ⚠

**MEK140** ..... **40**  
216 0.001 -0.15  
..... **\$1,845.00 KIT** ⚠

**MEK147** ..... **41-47**  
216 0.001 -0.15  
..... **\$1,845.00 KIT** ⚠

**MEK153** ..... **48-53**  
216 0.001 -0.15  
..... **\$1,475.00 KIT** ⚠

**MEK162** ..... **53-62**  
235. Except 53 stick 0.001 -0.15  
..... **\$1,300.00 KIT** ⚠

**EK Engine Kit**

EK contents are same as MEK1 except w/ out pistons/rings & converted rods.

**EK39** ..... **37-39**  
Includes pushrods 0.001 -0.15  
..... **\$750.00 KIT** ⚠

**EK Engine Kit, cont.**

**EK47** ..... **40-47**  
This is an engine kit. (EK)

The kit contains:  
Rod bearings (specify size)  
Cam bearings  
camshaft  
Lifters  
Timing gears  
Full gasket set  
Soft plug set  
Plastigauge (used to measure bearing tolerances)  
Bolt boots (go on rod bolts to protect crank)

0.001 -0.15  
..... **\$825.00 KIT** ⚠

**EK53** ..... **48-53**  
Except 53 Powerglide 0.001 -0.15  
..... **\$895.00 KIT** ⚠

**EK62** ..... **53-62**  
Except 53 stick 0.001 -0.15  
..... **\$675.00 KIT** ⚠

**EK58** ..... **54-58**  
For solid lifter 261ci 0.001 -0.15  
..... **\$715.00 KIT** ⚠

**RRK Re-Ring Kit**

RRK contains: Rod bearings, piston rings, full gasket set, plastigauge, assembly lube & bolt boots.

**RRK39** ..... **37-39**  
This is an piston re-ring kit (RRK) that includes:

Full gasket set  
Rod bearings (choose size, std. to .060)  
Piston rings (choose size)  
Bolt boots for rod installation (protect crank)  
Plastiguage (for measuring bearing tolerances)  
Assembly Lube 0.001 -0.2  
..... **\$625.00 KIT** ⚠

**RRK53** ..... **40-53**  
Except 53 Powerglide 0.001 -0.4  
..... **\$625.00 KIT** ⚠

**RRK62** ..... **53-62**  
Except 53 stick 0.001 -0.3  
..... **\$625.00 KIT** ⚠

**RRK3 (Re-Ring Kit w/ Main Bearings)**

RRK3 contents are same as RRK except main bearings are included.

**RRK339** ..... **37-39**  
This is an RRK3 piston re-ring kit that includes:

Full gasket set  
Rod bearings (choose size)  
Main bearings (choose size)  
Piston rings (choose size)  
Bolt boots for rod installation (protect crank)  
Plastiguage (for measuring bearing tolerances)  
Assembly Lube

0.001 -0.4  
..... **\$625.00 KIT** ⚠

**RRK347** ..... **40-47**  
This is an RRK3 piston re-ring kit that includes:

Full gasket set  
Rod bearings (choose size)  
Main bearings (choose size)  
Piston rings (choose size)  
Bolt boots for rod installation (protect crank)  
Plastiguage (for measuring bearing tolerances)  
Assembly Lube

0.001 -0.4  
..... **\$625.00 KIT** ⚠

**RRK353** ..... **48-53**  
Except 53 Powerglide 0.001 -0.4  
..... **\$625.00 KIT** ⚠

**RRK362** ..... **53-62**  
Except 53 stick 0.001 -0.4  
..... **\$625.00 KIT** ⚠

**CLK (Cam & Lifter Kit)**

CLK contains: Reground camshaft, lifters & timing cover gasket set.

**CLK39** ..... **37-39**  
Solid lifter w/ pushrods 0.001 -0.3  
..... **\$525.00 KIT** ⚠

**CLK53** ..... **40-53**  
Solid lifter exc 53 Powerglide 0.001 -0.15  
..... **\$315.00 KIT** ⚠

**CLK62** ..... **53-62**  
Hydraulic lifter exc 53 stick 0.001 -0.15  
..... **\$360.00 KIT** ⚠

**CLK58** ..... **54-58**  
Solid lifter. 0.001 -0.15  
..... **\$300.00 KIT** ⚠



**WARNING:** Cancer and Reproductive Harm — www.P65Warnings.ca.gov

Chemicals shipped domestic ground only (Lower 48 states only). No international shipping.

**Phone: (360) 816-0211 • (800) 999-CHEV (2438) • www.chevsofthe40s.com**

## Section 020T: Engine Kits

### CLK3 (Cam, Lifter Kit & Timing Gears)

CLK3 contents are the same as CLK except timing gears are included.

**CLK339.....37-39**

Solid lifter w/ pushrods 0.001 -0.15

..... **\$425.00 KIT** ⚠

**CLK353.....40-53**

Solid lifter exc 53 Powerglide 0.001 -0.15

..... **\$450.00 KIT** ⚠

**CLK362.....53-62**

Hydraulic lifter exc 53 stick 0.001 -0.15

..... **\$350.00 KIT** ⚠

**CLK358.....54-58**

Solid lifter. 0.001 -0.15

..... **\$375.00 KIT** ⚠

### PRK (Piston & Ring Kit)

PRK contains: Pistons with pins and piston rings.

**PRK40 .....37-40**

Domed piston 0.001 -0.15

..... **\$341.00 KIT** ⚠

**PRK53 .....41-53**

216ci 0.001 -0.15

..... **\$312.00 KIT** ⚠

**PRK62 .....41-62**

235ci (exc 53 Powerglide) 0.001 -0.15

..... **\$288.00 KIT** ⚠

**PRK61.....54-62**

261ci 0.001 -0

..... **\$353.00 KIT** ⚠



**SECTION 022T  
RESTORATION PARTS**

Note: Pilot bearing bushing see Section 140T.

Note: Engine electrical see Section 40T, 45T & 50T.

Note: Fuel pump & carburetor see Section 120T.

Note: Pilot bearing bushing see Section 140T.

**Valve & Rocker Cover Set**



**3836614S** .....50-62  
235ci chromed side cover & valve cover w/ breather cap and gaskets. Excellent finish. 0.386 -0 ..... **\$116.00 SET** ⚠

**Valve Cover**



**3686784C** .....37-53  
Chrome 1937-53 Chevy 216 6-cyl Valve Cover - Unbaffled. -0.15 ..... **\$60.50 EA** ⚠



**R9107** .....50-62  
Chrome 1950-62 Chevy 235 6-cyl Valve Cover - Unbaffled. -0.15 ..... **\$60.25 EA** ⚠

**Finned Valve Cover**



**3686784F** .....37-62  
Finned aluminum valve cover for 216 & 235. -0 ..... **\$279.75 EA** ⚠

**Finned Valve Cover, cont.**



**3686784FP** .....37-62  
Finned polished aluminum valve cover for 216 & 235. -0 ..... **\$389.75 EA** ⚠

**Offenhauser Valve Cover**



**38366140** .....37-62  
Offenhauser Ribbed for 235ci. Polished aluminum valve cover. 0.386 -0.15 ..... **\$370.75 EA** ⚠

**Wayne Valve Cover**



**3686784W** .....37-62  
"Wayne" Finned aluminum cover. Superb reproduction w/ breather cap and stud kit. 0.386 -0 ..... **CALL** ⚠

**Side Covers Chevy Six Cylinder**



**3701541F** .....50-62  
Finned plain aluminum side cover. Fits 235ci-261ci. 0.439 -0 .. **\$219.50 EA** ⚠



**3701541FP** .....50-62  
Finned polished aluminum side cover. Fits 235ci-261ci. 0.439 -0 .. **\$299.75 EA** ⚠

**37015410F** .....50-62  
Offenhauser Finned polished aluminum side cover. Fits 235ci-261ci. -0 ..... **\$306.00 EA** ⚠

**Side Covers Chevy Six Cylinder, cont.**

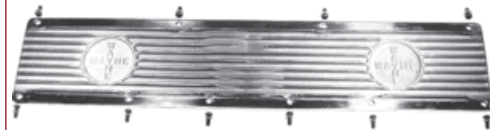

**3701541W** .....50-62  
"Wayne" Finned aluminum side cover. Superb reproduction, fits 235ci-261ci. 0.439 -0 ..... **CALL** ⚠



**R9108** .....ALL  
Chrome 1950-62 Chevy 235 6-cyl Side Plate. -0.15 ..... **\$44.50 EA** ⚠

**Valve Cover Grommets**



**838083** .....34-53  
2 pcs 0.413 -0.15 ..... **\$5.00 PR** ⚠

**Valve Cover Acorn Nut**



**131502** .....29-53  
Stainless 8.915 -0.3 ..... **\$6.50 PR** ⚠



**131502C** .....29-53  
Chrome 8.915 -0.15 ..... **\$5.50 PR** ⚠



**131502P** .....29-53  
Polished stainless 8.915 -0.15 ..... **\$13.00 PR** ⚠

**Valve Cover Hardware Aftermarket**



**838083B** .....37-62  
Studs, washers & nuts for Wayne or Offy valve cover 0.413 -0.15 ..... **\$20.75 SET** ⚠

**8380830TB** .....37-62  
Studs, washers & acorn nuts for OTB valve cover 0.413 -0 ..... **\$39.25 SET** ⚠

**Valve Cover Breather**



**OTB-6810FP** .....37-62  
Finned Polished Aluminum 90 Degree Mount -0 ..... **\$95.00 EA** ⚠



**OTB-6811F** .....37-62  
Finned Aluminum 90 Degree Mount -0 ..... **\$79.00 EA** ⚠



**WARNING:** Cancer and Reproductive Harm — www.P65Warnings.ca.gov

Chemicals shipped domestic ground only (Lower 48 states only). No international shipping.

**Phone: (360) 816-0211 • (800) 999-CHEV (2438) • www.chevsofthe40s.com**

**Valve Cover Breather, cont.**



**OTB-6801 . . . . . ALL**  
Finned polished aluminum. 1" dia. neck for 1-1/4" hole using a rubber grommet. -0.15

..... **\$61.75 EA** ⚠



**OTB-6805 . . . . . ALL**  
Finned polished aluminum. For use with Offenhauser or Wayne valve covers -0.15  
..... **\$60.25 EA** ⚠

**Oil Fill Cap**



**OTB-6152FP . . . . . 37-62**  
Finned Polished Aluminum Oil Cap 2-5/8" Dia 1" Tall -0

..... **\$42.50 EA** ⚠



**OTB-6153F . . . . . 37-62**  
Finned Aluminum Oil Cap 2-5/8" Dia 1" Tall -0

..... **\$34.75 EA** ⚠



**3835665 . . . . . 46-57**  
Breather on rocker cover, replacement. 0.386 -0.3

..... **\$8.50 EA** ⚠



**6150SP . . . . . ALL**  
Valve cover Sprocket Polished Oil Cap Polished Diameter - 3". Height - 1-1/8". -0

..... **\$51.50 EA** ⚠



**6151S . . . . . ALL**  
Valve cover Sprocket Unpolished Oil Cap Polished Diameter - 3". Height - 1-1/8". -0

..... **\$35.00 EA** ⚠

**Gasket Oil Fill Cap**



**836446 . . . . . 31-48**  
Oil Fill Cap Gasket. Exc 48 3/4T & larger 1.517 -0.2 ..... **\$2.25 EA** ⚠

**Cylinder Head Bolts**



**3837543 . . . . . 34-62**  
Long - Used 0.293 -0.15 ..... **\$4.75 EA** ⚠

**3837544 . . . . . 37-62**  
Short 0.293 -0.4

..... **\$4.75 EA** ⚠

**Rocker Assembly**



**838244B . . . . . 37-39**  
Fits 216ci (\$100 core) 0.352 -0.15 ..... **\$425.00 PR** ⚠

**609925 . . . . . 40**  
Fits 216ci (\$100 core) 0.352 -0.15 ..... **\$295.50 PR** ⚠

**609924 . . . . . 41-53**  
Fits 216ci (\$100 core) 0.352 -0.15 ..... **\$335.00 PR** ⚠

**3729191 . . . . . 50-58**  
235ci (\$100 core) 0.352 -0.15 ..... **\$365.00 PR** ⚠

**Rocker Arm Shaft**



**839592 . . . . . 40-58**  
Requires 2 0.353 -0 ..... **\$42.25 EA** ⚠

**Rocker Arm**



**837385B . . . . . 34-54**  
Adjusting screw & nut. 0.429 -0.15 ..... **\$15.00 EA** ⚠

**Valve**

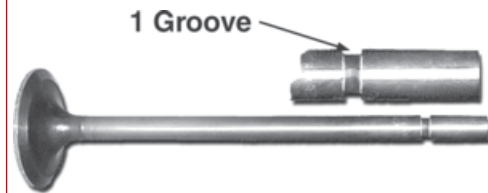

**838437 . . . . . 35-40**  
Intake 0.296 -0.15 ..... **\$15.50 EA** ⚠

**838717 . . . . . 35-40**  
Exhaust (1 groove) 0.297 -0.4

..... **\$15.50 EA** ⚠

**3835318 . . . . . 41-49**  
Exhaust (2 groove)

Note: replaces 839412 single groove. Must use 3835392 cap and 3835333 seal. 0.297 -0.15

..... **\$33.75 EA** ⚠

**839504 . . . . . 41-49**  
Intake (1 groove) 0.296 -0.4

..... **\$15.50 EA** ⚠

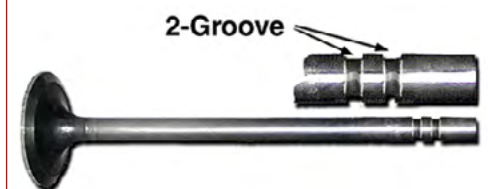

**3688065 . . . . . 41-53**  
Intake (2 groove) exc 50 & later 235ci. 0.296 -0.2 ..... **\$25.25 EA** ⚠

**3835608 . . . . . 41-53**  
Exhaust exc 50 & later 235ci (2 groove) 0.297 -0.15

..... **\$15.49 EA** ⚠

**3835519 . . . . . 50-52**  
Intake, 235ci only (1 groove). 0.296 -0.3

..... **\$15.50 EA** ⚠

**3683569 . . . . . 50-62**  
Exhaust, 216 1950-1953, 235 1950-1962 (2 grooves). 0.297 -0.4

..... **\$16.25 EA** ⚠

**3835910 . . . . . 53-62**  
Intake, 235ci only (2 grooves). 0.296 -0.15

..... **\$17.00 EA** ⚠

**Valve Springs**



**3835626 . . . . . 28-52**  
216ci engines 0.303 -0.15 ..... **\$4.75 EA** ⚠



**3704142 . . . . . 53-58**  
235ci & 261ci engines 0.303 -0.2 ..... **\$6.50 EA** ⚠



**Valve Spring Cap**



**837264N** ..... **35-42**  
Valve spring cap (NOS)  
0.309-0.15  
..... **\$2.00 EA** ⚠



**837624** ..... **35-47**  
Inlet (set of 6) 0.309-0  
..... **CALL** ⚠



**3835392N** ..... **47-48**  
Valve Spring Cap  
(NORS) 0.309-0.2  
..... **\$2.50 EA** ⚠

**Valve Stem Locks**



**838029** ..... **34-57**  
Key (12 pcs) 0.310-0.2  
..... **\$6.75 SET** ⚠

**Valve Seats**



**3688065A** ..... **38-52**  
Intake exc 50-52 235ci 0.296-0.3  
..... **\$7.50 EA** ⚠

**3835318A** ..... **38-52**  
Exhaust exc 50-52 235ci 0.297-0.3  
..... **\$7.00 EA** ⚠

**3683569A** ..... **50-52**  
Exhaust 235ci 0.297-0.15  
..... **\$10.00 EA** ⚠

**3835519A** ..... **50-62**  
Intake 235ci 0.296-0.3  
..... **\$6.75 EA** ⚠

**3683569B** ..... **53-62**  
Exhaust 235ci 0.297-0.15  
..... **\$5.00 EA** ⚠

**Valve Guide**



**3688758** ..... **38-40**  
Intake 0.283-0.15  
..... **\$6.50 EA** ⚠

**3688759** ..... **38-40**  
Exhaust 0.283-0.15  
..... **\$7.50 EA** ⚠

**3688761** ..... **41-62**  
Exhaust 0.283-0.15  
..... **\$7.25 EA** ⚠

**Valve Guide, cont.**

**3708168** ..... **41-62**  
Intake 0.283-0.3  
..... **\$6.75 EA** ⚠

**Valve Seals**



**3835333** ..... **38-57**  
12 pcs 0.308-0.3  
..... **\$7.50 SET** ⚠

**Lifters**



**838774** ..... **29-39**  
Solid 0.459-0.15  
..... **\$12.25 EA** ⚠



**839263A** ..... **37-55**  
Solid, NOS original  
40-55 (37-39 must  
be used w/ pushrods  
#3835776) 0.459-0.15  
..... **\$17.50 EA** ⚠



**5230850** ..... **50-58**  
Hydraulic, w/  
Powerglide 0.459-0.15  
..... **\$16.25 EA** ⚠

**Pushrods**



**3835776** ..... **37-53**  
10-1/4". Fits 216ci, 37-39, use w/ lifter  
#839263 0.426-0.3  
..... **\$13.75 EA** ⚠

**3836261** ..... **41-55**  
10-5/8". All 235ci exc Powerglide  
0.426-0.4  
..... **\$15.50 EA** ⚠

**3835777** ..... **50-62**  
11-1/4". All 235ci w/ Powerglide 0.426-0.3  
..... **\$15.50 EA** ⚠

**Camshaft**



**3836491** ..... **37-53**  
For solid lifters, new 0.519-0.15  
..... **\$153.25 EA** ⚠

**3836485** ..... **50-53**  
For hydraulic lifters, new 0.519-0.15  
..... **\$197.00 EA** ⚠

**3836485R** ..... **50-53**  
For hydraulic lifters, reground (\$100 core)  
0.519-0.2  
..... **\$125.00 EA** ⚠

**Camshaft, cont.**

**3713919** ..... **54-55**  
For solid lifters, new, exc Powerglide &  
261ci (for 261ci use part #3836484)  
0.519-0.15  
..... **\$134.25 EA** ⚠

**3713919R** ..... **54-55**  
For solid lifters reground (\$40 core) exc  
Powerglide & 261ci (for 261ci use part #  
383684R) 0.519-0.3  
..... **\$71.50 EA** ⚠

**3836484** ..... **54-58**  
For solid lifters, new, 235ci, 261ci  
0.519-0.15  
..... **\$135.00 EA** ⚠

**3836483** ..... **54-62**  
For hydraulic lifters, new 0.519-0.15  
..... **\$143.50 EA** ⚠

**3836483R** ..... **54-62**  
For hydraulic lifters, reground (\$40 core)  
0.519-0.15  
..... **\$71.50 EA** ⚠

**3836484R** ..... **54-62**  
For solid lifters, reground, 235ci, 261ci  
(\$40 core) 0.519-0  
..... **CALL** ⚠

**Camshaft Bearings**



**838846B** ..... **37-53**  
Camshaft bearings. 0.539-0.15  
..... **\$59.25 SET** ⚠

**3836191** ..... **54-58**  
Camshaft bearings 0.539-0.15  
..... **\$36.00 SET** ⚠

**Camshaft Thrust Plate & Spacer**



**3702305** ..... **37-57**  
Thrust plate & spacer 0.533-0.15  
..... **\$16.50 SET** ⚠

**Camshaft Thrust Plate Screws**



**3702305A** ..... **37-57**  
Thrust plate screws  
0.533-0.3  
..... **\$1.50 SET** ⚠



**WARNING:** Cancer and  
Reproductive Harm —  
www.P65Warnings.ca.gov

Chemicals shipped domestic ground only (Lower 48 states only). No international shipping.

**Phone: (360) 816-0211 • (800) 999-CHEV (2438) • www.chevsofthe40s.com**

**Timing Gear Cover**



**838869C.....37-62**

Timing gear cover chrome. Fits cars and trucks 1937-62 216ci, 235ci, 261ci also fits GMC 1939-1959 trucks with 228ci, 248ci, 270ci and 302ci engines -0

..... **\$54.25 EA** ⚠

**Timing Gear**



**3835371B.....37-62**

Aluminum crank & camshaft gear.

Matched set 0.728 -0.15 .. **\$122.75 SET**



**Woodruff Keys**



**106751.....ALL**

For harmonic balancer, crank and cam gears (3

pcs) 8.960 -0.4

..... **\$2.00 SET** ⚠

**Pistons**



**602806.....37-40**

Fits 216 Specify oversize (6 pcs) 0.629 -0.15

..... starting at **\$296.00 SET** ⚠

**605260.....41-53**

Fits 216 Specify oversize (6 pcs)

0.629 -0.15

..... starting at **\$267.00 SET** ⚠

**369398.....41-62**

Fits 235 Specify oversize (6 pcs)

0.629 -0.15

..... starting at **\$228.00 SET** ⚠

**3707460.....54-62**

Fits 261 Specify oversize (6 pcs)

0.629 -0.15

..... starting at **\$288.00 SET** ⚠

**Rings**



**608021.....37-53**

Fit 216ci (specify oversize) 0.643 -0.15

..... starting at **\$45.00 SET** ⚠

**370405.....41-53**

235ci exc 53 Powerglide (specify oversize) 0.643 -0.15

..... starting at **\$60.00 SET** ⚠

**370527.....53-54**

235ci exc 53 stick (specify oversize)

0.643 -0.2

..... starting at **\$60.00 SET** ⚠

**3720210.....54-62**

261ci (specify oversize) 0.643 -0.15

..... starting at **\$65.00 SET** ⚠

**Wrist Pins**



**838570.....37-62**

Standard 0.636 -0.15

..... **\$4.75 EA** ⚠

**Rod Service**

Note: Price subject to bearing availability. Before grinding crank shaft, please contact us to be sure undersize bearings needed are available.



**602235A.....37-53**

Send in your rods and we will machine them for insert bearings. 0.603 -0

**\$77.50 EA** ⚠

**Rod**

Note: SPECIFY exact model engine with rod casting number when possible. \$35 core charge refundable on rebuildable rod.

**602235M.....37-47**

Machined for insert bearing (NOS) 0.603 -0

..... **\$125.00 EA** ⚠

**602235N.....37-47**

Babbitt rods. Standard size only (NOS).

0.603 -0.4

..... **\$54.00 EA** ⚠

**Rod Bolt & Nut**



**3835449.....33-53**

Except 53 Powerglide 0.623 -0.15

..... **\$5.50 EA** ⚠



**107823.....ALL**

Pal lock nuts for rod bolts 0.626 -0.4

..... **\$11.00 SET** ⚠

**Rod Bolt Boots**



**986047B.....ALL**

Protects crankshaft during assembly

8.800 -0.15

..... **\$2.75 PR** ⚠



**986047BB.....ALL**

Protects crankshaft during assembly

8.800 -0.15

..... **\$5.00 SET** ⚠

**Alignment Tool**



**38352226.....37-53**

Tool used to align oil dipper troughs in pan (\$375 refundable deposit upon return of tool) 1.427 -0.15

..... starting at **\$477.00 Rent** ⚠

**Rod Dipper**



**3834884.....33-53**

Used. For connecting rod. 0.604 -0.15

..... **\$4.99 EA** ⚠

**Rod Bearing Shims**



**3692517.....29-53**

.009 thick shims for rod bearings, 12 per set.

0.619 -0.15

..... **\$47.75 SET** ⚠



**Rod Bearings**



- 370485** ..... **37-53**  
Standard size to .060. (exc '53 Powerglide). 0.616 -0.15 ..... starting at **\$200.00 SET** ⚠
- 370486** ..... **53-62**  
Except 53 stick 0.616 -0.15 ..... starting at **\$154.00 SET** ⚠

**Main Bearings Shims**



- 609118B** ..... **40-53**  
Shims for main bearings. 0.143 -0.15 ..... **\$54.00 SET** ⚠

**Main Bearings**



- 384706** ..... **37-39**  
Standard to .075 under. 0.099 -0.15 ..... starting at **\$250.00 SET** ⚠
- 384206** ..... **40-47**  
Standard size to .075 under. 0.099 -0.15 ..... starting at **\$251.00 SET** ⚠
- 368847** ..... **48-53**  
Standard, .002, .010, .020, .030 exc 53 Powerglide. 0.099 -0.15 ..... starting at **\$210.00 SET** ⚠
- 368855** ..... **48-53**  
.040, .050, .060 (exc 53 Powerglide). 0.099 -0.15 ..... starting at **\$130.00 SET** ⚠
- 370394** ..... **53-62**  
Standard to .040 exc 53 stick. 0.099 -0.15 ..... starting at **\$106.00 SET** ⚠

**Plastigauge**



- 609118P** ..... **ALL**  
To check bearing clearance. 0.143 -0.15 ..... **\$6.50 EA** ⚠

**Dampener Balancer**



- 605203** ..... **37-54**  
Sleeve, repair seal surface on crank dampner 0.659 -0.2 ..... **\$8.00 EA** ⚠
- 605635** ..... **ALL**  
Recondition yours. 216ci, 235ci engines. 0.659 -0.15 ..... **\$199.50 EA** ⚠

**Stove Bolt**



- 839301** ..... **40-60**  
W/ lock washer correct for timing cover, pushrod cover & oil pan (8 pcs) 1.428 -0 ..... **\$6.00 SET** ⚠

**Timing Hole Plug**



- 836802A** ..... **ALL**  
Rubber (rare) 0.714 -0.15 ..... **\$7.75 EA** ⚠

**Engine Bolt Kit Stainless Steel**



- 368253A** ..... **37-53**  
Hex head Chevy 216ci (exc 53 powerglide) includes bolts for distributor, side cover, valve cover, timing cover, thermostat, oil pan, intake & exhaust, fuel pump & water pump, also includes lube. 0.386 -0.15 ..... **\$68.50 SET** ⚠
- 3836614A** ..... **53-54**  
Hex head for a Chevy 235ci engine. Includes bolts for distributor, side cover, valve cover, timing cover, thermostat, oil pan, intake & exhaust, fuel pump & water pump and lube. 0.386 -0.15 ..... **\$74.00 SET** ⚠

**Engine Bolt Kit Stainless Steel, cont.**



- 3836614B** ..... **55-62**  
Hex head for a Chevy 235/ 261ci engine. Includes bolts for distributor, side cover, valve cover, timing cover, thermostat, oil pan, intake & exhaust, fuel pump & water pump and lube. 0.386 -0.15 ..... **\$74.00 SET** ⚠

**Manifold Clamps & Bolts**



- 838546B** ..... **37-57**  
Intake - Exhaust manifold clamps (spreaders). Cast reproduction. 3.273 -0 ..... **CALL** ⚠
- 838546BK** ..... **37-57**  
Intake - Exhaust manifold bolt kit 3.273 -0 ..... **\$5.00 SET** ⚠
- 838546U** ..... **37-57**  
Intake - Exhaust manifold clamps (spreaders). used 3.273 -0 ..... **\$35.00 SET** ⚠

**Manifold Sleeves (Metal)**



- 837273** ..... **34-53**  
Intake to head 216ci. Exc 50-53 235ci (3 piece set) 3.281 -0.15 ..... **\$7.50 SET** ⚠
- 3835506** ..... **50-62**  
Intake to head 235ci, 261ci (3 piece set) 3.281 -0.15 ..... **\$7.50 SET** ⚠

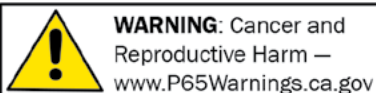

Chemicals shipped domestic ground only (Lower 48 states only). No international shipping.

**Phone: (360) 816-0211 • (800) 999-CHEV (2438) • www.chevsofthe40s.com**

**Engine Assembly Lube**

Synthetic oils enable Royal Purple to make superior lubricants, but it is Royal Purple's advanced Synslide additive technology that gives Royal Purple's EP lubricants their amazing performance. Engine Performance magazine raves about this product.



**986047** .....ALL  
Clevite Bearing Guard, 8 oz bottle.  
8.800 -0.15  
..... **\$10.00 EA** ⚠



**986047D** .....ALL  
Royal Purple Synthetic, 8 oz bottle. 8.800 -0.15  
..... **\$21.50 EA** ⚠

**Soft Plug Set**



**3835121** .....37-54  
For complete plug kit you'll also need expansion plug #838127 0.034 -0.2  
..... **\$8.50 SET** ⚠

**Expansion Plug**



**838127** .....38-54  
Block, rear of camshaft 1-31/32in. 0.553 -0.15  
..... **\$2.50 EA** ⚠



**838128** .....38-54  
Block, rear of camshaft 1-5/8in. 0.553 -0.4  
..... **\$15.00 EA** ⚠

**Oil Pan Plug**



**344690** .....28-57  
W/ washer, 1/2 in., standard size 1.456 -0.4  
..... **\$3.19 EA** ⚠

**Oil Pan Plug, cont.**

**344690B** .....28-57  
W/ washer, 1/2 in., single oversize 1.456 -0.2  
..... **\$3.75 EA** ⚠

**344690C** .....28-57  
W/ washer, 1/2 in., double oversize 1.456 -0.15  
..... **\$2.50 EA** ⚠

**344690D** .....28-57  
W/ washer, 1/2 in., triple oversize 1.456 -0.15  
..... **\$2.50 EA** ⚠

**Oil Dip Stick Tube**



**3685702** .....47-57  
Cut to length 8-7/64in. 1.516 -0  
..... **CALL** ⚠

**Oil Pressure Line**



**609912** .....36-53  
Rocker arm, exc Powerglide w/ 235ci 1.519 -0.15  
..... **CALL** ⚠



**1399637B** .....37-54  
Engine to oil gauge. 1.519 -0.3  
..... **\$26.00 EA** ⚠



**217276A** .....50-55  
NOS rocker arm oiler kit 1.519 -0.15  
..... **\$15.00 EA** ⚠

**Oil Distributor Valve**



**839173** .....40-53  
Oil Distributor Valve Gasket 1.790 -0.3  
..... **\$2.75 EA** ⚠

**Oil Pickup Grommet**



**3701563** .....53-54  
Grommet, oil pickup tube to screen assembly 1.664 -0  
..... **\$1.75 EA** ⚠

**Oil Pump**



**838440** .....37-39  
For 216ci engine 1.652 -0.15  
..... **\$195.00 EA** ⚠



**839157** .....40-53  
Fits 216 & 235ci (exc 53 Powerglide). 1.652 -0.15  
..... **\$299.00 EA** ⚠



**3702363** .....53-54  
Fits 235ci, exc 53 stick 1.652 -0.15  
..... **\$195.00 EA** ⚠

**Oil Pump Rebuild Kit**



**839157A** .....40-53  
Rebuild kit, exc Powerglide 1.652 -0  
..... **CALL** ⚠



**3702363A** .....53-54  
Rebuild kit, exc 53 stick 1.652 -0.15  
..... **\$75.00 EA** ⚠

**Oil Pump Drive Gear**



**839164** .....40-53  
Drive gear. Exc 53 Powerglide (NOS) 1.659 -0.4  
..... **\$5.00 EA** ⚠



**Bee Hive Oil Filter**



**5573017A** .....ALL  
 Super reproduction, painted. Hard to find item 1.836 -0.15 ..... **\$255.75 EA** ⚠



**5573017C** .....ALL  
 Mount bracket for Bee Hive Oil Filter, painted 1.836 -0.15 ..... **\$29.50 EA** ⚠



**5573017FILT** .....ALL  
 Filter Element for Beehive, 5" x 4" 1.836 -0.15 ..... **\$14.25 EA** ⚠



**5573017GASK** .....ALL  
 Gasket For Beehive Filter 1.836 -0.15 ..... **\$2.75 EA** ⚠

**Oil Filter Element**



**5572288A** .....ALL  
 3-1/2 in. o.d. x 4-1/16 in. high, #P203. 1-1/8 in. I.D. 1.836 -0.15 ..... **\$16.50 EA** ⚠



**5572288B** .....ALL  
 4-1/16 in. o.d. x 4-11/16 in. high. 1.836 -0.15 ..... **\$18.50 EA** ⚠



**5572288C** .....ALL  
 4-1/4 in. o.d. x 5 in. high, #P115 I.D. 9/16 in. 1.836 -0.15 ..... **\$26.25 EA** ⚠

**Oil Filter Element, cont.**



**5572288D** .....ALL  
 4-1/16 in. o.d. x 7-3/4 in. high, #P117. Inside hole 9/16 in. i.d. 1.836 -0.15 ..... **\$12.25 EA** ⚠

**Oil Filter Hose**



**3654629** .....29-54  
 19 in. 3.163 -0.15 ..... **\$33.50 EA** ⚠

**3702341** .....37-54  
 13 in. 3.163 -0.15 ..... **\$33.50 EA** ⚠

**Odds & Ends**

Please call for availability on all Odds & Ends parts; once part is sold, it may no longer be in stock.

**605487N** .....29-32  
 Connecting rod bolts NOS 0.623 -0 ..... **\$23.00 EA** ⚠

**362477** .....29-36  
 Wrist Pins, .003 O.S. (NOS) 1.000 -0.4 ..... **\$6.00 SET** ⚠

**838774N** .....29-39  
 Lifters (Solid) (NOS) 0.459 -0.2 ..... **\$22.00 EA** ⚠

**609533N** .....33-36  
 Timing Gear Cover (NOS) 0.206 -0.4 ..... **\$65.00 EA** ⚠

**836867** .....33-36  
 Rocker Arm Shaft Oil Connector (NOS) 1.928 -0.4 ..... **\$12.00 EA** ⚠

**837365** .....34-37  
 Valve Spring All exc dc 0.303 -0.3 ..... **\$3.75 EA** ⚠

**838999** .....34-40  
 Rocker Arm- Exhaust 0.333 -0.4 ..... **\$7.00 EA** ⚠

**837385U** .....34-54  
 Rocker arm & nut used 0.429 -0.4 ..... **\$5.00 EA** ⚠

**837656** .....35-36  
 Oil pan seal at front crankcase. NOS-shelf worn. 0.213 -0.2 ..... **\$3.00 EA** ⚠

**Odds & Ends, cont.**



**837264N** .....35-42  
 Valve spring cap (NOS) 0.309 -0.15 ..... **\$2.00 EA** ⚠

**00195** .....37-39  
 Small spring around pushrod, inside -0.3 ..... **\$4.00 EA** ⚠

**838220** .....37-39  
 Rocker Shaft Sleeve 1/8in. Id On One End, 1/2in. Id On Other End 1.928 -0.15 ..... **\$2.00 EA** ⚠

**838963N** .....37-39  
 Body oil distributor valve (NOS) 1.785 -0.4 ..... **\$20.00 EA** ⚠

**6028060N** .....37-40  
 Pistons. Fits 216ci standard bore (NOS). 0.629 -0.4 ..... **\$41.75 EA** ⚠

**60280660A** .....37-40  
 Piston .060in. 0.629 -0.4 ..... **\$45.00 EA** ⚠

**60280680A** .....37-40  
 Pistons .080in. (NOS) 0.629 -0.4 ..... **\$35.00 EA** ⚠

**60280680N** .....37-40  
 Pistons. 216ci Engine .080 over (NOS) 0.629 -0.4 ..... **\$200.00 SET** ⚠

**838993** .....37-40  
 Rocker Arm- Left Intake 0.333 -0.4 ..... **\$7.00 EA** ⚠

**838994** .....37-40  
 Rocker Arm- Right Intake 0.333 -0.4 ..... **\$7.00 EA** ⚠

**3847065N** .....37-47  
 Main bearing-front intermediate 0.099 -0.4 ..... **\$10.00 EA** ⚠

**00205** .....37-53  
 Cambearings .030 (NOS) 0.539 -0.4 ..... **\$15.50 SET** ⚠

**3835246** .....37-53  
 Pushrod cover seal. Cork. Fits all 216ci 0.454 -0.4 ..... **\$1.00 EA** ⚠

**3835344** .....37-53  
 Push rod cover. Fits 216ci (Used) 1.000 -0.4 ..... **\$25.00 EA** ⚠



**608202** .....37-53  
 Rings for 216ci .020 (NOS) 0.643 -0.4 ..... **\$60.00 SET** ⚠

**838246** .....37-53  
 Rocker shaft support with 216 0.349 -0.4 ..... **\$40.00 EA** ⚠

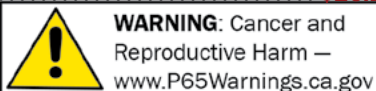

**WARNING:** Cancer and Reproductive Harm — www.P65Warnings.ca.gov

Chemicals shipped domestic ground only (Lower 48 states only). No international shipping.

**Phone: (360) 816-0211 • (800) 999-CHEV (2438) • www.chevsofthe40s.com**

## Odds & Ends, cont.

- 838483** ..... **37-53**  
Flywheel Shield Extensions. 0.679 -0.4  
..... **\$15.00 EA** ⚠
- 355936** ..... **37-54**  
Valve rocker shaft retainer hair pin  
0.376 -0.4  
..... **\$5.00 EA** ⚠
- 3835508** ..... **37-54**  
Rocker arm shaft spring (2-5/16" length)  
0.376 -0.4  
..... **\$8.00 EA** ⚠
- 602325** ..... **37-57**  
Shims for crankshaft front bearing  
0.146 -0.4  
..... **\$5.00 SET** ⚠
- 839304** ..... **38-50**  
Spring Valve All Exc PG (NOS) 0.603 -0.2  
..... **\$3.00 EA** ⚠
- 609121** ..... **40-50**  
Shims for crankshaft rear bearing  
0.153 -0.4  
..... **\$5.00 EA** ⚠
- 3712747** ..... **40-52**  
Pipe & Cover Oil Pump (NOS) 1.664 -0.4  
..... **\$20.00 EA** ⚠
- 839897** ..... **41-48**  
Valve Spring Cap-Exhaust 0.309 -0.15  
..... **\$2.00 EA** ⚠
- 3695373** ..... **41-55**  
Exhaust Valve Rotor Assembly 0.309 -0.2  
..... **\$3.00 EA** ⚠
- 3835392N** ..... **47-48**  
Valve Spring Cap  
(NORS) 0.309 -0.2  
..... **\$2.50 EA** ⚠
- 
- 3701556** ..... **47-49**  
Oil Dipstick NOS (Comm & Utility).  
1000.000 -0.4  
..... **\$15.00 EA** ⚠
- 3835548** ..... **50**  
Rocker Arm. Exhaust, 235ci Engine  
0.333 -0.4  
..... **\$16.00 EA** ⚠
- 3701490** ..... **53-61**  
Connecting Rod (fits 53 Pg & All 54-61)  
0.603 -0.4  
..... **\$75.00 EA** ⚠
- 3836090** ..... **54-56**  
Rotator-Exhaust Valve, 1.5 Ton 0.309 -0.2  
..... **\$3.00 EA** ⚠
- 3731676** ..... **54-60**  
Piston ring set. NOS, fits 261ci engine,  
standard bore. 0.643 -0.4  
..... **\$60.00 SET** ⚠

## Odds & Ends, cont.

- 3836026** ..... **55**  
Exhaust Valves (Pass Exc P/g) (NOS)  
0.297 -0.4  
..... **\$10.00 EA** ⚠
- 3728993N** ..... **55-57**  
Rear main bearings (NOS) 0.960 -0.4  
..... **\$15.00 PR** ⚠
- 3836755** ..... **57**  
Valve spring cap cover V-8 0.308 -0.4  
..... **\$10.00 SET** ⚠
- 3730859** ..... **57-58**  
Exhaust Valve, All exc Powerglide 1.000 -0.3  
..... **\$4.00 EA** ⚠
- 38355144** ..... **ALL**  
Push rod cover used 235ci (10 bolt holes  
5-21/32 x 27) 0.439 -0  
..... **\$25.00 EA** ⚠
- 955-INEX** ..... **ALL**  
Oil Regulator Valve Silencing Cap 0.303 -0.4  
..... **\$20.00 SET** ⚠



**SECTION 024T  
RESTORATION PARTS**

**Overhaul Gasket**

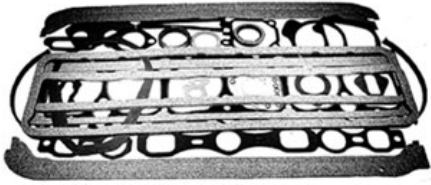

**3702872** ..... **37-53**  
Overhaul complete set. All 216ci (exc 53  
P.G.) 0.010 -0.15 ..... **\$120.75 SET** ⚠

**3702872A** ..... **50-52**  
Overhaul complete set. Fits 235ci. 0.010 -0  
..... **\$199.00 SET** ⚠



**3719628** ..... **53-62**  
Overhaul complete set. Fits 235ci  
0.010 -0.15 ..... **\$117.00 SET** ⚠



**3836107B** ..... **54-62**  
Overhaul complete set. Fits 261ci  
0.010 -0.15 ..... **\$112.25 SET** ⚠

**Valve Grind Gasket**

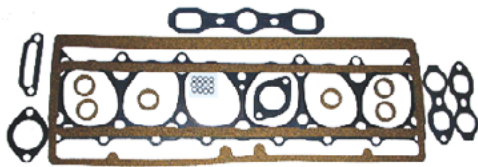

**3691929** ..... **37-53**  
Valve Grind Exc 50-53 235ci. 0.289 -0.15  
..... **\$74.00 SET** ⚠



**3707038** ..... **50-53**  
Valve Grind Fits 235ci, exc 53 Powerglide.  
0.289 -0.15 ..... **\$65.25 SET** ⚠

**Valve Grind Gasket, cont.**



**3709428** ..... **53-62**  
Valve Grind Fits 235ci, exc 53 manual  
trans 0.289 -0.15 ..... **\$80.00 SET** ⚠



**3709429** ..... **54-57**  
Valve Grind Fits 261ci 0.289 -0.15 .....  
**\$59.00 SET** ⚠

**Valve Cover Gasket**



**3694248** ..... **37-53**  
Valve cover 1/4in. thick 0.423 -0.15 .....  
**\$13.00 EA** ⚠



**3696781** ..... **54-62**  
Valve cover cork. 0.423 -0.15 ..... **\$16.50 EA**  
⚠

**Push Rod Cover Gasket**



**602336** ..... **37-53**  
Push rod Cover Gasket w/ plug seals. Exc  
50-53 235ci 0.443 -0.15 ..... **\$29.00 SET**  
⚠

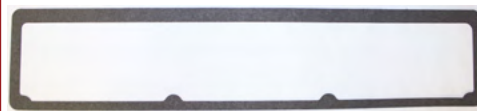

**3835515** ..... **50-62**  
Push rod Cover Paper. Fits 235ci & 261ci  
0.443 -0.15 ..... **\$16.75 SET** ⚠

**Head Gasket**



**839541** ..... **37-53**  
Head 216ci motor. 0.289 -0.15 .....  
**\$56.00 EA** ⚠



**3835562** ..... **50-52**  
Head 235ci motor 0.289 -0.15 .....  
**\$102.75 EA** ⚠

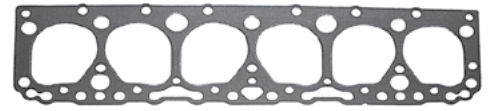

**3701296** ..... **53-62**  
Head 235ci motor 0.289 -0.15 .....  
**\$63.50 EA** ⚠



**3836107** ..... **54-62**  
Head 261ci 0.289 -0.15 .. **\$83.75 EA** ⚠

**Intake & Exhaust Manifold Gasket**



**602483A** ..... **37-53**  
Intake & exhaust  
manifold. Fits 216ci

(3pcs) 3.270 -0.15 ..... **\$18.50 SET** ⚠



**3707045** ..... **50-62**  
Intake & exhaust manifold. Fits 235ci &  
261ci (3pcs) 3.270 -0.15 ..... **\$17.50 SET**  
⚠

**Manifold Gasket**



**838290** ..... **37-53**  
Rectangle between  
manifolds. Fits 216ci  
3.272 -0.15  
..... **\$6.25 EA** ⚠



**WARNING:** Cancer and  
Reproductive Harm —  
www.P65Warnings.ca.gov

Chemicals shipped domestic ground only (Lower 48 states only). No international shipping.

**Phone: (360) 816-0211 • (800) 999-CHEV (2438) • www.chevsofthe40s.com**

# Section 024T: Engine Gaskets & Seals

## Manifold Gasket, cont.



**3835572** .....50-62  
 Rectangle between manifolds. Fits 235ci & 261ci 3.272 -0.15  
 ..... **\$7.50 EA** ⚠

## Timing Cover Gasket



**839048B** .....37-62  
 Timing Cover Complete set w/ seal  
 0.005 -0.15 ..... **\$26.50 SET** ⚠

## Timing Cover Seal



**3835946** .....37-58  
 Front of timing cover.  
 0.209 -0.3 ..... **\$13.75 EA** ⚠



**3835946N** .....37-58  
 Font of timing cover.  
 NOS 0.209 -0.3 ..... **\$8.00 EA** ⚠

## Woodruff Keys



**106751** .....ALL  
 For harmonic balancer, crank and cam gears (3

pcs) 8.960 -0.4  
 ..... **\$2.00 SET** ⚠

## Rear Main Seal



**3835774G** .....40-58  
 As original rope. Replaces original asbestos type. Graphite (2 pcs). 0.137 -0.15  
 ..... **\$28.25 EA** ⚠



**3835774R** .....56-62  
 Rubber (2 pcs) 235-261 0.137 -0.15  
**\$48.25 SET** ⚠

## Oil Fill Cap Gasket



**836446** .....31-48  
 Oil Fill Cap Gasket. Exc 48 3/4T & larger  
 1.517 -0.2 ..... **\$2.25 EA** ⚠

## Oil Pan Gasket



**602373** .....37-39  
 Oil pan 1.429 -0.15 ..... **\$19.75 SET** ⚠



**604338** .....40-55  
 Oil pan 1.429 -0.15 ..... **\$19.00 SET** ⚠

## Oil Distributor Valve Gasket



**839173** .....40-53  
 Oil Distributor Valve Gasket 1.790 -0.3  
 ..... **\$2.75 EA** ⚠

## Gasket Sealer

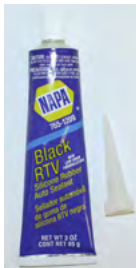

**1015BP** .....ALL  
 Gasket sealer, high temp silicone. Black (3.35 oz tube).  
 8.800 -0.15  
 ..... **\$10.00 EA** ⚠

## Engine Assembly Lube



**986047** .....ALL  
 Clevite Bearing Guard, 8 oz bottle.  
 8.800 -0.15  
 ..... **\$10.00 EA** ⚠



**986047D** .....ALL  
 Royal Purple. Synthetic, 8 oz bottle. 8.800 -0.15  
 ..... **\$21.50 EA** ⚠





**SECTION 026T  
STREET ROD PARTS**

**Crossmember V8 Conversion**



**3716772.....47-54**  
Motor mount crossmember will work for 40-46 truck if cut 1" from each end.  
0.029 -0.15 ..... **\$70.75 EA** ⚠️

**SECTION 026T  
RESTORATION PARTS**

**Motor Mount Front**



**3739939 .....33-59**  
Also fits 39-54 GMC. 0.027 -0.15 .....  
**\$12.50 EA** ⚠️



**3656502 .....37-54**  
Metal cover for front motor mount.  
0.029 -0.15 ..... **\$12.00 EA** ⚠️

**Motor Mount Rear**



**3702198.....37-53**  
Chevy & 39-53 GMC (Exc 48-53 Chevy 1/2T & 47 2nd design). 0.027 -0.2 .....  
**\$22.50 EA** ⚠️



**756700.....47-53**  
1/2T (47-2nd design). 0.027 -0.2 .....  
**\$15.00 EA** ⚠️



**3705444 ..... 54**  
Upper 0.027 -0.3 ..... **\$17.00 EA** ⚠️



**3789949 ..... 54**  
Lower 0.027 -0.4 ..... **\$10.00 EA** ⚠️

**Odds & Ends**

Please call for availability on all Odds & Ends parts; once part is sold, it may no longer be in stock.

**602790.....37-46**  
Cushion-motor Mount Bracket Assy (Accy) Heater 0.027 -0.4  
..... **\$45.00 PR** ⚠️

**602787.....37-50**  
Rear bracket for cushioned motor mount 0.027 -0.4  
..... **\$15.00 EA** ⚠️

**SECTION 030T  
STREET ROD PARTS**

**Radiator V8 (Copper-Brass)**

Oversize shipping charges apply on radiators.  
Please call for rate.



**3118968A** .....47-54  
Chevy Truck W/ V8 small block, 4 core w/  
trans cooler. 1.219 -0.15 **\$435.00 EA** ⚠

**Radiator V8 (Aluminum) W/  
Stamped Tanks**



**3116352A** .....41-46  
100% TIG welded  
All Aluminum  
(2) 1.25" Tubes  
Polished tanks  
16 fins per inch  
Corrugated fins that give more surface  
area and more thermal transfer  
Pressure tested  
For maunal trans  
Direct fitment for 41-46 Chevy Truck  
Upper Hose 1.50"  
Lower Hose 1.75" 1.219 -0 **\$469.00 EA**  
⚠



**3118968AL** .....47-54  
V8 Chevy Trucks 1.219 -0.15 **\$278.00 EA**  
⚠

**Radiator V8 (Aluminum) W/  
Stamped Tanks, cont.**



**3118968AG** .....48-54  
100% TIG welded  
All Aluminum  
(2) 1.25" Tubes  
Polished tanks  
16 fins per inch  
Corrugated fins that give more surface  
area and more thermal transfer  
Pressure tested  
For maunal trans  
Direct fitment for 48-54 GMC Truck  
Upper Hose 1.50"  
Lower Hose 1.75" 1.219 -0 **\$452.00 EA**  
⚠

**Radiator V8 (Aluminum) Chevy  
ALUMRAD**

**ALUMRAD** .....37-53  
Chevy Type 1 size: 18"W x 27"H. 1.219 -0.15  
.....**\$557.75 EA** ⚠  
**ALUMRADT** .....37-53  
Chevy Type 1 - 18"Wx27"H W/ internal  
transmission cooler. 1.219 -0.15  
.....**\$630.25 EA** ⚠  
**ALUMRAD** .....46-54  
Chevy Type 2 size: 20-1/4"W x 24-1/2"H.  
1.219 -0.15 .....**\$494.39 EA** ⚠  
**ALUMRADT** .....46-54  
Chevy Type 2. 20-1/4"W x 24-1/2"H W/  
internal transmission cooler. 1.219 -0.15  
.....**\$566.50 EA** ⚠

**Radiator (Aluminum) GMC  
ALUMRAD**

**ALUMRADG** .....37-54  
GMC Rear mount. Size: 18"W x 27"H.  
1.219 -0.15  
.....**\$557.75 EA** ⚠  
**ALUMRADGT** .....37-54  
GMC Rear mount. Size: 18"W x 27"H. w/  
internal trans cooler. 1.219 -0.15  
.....**\$566.50 EA** ⚠

**Radiator (Aluminum) ALUMRAD  
Upgrades**

**ALUMRADACCON** ..... ALL  
Add an AC Condenser 1.219 -0.15  
.....**\$99.75 EA** ⚠

**Radiator (Aluminum) ALUMRAD  
Upgrades, cont.**

**ALUMRADACMOUNT** ..... ALL  
Mount AC condenser to radiator 1.219 -0.15  
.....**\$40.00 EA** ⚠  
**ALUMRADBUNG** .....ALL  
Extra bung welded in radiator. 1.219 -0.15  
.....**\$15.00 EA** ⚠  
**ALUMRADFAN** ..... ALL  
Electric fan for aluminum radiators. 16",  
2360CFM. Straight fan blades. 1.219 -0.15  
.....**\$150.25 EA** ⚠  
**ALUMRADFANCOVER** ..... ALL  
Polished aluminum fan cover for electric  
fan. 1.219 -0.15  
.....**\$60.25 EA** ⚠  
**ALUMRADFANMOUNT** ..... ALL  
Mount Fan to radiator 1.219 -0  
.....**\$65.00 EA** ⚠  
**ALUMRADFANWIRE** ..... ALL  
Single Fan Wiring Harness 1.219 -0  
.....**\$56.00 EA** ⚠  
**ALUMRADSHROUD** .....ALL  
Aluminum fan shroud for radiators listed  
above. 1.219 -0.15  
.....**\$99.75 EA** ⚠  
**POLISHRAD** ..... ALL  
Upgrade your radiator to a fully polished.  
1.219 -0  
.....**\$125.00 EA** ⚠  
**POLISHSHROUD** .....ALL  
Upgrade fan shroud to polished 1.219 -0.15  
.....**\$40.00 EA** ⚠

**Radiator Cap (Aluminum)**



**ALUMCAP16PRC** . .ALL  
Billet aluminum radiator  
cap. 16lb. Smooth with  
"PRC" logo. 0.000 -0.15  
.....**\$19.99 EA** ⚠

**SECTION 030T  
RESTORATION PARTS**

**Radiator Core Support**



**3707011** .....47-55  
For center fill radiator.  
1.270 -0.15  
.....**\$371.25 EA** ⚠



**Core Support Pads & Shims**



**367314** ..... **39-46**  
Radiator core support mount. 4-1/4" x 1-1/2" (2-1/2" between bolt holes).  
1.270-0.3 ..... **\$10.50 SET** ⚠



**3684763A** ..... **47-49**  
Radiator core support mount. 2-1/4" x 1-1/4" x 1/4" thick. 1.270-0.15

..... **\$9.00 SET** ⚠



**3684763** ..... **50-54**  
Radiator core support mount. 1.270-0.15  
..... **\$6.75 PR** ⚠

**Core Support Bolt Kit**



**3676480** ..... **41-54**  
Radiator core support to frame. 1.270-0.4  
..... **\$4.00 SET** ⚠

**Brace (V-Rod) Street Rod**



**594773** ..... **37-38**  
For 37-38 Chevy Trucks. Stainless Steel.  
1.309-0 ..... **CALL** ⚠

**Radiator (Copper-Brass)**

Oversize shipping charges apply. Please call for rate.



**3109423** ..... **38-40**  
6 cylinder, 3 core 1.219-0 ..... **CALL** ⚠

**Radiator (Copper-Brass), cont.**

**3116352** ..... **41-46**  
6 cylinder, 3 core. 1.219-0  
..... **CALL** ⚠



**3118968** ..... **47-54**  
6 cylinder, 3 core. 1.219-0.15 .....  
**\$396.25 EA** ⚠

**Radiator Cap**



**370683** ..... **34-36**  
Seahorse (accessory). 1.203-0 .. **CALL**  
⚠



**594498** ..... **37-52**  
No pressure. 1.203-0.2 ..... **\$9.25 EA** ⚠



**594498AC** ..... **37-52**  
AC Delco RC-10. No pressure. 1.203-0  
**\$33.50 EA** ⚠



**850501** ..... **53-54**  
4 lb genuine AC. 1.203-0.15 ..... **\$15.50 EA**  
⚠

**Radiator Cap, cont.**



**850795R** ..... **53-57**  
7 lbs. 1.203-0 ..... **\$7.50 EA** ⚠



**850795** ..... **55-57**  
7 lb genuine AC. 1.203-0.15 ..... **\$16.00 EA**  
⚠

**Radiator Petcock**



**134519** ..... **37-39**  
Not as original.  
1.229-0.15

..... **\$4.00 EA** ⚠



**3113456** ..... **40-47**  
1/4" NPT 1.229-0.15

..... **\$20.00 EA** ⚠



**3719518** ..... **48-57**  
1/4" NPT 1.229-0.4

..... **\$6.00 EA** ⚠

**Overflow Tank**



**985528** ..... **37-54**  
Original GM accessory with hose, mounting bracket and screws  
1.290-0.15  
..... **\$127.25 EA** ⚠

**Overflow Tank Decal**



**DEC03** ..... **39-48**  
Gold with red wings. 19.200-0.4 .....  
**\$5.00 EA** ⚠

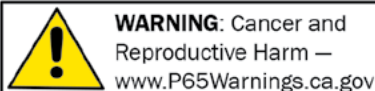

Chemicals shipped domestic ground only (Lower 48 states only). No international shipping.

Phone: (360) 816-0211 • (800) 999-CHEV (2438) • www.chevsofthe40s.com

**Overflow Tank Decal, cont.**



**DEC28** ..... **.49-54**  
 Clear with orange lettering. 19.200 -0.15  
 ..... **\$9.00 EA** ⚠

**Overflow Tank Hose Set**



**601607B** ..... **.37-48**  
 For accessory overflow tank w/ original  
 GM instruction sheet 1.240 -0.4  
 ..... **\$14.50 SET** ⚠



**601607C** ..... **.49-54**  
 For accessory overflow tank w/ original  
 GM instruction sheet 1.240 -0.4  
 ..... **\$14.50 SET** ⚠

**Radiator Hose Set**

**2782488** ..... **.37-40**  
 W/ metal elbow. 1.159 -0.2  
 ..... **CALL** ⚠

**2782488A** ..... **.41-46**  
 W/ metal elbow. 1.159 -0  
 ..... **CALL** ⚠

**3694277B** ..... **.47-54**  
 Molded hose with clamps. 1.173 -0.2  
 ..... **CALL** ⚠

**Upper Hose**

**364382P** ..... **.37-46**  
 6-3/4 in. 1.130 -0.25  
 ..... **\$6.50 EA** ⚠

**3702348** ..... **.47-54**  
 Molded hose 1.159 -0.2  
 ..... **\$8.00 EA** ⚠

**Metal Elbow**



**378248** ..... **.35-40**  
 In lower hose. 1.173 -0.15 ..... **\$17.50 EA** ⚠



**3656796** ..... **.41-46**  
 In lower hose. 1.173 -0.15  
 ..... **\$19.00 EA** ⚠

**Lower Hoses**

**3701363A** ..... **.37-40**  
 (2 pcs) (hoses are trim-to-fit). 1.159 -0.2  
 ..... **\$12.00 SET** ⚠

**3701363B** ..... **.41-46**  
 (2 pcs). 1.159 -0.2  
 ..... **\$12.00 SET** ⚠

**Moulded Lower Hose**

**3692230** ..... **.41-46**  
 Replaces metal elbow & 2 hoses.  
 1.173 -0.2  
 ..... **\$15.75 EA** ⚠

**3694277** ..... **.47-54**  
 Repro. 1.173 -0.15  
 ..... **CALL** ⚠

**Radiator Hose Clamps**



**111616** ..... **.ALL**  
 Upper hose (original) (2 pcs). 1.166 -0.2  
 ..... **\$4.50 SET** ⚠



**111619** ..... **.ALL**  
 Lower hose (original) (2 pcs). 1-7/8"  
 hoses. 5/8" band. 1.166 -0.2  
 ..... **\$4.50 SET** ⚠

**Water Pump**

Note: 1937-38 & 1939-40 cores are becoming difficult to find. You may be required to send in your core for a rebuild.



**3741033** ..... **.29-54**  
 W/ short shaft (narrow) 3/8" pulley (not polished). For use on 55 & later 235ci & 261ci engines (\$100 core). 1.069 -0  
 ..... **CALL** ⚠



**3741033LP** ..... **.29-54**  
 For doing a 235ci conversion in earlier chevys. Includes gasket for '55 & later 235ci & 261ci 6-cylinders. 1.069 -0.2  
 ..... **\$140.00 EA** ⚠



**598308** ..... **.37-38**  
 W/ gasket (\$150 core). 1.069 -0.2  
 ..... **\$225.50 EA** ⚠



**838903** ..... **.39-40**  
 W/ gasket (\$150 core). 1.069 -0.2  
 ..... **\$225.50 EA** ⚠



**939467** ..... **.41-52**  
 W/ gasket (\$75 core). 1.069 -0.2  
 ..... **\$195.75 EA** ⚠



**Water Pump, cont.**

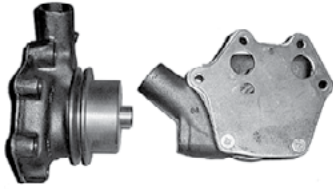

**3836804** .....**53-54**  
W/ gasket (narrow pulley). \$75.00 core charge. 1.069 -0.15 ..... **\$148.00 EA** ⚠

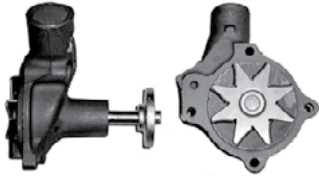

**3774212**.....**54-55**  
Fits 261ci. W/ Gasket 1.069 -0.15 ..... **\$92.75 EA** ⚠



**WPADAPT**.....**ALL**  
Water Pump Adapter Plate For 55 & Up 235, 261 Engines To Use Earlier 41-54 Water Pumps 1.069 -0.2 ..... **\$50.00 EA** ⚠

**Water Pump Rebuild Service**

**REBUILDWP**.....**ALL**  
Rebuild service for your water pump. -0.15

..... starting at **\$179.00 EA** ⚠

**Water Pump Backing Plate**



**838151**.....**37-40**  
Metal backing plate behind the water pump 1.113 -0.15 ..... **\$32.75 EA** ⚠

**Backing Plate Gasket (Water Pump)**



**383150**.....**37-40**  
Backing plate gasket 1.114 -0.15 ..... **\$4.00 EA** ⚠



**839469**.....**41-54**  
Backing plate gasket 1.114 -0.3 ..... **\$5.75 EA** ⚠

**Water Pump to Block Gasket**



**838137**.....**37-40**  
Water pump to block 1.079 -0.2 ..... **\$5.75 EA** ⚠



**3836048**.....**41-54**  
Water pump to block 1.079 -0.15 ..... **\$4.75 EA** ⚠



**3836162**.....**55-61**  
Water pump to block. For water pump w/ short pulley & shaft (part # 3741033 55 & later 235ci & 261ci engines) 1.069 -0.15

..... **\$4.25 EA** ⚠

**Pulley Water Pump**



**3836804A**.....**53-54**  
Cast Iron 1.069 -0.2 ..... **\$37.50 EA** ⚠

**Fan**



**838277**.....**37-54**  
Black finish fan blade. Fits 37-40 GA, HA, KH & 41-54 Passenger. 1.064 -0.15 ..... **\$32.25 EA** ⚠

**Belt**



**3680776**.....**37-52**  
For fan & generator 1.066 -0.15 ..... **\$18.50 EA** ⚠



**2190650**.....**39-53**  
For fan & generator. Fits GMC. 8.033 -0.2 ..... **\$7.50 EA** ⚠



**3713313**.....**53-54**  
For fan & generator 1.066 -0.15 ..... **\$7.00 EA** ⚠



**2304817**.....**54**  
For fan & generator. Fits GMC. 1.066 -0.2 ..... **\$9.00 EA** ⚠

**Thermostat Housing**



**839232B**.....**40-57**  
Lower thermostat housing / water neck, all 6 cyl. 1.251 -0.15 ..... **\$50.25 EA** ⚠



**839232T**.....**40-57**  
Upper thermostat housing / water neck, all 6 cyl. 1.251 -0.15 ..... **\$49.50 EA** ⚠



**OTB-6413**.....**ALL**  
1/2" aluminum thermostat housing spacer. Used to space thermostat housing

away from aftermarket valve covers. Includes mounting hardware. Fits 216ci, 235ci, 261ci -0

..... **\$39.25 EA** ⚠

**Thermostat**



**3123995**.....**29-54**  
180 degree. 1.246 -0.3

..... **\$12.00 EA** ⚠



**3133598**.....**29-54**  
160 degree. 1.246 -0.2

..... **\$10.50 EA** ⚠

**Thermostat Housing Gasket**



**838341**.....**37-57**  
Thermostat housing gasket. Fits gooseneck. 1.154 -0.2

..... **\$1.75 EA** ⚠

**Head To Water Outlet Gasket**



**3838297**.....**37-62**  
Head to water outlet 1.252 -0.15

..... **\$2.25 EA** ⚠

**Bushing**



**3837160**.....**38-62**  
For temp gauge. 3/8" I.D. 1/2" NPT O.D. 1.150 -0.15

..... **\$9.75 EA** ⚠

**Petcock In Engine Block**

**120842**.....**ALL**  
1/8" NPT Fits Engine Block 8.951 -0 ..... **\$4.99 EA** ⚠



**WARNING:** Cancer and Reproductive Harm — www.P65Warnings.ca.gov

Chemicals shipped domestic ground only (Lower 48 states only). No international shipping.

**Phone: (360) 816-0211 • (800) 999-CHEV (2438) • www.chevsofthe40s.com**

**OLD AIR — Air Conditioning & Heating System — GREAT FOR 6-CYLINDER APPLICATIONS!**

**Complete Universal systems with everything you need to install Heat & Air Conditioning in your vehicle (minus refrigerant).** These Hurricane units are designed for efficiency and minimal use of space to allow for stereos, glove boxes, wiper motors, etc. Choose Hurricane unit with Upper, Lower or Side exit fittings (see dimensions below). System includes Sanden 508 Compressor (or equivalent), mounting brackets, Condenser (you'll need to measure your radiator), Receiver/ Drier, Binary Pressure Safety Switch, A/C & Heater Hose, Wire Harness, Clamps, 4 inch Vent Hose Kit, Control Panel w/ Knobs and more. Pick 4 vents to best suit your dash (some double vents count as 2). Optional items include Electronic Slide Controls (Vertical or Horizontal) in black or aluminum finish, Chrome Drier or Polished Compressor.



Condensers use flat tubes not round creating greater frontal area which equates to improved cooling.

The Heat & Defrost units for these systems mounts directly to your firewall. A/C & Heater lines pass through a custom rubber grommet that fits into the factory blower motor hole (shown below). Take a look at our In-Dash Vent and Switch kit below. These systems are designed for easy installation with custom condenser mounting, aluminum lines and step-by-step instructions. Retains cowl vent and majority of glove box. Has floor Heat and De-Humidified Defrost.



**UNIVERSAL FOR MOST APPLICATIONS**

A little tight on defroster space for your HVAC unit? Just let your sales rep know that you want the 90 degree defroster outlet option. And hey, we won't even charge you for it.

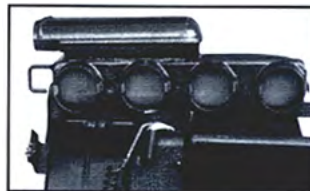

90° Defrost Option  
Requires only 1-7/8" space above for duct hose routing, includes "Y" adapter.



Standard Defrost Outlets  
Allow 2-1/2" to 3" above for duct hose routing



**SECTION 035T  
STREET ROD PARTS**

**Air Conditioning & Heating System**



**AC4000DC** ..... **47-54**  
Cable operated controls. 9.779 -0.15  
**\$1,350.50 SET** ⚠️



**AC4100DC** ..... **47-54**  
Complete system. Mounts under dash.  
Electronic Controls. 9.779 -0.15  
**\$1,450.50 SET** ⚠️



**AC1000C** ..... **ALL**  
Complete System with  
Upper HVAC fittings  
and Cable Controls.  
9.779 -0.15  
**\$1,125.00 SET** ⚠️

**AC1100C** ..... **ALL**  
Complete System with Upper HVAC fittings  
and Electronic Controls. 9.779 -0.15  
**\$1,227.75 SET** ⚠️

**AC2000C** ..... **ALL**  
Complete System with 90-degree HVAC  
fittings and Cable Controls. 9.779 -0.15  
**\$1,125.00 SET** ⚠️

**AC2100C** ..... **ALL**  
Complete System with right side HVAC  
fittings and Electronic Controls. 9.779 -0.15  
**\$1,328.50 SET** ⚠️

**AC3000C** ..... **ALL**  
Complete System with Lower HVAC fittings  
and Cable Controls. 9.779 -0.15  
**\$1,127.00 SET** ⚠️

**AC3100C** ..... **ALL**  
Complete System with Lower HVAC fittings  
and Electronic Controls. 9.779 -0.15  
**\$1,219.00 SET** ⚠️

**Air Conditioning & Heating System  
-Radio Speaker Grille**



**AC4000GC** ..... **47-53**  
Complete system. Cable operated controls.  
Choose 2 additional vents. 9.779 -0.15  
**\$1,355.25 SET** ⚠️

**AC4000GI** ..... **47-53**  
Interior only system. Cable operated  
controls. Choose 2 additional vents (no  
A/C items forward of firewall: compressor,  
dryer, etc). 9.779 -0.15  
**\$720.00 SET** ⚠️

**Air Conditioning System Vents  
Double Units**

**VENT-20** ..... **ALL**  
HVAC vents under dash,  
rectangular double vent  
(2" x 10" ), Counts as 2. 9.779 -0.15  
**\$24.75 EA** ⚠️

**VENT-3** ..... **ALL**  
HVAC vents under dash,  
rectangular double vent  
(2" x 11-1/2" ). Counts as 2. 9.779 -0.15  
**\$27.50 EA** ⚠️

**Air Conditioning System Vents  
Single Units**

**VENT-1** ..... **ALL**  
HVAC vent under dash,  
rectangular (2" x 6-1/4"  
). 9.779 -0.15  
**\$14.50 EA** ⚠️

**VENT-10** ..... **ALL**  
HVAC vents under dash,  
round corner. 9.779 -0.15  
**\$34.50 PR** ⚠️

**VENT-14** ..... **ALL**  
HVAC vents kick panel  
louvers (pair). 9.779 -0.15  
**\$34.50 EA** ⚠️

**VENT-2** ..... **ALL**  
HVAC vents under dash,  
round (3" x 4-1/2" ).  
9.779 -0.15  
**\$15.50 EA** ⚠️

**VENT-21** ..... **ALL**  
HVAC vents in dash,  
rectangular (3-1/2" x  
3-1/2" ). 9.779 -0.15  
**\$17.50 EA** ⚠️

**Air Conditioning System Vents  
Single Units, cont.**

**VENT-5** ..... **ALL**  
HVAC vents in dash,  
rectangular (1-3/8" x  
4-3/4" ). 9.779 -0.15  
**\$14.00 EA** ⚠️

**VENT-6** ..... **ALL**  
HVAC vents in dash,  
rectangular (1-3/8" x  
3-3/4" ). 9.779 -0.15  
**\$14.00 EA** ⚠️

**VENT-7** ..... **ALL**  
HVAC vents in dash,  
rectangular (2-3/4" x  
2-1/2" ). 9.779 -0.15  
**\$14.00 EA** ⚠️

**VENT-8** ..... **ALL**  
HVAC vents in dash,  
rectangular (2" x 5-1/4"  
). 9.779 -0.15  
**\$14.75 EA** ⚠️

**Air Conditioning & Heating System  
Upgrade**

**ACDRIERUP** ..... **ALL**  
Chrome drier for air  
conditioning. With  
polished mounting  
bracket. 8" L x 2-1/2"  
dia. With sight glass. 9.779 -0.15  
**\$78.00 EA** ⚠️

**ACDVENT** ..... **ALL**  
Defroster vent.  
Replaces missing or  
worn vents. Plastic.  
9.779 -0.15  
**\$18.50 EA** ⚠️



**ACPNL-E** ..... **ALL**  
Electronic controls. Smooth servo action.  
Available in Horizontal or Vertical cover  
plate and Brushed Aluminum or Black  
finish. 9.779 -0 ..... **starting at \$85.00 EA** ⚠️

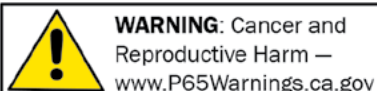

Chemicals shipped domestic ground only (Lower 48 states only). No international shipping.

**Phone: (360) 816-0211 • (800) 999-CHEV (2438) • www.chevsofthe40s.com**

**Universal Heater / Defroster**



**506101.....ALL**  
GEN II COMPAC heater / defroster with electronic servo controls & 3 speed fan.  
9.779 -0.15 ..... **\$308.25 KIT** ⚠

**Universal Heater**



**50515-VUH.....ALL**  
GEN II COMPAC heater only with electronic servo controls & 3 speed fan. 9.779 -0.15  
..... **\$244.75 EA** ⚠

**SECTION 035T  
RESTORATION PARTS**

**Fan**



**40848.....ALL**  
12 volt 6" steel blade heavy duty fan. -0.15  
..... **\$38.00 EA** ⚠

**Heater Paint**



**604481P....42-46**  
Heater beige hammertone (thin w/ enamel thinner).  
16.080 -0  
..... **CALL** ⚠

**Heater Decal**



**DEC07.....47-52**  
Chevrolet round emblem. 19.200 -0.15  
**\$26.25 EA** ⚠



**DEC08.....47-52**  
GMC round emblem. 19.200 -0.15  
**\$30.00 EA** ⚠



**DEC29.....49-51**  
Decal-Harrison 19.200 -0.15 ..... **\$9.00 EA**  
⚠



**DEC09.....53**  
Fresh air round decal. 19.200 -0.15  
**\$6.00 EA** ⚠



**DEC17.....53**  
Recirculating round decal. 19.200 -0.15  
..... **\$3.75 EA** ⚠



**DEC10.....53-54**  
GMC round decal. 19.200 -0.15  
**\$4.75 EA** ⚠

**Heater Decal, cont.**



**DEC16.....54-55**  
Fresh air round decal. 19.200 -0.15  
**\$6.00 EA** ⚠



**DEC18.....54-55**  
Recirculating round decal. 19.200 -0.15  
..... **\$5.25 EA** ⚠

**Defroster Decal**



**DEC06.....47-55**  
On/off defroster decal. 19.200 -0.15  
**\$3.00 EA** ⚠

**Heater Box**



**986248.....47-54**  
Heater Box Deluxe 8.854 -0.15  
**\$153.00 EA** ⚠

**Heater Gasket**

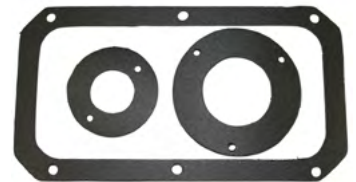

**986248A.....47-54**  
Gasket, deluxe heater set. 8.845 -0.15  
**\$13.25 EA** ⚠





**Heater Core**



**3115847** ..... **41-46**  
 Harrison Deluxe Heater Core New  
 8.854 -0.15 ..... **\$299.25 EA** ⚠️



**3119687** ..... **47-52**  
 Fresh air heater core, Airflow heater only  
 8.854 -0.15 ..... **\$190.50 EA** ⚠️



**3119687A** ..... **47-52**  
 Fresh air heater core, Airflow heater only.  
 Superior made in USA. 8.854 -0.15 .....  
**\$330.00 EA** ⚠️



**986104** ..... **47-54**  
 Replacement for Harrison round heater  
 core. 8.854 -0.15 ..... **\$299.25 EA** ⚠️

**Heater Core Rebuild**

**3115605R** ..... **37-54**  
 Rebuild your heater core 8.854 -0.15  
 ..... **CALL** ⚠️

**Heater Control Brackets**



**3119687B** ..... **47-55**  
 For Fresh Air  
 Heater -0.15  
 ..... **\$21.50 EA** ⚠️

**Heater Control Valve**

**3128267D** ..... **47-55**  
 Heater control valve rebuild service using  
 your core. 8.861 -0.15  
 ..... **\$110.00 EA** ⚠️

**Heater Control Valve Rebuild Kit**



**3128267C** ..... **47-54**  
 Heater control  
 valve rebuild kit, w/  
 instructions. 8.861 -0.15

..... **\$17.00 EA** ⚠️

**Heater & Defroster Shutoff Valve**



**985533** ..... **35-54**  
 Heater shutoff valve replacement, screws  
 into water pump. For 5/8" hose. 8.870 -0.15  
 ..... **\$45.00 EA** ⚠️

**Heater & Defroster Nipple**



**3106066** ..... **29-54**  
 Heater/Defroster Nipple  
 connects heater hose to  
 engine. 8.866 -0.2

..... **\$18.00 EA** ⚠️

**Heater Motor**



**5047730** ..... **47-54**  
 Heater Motor. 6v exc  
 airflow (5-1/2 in. x  
 2-7/8 in. diameter),

NOS. 8.855 -0

..... **CALL** ⚠️

**Heater & Defroster Motor**



**5047531** ..... **37-54**  
 Heater/Defroster motor 6v replacement (5  
 in. x 2-3/4 in. diameter) 1-3/8 in. shaft,  
 reversible. 8.855 -0.15 .. **\$55.50 EA** ⚠️



**5047849** ..... **37-54**  
 Heater/Defroster motor 12v replacement,  
 (5 in. x 2-7/8 in. diameter) 1-1/2 in. shaft,  
 reversible. 8.855 -0.15 .. **\$57.25 EA** ⚠️

**Heater Wiring Harness**



**3106048B**... **37-49**  
 Heater & defroster  
 wiring harness  
 8.853 -0.15  
 ..... **\$66.00 EA** ⚠️

**Resistor**



**3829052** ..... **38-72**  
 Heater blower motor (w/o A/C).  
 Note: Replaces GM #3929052  
 Replaces AC Delco #15-80836 8.855 -0.15  
 ..... **\$19.25 EA** ⚠️

**Heater Switch**



**3112682B**... **ALL**  
 Heater switch 6v,  
 rotary rheostat,  
 clamps to dash  
 bottom.  
 Variable speed.  
 8.852 -0.15  
 ..... **\$19.50 EA** ⚠️



**3112682C**... **ALL**  
 Heater switch 12v,  
 rotary rheostat,  
 clamps to dash  
 bottom.  
 3 speed. 8.852 -0.2  
 ..... **\$22.50 EA** ⚠️

**Heater & Defroster Knob**



**3129274C** ..... **47-53**  
 Heater/Defroster  
 knob warmer, maroon.  
 Original color and  
 quality. 8.861 -0

..... **CALL** ⚠️



**3129274D** ..... **54**  
 Heater/Defroster knob  
 warmer, black. Original  
 color and quality.  
 8.861 -0.4

..... **\$14.00 EA** ⚠️

**Cowl Vent Knob**



**3656663A** ..... **40-46**  
 As original, brown.  
 16.130 -0.15  
 ..... **\$8.75 EA** ⚠️



Chemicals shipped domestic ground only (Lower 48 states only). No international shipping.

Phone: (360) 816-0211 • (800) 999-CHEV (2438) • www.chevsofthe40s.com

**Cowl Vent Knob, cont.**



**985603** .....40-46  
Ivory accessory 9.691 -0

..... **\$15.00 EA** ⚠



**3682916A** .....47-53  
Side or top vent,  
maroon. 16.130 -0.15

..... **\$7.00 EA** ⚠



**3131111** ..... 54  
Black. Original color  
and quality. 16.130 -0.4

..... **\$14.00 EA** ⚠

**Defroster Duct Hose**



**3119156R** .....**ALL**

Defroster duct hose 1-1/2 in. i.d. 36 in.  
length. Plastic replacement (original was  
cloth covered, wound wire) 9.779 -0

..... **\$25.00 EA** ⚠

**3119719** ..... **ALL**

Defroster duct hose 1-3/4 in. i.d. 36 in.  
length. Cloth covered. 9.779 -0.15

..... **\$22.00 EA** ⚠

**3125764** ..... **ALL**

Defroster duct hose 2 in. i.d. 36 in.  
length. Cloth covered. 9.779 -0.15

..... **\$24.00 EA** ⚠

**Heater & Defroster Hose**



**3691292** .....**ALL**

Heater Hose Black, 5/8" I.D., 7/8" O.D.  
hose 8.846 -0.3

..... **\$2.25 FT** ⚠

**Heater & Defroster Hose Clamps**



**432645** .....**ALL**

Heater Hose Clamps  
Fits 5/8" I.D. hose.  
Original (4 pcs)  
1.166 -0.2

..... **\$5.00 SET** ⚠

**Aluminum Bundle Straps**



**13196** .....**ALL**

.25" W X 4.05" L  
Used to bundle wires or hoses. -0.2  
**\$4.00 EA** ⚠



**13197** .....**ALL**

.25" W X 7.15" L  
Used to bundle wires or hoses -0.2  
**\$5.00 EA** ⚠

**Heater Grommet**

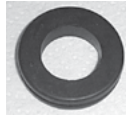

**3691292A** .....47-54

Grommet for 5/8 in.  
heater hose (thru  
firewall). 8.846 -0

..... **\$6.25 PR** ⚠



**1951 Panel — Pierre Moberg**



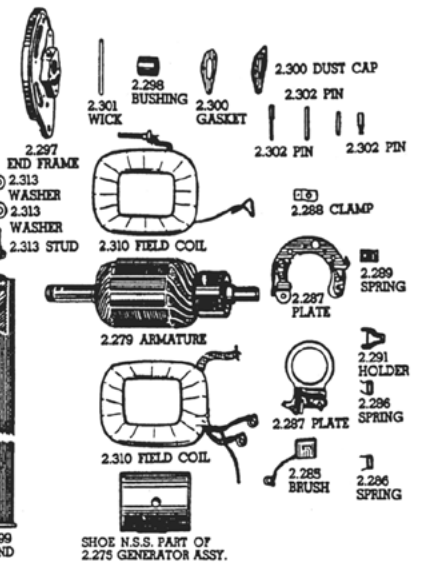
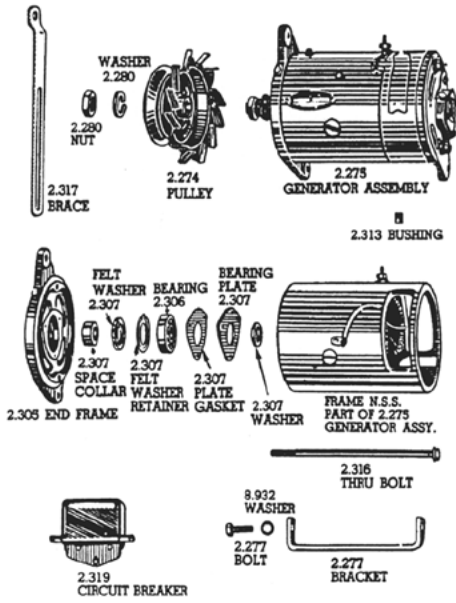
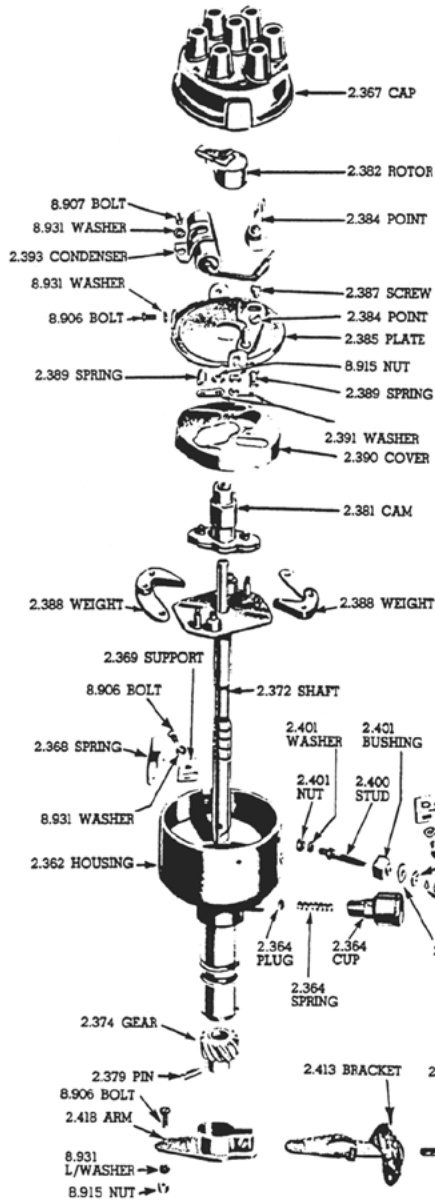

**GENERATOR**

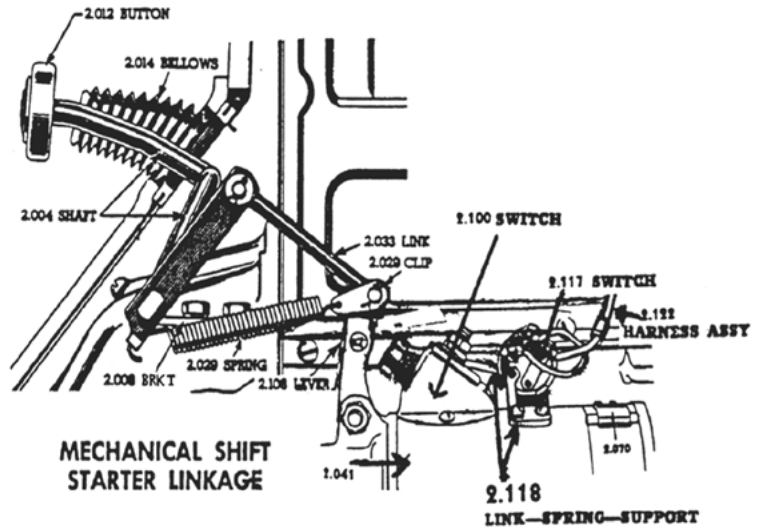

**MECHANICAL SHIFT STARTER LINKAGE**

**2.118 LINK-SPRING-SUPPORT**

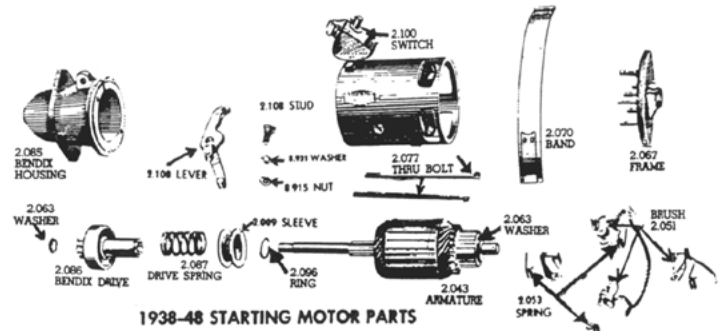
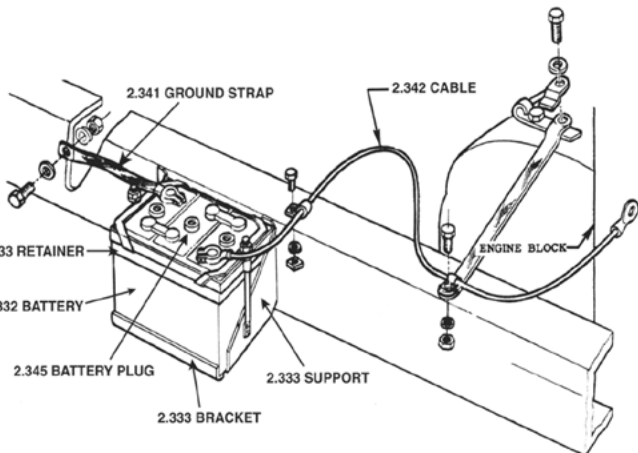

**1938-48 STARTING MOTOR PARTS**



**WARNING:** Cancer and Reproductive Harm — www.P65Warnings.ca.gov

Chemicals shipped domestic ground only (Lower 48 states only). No international shipping.

**Phone: (360) 816-0211 • (800) 999-CHEV (2438) • www.chevsofthe40s.com**

**SECTION 040T  
RESTORATION PARTS**

**Engine Crank**



**3661378** ..... **37-53**  
Manual start, hardened steel. Repro.  
0.239 -0.15 ..... **\$68.50 EA** ⚠



**3681380** ..... **47-53**  
Starting crank support  
bracket 7.025 -0.15  
..... **\$23.50 EA** ⚠

**Starter**



**1107108** ..... **38-54**  
Rebuilt 6 volt foot operated (\$50 core)  
2.041 -0 ..... **\$185.00 EA** ⚠

**1107108C** ..... **38-54**  
Rebuilt 12 volt foot operated (\$50 core)  
2.041 -0 ..... **\$250.00 EA** ⚠



**1913369** ..... **49-54**  
Rebuilt 6 volt. Uses solenoid (\$100 core).  
Fits Passenger & DUBL-DUTI Trucks.  
2.041 -0.15 ..... **\$184.50 EA** ⚠

**1913369C** ..... **49-54**  
Rebuilt 12 volt. Uses solenoid (\$100 core).  
Fits Passenger & DUBL-DUTI Trucks.  
2.041 -0 ..... **\$249.75 EA** ⚠



**1913369GR** ..... **ALL**  
High torque gear reduction starter. Built in  
solenoid 12v, fits 139 tooth Flywheel. Has  
multiple mounting positions. -0.15 ..  
**\$329.75 EA** ⚠

**Starter Rebuild Service**

**1864489** ..... **37-54**  
Rebuild yours 2.041 -0.15  
..... **\$185.00 EA** ⚠

**Starter Rebuild Kit**



**1900558** ..... **37-54**  
W/ brushes, springs, bushing (29 pcs).  
2.053 -0.1 ..... **\$75.00 KIT** ⚠

**Starter Drive**



**1859020** ..... **34-37**  
Starter drive assembly 2.086 -0.15  
..... **\$89.99 EA** ⚠



**2873789** ..... **38-54**  
Starter drive assembly  
2.086 -0.15 ..... **\$24.50 EA** ⚠

**Starter Brush Set**



**811553** ..... **25-54**  
This is a starter brush  
set for 1925-54.  
2.051 -0.3 ..... **\$5.00 SET** ⚠

**Starter Bushing**



**810620** ..... **29-37**  
Drive end 2.083 -0.4  
..... **\$7.75 EA** ⚠



**1839345** ..... **38-54**  
Drive end 2.083 -0.4  
..... **\$3.00 EA** ⚠



**810620A** ..... **38-54**  
Non-drive end 2.083 -0  
..... **\$4.25 EA** ⚠

**Starter Band**



**817114** ..... **29-54**  
Covers openings on starter. 2.070 -0.4  
..... **\$9.50 EA** ⚠

**Starter Oil Cover**



**114998** ..... **29-54**  
Hinged lid. 5/16 in.  
o.d. insert. 2.305 -0.15  
..... **\$12.75 EA** ⚠

**Starter Switch**



**WKS1** ..... **37-54**  
Electric switch kit when  
switching from foot  
operated starter (part #  
1913369GR) -0.15  
..... **\$45.00 EA** ⚠



**820052A** ..... **38-54**  
Foot starter. No side  
terminal. 2.100 -0.2  
..... **\$13.50 EA** ⚠

**Starter Solenoid**



**1118135** ..... **54**  
Double Duty & 54-55  
Hydromatic (solenoid  
only) 2.100 -0  
..... **\$80.00 EA** ⚠

**Starter Solenoid Repair Kit**



**1118135A** ..... **54-55**  
Double Duty & 54-55  
Hydromatic 2.100 -0.15  
..... **\$25.00 EA** ⚠

**Starter Solenoid Boot**



**1912448** ..... **49-59**  
Double duty model and  
hydromatic 2.113 -0  
..... **\$7.50 EA** ⚠

**Insulator**



**1118135C** ..... **49-64**  
Molded, keeps solenoid  
cool. 2.100 -0.15  
..... **\$16.75 EA** ⚠



**Polarity Reverse Switch**



**1889827 . . . .41-42**  
On starter, w/ 1 in. x  
1-1/2 in. base (NOS)  
2.117 -0.4

..... **\$55.00 EA** ⚠



**1907122 . . . .46-48**  
On starter (NOS)  
2.117 -0.4

..... **\$44.00 EA** ⚠

**Polarity Reverse Switch Wiring Harness**



**1881929 . . . .41-48**  
Wiring harness for  
reverse polarity  
switch. 2.122 -0.15

..... **\$35.00 EA** ⚠

**Starter Pedal Return Spring**



**3654152 . . . .37-54**  
Return spring. 2.029 -0

..... **\$3.99 EA** ⚠

**Delco Remy Metal Tag**



**PLATE07 . . . . .37**  
Generator, starter & distributor 19.400 -0.15

..... **\$7.00 EA** ⚠



**PLATE05 . . . . .38-54**  
Generator, Starter or Distributor. Includes  
rivets. 19.400 -0.15

..... **\$7.00 EA** ⚠

**Odds & Ends**

Please call for availability on all Odds & Ends parts; once part is sold, it may no longer be in stock.

**813550 . . . . .25-37**  
Commutator end frame 25-37 Chevy. 26-29, 33-34 Pontiac 2.067 -0.4

..... **\$15.00 EA** ⚠

**1848532 . . . . .34-37**  
Spring Starter Motor 3.000 -0.4

..... **\$10.00 EA** ⚠

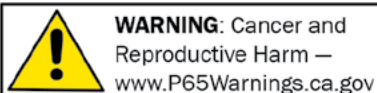

**SECTION 045T  
STREET ROD PARTS**

**12 Volt Conversion Kits**

**12VKIT01...37-54**  
Includes 63 amp alternator with 5/8" pulley, bracket & hardware, 10 AWG charge wire, coil, horn relay, headlight relay, fuel gauge voltage reducer, instructions. -0.15

**12VKIT02...37-54**  
Includes 63 amp alternator with 3/8" pulley, bracket & hardware, 10 AWG charge wire, coil, horn relay, headlight relay, fuel gauge voltage reducer, instructions. -0.15

**12VKIT03...37-54**  
Includes 100 amp alternator with 5/8" pulley, bracket & hardware, 10 AWG charge wire, coil, horn relay, headlight relay, fuel gauge voltage reducer, instructions. -0.15

**12VKIT04...37-54**  
Includes 100 amp alternator with 3/8" pulley, bracket & hardware, 10 AWG charge wire, coil, horn relay, headlight relay, fuel gauge voltage reducer, instructions. -0.15

**12VKIT05...37-54**  
Includes 63 amp alternator with 5/8" pulley, bracket & hardware, 10 AWG charge wire, coil, starter solenoid, horn relay, headlight relay, fuel gauge voltage reducer, instructions. -0.15

**12 Volt Conversion Kits, cont.**

**12VKIT06...37-54**  
Includes 63 amp alternator with 3/8" pulley, bracket & hardware, 10 AWG charge wire, coil, starter solenoid, horn relay, headlight relay, fuel gauge voltage reducer, instructions. -0.15

**12VKIT07...37-54**  
Includes 100 amp alternator with 5/8" pulley, bracket & hardware, 10 AWG charge wire, coil, starter solenoid, horn relay, headlight relay, fuel gauge voltage reducer, instructions. -0.15

**12VKIT08...37-54**  
Includes 100 amp alternator with 3/8" pulley, bracket & hardware, 10 AWG charge wire, coil, starter solenoid, horn relay, headlight relay, fuel gauge voltage reducer, instructions. -0.15

**PowerGen**

Keep the original look of your generator with all the benefits of an alternator. 1-wire hookup. Easy to install. Internal regulator. Huge amp increase stops dimming headlights. Made from billet aluminum and for half the weight. Durable black powdercoat finish.

**82051...ALL**  
Powermaster-PowerGen GM Long (90A,12V) Black -0.15

**82057...ALL**  
Powermaster-PowerGen GM Long (60A,6V Neg Ground) Black -0.15

**82111...ALL**  
Powermaster-PowerGen GM Short (90A,12v) Black 2.275 -0.15

**82117...ALL**  
Powermaster-PowerGen GM Short (60A,6V Neg Ground ) Black -0.15

**Alternator**

**89502C...ALL**  
6v-60 amp, 7.5v show chrome housing, 3/8" 2 groove pulley, internally regulated, comes w/ D.A. plug, uses original wiring, new. 2.275 -0

**89502S...ALL**  
6v-60 amp, 7.5v internally regulated, single groove 3/8" pulley. †(Rebuilt) 2.275 -0.15

**905021...ALL**  
10SI 12v, 63 Amp Internally Regulated With 3/8 "Pulley -0.15

**905022...ALL**  
CS130 12v, 100 Amp Internally Regulated With 3/8 "Pulley -0.15

**905023...ALL**  
10SI 12v 63 amp, Chrome Internally Regulated 1-Wire With 3/8 "Pulley -0.15

**905024...ALL**  
10SI 12v 100 amp, Chrome Internally Regulated 1-Wire With 5/8 "Pulley -0.15

**90502S...ALL**  
12v-60 amp, 14v internally regulated, simple two wire hookup, replace any 12v generator, comes with D.A. plug, new. 2.275 -0.15

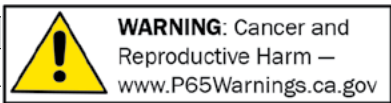

**D.A. Plug**



**89502.....ALL**  
Connects 6v or 12v alternator to original wiring. 2.275 -0.15 ..... **\$20.00 EA** ⚠️

**Alternator Pulley**



**90502WP.....37-52**  
Fits 5/8 in. belt. 2.274 -0.15 ..... **\$40.00 EA** ⚠️



**89502P.....ALL**  
3/8" 2 groove.  
2.274 -0.15  
..... **\$37.50 EA** ⚠️

**Mount Bracket**



**839446B.....37-55**  
Universal alternator bracket. 2.277 -0.15  
..... **\$89.75 EA** ⚠️

**839446D.....37-55**  
Alternator bracket. Mounting hardware included. 2.277 -0.2 ..... **\$76.00 KIT** ⚠️



**3714376B.....55-62**  
Alternator bracket (12v or 6v alt. 55-62 requires narrow pulley pump & 53-up crank pulley). Mounting hardware included. 2.277 -0.2 ..... **\$73.75 EA** ⚠️

**Mount Bracket, cont.**



**3714376B.....55-62**  
Alternator bracket (12v or 6v alt. 55-62 requires narrow pulley pump & 53-up crank pulley). Mounting hardware included. 2.277 -0.2 ..... **\$76.00 EA** ⚠️

**Battery Jump Starter**



**GB40.....ALL**  
Compact, yet powerful 1,000 Amp lithium-ion jump starter that delivers 7,000 Joules of starting power. Its patented safety technology features spark-proof technology and reverse polarity protection making it safe for anyone to use. Designed for use with gas engines up to 6 liters and diesel engines up to 3 liters and doubles as a portable power source for recharging smartphones, tablets and more. -0.15  
..... **\$99.75 EA** ⚠️



**GB70.....ALL**  
The GB70 is a portable lithium-ion battery jump starter pack that delivers 2,000-amps (15,700 J3S) for jump starting a dead battery in seconds. It features a patented safety technology that provides spark-proof connections and reverse polarity protection making safe and easy for anyone to use. It's a powerful battery booster that doubles as a portable power source for recharging USB devices, like a smartphone, tablet and more, or powering 12-volt devices, like a tire inflator, power inverter and much more. And designed for a car, boat, RV, truck and more with gas engines up to 8 liters, and diesel engines up to 6 liters. -0.15 ... **\$199.75 EA** ⚠️

**Genius Battery Chargers**



**G1100.....ALL**  
1.1 Amp UltraSafe Smart Battery Charger

Charge fully drained lead-acid and lithium-ion batteries up to 40 amp-hour with zero overcharge - Stay safely connected 24/7.

Ultimate performance and versatility. Charge 6-volt and 12-volt batteries, recover damaged batteries, suitable for micro-hybrid start-stop vehicles and works with CANBUS electrical systems.

Ultra-compact, portable, energy-efficient design that's impact, UV and water-resistant (IP65).

Actively monitors battery for safe and efficient charging. Includes spark-proof technology and reverse polarity protection.

Advanced diagnostics automatically tests and detects a bad, damaged, or shorted battery. -0.15 .. **\$39.75 EA** ⚠️



**G3500.....ALL**  
3.5 Amp UltraSafe Smart Battery Charger

Charge fully drained lead-acid and lithium-ion batteries up to 120 amp-hour with zero overcharge - Stay safely connected 24/7.

Ultimate performance and versatility. Charge 6-volt and 12-volt batteries, recover damaged batteries, suitable for micro-hybrid start-stop vehicles and works with CANBUS electrical systems.

Ultra-compact, portable, energy-efficient design that's impact, UV and water-resistant (IP65).

Actively monitors battery for safe and efficient charging. Includes spark-proof technology and reverse polarity protection.

Advanced diagnostics automatically tests and detects a bad, damaged, or shorted battery. -0.15 .. **\$56.00 EA** ⚠️



Chemicals shipped domestic ground only (Lower 48 states only). No international shipping.

**Phone: (360) 816-0211 • (800) 999-CHEV (2438) • www.chevsofthe40s.com**

**SECTION 045T  
RESTORATION PARTS**

**Generator**



**1102744** .....**40-52**  
Rebuilt 10-1/2 in. long, 6v (\$75 core) -  
5/8 in. belt pulley. To determine your  
generator size measure all the way to end  
of pulley. 2.275 -0.15 ... **\$194.75 EA** ⚠



**1100024** .....**52-54**  
Rebuilt 9-1/2 in. long, 6v (\$75 core).  
Narrow belt pulley. To determine your  
generator size measure all the way to the  
end of pulley. 2.275 -0.15 ... **\$194.75 EA**  
⚠

**Generator Rebuild Service**

**1100502** .....**29-54**  
Rebuild service for your generator  
2.275 -0.15  
..... **\$195.00 EA** ⚠

**Generator Rebuild Kit**



**597667** .....**35-52**  
Pulley 2.274 -0.2  
..... **\$39.50 EA** ⚠



**1901243** .....**40-54**  
W/ brushes, gaskets, etc. (41 pcs).  
Pulley end bearing #954378 not included.  
2.286 -0 ..... **CALL** ⚠

**Generator Brush Set**



**1857963** .....**37-39**  
3 pieces 2.285 -0.2 ..... **\$9.75 SET** ⚠



**1878209** .....**40-54**  
2 pieces 2.285 -0.3 ..... **\$9.25 SET** ⚠

**Generator Bearing**



**954378** .....**29-57**  
Pulley end 2.306 -0.2  
..... **\$7.50 EA** ⚠



**954685** .....**53-57**  
Commutator end  
2.298 -0.15  
..... **\$12.00 EA** ⚠

**Generator Bushing**



**812823** .....**29-48**  
Commutator end  
2.298 -0.4  
..... **\$4.00 EA** ⚠



**812824** .....**49-52**  
Commutator end  
2.298 -0.4  
..... **\$3.29 EA** ⚠

**Generator Oil Cover**



**816341** .....**29-54**  
Metal, as original. 3/16  
in. o.d. insert 2.305 -0.15  
..... **\$6.00 EA** ⚠

**Generator Band**



**816340** .....**29-52**  
Covers opening in generator. 2.299 -0.3  
**\$8.50 EA** ⚠

**Generator Bolt & Nut**



**3682642B** .....**37-54**  
Set (generator to motor)  
2.277 -0.15  
..... **\$5.25 SET** ⚠

**Delco Remy Metal Tag**



**PLATE07** ..... **37**  
Generator, starter & distributor 19.400 -0.15  
..... **\$7.00 EA** ⚠



**PLATE05** .....**38-54**  
Generator, Starter or Distributor. Includes  
rivets. 19.400 -0.15 .... **\$7.00 EA** ⚠

**Belt**



**3680776** .....**37-52**  
For fan & generator  
1.066 -0.15  
..... **\$18.50 EA** ⚠

**2190650** ..... **39-53**  
For fan & generator. Fits GMC. 8.033 -0.2  
..... **\$7.50 EA** ⚠

**3713313** ..... **53-54**  
For fan & generator 1.066 -0.15  
..... **\$7.00 EA** ⚠

**2304817** ..... **54**  
For fan & generator. Fits GMC. 1.066 -0.2  
..... **\$9.00 EA** ⚠

**Voltage Cut Out**



**1867781** .....**29-39**  
Car and truck except COE 2.319 -0.3  
**\$78.75 EA** ⚠





# Section 045T: Alternators, Generators, Voltage Regulators, Batteries, Battery Trays & Battery Cables

## Voltage Regulator

**1118301A** .....40-52  
35 Amp 6 Volt 2.500 -0.15 **\$119.25 EA**



**1118331** .....53-54  
45 Amp 6 Volt 2.500 -0.15 **\$69.75 EA**



## Battery Tray



**594062** .....37-46  
Metal tray only. 2.333 -0.2 **\$48.50 EA**



**594062A** .....37-46  
Metal tray w/ attaching brackets.  
2.333 -0.15 **\$74.50 EA**



**3683563** .....47-54  
Base only. 2.333 -0.15 **\$16.00 EA**



**3683559** .....47-55  
Complete with sides and studs. 2.333 -0.15  
**\$64.75 EA**



## Battery Hold Down



**3653224** .....47-54  
9 1/4" x 7 1/2" battery size 2.335 -0.15  
**\$17.25 EA**



**3653224A** .....ALL  
Adjustable for 9-3/16" X 7-3/16", 10-3/4"  
X 7-3/16" batteries -0.3 **\$16.25 EA**



## Battery Cover



**354120** .....29-38  
Inspection cover in floor. 4-1/2" x 8"  
16.547 -0.15 **\$19.75 EA**



**3652966** .....39-46  
Inspection cover in floor. 4-1/2" x 10".  
16.547 -0.15 **\$25.00 EA**

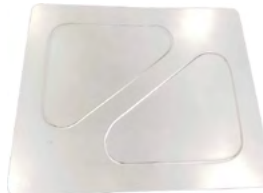

**4754BD** .....47-53  
Battery access delete panel. -0  
**\$40.00 EA**



**3683383** .....47-54  
Mounts in floor.  
16.547 -0.15 **\$64.00 EA**



## Battery Mat



**3686708B** .....ALL  
Anti-corrosion pad to protect your battery  
tray. 7 3/4" X 12" x 1/8" thick. 2.333 -0.3  
**\$15.25 EA**



## Battery Cover Gasket



**3683383A** .....47-54  
Battery inspection cover. 16.547 -0.15  
**\$6.00 EA**



## Battery Tray Paint



**12998** .....ALL  
Battery tray  
Corrosion resistant,  
black (12 oz spray).  
8.800 -0.15  
**\$10.25 EA**



## Ground Strap



**529404A** .....29-54  
13in. 2.341 -0.15 **\$17.00 EA**



**529404N** .....29-54  
13in. NOS 2.341 -0 **\$25.00 EA**

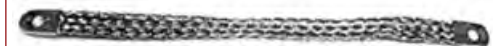

**602387** .....47-54  
13in. Engine to frame. 9.650 -0.15  
**\$12.00 EA**

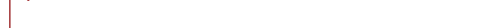

**WARNING:** Cancer and  
Reproductive Harm —  
www.P65Warnings.ca.gov

Chemicals shipped domestic ground only (Lower 48 states only). No international shipping.

Phone: (360) 816-0211 • (800) 999-CHEV (2438) • www.chevsofthe40s.com

045T

# Section 045T: Alternators, Generators, Voltage Regulators, Batteries, Battery Trays & Battery Cables

## Positive Cable



**1854073** .....**29-46**  
Fabric covered 25-1/4 in. 2.342 -0.15  
**\$52.50 EA** ⚠



**5288946** .....**47-54**  
Fabric covered 39-1/2 in. 1/0 Wire.  
1947-54 and 1955 1st Series Trucks.  
2.342 -0.15 ..... **\$57.00 EA** ⚠

## Battery Terminal Cleaner



**10653CLNR** ...**ALL**  
For Top Post  
Batteries. -0.15  
..... **\$9.25 EA** ⚠

## Odds & Ends

**00940** .....**52-54**  
Battery Filler Cap Accessory. Save A  
Battery 2.332 -0.4  
..... **\$35.00 SET** ⚠  
**00991** ..... **57**  
Generator 12 volt rebuilt 3.000 -0.3  
..... **\$200.00 EA** ⚠



**SECTION 050T  
STREET ROD PARTS**

**Ignition Coil Pertronix 6 Volt**



**PER40001** .....ALL  
6 Volt Chrome. 1.5 Ohm primary  
resistance. 2.384 -0.15 ..... **\$58.75 EA** ⚠



**PER40011** .....ALL  
6 Volt Black. 1.5 Ohm  
primary resistance.  
2.384 -0.15  
..... **\$47.50 EA** ⚠

**Ignition Coil Pertronix 12 Volt**



**PER40501** .....ALL  
12 Volt Chrome.  
3.0 Ohm primary  
resistance. 2.384 -0.15

..... **\$56.25 EA** ⚠



**PER40511** .....ALL  
12 Volt Black. 3.0 Ohm  
primary resistance.  
2.384 -0.15

..... **\$45.75 EA** ⚠

**Ballast Resistor**



**1931614** .....ALL  
For 12v (coil). 2.173 -0.2 ..... **\$13.50 EA** ⚠

**HEI Distributor & Wires**



**PED62720** .....ALL  
Chevy 6cyl 1949-62  
216,235,261ci. DUI  
electronic Distributor  
50,000 volt coil &  
Dyna-Module allows  
wider plug gaps  
& instant throttle  
response.

Add a set of Livewires to go with your  
electronic distributor. 0.000 -0.15  
..... **\$394.00 EA** ⚠

**HEI Distributor & Wires, cont.**



**PEDC9066-E** .....ALL  
Chevy in-line 6 cyl., Black 0.000 -0.15 .....  
**\$94.75 SET** ⚠

**Wire Looms**



**5298107L** .....ALL  
Chrome. Fits 216ci, 235ci. 0.000 -0.15 .....  
**\$30.75 SET** ⚠

**Pertronix Electronic Ignition System**



**1112362E12** .....40-53  
Chevy 6cyl. 12v. 2.384 -0.15 .....  
**\$148.75 SET** ⚠



**1112362E6** .....40-53  
Chevy 6cyl. 6v. 2.384 -0 .....  
**\$116.25 SET** ⚠



**1112388E12** .....54-62  
Chevy 6cyl. 12v. 2.384 -0.15 .....  
**\$151.50 EA** ⚠

**Pertronix Electronic Ignition System, cont.**



**1112388E6** .....54-62  
Chevy 6cyl. 6v. 2.384 -0.15 .....  
**\$167.25 EA** ⚠

**SECTION 050T  
RESTORATION PARTS**

**Ignition Coil**



**1115380** .....47-54  
6v, Delco (NOS) 2.170 -0 ..... **CALL** ⚠

**1115380A** .....47-54  
6v, replacement 2.170 -0.15 .....  
**\$49.00 EA** ⚠



**1115091** .....47-59  
12v 2.170 -0.15 ..... **\$23.25 EA** ⚠

**Distributor**



**1112362** .....40-53  
Exc 53 powerglide (\$40 core) 2.361 -0.2  
..... **\$175.00 EA** ⚠

**1112358** .....53-57  
Exc 53 stick shift (\$35 core) 2.361 -0.3  
..... **\$140.00 EA** ⚠

**Points**



**1855720.....33-40**  
2-1/8 in. overall length  
2.384 -0.15  
..... **\$12.25 SET** ⚠



**1882391.....41-48**  
With polarity reversing  
switch (1-3/4 in. overall  
length) 2.384 -0.15  
..... **\$15.50 SET** ⚠



**1855720.....48-53**  
All (exc 48 w/ polarity  
reversing switch & 53  
235ci) 2-1/8 in. overall  
length. 2.384 -0.15  
..... **\$12.25 SET** ⚠



**1924571....53-57**  
All (exc 216ci)  
2-3/16 in. overall  
length. 2.384 -0.15  
..... **\$20.75 SET** ⚠

**Condenser**



**1928111.....37-54**  
Ignition 2.393 -0.15  
..... **\$8.00 EA** ⚠

**Hold Down Screw**



**816784.....ALL**  
Condenser & points  
2.387 -0.4  
..... **\$1.50 EA** ⚠

**Rotor**



**820445.....33-52**  
All exc CC, DC & 53  
235ci 2.382 -0.15  
..... **\$8.75 EA** ⚠



**1924245.....53-57**  
All, exc 53 216ci  
2.382 -0.15  
..... **\$9.00 EA** ⚠

**Distributor Cap**



**824735.....33-53**  
Except 53 235ci 2.364 -0.15  
..... **\$15.25 EA**  
⚠

**Distributor Cap, cont.**



**1924248.....53-54**  
With 235ci, 261ci 2.364 -0.15  
..... **\$26.50 EA** ⚠

**Delco Remy Metal Tag**



**PLATE07.....37**  
Generator, starter & distributor 19.400 -0.15  
..... **\$7.00 EA** ⚠



**PLATE05.....38-54**  
Generator, Starter or Distributor. Includes  
rivets. 19.400 -0.15  
..... **\$7.00 EA** ⚠

**Vacuum Advance**

\$10 shipping & handling fee for rebuild  
service.



**1116076R.....37-54**  
Rebuild service (we rebuild your core)  
2.410 -0.15  
..... **\$58.50 EA** ⚠



**1909343A.....39-55**  
W/ bracket & timing  
mark 90 degrees to  
vacuum chamber. exc  
261 2.410 -0.15  
..... **\$38.50 EA** ⚠

**Spark Plug Wires**

**VPW2B.....ALL**  
These are Vintage cloth wrapped black  
spark plug wires with 90 degree spark  
plug boots. -0.15  
..... **\$69.00 SET** ⚠

**Spark Plug Wire Set**



**5298107.....34-54**  
Superb reproduction w/ GM stamped on  
metal ends. Copper core. 2.239 -0.15  
..... **\$43.00 SET** ⚠

**O-Rings**



**3652191.....29-59**  
Rubber, holds plug  
wires. 1-5/16 in. o.d.,  
3/4 in. i.d. 2.251 -0.4  
..... **\$2.50 SET** ⚠

**Spark Plugs**



**1559494.....33-54**  
Genuine AC 14 mm  
plug (exc 41-48) (6 pcs)  
2.270 -0.15  
..... **\$23.25 SET** ⚠



**1559459.....41-48**  
Genuine AC 10 mm plug  
(6 pcs) 2.270 -0.15  
..... **\$22.75 SET** ⚠

**Polarity Reverse Switch**



**1889827....41-42**  
On starter, w/ 1 in. x  
1-1/2 in. base (NOS)  
2.117 -0.4  
..... **\$55.00 EA** ⚠

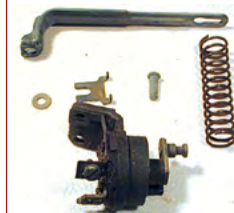

**1907122....46-48**  
On starter (NOS)  
2.117 -0.4  
..... **\$44.00 EA** ⚠

**Polarity Reverse Switch Wiring Harness**



**1881929....41-48**  
Wiring harness for  
reverse polarity  
switch. 2.122 -0.15  
..... **\$35.00 EA** ⚠



**Timing Hole Plug**



**836802A.....ALL**  
Rubber (rare) 0.714 -0.15  
..... **\$7.75 EA** ⚠️

**Ignition Switch**



**1116452.....40-54**  
Bolt-in replacement, w/ "Start" & "Accessory" positions - keeps original appearance (6v or 12v) Needs original key & lock cylinder '35-'57 trucks (#1458180) or '47-'48 trucks (#3716725) -not included. 2.188 -0.15 ..... **\$44.00 EA** ⚠️  
**1116452T.....47-53**  
Reproduction. Bolts in like original. Screw terminal. Foot starter & push button only. 2.188 -0.15 ..... **\$37.50 EA** ⚠️



**1116469D.....51-52**  
As original for 1951-52 car (no accessory position). Fits 1954-55 (1st Series) Chevy truck also. 2.188 -0.15 .. **\$48.75 EA** ⚠️



**1116452A.....ALL**  
Using a fork lift ignition switch? Use our flush mount switch w/ mounting bracket. Keep original appearance use lock cylinder #1458180 or #3716725 (including keys). 2.188 -0.15 ..... **\$45.00 SET** ⚠️

**Ignition Switch Mounting Bracket**



Faces rear of truck

**3684097.....47-53**  
Mounting bracket (behind dash). Chevy & GMC 2.192 -0.15 ..... **\$23.50 EA** ⚠️

**Ignition Switch Mounting Plate**



**3688155.....ALL**  
Universal mounting plate conforms to your dash to mount your switch (cylinder not included). 2.192 -0.3 ..... **\$10.25 EA** ⚠️

**Ignition Lock**



**1458180.....35-57**  
Cylinder & non-GM keys (Exc. 1947-48). 2.188 -0.15 ..... **\$14.00 EA** ⚠️



**3716725.....47-48**  
Cylinder & keys (non GM). 2.188 -0.15 ..... **\$17.75 EA** ⚠️

**Key Blank**



**601272.....35-54**  
Original GM round head. Fits trunk, glove box & locking gas cap 2.187 -0.2 ..... **\$4.00 EA** ⚠️



**3694624.....35-57**  
Original GM octagon head. Fits ignition, door & spare tire locks. 2.187 -0.15 ..... **\$2.50 EA** ⚠️

**Odds & Ends**

Please call for availability on all Odds & Ends parts; once part is sold, it may no longer be in stock.

**1853749U.....33-34**  
Electric lock cable (no key cylinder) 2.188 -0.4 ..... **\$50.00 EA** ⚠️  
**1847432.....34-37**  
Armature (Starter) All exc Dc 2.279 -0.4 ..... **\$42.00 EA** ⚠️  
**00875.....38-51**  
Ignition Coil NOS GMC w/ Fins 2.170 -0.4 ..... **\$50.00 EA** ⚠️  
**1855520.....39-48**  
Points 6.168 -0.4 ..... **\$15.00 EA** ⚠️  
**1112362U.....40-53**  
Distributor with points and cond (Used). 2.361 -0.4 ..... **\$75.00 EA** ⚠️  
**1112363.....51-52**  
Distributor, w/o contact plate (NOS) 2.361 -0.4 ..... **\$75.00 EA** ⚠️  
**1869573.....57**  
Bracket, Holds Condensor 8cyl Use w/ # 1112330 (NOS) 2.393 -0.15 ..... **\$2.00 EA** ⚠️

050T



**WARNING:** Cancer and Reproductive Harm — www.P65Warnings.ca.gov

Chemicals shipped domestic ground only (Lower 48 states only). No international shipping.

**Phone: (360) 816-0211 • (800) 999-CHEV (2438) • www.chevsofthe40s.com**

**SECTION 055T  
STREET ROD PARTS**

**Horns**



**HORN3 .....ALL**  
Ooogah horn. Heavy duty 12 volt motor. Easy installation. Limited lifetime warranty.

2.810 -0.2

..... **\$43.00 EA** ⚠



**46128 .....ALL**  
Wolf Whistle. Designed as Original. Works Reliably. Die Cast Metal with all Metal Hardware.

Classic Wolf Sound. Has Strong Vacuum Hose and Instructions. -0.15

..... **\$60.75 EA** ⚠

**SECTION 055T  
RESTORATION PARTS**

**Steering Wheels**



**755896 .....41-46**  
Black. Original in 41-45. Fits 36 spline 3/4" shaft. 6.513 -0.15

..... **\$173.75 EA** ⚠

**755896BR .....41-46**  
Brown. Original for 1946. 6.513 -0.15

**\$196.75 EA** ⚠



**756084A .....47-53**  
Black. Superior quality. Shaft size: 1 1/16", 36 splines. Chevy & GMC 6.513 -0.15

**\$173.75 EA** ⚠



**758625A ..... 54**  
Black. Superior quality, beautiful finish. Chevy & GMC 6.513 -0.15

..... **\$234.50 EA** ⚠

**Horns**



**9000518 .....40-54**  
W/ relay, 12v (pair). 2.810 -0.15

..... **\$69.00 SET** ⚠

**Horn Contact**



**265316 .....41-46**  
W/ spring. Fits COE only. 2.819 -0

..... **CALL** ⚠

**Horn Button Contact**



**270751 .....47-53**  
Horn Button Brush With Spring 2.819 -0.15

..... **\$10.00 EA** ⚠



**759037 .....47-57**  
Contact w/ spring. Fits 49-57 cars (& Corvette), 37-57 Comm & Util. 2.819 -0.15

..... **\$6.50 EA** ⚠

**Horn Contact Plate**

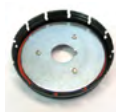

**758239 .....47-53**  
Horn button snaps over this plate. 2-5/8" O.D., 9/16" I.D. 2.819 -0.15

..... **\$21.25 EA** ⚠



**758566 .....54-59**  
Horn button snaps over. 2-1/2" O.D., 9/16" I.D. 2.819 -0

..... **\$24.50 EA** ⚠

**Cup W/ Chrome Rim**



**473258 .....29-40**  
For horn button. 2.819 -0.15

..... **CALL** ⚠

**Horn Button Assembly**



**753838 .....29-40**  
S-wire, rubber button & metal cap. 2.817 -0.15

..... **\$27.50 SET** ⚠

**Horn Button S-wire**



**753838B .....29-40**  
This is a S-wire that locates in the horn button 2.817 -0.15

..... **\$8.75 EA** ⚠

**Horn Button**



**753838C .....29-40**  
Metal cap on rubber horn button. 2.817 -0.15

..... **\$10.00 EA** ⚠



**124934 .....34-46**  
Steering Wheel Retaining Nut 6.515 -0.3

..... **\$1.00 EA** ⚠

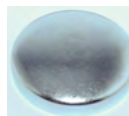

**609620 .....41-46**  
Horn Button 41-46 Chevrolet and GMC trucks. 2.817 -0.15

..... **\$38.00 EA** ⚠



**755850 .....47-53**  
Chrome & painted. 2.820 -0.15

..... **\$53.00 EA** ⚠



**3720100 ..... 54**  
Chrome & painted. 2.820 -0.15

..... **\$57.50 EA** ⚠

**Horn Button Pad**



**753838A .....29-40**  
Rubber. 2.817 -0.15

..... **\$12.50 EA** ⚠

**Horn Button Spring**



**755284 .....41-46**  
1-5/8" x 1-1/16" 2.816 -0.2

..... **\$8.00 EA** ⚠

**Horn Relay**



**1116775A .....34-54**  
6v, replacement. 2.815 -0.2

..... **\$15.00 EA** ⚠



**1116775B .....ALL**  
12v 2.815 -0.15

..... **\$15.50 EA** ⚠

**Wire Pigtails**



**1860035B .....53-54**  
On horn, cloth covered. 2.814 -0.15

..... **\$13.00 EA** ⚠



**Bushing w/ Horn Wire**



**1854761.....31-40**

Bushing under steering wheel w/ horn wire.

Also fits 36-40 GMC 6.521 -0

..... **\$62.25 EA** ⚠

**Bearing w/ Horn Wire**



**264887.....41-46**

Bearing under steering wheel, w/ horn wire.

6.521 -0.15

..... **\$23.00 EA** ⚠



**270255.....47-54**

Bearing under steering wheel, w/ horn wire.

Chevy & GMC 6.521 -0.15

..... **\$48.00 EA** ⚠

**Horn Wire Grommet**



**9000516.....40-54**

Horn wire thru horn cover (2 pcs). 2.810 -0.3

..... **\$5.00 SET** ⚠



**3711896.....41-46**

Horn wire thru steering column. 9.775 -0

..... **\$4.49 EA** ⚠

**Horn Button Retainer**

**754102.....41-46**

Horn button retainer Chevrolet and GMC 2.820 -0.15

..... **\$33.50 EA** ⚠



**WARNING:** Cancer and Reproductive Harm — [www.P65Warnings.ca.gov](http://www.P65Warnings.ca.gov)

Chemicals shipped domestic ground only (Lower 48 states only). No international shipping.

**Phone: (360) 816-0211 • (800) 999-CHEV (2438) • [www.chevsofthe40s.com](http://www.chevsofthe40s.com)**

**SECTION 060T  
STREET ROD PARTS**

**Main Wire Harness Street Rod  
Route 9**



**510625.....ALL**  
Route 9 Universal  
Wiring System from  
American Autowire. We  
often receive requests

for a basic, or smaller sized, complete  
wiring system, and this kit is designed  
just for that market. -0.15

**\$299.25 EA** ⚠

**Main Wire Harness Street Rod (Hwy  
15)**

HIGHWAY 15 "STREET ROD" WIRING KIT.  
This is a complete fuse panel and full wiring  
kit.

- Developed to handle the most demanding  
power requirements and accessories.
- Longer coils of wire so you can place the fuse  
box where YOU want it.



**13237.....ALL**  
American Autowire Highway 15-Street Rod  
Wire Harness 8.055 -0.15 **\$471.50 KIT**  
⚠

**Main Wire Harness Street Rod (Hwy  
15-Nostalgia)**



**500944.....ALL**  
American Autowire Highway 15-Nostalgia  
(Braided & Lacquered Wiring Kit) -0.15  
**\$1,399.00 KIT** ⚠

**Main Wire Harness Street Rod (Hwy  
22)**

The Highway 22 Panel packs all of the punch  
of a high-powered OEM system into a smaller,  
easy-to-install and extremely compact front  
loading package. The components used in  
this panel far exceed the power handling  
capabilities of any other manufacturer's  
system. Easy clamp-style system makes  
adding and removing wires easy! No Terminals!  
No Crimping! No Screws! Each Highway  
Series wiring kit comes with complete, easy to  
understand instructions to guide you through  
every step.

**500695.....ALL**  
Includes modern fuse box, instruction  
sheet, dash harness, instrument cluster  
kit, parking lamp kit, rear body kit, power  
plus front lighting kit, engine & starter kit,  
courtesy light connection kit, fuse relay  
flasher kit, ignition switch, headlight  
switch, dimmer switch and wire ties.  
2.555 -0.15 **\$529.50 KIT** ⚠

**Main Wire Harness Street Rod  
Truck**

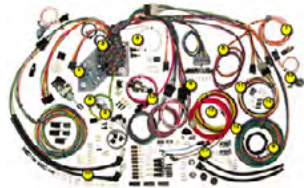

**2960053SR.....47-55**  
For 1947-55 Chevy Trucks. Built on the  
new 18 fuse, 21 circuit fuse box system,  
kit comes completely ready to install under  
the dash. Includes modern fuse box,  
instruction sheet, dash harness,  
instrument cluster kit, parking lamp kit,  
rear body kit, power plus front lighting kit,  
engine & starter kit, courtesy light  
connection kit, fuse relay flasher kit,  
ignition switch, headlight switch, dimmer  
switch and wire ties. 2.555 -0.15  
**\$619.75 SET** ⚠

**Custom Wiring Harness**



**CK-540.....ALL**  
Converts your stock 6 volt engine to 12  
volt or upgrade your existing 12 volt. -0.15  
**\$421.00 SET** ⚠

**Basic Auto Electricity Book**

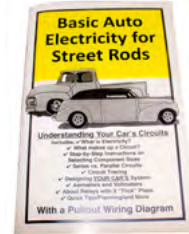

**WASBAEB.....ALL**  
Contains sections  
on: What is  
Electricity? Covers  
the battery,  
alternator, voltage  
regulator, grounding  
and fuses, designing  
a simple circuit &  
more including.

Circuit Diagram, Ammeter and Volt Meter  
usage. A full 48 pages plus Fold out  
Circuit Diagram and 8-1/2" x 14" Pullout  
Wiring Diagram to remove and customize  
to match your own car's circuits.  
0.000 -0.15

**\$11.00 EA** ⚠

**Clamp**



**120521A.....ALL**  
5/16 in, insulated bolt-  
on strap. For wire or  
tube (4 pcs). 8.950 -0.4

**\$3.29 SET** ⚠

**SECTION 060T  
RESTORATION PARTS**

**Main Wire Harness Chevrolet**

Note: Our cloth-covered wiring harnesses  
below are superb reproductions with braided  
harness cover and numbered ends for easy  
installation.

Note: Turn signals are located in Section 80T.

Some 1953 & all 1954 trucks used plastic  
wiring harnesses.



**1865315.....37-38**  
Original cloth 2.555 -0 **\$537.00 EA** ⚠

**1872970.....39**  
Original cloth 2.555 -0  
**\$523.00 EA** ⚠

**1872970A.....39**  
Original cloth (fits fire truck, commercial,  
etc.) 2.555 -0.15  
**\$523.00 EA** ⚠

**1879561.....40**  
Original cloth 2.555 -0.15  
**\$725.00 EA** ⚠





**Main Wire Harness Chevrolet, cont.**

- 4284502** ..... **41-46**  
Original cloth 2.550 -0.15  
..... **\$762.75 EA** ⚠
- 4188864** ..... **47-49**  
Original cloth 2.555 -0  
..... **\$815.00 EA** ⚠
- 5299874** ..... **50-53**  
Original cloth 2.555 -0.15  
..... **\$815.00 EA** ⚠

**Main Wire Harness GMC**

Some 1953 & all 1954 trucks used plastic wiring harnesses.



- 1865315G** ..... **37**  
GMC, original cloth, special order  
2.555 -0.15 ..... **\$765.00 EA** ⚠
- 1879561G** ..... **40**  
GMC, original cloth, special order  
2.555 -0.15 ..... **\$872.00 EA** ⚠
- 4284502G** ..... **41**  
GMC, original cloth, special order  
2.555 -0.15 ..... **\$872.00 EA** ⚠
- 5284496G** ..... **46**  
GMC, original cloth, special order  
2.555 -0.15 ..... **\$667.00 EA** ⚠
- 4188864G** ..... **47-49**  
GMC, original cloth, special order  
2.555 -0.15 ..... **\$934.75 EA** ⚠
- 5299874G** ..... **50-52**  
GMC, original cloth, special order  
2.555 -0.15 ..... **\$817.00 EA** ⚠
- 5299874A** ..... **53**  
GMC, original cloth, special order  
2.555 -0.15 ..... **\$944.19 EA** ⚠

**Main Wire Harness Replacement Chevrolet**

Note: Plastic wiring harnesses include turn signal harness.



- 1865315P** ..... **37-39**  
Plastic, generator. W/ voltage contact.  
2.555 -0 ..... **\$235.00 EA** ⚠
- 1865315PV** ..... **37-39**  
Plastic, alternator 2.555 -0  
..... **\$243.25 EA** ⚠
- 4284502P** ..... **40-46**  
Plastic, generator 2.555 -0.15  
..... **\$298.00 EA** ⚠
- 4284502PV** ..... **40-46**  
Plastic, alternator 2.555 -0  
..... **\$235.00 EA** ⚠
- 4188864P** ..... **47-49**  
..... **\$187.25 EA** ⚠
- 4188864PV** ..... **47-49**  
Plastic, alternator 2.555 -0.15  
..... **\$187.25 EA** ⚠
- 5299874P** ..... **50-52**  
Plastic, generator 2.555 -0.15  
..... **\$187.25 EA** ⚠
- 5299874PV** ..... **50-52**  
Plastic, alternator 2.555 -0.15  
..... **\$183.75 EA** ⚠
- 2960053P** ..... **53-54**  
Plastic, generator 2.555 -0.15  
..... **\$179.50 EA** ⚠
- 2960053PV** ..... **53-54**  
Plastic, alternator 2.555 -0.15  
..... **\$187.25 EA** ⚠

**Main Wire Harness Replacement GMC**

Note: Order GMC wire harnesses when you want to add electric temperature and oil pressure gauges to your Chevrolet truck.

- 1865315T** ..... **37-39**  
Plastic, GMC, generator 2.555 -0  
..... **\$235.00 EA** ⚠
- 1865315TV** ..... **37-39**  
Plastic, GMC, alternator 2.555 -0  
..... **\$243.25 EA** ⚠
- 4284502T** ..... **40-46**  
Plastic, GMC, generator 2.555 -0.15  
..... **\$298.00 EA** ⚠

**Main Wire Harness Replacement GMC, cont.**

- 4284502TV** ..... **40-46**  
Plastic, GMC, alternator 2.555 -0  
..... **\$235.00 EA** ⚠
- 4188864T** ..... **47-49**  
Plastic, GMC, generator 2.555 -0.15  
..... **\$210.00 EA** ⚠
- 4188864TV** ..... **47-49**  
Plastic, GMC, alternator 2.555 -0.15  
..... **\$215.00 EA** ⚠
- 5299874T** ..... **50-52**  
Plastic, GMC, generator 2.555 -0.15  
..... **\$210.00 EA** ⚠
- 5299874TV** ..... **50-52**  
Plastic, GMC, alternator 2.555 -0.15  
..... **\$215.00 EA** ⚠
- 2960053T** ..... **53-54**  
GMC, plastic, w/ generator 2.555 -0.15  
..... **\$212.59 EA** ⚠
- 2960053TV** ..... **53-54**  
GMC, plastic, w/ alternator 2.555 -0.15  
..... **\$215.00 EA** ⚠

**Headlight Pigtails**

Note: Turn signals are located in Section 80T.



- 918977** ..... **37-39**  
Exc COE 2.750 -0.15 ..... **\$66.00 PR** ⚠
- 5931796** ..... **41-46**  
And park light 2.750 -0.15  
..... **\$76.75 SET** ⚠



- 5942312** ..... **47-55**  
W/ grommets 2.750 -0.15 .. **\$83.00 PR** ⚠

# Section 060T: Wiring Harness, Wiring Clips, Terminal Boards

## Terminal Boards



**1865535** ..... **40-53**  
 (3 terminal) main wiring to headlight & park light pigtails w/ rivets. Mounting holes: 2-3/8" center-to-center. 2.560 -0.15  
 ..... **\$22.00 PR** ⚠



**1998756** ..... **40-54**  
 (4 terminal) main wiring to headlight & park light pigtails w/ rivets. Mounting holes: 3" center-to-center. 2.560 -0.15  
**\$28.00 PR** ⚠

## Heater Harness



**3106048B**... **37-49**  
 Heater & defroster wiring harness  
 8.853 -0.15  
 ..... **\$66.00 EA** ⚠

## Horn Harness



**1997713A**... **37-42**  
 Town & Country horn  
 2.832 -0.15  
 ..... **\$96.25 EA** ⚠



**1860035B** ..... **53-54**  
 On horn, cloth covered.  
 2.814 -0.15  
 ..... **\$13.00 EA** ⚠

## Polarity Reverse Switch Wiring Harness



**1881929**... **41-48**  
 Wiring harness for reverse polarity switch. 2.122 -0.15  
 ..... **\$35.00 EA** ⚠

## Transmission Wire Harness GMC

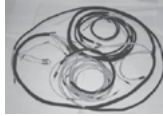

**5299874B**..... **53**  
 GMC, for hydramatic original cloth, special order 2.555 -0.15  
 ..... **\$197.00 EA** ⚠

## Wire Loom



**1846572** ..... **ALL**  
 Black, original hard cover to protect wiring, 1/4 in. i.d. 2.530 -0.2 ..... **\$2.00 FT** ⚠

**1846573** ..... **ALL**  
 Black, original hard cover to protect wiring, 3/8 in. i.d. 2.530 -0.15  
 ..... **\$1.50 FT** ⚠

**1846574** ..... **ALL**  
 Black, original hard cover to protect wiring, 5/16 in. i.d. 2.530 -0.15  
 ..... **\$1.50 FT** ⚠

**1846575** ..... **ALL**  
 Black, original hard cover to protect wiring, 7/16 in. i.d. 2.530 -0.15  
 ..... **\$2.00 FT** ⚠

**1846576** ..... **ALL**  
 Black, original hard cover to protect wiring, 1/2 in. i.d. 2.530 -0.15  
 ..... **\$2.00 FT** ⚠

## Wire



**985776A**..... **ALL**  
 Armored steel covered. 9.773 -0.3 ..... **\$0.75 IN** ⚠

**985777W** ..... **ALL**  
 Lacquer coated braided, white. 9.773 -0.2  
 ..... **\$0.25 IN** ⚠

## Clip



**148129**..... **ALL**  
 (1/2 in. Slot) wiring or tubing (4 Pcs) 8.950 -0.15

..... **\$9.50 SET** ⚠



**3735074A**..... **ALL**  
 1/8 in. slot, wiring or tubing (4 pcs) 8.950 -0.15

..... **CALL** ⚠



**3735074C**..... **ALL**  
 3/8 in. slot, gas, brake line, wire harness (4 pcs). 8.950 -0.15

..... **\$6.50 SET** ⚠

## Aluminum Bundle Straps



**13196**..... **ALL**  
 .25" W X 4.05" L  
 Used to bundle wires or hoses. -0.2  
**\$4.00 EA** ⚠



**13197**..... **ALL**  
 .25" W X 7.15 L"  
 Used to bundle wires or hoses -0.2  
**\$5.00 EA** ⚠



**SECTION 080T  
STREET ROD PARTS**

**Turn Signal Flasher LED**



**3713382L.....ALL**  
12V. For use w/ LED lights (3 prong). Low load . 2.892 -0.15  
..... **\$14.50 EA** ⚠️



**3713382L2.....ALL**  
12v. For use w/ LED lights (2 prong). Low load. 2.892 -0.15  
..... **\$17.75 EA** ⚠️



**FF552NL.....ALL**  
12v. For use w/ LED lights (2 prong). Adjustable blinker speed. 2.892 -0.15  
..... **\$51.75 EA** ⚠️



**FF552NLF.....ALL**  
12v. For use w/ LED (2 prong). Fixed blinker speed. 2.892 -0.15  
..... **\$10.75 EA** ⚠️



**FF552NLP.....ALL**  
12v. For use w/ LED (2 prong). Fully adjustable PULSING blinker speed control. 2.892 -0.15  
..... **\$51.25 EA** ⚠️

**LED Bulbs**

Note: LEDs are very directional and need to be angled correctly to be bright. Minimal current draw.



**145416ALED6A...ALL**  
6V Amber, offset pins. Replaces bulb #1154. 8.991 -0.2  
..... **\$11.50 EA** ⚠️

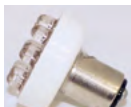

**145416J.....ALL**  
12V Amber, offset pins. Replaces bulb #1157. Use LED flasher #3713382L. 8.991 -0  
..... **CALL** ⚠️



**145416K.....ALL**  
12v Amber, straight pins. Replaces bulb #1156. Use LED flasher #3713382L. 8.991 -0.15  
..... **\$12.25 EA** ⚠️



**145416LED6A...ALL**  
6V Amber, straight pins. single contact Replaces bulb #1156. 8.991 -0.15  
..... **\$14.00 EA** ⚠️

**SECTION 080T  
RESTORATION PARTS**

**Park Light Assembly**



**595825.....37-39**  
Retainer plate & wire guide for park light 2.585 -0.15  
..... **\$23.50 L&R** ⚠️



**916957.....37-39**  
Accessory. Complete assembly, 12v 2.585 -0.15 ..... **\$115.00 EA** ⚠️



**916957T.....37-39**  
Accessory. Complete with turn signal. 12v 2.585 -0.15 ..... **\$115.00 EA** ⚠️



**928664.....47-53**  
Amber, 12v, double element bulb for turn signals. 2.585 -0.15 ..... **\$38.00 EA** ⚠️



**928664L.....47-53**  
LED Amber, 12v, dual function for park and turn signals. 2.585 -0.15 ..... **\$61.75 EA** ⚠️



**928665.....47-53**  
Clear, 6v. 2.585 -0.15 ..... **\$35.00 EA** ⚠️

**Park Light Assembly, cont.**

**928665B.....47-53**  
Clear, 12v, double element bulb for turn signals. 2.585 -0.15  
..... **\$39.25 EA** ⚠️



**897429.....54-55**  
55 1st series. 2.585 -0.15 ..... **\$43.50 EA** ⚠️

**Park Light Mounting Pads**



**603313.....37-39**  
Park light to fender (2 pcs) 2.599 -0.15  
..... **\$21.00 PR** ⚠️



**3650817.....40**  
Park light to fender 2.599 -0.15  
..... **\$6.00 PR** ⚠️



**917012.....41-42**  
Park light w/ die cast base. 2.599 -0.15  
..... **\$14.00 PR** ⚠️



**5932996A.....42-46**  
Park light w/ 1 pc tin cover (2 pcs). 2.599 -0.15 ..... **\$14.00 PR** ⚠️



**5936003G.....47-50**  
GMC park light (2 pcs). 2.599 -0.2  
..... **\$5.25 PR** ⚠️



**5936003F.....52-53**  
GMC park light (2 pcs). 2.599 -0.15  
..... **\$12.50 PR** ⚠️

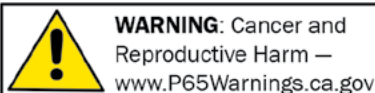

**WARNING:** Cancer and Reproductive Harm — www.P65Warnings.ca.gov

Chemicals shipped domestic ground only (Lower 48 states only). No international shipping.

Phone: (360) 816-0211 • (800) 999-CHEV (2438) • www.chevsofthe40s.com

080T

# Section 080T: Turn Signals, Flush Mount Kits, LED Bulbs & Park Lights

## Park Light Mounting Pads, cont.



**897429A** ..... 54  
Park light to fender.  
2.599 -0.15  
..... **\$10.75 PR** ⚠

## Park Light Rim



**5930230** ..... 40  
Stainless 2.593 -0.15  
..... **\$29.75 EA** ⚠



**5936795** ..... 47-53  
Chrome. 2.593 -0.15  
..... **\$10.00 EA** ⚠

## Park Light Rim Screws



**923315** ..... 40  
Stainless steel (2 pcs)  
2.688 -0.4  
..... **\$0.75 SET** ⚠



**5942152** ..... 47-53  
4 pcs. 2.594 -0.4  
..... **\$1.50 SET** ⚠

## Park Light Lens



**920249** ..... 37-39  
Accessory Glass  
2.589 -0.15  
..... **\$21.25 EA** ⚠



**924854** ..... 40  
Glass 2.589 -0.3  
..... **\$24.00 EA** ⚠



**5930136P** ..... 41-42  
Plastic, 4in. long for die  
cast housing. 2.589 -0.15  
..... **\$19.00 EA** ⚠



**5932977** ..... 42-46  
2in. long for tin cover  
housing. 2.589 -0.15  
..... **\$12.75 EA** ⚠



**5936802G** ..... 47-50  
GMC 2.589 -0.15  
..... **\$18.75 EA** ⚠



**5936801** ..... 47-53  
Amber, glass. 2.589 -0.15  
..... **\$10.00 EA** ⚠



**5936801L** ..... 47-53  
LED Amber lens, plastic.  
12 Volt 2.589 -0.15  
..... **\$34.25 EA** ⚠

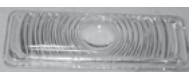

**5936802** ..... 47-53  
Clear, glass lens.  
2.589 -0.15  
..... **\$9.00 EA** ⚠

## Park Light Lens, cont.



**5935955** ..... 51-53  
GMC (glass). 2.589 -0.15  
..... **\$12.00 EA** ⚠



**5942151** ..... 54  
Clear 2.589 -0.15  
..... **\$6.75 EA** ⚠



**5942151A** ..... 54  
Amber 2.589 -0.15  
..... **\$8.00 EA** ⚠

## Park Light Lens Gasket



**922758** ..... 40  
Cork 2.590 -0.15  
..... **\$3.50 PR** ⚠



**5930153** ..... 41-42  
4 in. Long. 2.590 -0.2  
..... **\$5.00 PR** ⚠



**5932999** ..... 42-46  
2-3/16 in. long (2 pcs).  
2.590 -0.15  
..... **\$2.25 PR** ⚠



**5936804G** ..... 47-50  
GMC (2 pcs). 2.590 -0.15  
..... **\$3.50 PR** ⚠



**5936804** ..... 47-53  
2 pcs. 2.590 -0.15  
..... **\$3.75 SET** ⚠



**5936805G** ..... 51-53  
GMC (2 pcs). 2.590 -0.15  
..... **\$3.00 PR** ⚠



**5942513** ..... 54  
This is a park light  
lens gasket 2 pieces.  
2.590 -0.15  
..... **\$2.50 PR** ⚠

## Turn Signal Kit Self Canceling

- \* Operates on all cars - 6 or 12 volts, Positive or Negative Ground.
- \* Self Cancel feature uses time and lack of brake signal to know when to cancel.
- \* Time-out user adjustable for 15, 30, 45 or 60 seconds. Factory set for 15 seconds. Turn signal will not time out with the brakes applied.
- \* Audible beep on turn - user selectable for On/Off.
- \* Easy installation with included instructions, wiring diagrams and terminal labels on control.
- \* Fail safes with brake and park lights still functional even with blown turn signal control fuse or no power to the control box.
- \* Can operate with combined brake and turn lights or separate brake and turn lamps in rear of car.
- \* Can share front Park or Fog lights for front turn signals.
- \* Flash rate independent of lamp load. Will flash LED lamps or incandescent lamps at the same rate.
- \* 4-way Hazard function.
- \* Controller can use any style momentary switch(es) to access all control functions.
- \* 10 pin European style screw terminal connector prewired for power, ground and signal switch plug.
- \* Internal 15 amp turn function fuse and separate Park and Brake circuit 10 amp fuses.
- \* Quick disconnect of control box for easy service. Simply unplug the 10 pin connector.



**9857209B** ..... ALL  
Black column switch. 6 or 12 volt, positive or negative ground. Self canceling. -0.15  
..... **\$250.00 EA** ⚠



**9857209P** ..... ALL  
Plain column switch. 6 or 12 volt, positive or negative ground. Self canceling. -0.15  
..... **\$250.00 EA** ⚠

Returns require a return authorization number—call first. • Product pricing & availability subject to change.



**Turn Signal Kit Self Canceling, cont.**



**9857209T.....ALL**  
Toggle switch. 6 or 12 volt, positive or negative ground. Self canceling. -0.15  
**\$139.75 EA** ⚠️

**Halogen Turn Signal Kit w/ Harness**



**9857206TK.....37-53**  
W/ (2) 6v halogen bulbs, wire harness, flasher sockets & switch (specify year when ordering). 2.761 -0 .....starting at **\$240.00 SET** ⚠️

**9857212TK.....37-53**  
W/ (2) 12v halogen bulbs, wire harness, flasher sockets & switch (specify year when ordering). 2.761 -0  
.....starting at **\$240.00 SET** ⚠️

**Halogen Turn Signal Kit No Harness**

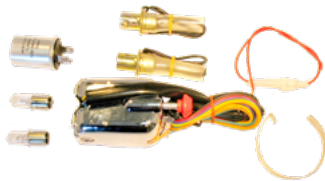

**9857207TK.....37-53**  
Comes With (2) 6v halogen bulbs, flasher sockets & switch, w/out wire harness (specify year when ordering). 2.761 -0  
starting at **\$110.00 SET** ⚠️

**9857208TK.....37-53**  
Comes With (2) 12v halogen bulbs, flasher sockets & switch, w/out wire harness (specify year when ordering). 2.761 -0  
.....starting at **\$120.00 SET** ⚠️

**Turn Signal Harness**



**985720A39.....37-39**  
Cloth, w/ flasher socket, extra pigtail for park lights and instructions 2.761 -0.15  
..... **\$226.75 EA** ⚠️

**985720A40.....40**  
Cloth, w/ flasher socket, extra pigtail for park lights and instructions 2.761 -0.15  
..... **\$226.75 EA** ⚠️

**985720D42.....41-42**  
Wire harness, plastic, w/ flasher socket, extra pigtail for park lights and instructions. 2.761 -0  
..... **\$186.00 EA** ⚠️

**985720D46.....42-46**  
Wire harness, plastic, w/ flasher socket, extra pigtail for park lights and instructions. 2.761 -0  
..... **\$186.00 EA** ⚠️

**985720D53.....47-53**  
Wire harness, plastic, w/ flasher socket, extra pigtail for park lights and instructions. 2.761 -0  
..... **\$186.00 EA** ⚠️

**Turn Signal Switch**



**5944127.....54-62**  
Original w/ pigtails 2.895 -0  
..... **\$25.00 EA** ⚠️



**985720.....ALL**  
Superior, with four way flasher 2.895 -0.15  
..... **\$33.00 EA** ⚠️



**985720E.....ALL**  
Economy 2.895 -0.15 ..... **\$25.00 EA** ⚠️

**Turn Signal Knob**



**5939511A.....54-59**  
Black, original color and quality. 2.906 -0.4  
..... **\$14.00 EA** ⚠️

**Flasher Socket**



**5297633.....ALL**  
W/ mounting bracket, three prong. 2.892 -0.15  
..... **\$14.75 EA** ⚠️

**Turn Signal Flasher**



**1335230.....ALL**  
6v 3 prong 2.892 -0.4  
..... **\$7.00 EA** ⚠️



**3713382.....ALL**  
12v 3 prong 2.892 -0.2  
..... **\$10.25 EA** ⚠️

**Turn Signal Flasher Audible**



**1335230TA.....ALL**  
Audible flasher. 6v, 3 prong. 2.892 -0.15  
..... **\$36.25 EA** ⚠️

**3713382TA.....ALL**  
Audible flasher. 12v, 3 prong. 2.892 -0.15  
..... **\$32.50 EA** ⚠️

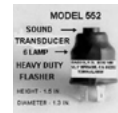

**FF552TA.....ALL**  
Audible flasher. 12v, 2 prong. -0.15  
..... **\$29.25 EA** ⚠️

**Sockets & Bulbs For Park Lights w/ Turn Signals**

Halogen Bulbs can be added to following kits for an additional \$20.

Park light socket and bulb kits also available with halogen or LED bulbs.



**1873702S.....37-39**  
6v 2.750 -0.15 ..... **\$12.00 SET** ⚠️

**1873702U.....37-39**  
12v 2.750 -0 ..... **\$11.50 SET** ⚠️

**5930046S.....40**  
6v 2.750 -0.15 ..... **CALL** ⚠️

**Sockets & Bulbs For Park Lights w/  
Turn Signals, cont.**

**5930046U** ..... **40**  
12v -0.15

..... **CALL** ⚠

**5930153S** ..... **41-42**  
6v 2.750 -0.3

..... **\$17.50 SET** ⚠

**5930153U** ..... **41-42**  
12v 2.750 -0.3

..... **\$17.00 SET** ⚠

**5032299S** ..... **42-46**  
6v 2.750 -0.3

..... **\$17.50 SET** ⚠

**5032299U** ..... **42-46**  
12v 2.750 -0.3

..... **\$17.00 SET** ⚠

**5936804S** ..... **47-53**  
6v 2.750 -0.3

..... **\$17.50 SET** ⚠

**5936804U** ..... **47-53**  
12v 2.750 -0.3

..... **\$17.00 SET** ⚠

**5942094S** ..... **54**  
6v 2.596 -0.3

..... **\$17.50 SET** ⚠

**5942094U** ..... **54**  
12v 2.750 -0.3

..... **\$17.00 SET** ⚠

**LED Bulbs**

**145416N** ..... **ALL**  
12v Amber, straight pins. Replaces bulb  
#1156. Use LED flasher #3713382L.  
8.991 -0.15

..... **\$15.00 EA** ⚠

**Park Light Grommet**



**928665A** ..... **47-54**  
Park light wire-thru  
housing. 2.596 -0.15

..... **\$3.50 PR** ⚠



**SECTION 085T  
RESTORATION PARTS**

Note: Fog and driving lights are GM script w/ brackets, switch & wiring. Fog lights are amber, driving lights are clear.

Note: Headlight and spotlight bulbs see Section 100T.

**Driving Lights**

**409185** ..... **ALL**  
Clear, 6v, 5 in. (specify year when ordering). 9.774 -0  
..... starting at **\$244.00 PR** ⚠



**409185A** ..... **ALL**  
Clear, 12v, 5 in. (specify year when ordering). 9.774 -0.4  
..... starting at **\$241.00 PR** ⚠

**409186** ..... **ALL**  
Clear, 6v, 6 in. (specify year when ordering). 9.774 -0  
..... starting at **\$244.00 PR** ⚠

**409186A** ..... **ALL**  
Clear 12v, 6 in. (specify year when ordering). 9.774 -0  
..... starting at **\$244.00 PR** ⚠

**Fog Light**



**985174** ..... **37-38**  
Amber nice repro w/ brackets. 9.774 -0.15  
..... **\$225.00 PR** ⚠

**985174C** ..... **37-38**  
Amber nice repro w/ chrome brackets. 9.774 -0  
..... **\$245.00 PR** ⚠



**985444** ..... **39**  
Amber nice repro w/ brackets. 9.774 -0.15  
..... **\$225.50 PR** ⚠

**985444C** ..... **39**  
Amber nice repro w/ chrome brackets. 9.774 -0  
..... **\$245.50 PR** ⚠

**Fog Light, cont.**

**985448** ..... **40**  
Amber nice repro w/ brackets. -0  
..... **\$450.25 PR** ⚠

**985448C40** ..... **40**  
Amber nice repro w/ chrome brackets. -0  
..... **\$489.25 PR** ⚠



**409182** ..... **ALL**  
Amber with GM script. 6v, 5 in. dia. (specify year when ordering). 9.774 -0  
..... starting at **\$244.00 PR** ⚠

**409182A** ..... **ALL**  
Amber with GM script. 12v, 5 in. dia. (specify year when ordering). 9.774 -0  
..... starting at **\$244.00 PR** ⚠

**409183** ..... **ALL**  
Amber with GM script. 6v, 6in. dia. (specify year when ordering). 9.774 -0  
..... starting at **\$244.00 PR** ⚠

**409183A** ..... **ALL**  
Amber with GM script. 12v, 6in. dia. (specify year when ordering). 9.774 -0  
..... starting at **\$244.00 PR** ⚠

**Fog Light Lens**



**921415** ..... **37-38**  
Amber. 6-5/16" o.d. 9.774 -0.15  
..... **\$25.00 EA** ⚠



**923706** ..... **39**  
Amber (original repro). 6-3/4" dia. 9.774 -0  
..... **CALL** ⚠

**Fog Light Lens, cont.**



**923706R** ..... **39**  
Amber. Fits reproduction fog lights. 6-1/4" o.d. 9.774 -0.15  
..... **\$30.50 EA** ⚠

**Fog Light Rim**



**5930366** ..... **40**  
Chrome (NOS). 7" o.d. 9.774 -0  
..... **CALL** ⚠

**Fog Light Emblem**



**984716E** ..... **41**  
Painted details  
9.774 -0  
..... **CALL** ⚠

**GM Script Tag**



**985993M** ... **37-54**  
Top of driving lights, fog lights and spotlight. 9.773 -0.2  
..... **\$9.59 EA** ⚠

**Fog Light Bracket**

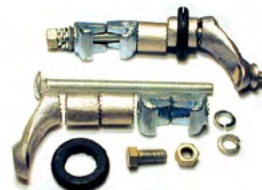

**5933244** ..... **ALL**  
W/ apron on bumper brackets. 9.774 -0.15  
..... **\$40.00 SET** ⚠



**WARNING:** Cancer and Reproductive Harm — [www.P65Warnings.ca.gov](http://www.P65Warnings.ca.gov)

Chemicals shipped domestic ground only (Lower 48 states only). No international shipping.

**Phone: (360) 816-0211 • (800) 999-CHEV (2438) • www.chevsofthe40s.com**

# Section 085T: Driving Lights, Fog Lights & Spot Lights

## Switch



**924160** ..... **ALL**  
 Fog light, backup light, etc, rotary. Clamps  
 to dash bottom. 9.774 -0.2 .....  
**\$23.00 EA** ⚠

## Spotlights

Note: Spotlights have GM script and include  
 right or left bracket and template.



**985993A** ..... **.37-54**  
 6v, 6 in., (specify year & left or right when  
 ordering). 9.773 -0 ..... **starting at \$326.00 EA**  
 ⚠

**985993F** ..... **.37-54**  
 12v, 6 in., (specify year & left or right  
 when ordering). 9.773 -0  
 ..... **starting at \$326.00 EA** ⚠

**985993G** ..... **.37-54**  
 12v, 5 in. (specify year & left or right  
 when ordering). 9.773 -0  
 ..... **starting at \$326.00 EA** ⚠

**985993H** ..... **.37-54**  
 6v, 5 in. (specify year & left or right when  
 ordering). 9.773 -0  
 ..... **starting at \$326.00 EA** ⚠

## Spotlight Brackets



**985993TL** ..... **.37-54**  
 Left (specify year when ordering). 9.773 -0  
 ..... **starting at \$54.00 EA** ⚠

**985993TR** ..... **.37-54**  
 Right (specify year when ordering). 9.773 -0  
 ..... **starting at \$54.00 EA** ⚠

## Spotlight Handle



**985998B** ..... **ALL**  
 Ivory w/ chrome housing & switch for  
 spotlight. 9.773 -0.15 ..... **\$60.00 EA** ⚠

## Wire Assembly



9.773 -0.2  
 ..... **\$31.00 SET** ⚠

**985774A** ..... **ALL**  
 W/ armored steel  
 covered, cloth wire &  
 metal fuse holder for  
 spotlight, as original.

## Fuse Holder



**985775A** ..... **ALL**  
 Metal fuse holder.  
 9.773 -0.15  
 ..... **\$12.00 EA** ⚠

## Wire



**985776A** ..... **ALL**  
 Armored steel covered. 9.773 -0.3 .....  
**\$0.75 IN** ⚠  
**985777W** ..... **ALL**  
 Lacquer coated braided, white. 9.773 -0.2  
 ..... **\$0.25 IN** ⚠





# Section 090T: Headlight Components, Frenched Kits, Halogen Conversions, Rims, Seals & Switches

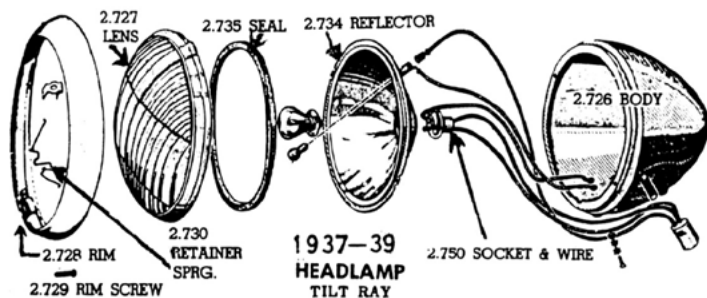

**1937-39 HEADLAMP TILT RAY**

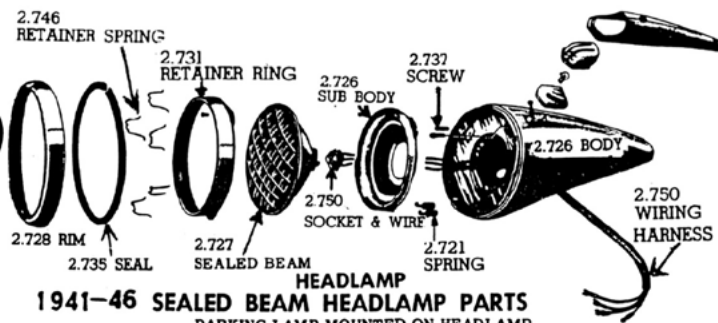

**1941-46 SEALED BEAM HEADLAMP PARTS**  
PARKING LAMP MOUNTED ON HEADLAMP

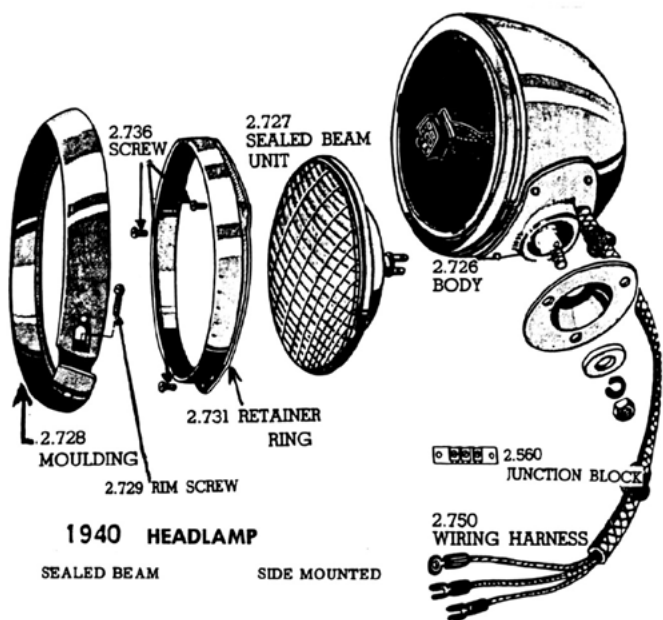

**1940 HEADLAMP**  
SEALED BEAM SIDE MOUNTED

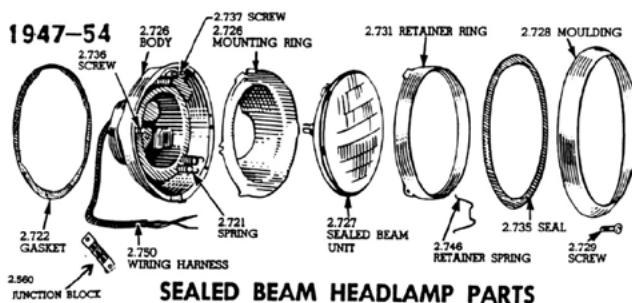

**1947-54 SEALED BEAM HEADLAMP PARTS**

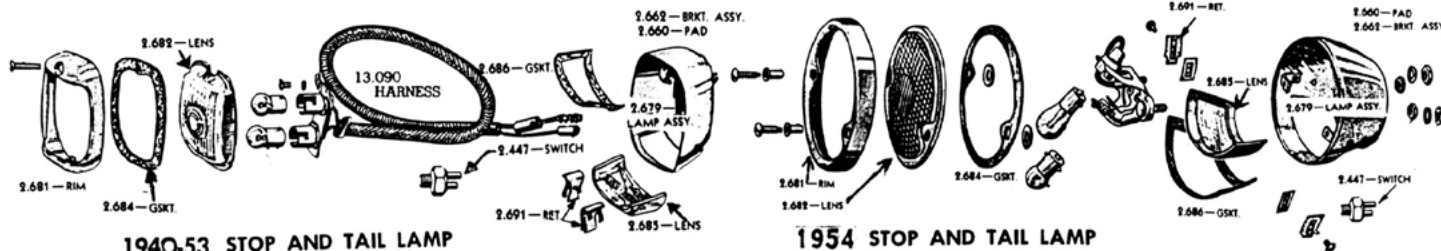

**1940-53 STOP AND TAIL LAMP**

**1954 STOP AND TAIL LAMP**



**WARNING:** Cancer and Reproductive Harm — [www.P65Warnings.ca.gov](http://www.P65Warnings.ca.gov)

Chemicals shipped domestic ground only (Lower 48 states only). No international shipping.

Phone: (360) 816-0211 • (800) 999-CHEV (2438) • [www.chevsofthe40s.com](http://www.chevsofthe40s.com)

**SECTION 090T  
STREET ROD PARTS**

**Halogen Headlight with LED Turn Signal**



**31378.....ALL**  
7 inch, 12 Volt H-4 Halogens with amber LED turn signal or marker lights One row of LED lights on each side. Glass lens.  
2.726 -0.15 ..... **\$66.00 EA** ⚠

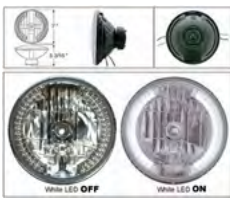

**31379.....ALL**  
7 inch, 12 Volt H-4 Halogens with white LED turn signal or marker lights. One row of LED lights on each side. Glass lens.  
2.726 -0.15 ..... **\$65.75 EA** ⚠



**S2010LED.....ALL**  
7 inch, 12 Volt H-4 Halogens with amber LED turn signal-marker lights. One row of LEDs at the bottom of light. Glass lens.  
-0.15 ..... **\$49.00 EA** ⚠

**Halogen Headlight with LED Halo**



**31380HALO.....ALL**  
7 Inch, 12 Volt Headlight H-4 Halogens With Multi Color LED Halo, Includes Remote (No Turn Signal).  
NOTE: Will not work on 37-38 Sealed Beam Conversion Kit (#920544S) -0.15  
..... **\$270.25 PR** ⚠

**Halogen Headlight with LED Halo, cont.**



**31381HALO.....ALL**  
7 Inch, 12 Volt Headlight H-4 Halogens With White LED Halo (No Turn Signal)  
NOTE: Will not work on 37-38 Sealed Beam Conversion Kit (#920544S) -0.15  
..... **\$195.25 PR** ⚠

**31382HALO.....ALL**  
7 Inch, 12 Volt Headlight H-4 Halogens With Multi-Color LED Halo, includes remote. Black Illusion (No Turn Signal)  
-0.15 ..... **\$299.99 PR** ⚠



**31383HALO.....ALL**  
7 Inch, 12 Volt Headlight H-4 Halogens With Multi Color LED Halo and Amber Turn signals, Includes Remote.  
NOTE: Will not work on 37-38 Sealed Beam Conversion Kit (#920544S) -0.15  
..... **\$320.25 PR** ⚠



**31384HALO.....ALL**  
7 Inch, 12 Volt Headlight H-4 Halogens With White LED Halo and Amber Turn Signals.  
NOTE: Will not work on 37-38 Sealed Beam Conversion Kit (#920544S) -0.15  
..... **\$245.25 PR** ⚠

**LED Headlight Kit**



**5947212L.....ALL**  
Includes 2 - 7 inch headlights and LED bulbs. -0 ..... **\$150.00 SET** ⚠

**Halogen Headlights**



**110185H.....ALL**  
7 inch 6V. Flat lens & replaceable halogen bulb. 2.727 -0 ..... **\$41.50 EA** ⚠



**5947212H.....ALL**  
7 inch, 12V. Flat glass lens & replaceable halogen bulb. 2.727 -0 ... **\$19.50 EA** ⚠



**T70100A.....ALL**  
7 inch Clear glass w/ diamond cut reflector. Comes w/ H4 55/60 watt xenon filled bulb. 2.727 -0.15 .... **\$70.09 EA** ⚠



**T70300A.....ALL**  
7 inch Clear glass w/ diamond cut reflector & Tri-Bar w/ blue-dot. Comes w/ H4 55/60 watt xenon filled bulb. 2.727 -0.15 ..... **\$100.09 EA** ⚠

# Section 090T: Headlight Components, Frenched Kits, Halogen Conversions, Rims, Seals & Switches

## LED Headlight Conversion

The Features Of LED Conversion Kit

1. Brightness reaches 8000 Lumens, in comparison a standard 55w H4 halogen bulb is about 1000 lumens.
2. Anti-glare design, better light pattern output
3. Life span over 30,000 hours
4. Excellent heat dissipation
5. Easy for installation (Plug-in Play)
6. Waterproof and dustproof. IP65



**MAI005.....ALL**  
Single beam LED headlight conversion kit. Replaces 9006 Bulbs

Input voltage:DC 10V-32V. -0.2

..... **\$125.89 PR** ⚠



**MAI011.....ALL**  
Hi/Low beam LED headlight conversion kit. Replaces H4 bulbs.

Voltage: DC 10V-32V. -0.15

..... **\$65.00 PR** ⚠

## HID Headlight Conversion

The Features Of HID Conversion

Brighter/whiter illumination  
HID lighting provides a crystal white beam of light that increases night time visibility by 3 times.

Quick snap water proof connectors, 35% less power consumption than a standard halogen. Over 2000 hours of HID bulb life.

HID (High Intensity Discharge) Headlight Conversion. H4 6000K.

Convert your current halogens to Xenon HID.

Plug and play installation including instructions and ballast mounting hardware.

35 watts will draw less 3 amps.

3600 Lumens, in comparison a standard 55w H4 halogen bulb is about 1000 lumens.

\*Race use only.

## HID Headlight Conversion, cont.



**HIDCONV01.....ALL**  
Low beam Xenon HID w/ H4 Halogen high beam. 6000K.(off-road use only).

2.727 -0.15 ..... **\$100.00 PR** ⚠

**HIDCONV02.....ALL**  
Low & High beam Xenon. Converts halogens. H4 6000K. (off-road use only).

2.727 -0.15 ..... **\$88.75 PR** ⚠

## Halogen Headlight Conversion



**110185A.....31-39**  
Halogen bulb. 12V headlight conversion.

Double the light of sealed beam, retains original appearance. Uses original lens & reflector. Clear. Some trimming/modifications may be necessary. 8.991 -0.15

..... **CALL** ⚠

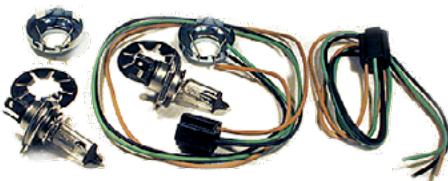

**110185D.....31-39**  
Halogen bulb. 6V headlight conversion.

Double the light of sealed beam, retains original appearance. Uses original lens & reflector. Clear. Some trimming/modifications may be necessary. 8.991 -0.15

..... **\$45.00 PR** ⚠

## Tri-Bar Headlight Cover Blue Dot



**193142TB.....ALL**  
Blue Dot. Fits 7 inch headlights. 2.731 -0.15

..... **\$10.00 EA** ⚠

## Tri-Bar Headlight Cover Chrome Bullet



**193142TC.....ALL**  
Chrome Bullet. Fits 7 inch headlights.

2.731 -0.15 ..... **\$9.75 EA** ⚠

## Headlight Visors



**193142A.....ALL**  
Chrome half moon. Fits 7 inch round headlights.

2.731 -0.2 ..... **\$10.25 PR** ⚠



**193142AM.....ALL**  
Amber acrylic with chrome trim plate. Fits 7 inch round headlights.

2.731 -0.15 ..... **\$13.25 PR** ⚠



**193142B.....ALL**  
Chrome plated w/ blue dot jewel. Fits 7 inch round headlights.

2.731 -0.15 ..... **\$22.75 PR** ⚠



**193142BL.....ALL**  
Blue acrylic with chrome trim plate. Fits 7" round.

2.731 -0.15 ..... **\$13.25 PR** ⚠



**193142D.....ALL**  
Chrome plated. Fits 7 inch round headlights.

2.731 -0.15 ..... **\$19.00 PR** ⚠



**193142GR.....ALL**  
Green acrylic with chrome trim plate. Fits 7" round.

2.731 -0.15 ..... **\$13.25 PR** ⚠



**193142RE.....ALL**  
Red acrylic with chrome trim plate. Fits 7" round.

2.731 -0 ..... **CALL** ⚠



**WARNING:** Cancer and Reproductive Harm — www.P65Warnings.ca.gov

Chemicals shipped domestic ground only (Lower 48 states only). No international shipping.

Phone: (360) 816-0211 • (800) 999-CHEV (2438) • www.chevsofthe40s.com

# Section 090T: Headlight Components, Frenched Kits, Halogen Conversions, Rims, Seals & Switches

## SECTION 090T RESTORATION PARTS

Note: Headlight Knobs see Sections 340T.

Note: Headlight bulbs see Section 100T.

### Headlight Bulbs Sealed Beam



**193142** ..... **.40-54**  
Sealed beam 6v. 2.727 -0 ..... **CALL** ⚠



**193142H** ..... **.40-54**  
Halogen Sealed beam 6v. 2.727 -0.2 ...  
**\$26.75 EA** ⚠



**5947212** ..... **.ALL**  
Sealed beam 12v. 2.727 -0.15 .....  
**\$14.75 EA** ⚠

### Headlight Bucket Assembly



**5932796C** ..... **.47-54**  
Complete w/ pigtail, retainer & 12v bulb,  
no rim. 2.726 -0.15 ..... **\$75.00 EA** ⚠



**5932796D** ..... **.47-54**  
Complete w/ original style pigtail (plastic  
wires in cloth loom), retainer & 12v bulb  
(no rim). 2.726 -0 ..... **\$95.00 EA** ⚠

### Headlight Lens

**919787** ..... **.37-39**  
Glass replacement lens (exc COE) 2.727 -0  
..... **\$40.00 EA** ⚠

### Headlight Bucket Housing



**919475FL** ..... **.37-40**  
Fiberglass Left side.  
Commercial Only  
2.726 -0  
..... **CALL** ⚠



**919475FR** ..... **.37-40**  
Fiberglass Right side.  
Commercial Only.  
2.726 -0  
..... **CALL** ⚠

### Headlight Bucket Stand



**350777F** ..... **.37-40**  
Fiberglass, left. 2.544 -0  
..... **CALL** ⚠



**350778F** ..... **.37-40**  
Fiberglass, right. 2.544 -0  
..... **CALL** ⚠

### Headlight Bucket



**924535** ..... **.41-54**  
Inner bucket only. Steel 2.726 -0 .....  
**\$36.00 EA** ⚠

### Headlight Wire Grommet



**5931584** ..... **.47-54**  
Bucket for pigtail (2  
pcs). 9.775 -0.15  
..... **\$4.00 PR** ⚠

### Headlight Grommet



**3673139** ..... **.47-53**  
Fender inner panel.  
9.775 -0.4  
..... **\$3.50 SET** ⚠

### Headlight Bucket Pad



**5933134** ..... **.41-46**  
Headlight bucket to  
fender. 2.544 -0.15  
..... **\$19.00 PR** ⚠

### Headlight Bucket Gasket



**3722121** ..... **.47-54**  
Headlight bucket to  
fender. 8-1/2 in. x 1/8  
in. thick. 2.722 -0.15  
..... **\$7.00 PR** ⚠

### Headlight Stand Mounting Pad

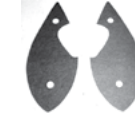

**476489** ..... **.37**  
Left and right. 2.544 -0.15  
..... **\$7.00 L&R** ⚠



**597992** ..... **.38**  
Left and right. 2.544 -0.15  
..... **\$7.00 L&R** ⚠



**350910** ..... **.39-40**  
Left and right. 2.544 -0.15  
..... **\$7.00 L&R** ⚠

### Clutch Head Screws



**5932796A** ..... **.47-54**  
With tin u-nuts, attach headlight bucket to  
fender (32 pcs). 2.726 -0 ..... **\$10.50 SET**  
⚠

### Clutch Head Driver



**DRIVER** ..... **.ALL**  
Magnetic clutch head driver, Chev's  
imprint. w/ 5 bits (1/8 in., 5/32 in., 3/16  
in., 1/4 in., 5/16 in.) 8.821 -0 .....  
**\$22.25 SET** ⚠

### Headlight Bucket Spring



**924551** ..... **.41-46**  
Tension adjusting.  
2.721 -0.15  
..... **\$5.50 EA** ⚠



**5937452** ..... **.47-54**  
Tension adjusting.  
2.721 -0.15  
..... **\$3.50 EA** ⚠

Returns require a return authorization number—call first. • Product pricing & availability subject to change.



**WARNING:** Cancer and  
Reproductive Harm —  
www.P65Warnings.ca.gov

# Section 090T: Headlight Components, Frenched Kits, Halogen Conversions, Rims, Seals & Switches

## Headlight Rim



**921514.....36-39**  
 Chrome (36 car, 37-39 trucks exc COE). Does not come with tab or screw 2.728 -0.15

..... **\$35.00 EA** ⚠



**5930416..... 40**  
 Chrome reproduction. 2.728 -0.15

..... **\$45.00 EA** ⚠



**924722.....41-46**  
 Chrome 2.728 -0.15

..... **\$27.50 EA** ⚠



**5941285.....47-54**  
 Stainless Steel w/ clips. 2.728 -0.15

..... **\$18.75 EA** ⚠

## Headlight Lens Seal



**605918.....32-39**  
 2 pieces. 2.735 -0.3

..... **\$11.25 PR** ⚠



**5930594A ....40-54**  
 Headlight rim to sealed beam retainer 2.735 -0.3

..... **\$14.50 SET** ⚠



**5930594C ....40-54**  
 W/ wire insert headlight rim to retainer 2.735 -0

..... **\$16.00 PR** ⚠

## Headlight Rim Seal Clip



**5934791.....37-39**  
 Does 2. 2.746 -0.2

..... **\$8.00 SET** ⚠

**5934791..... 40-54**

Does 2. 2.746 -0.2

..... **\$8.00 SET** ⚠

## Sealed Beam Retainer Ring



**5930433..... 40**  
 Stainless steel 2.731 -0.15

..... **\$20.75 EA** ⚠



**924534.....41-54**  
 Stainless steel 2.731 -0

..... **\$9.50 EA** ⚠



**924534S.....41-54**  
 Stainless steel 2.731 -0

..... **\$10.00 EA** ⚠

## Sealed Beam Retainer Ring Screws



**924622.....40-54**  
 Retainer screws (3 pcs) 2.729 -0.4

..... **\$3.00 SET** ⚠

## Terminal Boards



2-3/8" center to center

**1865535.....40-53**

(3 terminal) main wiring to headlight & park light pigtailed w/ rivets. Mounting holes: 2-3/8" center-to-center. 2.560 -0.15

..... **\$22.00 PR** ⚠

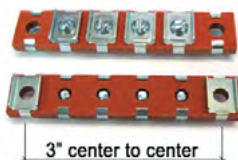

3" center to center

**1998756.....40-54**

(4 terminal) main wiring to headlight & park light pigtailed w/ rivets. Mounting holes: 3" center-to-center. 2.560 -0.15

..... **\$28.00 PR** ⚠

## Headlight Switch



**1995040.....30-46**

Replacement 2.485 -0

... **\$25.00 EA** ⚠



**1995040A.....30-46**

Delco original replacement, w/ removable shaft. Black knob, white "LIGHTS" text. 2.485 -0

..... **CALL** ⚠

## Headlight Switch, cont.



**1994007..... 39**

Genuine Delco, NOS. 2.485 -0.15

..... **\$145.00 EA** ⚠



**1995041A.....47-54**

Replacement, nonremovable shaft. 12volt. 2.485 -0.15

..... **\$19.75 EA** ⚠



**1995041R.....47-54**

For use w/ original nut, knob & removable shaft (locking groove on end only). Includes spade terminals. 12v 2.485 -0

..... **\$45.75 EA** ⚠



**1995041S.....47-54**

6 Volt. Uses original nut, knob & removable shaft. Includes spade terminals (for units w/ locking groove at end of shaft). Chevy & GMC 2.485 -0.15

..... **\$52.00 EA** ⚠



**1995041T.....47-54**

12 Volt. Uses original nut, knob & removable shaft. Includes spade terminals (for units w/ locking groove at end of shaft). Chevy & GMC 2.485 -0.15

..... **\$50.50 EA** ⚠



**WARNING:** Cancer and Reproductive Harm — [www.P65Warnings.ca.gov](http://www.P65Warnings.ca.gov)

Chemicals shipped domestic ground only (Lower 48 states only). No international shipping.

Phone: (360) 816-0211 • (800) 999-CHEV (2438) • [www.chevsofthe40s.com](http://www.chevsofthe40s.com)

# Section 090T: Headlight Components, Frenched Kits, Halogen Conversions, Rims, Seals & Switches

## Headlight Switch Shaft



**1990661** .....47-53  
 Chrome with maroon center. With shaft  
 2.486 -0.15 ..... **\$8.75 EA** ⚠



**1990661A** .....47-53  
 Chrome with maroon center. Original color and quality. 2.486 -0.15

..... **\$14.00 EA** ⚠



**3653818S** .....47-54  
 Removable type. 2.485 -0 ..... **\$5.00 EA** ⚠

## Headlight Switch Retaining Nut



**1995041C** .....47-54  
 Stainless 2.485 -0 ..... **\$12.50 EA** ⚠

## Dimmer Switch



**1997008** .....29-54  
 Dimmer Switch. Includes fasteners.  
 2.459 -0.2 ..... **\$23.50 EA** ⚠

## Headlight Relay



**1116789A** .....37-54  
 6v replacement style. 2.485 -0.15 .....  
**\$34.25 EA** ⚠



**1116789B** .....ALL  
 12v 2.485 -0.3 ..... **\$59.00 EA** ⚠

## Odds & Ends

Please call for availability on all Odds & Ends parts; once part is sold, it may no longer be in stock.

**03870** .....37-46  
 Headlight Switch, 37-38 Pass & 40-46  
 Truck 9.000 -0.4

..... **\$55.00 EA** ⚠

**350966U** .....39-40  
 Headlight stand, right side (Used)  
 2.546 -0.4

..... **\$60.00 EA** ⚠

**03790** .....47-53  
 Headlight knob w/ shaft, good used  
 2.485 -0.4

..... **\$8.00 EA** ⚠

**1995041U** .....47-54  
 Headlight Switch 2.487 -0.4

..... **\$95.00 EA** ⚠



**SECTION 100T  
STREET ROD PARTS**

**Halogen Headlight Conversion Bulb**



**110185B.....ALL**  
Headlight bulb. Clear  
6v, H4 replacement.  
8.991 -0.15  
..... **\$18.50 EA** ⚠



**110185C.....ALL**  
Headlight bulb. Clear  
12v, H4 replacement.  
8.991 -0.15  
..... **\$15.00 EA** ⚠

**Halogen Bulbs**



**145416B.....37-54**  
Halogen tail light & park  
light w/ turn signal, 12v,  
dual filament, 30/10  
watt, offset pin, replacement for #1157.  
8.991 -0.15  
..... **\$8.00 EA** ⚠



**145416C.....37-54**  
Halogen tail light & park  
light, 6v 50 watt, single  
filament, straight pin. 8.991 -0.15  
..... **\$14.00 EA** ⚠



**145416D.....37-54**  
Halogen tail light & park  
light, 6v 20 watt, single  
filament, straight pin.  
8.991 -0.15  
..... **\$17.00 EA** ⚠



**145416F.....37-54**  
Halogen tail light & park  
light w/ turn signal,  
6v 23/5 watt, dual  
filament, straight pin, replacement for  
#1158. 8.991 -0.15  
..... **\$27.25 EA** ⚠



**145416E.....ALL**  
Halogen tail light & park  
light w/ turn signal,  
6v 65/10 watt, dual  
filament, offset pin,  
replacement for #1154. 8.991 -0.15  
..... **\$17.00 EA** ⚠



**145416G.....ALL**  
Halogen tail light & park  
light w/ turn signal,  
12v, dual filament,  
55/5 watt, straight pins, replacement for  
#1156. 8.991 -0.15  
..... **\$20.00 EA** ⚠

**Halogen Bulbs, cont.**



**145416H.....ALL**  
Halogen tail light &  
park light, 12v 20 watt,  
single filament, straight  
pin. 8.991 -0.3  
..... **\$12.00 EA** ⚠



**145416I.....ALL**  
Halogen tail light &  
park light, 12v 20 watt,  
single filament, straight  
pin. 8.991 -0.15  
..... **\$12.25 EA** ⚠

**LED Bulbs**

Note: LEDs are very directional and need to be angled correctly to be bright. Minimal current draw.



**145416ALED6R.....ALL**  
6 Volt Red, offset pin. Replaces bulb  
#1154. 8.991 -0.2 ..... **\$10.00 EA** ⚠



**145416ALED6W.....ALL**  
6 Volt White, offset pin. Replaces bulb  
#1154. 8.991 -0.2 ..... **\$7.75 EA** ⚠



**145416J.....ALL**  
12V Amber, offset  
pins. Replaces bulb  
#1157. Use LED flasher  
#3713382L. 8.991 -0  
..... **CALL** ⚠



**145416K.....ALL**  
12v Amber, straight  
pins. Replaces bulb  
#1156. Use LED flasher  
#3713382L. 8.991 -0.15  
..... **\$12.25 EA** ⚠

**LED Bulbs, cont.**



**145416L.....ALL**  
12 Volt Red, offset pin. Replaces bulb  
#1157. Use LED flasher #3713382L.  
8.991 -0.15 ..... **\$13.00 EA** ⚠



**145416LED6A.....ALL**  
6V Amber, straight pins.  
single contact Replaces  
bulb #1156. 8.991 -0.15  
..... **\$14.00 EA** ⚠



**145416LED6R.....ALL**  
6 Volt Red, straight pin. Replaces bulb  
#1156. 8.991 -0.15 ..... **\$9.75 EA** ⚠



**145416LED6W.....ALL**  
6 Volt White, straight pin. Replaces bulb  
#1156. 8.991 -0.3 ..... **\$15.00 EA** ⚠

**145416LW.....ALL**  
12 Volt Red, offset pin. Replaces bulb  
#1157. Use LED flasher #3713382L.  
8.991 -0 ..... **CALL** ⚠



**145416M.....ALL**  
12 Volt Red, straight pin (single contact).  
Replaces bulb #1156. Use LED flasher  
#3713382L. 8.991 -0.3 ..... **\$23.25 EA** ⚠

**145416N.....ALL**  
12v Amber, straight pins. Replaces bulb  
#1156. Use LED flasher #3713382L.  
8.991 -0.15  
..... **\$15.00 EA** ⚠

**SECTION 100T  
RESTORATION PARTS**

**Headlight Bulbs**



**110185.....31-39**  
Headlight bulb. 6 volt.  
8.991-0.4  
..... **\$12.25 EA** ⚠

**Bulbs**



**115273.....ALL**  
High beam indicator &  
ignition lock lamp #51-  
6v. 8.991-0.4  
..... **\$2.25 EA** ⚠



**115273A.....ALL**  
High beam indicator &  
ignition lock lamp #53-  
12v. 8.991-0.15  
..... **\$0.50 EA** ⚠



**119294.....ALL**  
Dome & stop lamp  
#87-6v (1 contact) w/  
straight pins. 8.991-0.3  
..... **\$1.50 EA** ⚠



**119294A.....ALL**  
Dome & stop lamp  
#93-12v (1 contact) w/  
straight pins. 8.991-0.3  
..... **\$3.00 EA** ⚠



**119434.....ALL**  
Dome lamp #82-6v (2  
contacts). 8.991-0.4  
..... **\$1.75 EA** ⚠



**119434A.....ALL**  
Dome lamp #90-12v (2  
contacts). 8.991-0.3  
..... **\$1.75 EA** ⚠



**120406.....ALL**  
Dome lamp #88-6v (2  
contacts). 8.991-0.2  
..... **\$1.25 EA** ⚠



**120406A.....ALL**  
Dome lamp #94-12v (2  
contacts). 8.991-0.15  
..... **\$1.00 EA** ⚠



**125588.....ALL**  
Parking (in head lamp)  
instrument panel,  
clock, glove box, dome  
light, Cabriolet tail light  
indicator #55-6v. 8.991-0.3  
..... **\$1.00 EA** ⚠

**Bulbs, cont.**



**125588A.....ALL**  
Parking (in head lamp)  
instrument panel,  
clock, glove box, dome  
light, Cabriolet tail light  
indicator #57-12v. 8.991-0.3  
..... **\$1.00 EA** ⚠



**142303.....ALL**  
Tail light or license  
light. Fits some Sedan  
Delivery tail lights. #63-  
6v. 8.991-0.2  
..... **\$1.00 EA** ⚠



**142303A.....ALL**  
Tail light or license  
light. Fits some Sedan  
Delivery tail lights. #98-  
12v. 8.991-0.15  
..... **\$0.50 EA** ⚠



**142306.....ALL**  
Dome lamp (panel)  
#81-6v (1 contact).  
8.991-0.2  
..... **\$1.00 EA** ⚠



**142306A.....ALL**  
Dome lamp (panel)  
#89-12v (1 contact).  
8.991-0.2  
..... **\$1.00 EA** ⚠



**142309.....ALL**  
Fog, back up & safety  
light #1133-6v.  
8.991-0.15  
..... **\$1.50 EA** ⚠



**145416.....ALL**  
Tail light & stop light  
#1154-6v. 8.991-0.15  
..... **\$1.50 EA** ⚠



**145416A.....ALL**  
Tail light & stop light  
(bright) #1157-12v w/  
offset pins. 8.991-0.4  
..... **\$1.75 EA** ⚠



**145417.....ALL**  
Brake and turn signal.  
Dual element 6v w/  
equal height retaining  
pins. #1158. 8.991-0.3  
..... **\$2.25 EA** ⚠



**145419.....ALL**  
Brake and turn signal.  
Dual element 12v w/  
equal height retaining  
pins. #1176. 8.991-0.3  
..... **\$3.50 EA** ⚠



**145431.....ALL**  
Safety light-spotlight  
#1323-6v. 8.991-0.15  
..... **\$12.00 EA** ⚠

**Bulbs, cont.**



**453138.....ALL**  
Dome lamp #210-6v (2  
contacts). 8.991-0.15  
..... **\$2.75 EA** ⚠



**453138A.....ALL**  
Dome lamp #1004-12v  
(2 contacts). 8.991-0.15  
..... **\$1.50 EA** ⚠

**Spotlight**



**444279.....ALL**  
6 in. sealed beam, 6v,  
#4535. For Unity spot  
lights. 9.773-0.15  
..... **\$34.00 EA** ⚠



**451927.....ALL**  
5 in. sealed beam,  
12v, #4405 (fits unity  
spotlight only). For Unity  
spot lights. 9.773-0.2  
..... **\$24.00 EA** ⚠



**456720.....ALL**  
6 in. sealed beam, 12v,  
#4435. For Unity spot  
lights. 9.773-0.15  
..... **\$24.00 EA** ⚠



**987264.....ALL**  
5 in. sealed beam, 6v,  
#4515. For Unity spot  
lights. 9.773-0.3  
..... **\$34.00 EA** ⚠

**Driving Lights**



**3936674.....ALL**  
5 in. sealed beam.  
Clear, 6v, #4015. For  
Unity driving lights.  
9.774-0.2  
..... **\$39.00 EA** ⚠



**593837.....ALL**  
5 in. sealed beam.  
Clear, 12v, #4415. For  
Unity driving lights.  
9.774-0.3  
..... **\$28.39 EA** ⚠



**986942.....ALL**  
6 in. sealed beam.  
Clear, 6v, #4012. For  
Unity driving lights.  
9.774-0.2  
..... **\$38.59 EA** ⚠



**987263.....ALL**  
6 in. sealed beam.  
Clear, 12v, #4412. For  
Unity driving lights.  
9.774-0.15  
..... **\$24.00 EA** ⚠





**Fog Lights**



**3936674A.....ALL**  
5 in. sealed beam,  
amber, 6v, #4015A.  
For Unity fog lights.  
9.774 -0.15

..... **\$34.00 EA** ⚠



**593837A.....ALL**  
5 in. sealed beam,  
amber, 12v, #4415A.  
For Unity fog lights.  
9.774 -0.2

..... **\$25.00 EA** ⚠



**986942A.....ALL**  
6 in. sealed beam,  
amber, 6v, #4012A.  
For Unity fog lights.  
9.774 -0.15

..... **\$34.25 EA** ⚠

**986942N .....ALL**  
6 in. sealed beam, amber, 6v, #4012A.  
For Unity fog lights. NOS shelf worn.  
9.774 -0

..... **\$25.00 EA** ⚠



**987263A.....ALL**  
6 in. sealed beam,  
amber, 12v, #4412A.  
For Unity fog lights.  
9.774 -0.2

..... **\$34.00 EA** ⚠

100T

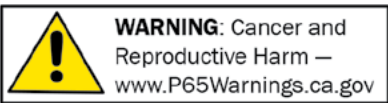

**WARNING:** Cancer and  
Reproductive Harm —  
www.P65Warnings.ca.gov

Chemicals shipped domestic ground only (Lower 48 states only). No international shipping.

**Phone: (360) 816-0211 • (800) 999-CHEV (2438) • www.chevsofthe40s.com**

**SECTION 110T  
STREET ROD PARTS**

**Bed Roll Light**



**MAK102853** .....41-66  
Chevy - Red. Incandescent bulb (amber also available). 0.000-0 . **\$86.00 PR** ⚠



**LEDBEDLITE** .....ALL  
LED tail light w/ Aluminum housing in 15/16" (red only), 1-1/8", 1-1/4" or 1-5/8" diameters. Choose Amber or Red. 12V 0.000-0 .. starting at **\$110.00 PR** ⚠



**MAK102864** .....ALL  
Red LEDs. Billet aluminum w/ polished bezel. Dual intensity for tail light and brake/ turn signal. Includes 10" pigtail. Fits 40-66 Chevy, 40-87 GMC. 12V. 1-19/32 hole. 0.000-0 . **\$148.00 PR** ⚠



**MAK102865** .....ALL  
19 Amber LEDs. 12V. 1-19/32 hole. 0.000-0 ..... **\$148.00 PR** ⚠

**Bed Roll Reflector**



**MAK102850**... 41-66  
red insert reflector.  
0.000-0.15  
..... **\$60.25 PR** ⚠

**LED Bed Roll Light -Reverse Light**



**MAK102866** .....ALL  
19 White LEDs for back up lights. 12V. 1-19/32 hole. 0.000-0 **\$160.00 PR** ⚠

**Blue Dots**



**920626A** .....ALL  
Glass w/ chrome ring (you install). 2.682-0.15 ..... **\$7.25 PR** ⚠



**920627A**.....ALL  
Chrome with amber Bowtie cut out. 2.682-0.15  
..... **\$22.19 PR** ⚠



**920627B**.....ALL  
Chrome with blue Bowtie cut out. 2.682-0

..... **CALL** ⚠

**SECTION 110T  
RESTORATION PARTS**

**1934-39 Tail Light**



**913823BD** .....31-35  
Taillight Lens (glass) W/bowtie 2.682-0  
**\$33.00 EA** ⚠



**363149**.....31-39  
Includes license light. 2.679-0.15 .....  
**\$111.00 EA** ⚠

**1934-39 Tail Light, cont.**



**913823** .....34-39  
Lens 2.682-0  
..... **\$11.50 EA** ⚠

**913823B** .....34-39  
Glass w/ Bowtie 2.682-0  
..... **\$18.50 EA** ⚠



**913824**.....34-39  
Gasket, lens. 2.684-0.2  
..... **\$5.00 EA** ⚠



**913825**.....34-39  
Rim. Chrome With Bowtie center. 2.681-0.15  
..... **\$48.00 EA** ⚠

**1940-53 Tail Light Assembly Black Housing**

Flat on Back



**927074GL**.....40-53  
Glass script lens, Black housing & chrome rim. Left side. 2.679-0.15 . **\$27.75 EA** ⚠



**985608GR** .....40-53  
Glass script lens, Black housing & chrome rim. Right side. 2.679-0 . **\$27.75 EA** ⚠

**1940-53 Tail Light Assembly Chrome Housing**



**927074CL**.....40-53  
Chrome w/ script glass lens. Left side. 2.679-0 ..... **\$37.50 EA** ⚠



**1940-53 Tail Light Assembly Chrome Housing, cont.**



**985608CR** .....40-53  
 Chrome w/ script glass lens. Right side.  
 2.679-0 ..... **\$34.00 EA** ⚠

**1940-53 Tail Light Assembly Blue Dot Black Housing**



**927074BL** .....40-53  
 W/ glass lens, blue dot, & license light.  
 Left side. 2.679-0.15 ..... **\$29.00 EA** ⚠



**985608BR** .....40-53  
 W/ glass lens & blue dot. Right side.  
 2.679-0 ..... **\$39.00 EA** ⚠

**1940-53 Tail Light Assembly Blue Dot Chrome Housing**



**927074DL** .....40-53  
 Glass lens w/ blue dot and chrome housing. Left side. 2.679-0.15 ..... **\$29.75 EA** ⚠



**985608DR** .....40-53  
 Chrome, glass w/ blue dot. Right side.  
 2.679-0 ..... **\$36.00 EA** ⚠

**1940-53 Tail Light Assembly Black Housing Plastic Lens**



**927074L** .....40-53  
 W/ plastic lens. Left side. 2.679-0 ..... **\$27.00 EA** ⚠



**985608R** .....40-53  
 W/ plastic lens, right. 2.679-0 ..... **\$27.75 EA** ⚠

**1940-53 Tail Light Assembly LED Black Housing**



**927074EL** .....40-53  
 Red LED tail light with black housing. White LED license light on bottom of housing. Left side. 12V 2.679-0 ..... **\$49.00 EA** ⚠



**985608ER** .....40-53  
 Red LED tail light with black housing. Right hand side. 12V 2.679-0 .. **\$39.00 EA** ⚠

**1940-53 Tail Light Assembly LED Stainless**



**927074FL** .....40-53  
 Red LED tail/ brake light with Stainless steel housing. Left side w/ white LED license light. 12V 2.679-0.15 ..... **\$59.75 EA** ⚠

**1940-53 Tail Light Assembly LED Stainless, cont.**



**985608FR** .....40-53  
 Red LED tail light with stainless steel housing. Right hand side. 12V 2.679-0.15 ..... **\$52.00 EA** ⚠

**1940-53 Tail Light Assembly LED Chrome Housing**



**927074HL** .....40-53  
 Red LED tail light with chrome housing. White LED license light on bottom of housing. Left side. 12V 2.679-0 ..... **\$54.00 EA** ⚠



**985608HR** .....40-53  
 Red LED tail light with chrome housing. Right hand side. 12V 2.679-0.15 ..... **\$47.00 EA** ⚠

**1940-53 Tail Light Lens Plastic**



**5937162** .....40-53  
 Tail light lens. Plastic, 4in. x 2-3/4in.  
 2.682-0.15 ..... **\$5.00 EA** ⚠



**WARNING:** Cancer and Reproductive Harm — [www.P65Warnings.ca.gov](http://www.P65Warnings.ca.gov)

Chemicals shipped domestic ground only (Lower 48 states only). No international shipping.

**Phone: (360) 816-0211 • (800) 999-CHEV (2438) • [www.chevsofthe40s.com](http://www.chevsofthe40s.com)**

**1940-53 Tail Light Lens Glass**



**920626.....40-53**  
Tail light lens. Original script, glass, 4in. x 2-3/4in. 2.682-0 ..... **\$5.50 EA** ⚠️

**1940-53 Tail Light Lens Blue Dot**



**920626B.....40-53**  
Tail light lens. Glass w/ blue dot, 4in. x 2-3/4in. 2.682-0 ..... **\$10.50 EA** ⚠️

**1940-53 Tail Light Lens LED**



**920626LL.....40-53**  
LED conversion. Tail light & license lens w/ integrated LED. LEFT. 12V (must splice wires) 2.682-0.15 ..... **\$39.00 EA** ⚠️



**920626LR.....40-53**  
LED conversion. Tail light w/ integrated LED. RIGHT. 12V (must splice wires) 2.682-0 ..... **\$29.00 EA** ⚠️



**920626LS.....40-53**  
LED conversion. Tail light & license lens w/ integrated LED and sequential turn signals. LEFT. 12V (must splice wires) 2.682-0 ..... **\$47.00 EA** ⚠️

**1940-53 Tail Light Lens LED, cont.**



**920626RS.....40-53**  
LED conversion. Tail light w/ integrated LED with sequential turn signals. RIGHT. 12V (must splice wires) 2.682-0 ..... **\$35.00 EA** ⚠️

**1940-53 Tail Light Lens Blue Dot LED**



**920626LLB.....40-53**  
LED conversion. Tail light & license lens w/ integrated LED w/ Blue Dot. LEFT. 12V (must splice wires) 2.682-0.15 ..... **\$47.75 EA** ⚠️

**920626LRB.....40-53**  
LED conversion. Blue Dot tail light w/ integrated LED. RIGHT. 12V (must splice wires) 2.682-0.15 ..... **\$39.75 EA** ⚠️

**1940-53 Tail Light Components**



**920626R.....37-53**  
Reflector. Brighten up tail light for improved safety. 2.682-0 ..... **CALL** ⚠️



**5933830.....40-53**  
Tail light rim, 4in. x 2-3/4in. 2.681-0.15 ..... **\$7.00 EA** ⚠️

**1940-53 Tail Light Components, cont.**



**920625.....40-53**  
Gasket, tail light lens, 4in. x 2-3/4in. 2.684-0.2 ..... **\$1.25 EA** ⚠️



**923315.....40-53**  
Screws for tail light rim. Stainless steel (2 pcs). 2.688-0.4 ..... **\$0.75 SET** ⚠️



**142303.....ALL**  
Tail light or license light. Fits some Sedan Delivery tail lights. #63-6v. 8.991-0.2 .. **\$1.00 EA** ⚠️



**142303A.....ALL**  
Tail light or license light. Fits some Sedan Delivery tail lights. #98-12v. 8.991-0.15 ..... **\$0.50 EA** ⚠️

**1947-53 Tail Light Assembly -Panel & Suburban (optional)**

Note: Tail light parts below fit Panels & Suburbans w/ 3in. O.D. round, bullet-shaped dual tail lights.



**916877.....47-53**  
Primered housing, red lens. 2.679-0.15 ..... **\$42.00 EA** ⚠️



**1947-53 Tail Light Assembly -Panel & Suburban (optional), cont.**



**916877C** .....47-53  
 Chrome housing, red lens. Fits left or right.  
 2.679-0 ..... **\$50.00 EA** ⚠️



**916877CLA** .....47-53  
 LED. Chrome housing w/ Amber lens. 12V  
 fits left or right 2.679-0 .. **\$80.00 EA** ⚠️



**916877CLAC** .....47-53  
 LED. Chrome housing w/ Amber LED &  
 clear lens. 12V fits left or right 2.679-0  
**\$80.00 EA** ⚠️



**916877CLR** .....47-53  
 LED. Chrome Left housing w/ Red lens left  
 side. 12V left side 2.679-0 .. **\$75.00 EA**  
 ⚠️

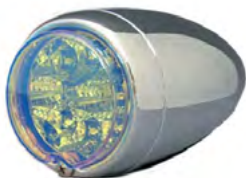

**916877CLRC** .....47-53  
 LED. Chrome housing w/ Clear lens & Red  
 LED. 12V fits left or right. 2.679-0 .....  
**\$80.00 EA** ⚠️

**1947-53 Tail Light Assembly -Panel & Suburban (optional), cont.**



**916877CRR** .....47-53  
 LED. Chrome right housing w/ Red lens.  
 12V right side 2.679-0 ... **\$75.00 EA** ⚠️



**916877LA** .....47-53  
 LED. Primed housing,  
 amber lens. 12V left or  
 right. 2.679-0  
 ..... **\$80.00 EA** ⚠️



**916877LAC** .....47-53  
 LED. Primed housing w/ Amber LED &  
 CLEAR lens. 12V first left or right 2.679-0  
 ..... **\$80.00 EA** ⚠️



**916877LR** .....47-53  
 LED. Primed housing w/ Red lens left.  
 12V left side 2.679-0 ..... **\$80.00 EA** ⚠️



**916877LRC** .....47-53  
 LED. Primed housing w/ Red LED &  
 clear lens. 12V fits left or right 2.679-0  
**\$80.00 EA** ⚠️



**916878LR** .....47-53  
 LED. Primed housing w/ Red lens right  
 side. 12V right side 2.679-0 ..... **\$80.00 EA**  
 ⚠️

**1947-53 Tail Light Components Panel & Suburban (optional), cont.**



**920696LLR** .....39-53  
 RED lens for 3" LED tail light. Fits 39-52  
 car or 47-53 trucks (fits LED units above  
 only). 2.682-0.15 ..... **\$2.00 EA** ⚠️



**916879** .....47-53  
 Pad-for 3in. round tail  
 lights (2 pcs) 2.660-0  
 ..... **\$18.00 PR** ⚠️



**920696** .....47-53  
 Lens, glass (Fits 3 in.  
 housing). 2.682-0.15  
 ..... **\$8.50 EA** ⚠️



**920696B** .....47-53  
 Lens, glass (Fits 3 in.  
 housing) w/ blue dot.  
 2.682-0  
 ..... **\$15.50 EA** ⚠️



**921872** .....47-53  
 Gasket, lens (3in. o.d.,  
 round) (2 pcs). 2.684-0.2  
 ..... **\$3.50 PR** ⚠️



**923322** .....47-53  
 Rim (3in. round).  
 2.681-0  
 ..... **\$7.00 EA** ⚠️

**1954 Tail Light Assembly**



**897711** ..... 54  
 Assembly. Black w/ boot & pigtail. Chevy &  
 GMC 2.679-0.15 ..... **\$41.00 EA** ⚠️



**897711C** ..... 54  
 Assembly. Stainless w/ boot & pigtail.  
 Chevy & GMC 2.679-0.15 ..... **\$52.75 EA** ⚠️



**WARNING:** Cancer and  
 Reproductive Harm —  
[www.P65Warnings.ca.gov](http://www.P65Warnings.ca.gov)

Chemicals shipped domestic ground only (Lower 48 states only). No international shipping.

**Phone: (360) 816-0211 • (800) 999-CHEV (2438) • www.chevsofthe40s.com**

110T

**1954 Tail Light**



**5938745** ..... 54  
 Lens, plastic w/ guide  
 script. Chevy & GMC  
 2.682-0.2  
 ..... **\$7.00 EA** ⚠



**914301** ..... 54  
 Gasket, lens. 2.684-0.15  
 ..... **\$3.50 EA** ⚠



**918355** ..... 54  
 Rim stainless steel.  
 Chevy & GMC 2.681-0.15  
 ..... **\$7.00 EA** ⚠

**Rubber Boot**



**5933167C** ..... 54-57  
 For tail light pigtail.  
 2.596-0.15  
 ..... **\$18.75 EA** ⚠

**Tail Light Pigtails**



**5291632** ..... 54-57  
 With bulb contacts.  
 2.694-0.15  
 ..... **\$7.00 EA** ⚠

**Tail Light Panel & Suburban**



**3676259** ..... 47-56  
 Pad (Panel, Suburban  
 w/ doors). 2.660-0.15  
 ..... **\$59.00 EA** ⚠



**5936905** ..... 47-56  
 Gasket, license lens  
 (Panel, Suburban w/  
 doors). 2.686-0.15  
 ..... **\$1.75 EA** ⚠



**5936906B** ..... 47-56  
 Glass lens w/ blue dot  
 (Panel, Suburban w/  
 doors). 2.682-0.15  
 ..... **\$27.00 EA** ⚠



**5936906BP** ..... 47-56  
 Plastic lens w/ blue dot  
 (Panel, Suburban w/  
 doors). 2.682-0.15  
 ..... **\$22.00 EA** ⚠



**5936907** ..... 47-56  
 Gasket, lens (Panel,  
 Suburban w/ doors).  
 2.684-0.2  
 ..... **\$5.00 EA** ⚠



**3686479** ..... 47-57  
 Pad, 4-1/2 in. round,  
 (Panel, Suburban w/  
 tailgate). 2.660-0.15  
 ..... **\$41.75 EA** ⚠

**Brake Light Contact**



**594904B** ..... 37-51  
 Rear door taillight  
 contacts Panel and  
 Suburban 2.447-0.15  
 ..... **\$69.75 EA** ⚠

**Tail Light Brackets**



**602534** ..... 34-39  
 Painted Left. Tail light & license plate.  
 2.662-0.15 ..... **\$39.75 EA** ⚠



**602535** ..... 34-39  
 Painted Right 2.662-0.15 ..... **\$37.75 EA** ⚠



**604235** ..... 40-46  
 Painted Right 2.662-0 ..... **\$45.00 EA** ⚠



**604293** ..... 40-46  
 Painted Left. Tail light & license plate.  
 2.662-0 ..... **\$50.00 EA** ⚠



**3696238D** ..... 47-53  
 Right, chrome. 2.662-0.15 ..... **\$19.25 EA**  
 ⚠

**Tail Light Brackets, cont.**



**3696238E** ..... 47-53  
 Painted Right 2.662-0.15 ..... **\$11.50 EA** ⚠



**3696238S** ..... 47-53  
 Right side. Stainless steel. 2.662-0.15  
 ..... **\$27.00 EA** ⚠



**3847441D** ..... 47-53  
 Left, tail light & license plate. Chrome.  
 2.662-0.15 ..... **\$14.00 EA** ⚠



**3847441E** ..... 47-53  
 Painted Left. Tail light & license plate.  
 2.662-0.15 ..... **\$12.00 EA** ⚠



**3847441S** ..... 47-53  
 Left side, tail light & license plate.  
 Stainless steel. 2.662-0.15 .. **\$27.00 EA**  
 ⚠



**2304056** ..... 54  
 Right, unpainted. Chevy & GMC 2.662-0.15  
 ..... **\$7.50 EA** ⚠



**Tail Light Brackets, cont.**



**2304056C** ..... **54**  
 Right, chrome. Chevy & GMC 2.662 -0.15  
 ..... **\$10.00 EA** ⚠️



**2304056S** ..... **54**  
 Right side. Stainless steel. Chevy & GMC  
 2.662 -0.15 ..... **\$14.50 EA** ⚠️



**2309105** ..... **54**  
 Left, unpainted. Chevy & GMC 2.662 -0.15  
 ..... **\$7.50 EA** ⚠️



**2309105C** ..... **54**  
 Left, chrome. Chevy & GMC 2.662 -0.15  
**\$10.00 EA** ⚠️



**2309105S** ..... **54**  
 Left side. Stainless steel. Chevy & GMC  
 2.662 -0.15 ..... **\$14.50 EA** ⚠️

**1940-53 License Light Lens**

**827925** ..... **40-53**  
 Retainer clips & screws,  
 license light lens.  
 2.691 -0.15  
 ..... **\$16.50 SET** ⚠️



**920634** ..... **40-53**  
 License light lens (glass). 2.685 -0.15  
**\$42.00 EA** ⚠️



**920634P** ..... **40-53**  
 License light lens (plastic). 2.685 -0.2  
**\$5.00 EA** ⚠️

**920808** ..... **40-53**  
 Gasket for license light  
 lens 2.686 -0.2  
 ..... **\$2.50 EA** ⚠️

**License Light Pad**

**3688071** ..... **54**  
 Pickup w/ rear bumper.  
 2.702 -0  
 ..... **\$14.50 PR** ⚠️

**Fog Light, Backup Light Switch**



**924160** ..... **ALL**  
 Fog light, backup light, etc, rotary. Clamps  
 to dash bottom. 9.774 -0.2  
**\$23.00 EA** ⚠️

**License Plate Bracket**



**3707021** ..... **54-59**  
 Pickup (w/ rear bumper) exc Suburban &  
 Panel. Includes license light rear.  
 2.705 -0.15 ..... **\$32.00 EA** ⚠️

**Wire Conduit**

**1842812A** ..... **31-39**  
 Retainer for galvanized  
 conduit. 2.646 -0.15  
 ..... **\$17.25 EA** ⚠️



**985608SCL** ..... **40-72**  
 19in. length, Stainless Steel line.  
 2.679 -0.15 ..... **\$10.75 PR** ⚠️

**985608SCS** ..... **47-54**  
 12in. length, Stainless  
 Steel line. 2.679 -0.2  
 ..... **\$16.50 PR** ⚠️

**Odds & Ends**

Please call for availability on all Odds & Ends  
 parts; once part is sold, it may no longer be in  
 stock.



**919044** ..... **47-57**  
 Lens (Panel/ Suburban  
 w/ tailgate) 4-3/16in.  
 O.D., round. (shelf worn)  
 2.682 -0  
 ..... **\$100.00 EA** ⚠️



**WARNING:** Cancer and  
 Reproductive Harm —  
[www.P65Warnings.ca.gov](http://www.P65Warnings.ca.gov)

Chemicals shipped domestic ground only (Lower 48 states only). No international shipping.

**Phone: (360) 816-0211 • (800) 999-CHEV (2438) • www.chevsofthe40s.com**

**SECTION 120T  
STREET ROD PARTS**

**Air Cleaner**



**OTB-4750.....ALL**  
Finned Unpolished Fits 2-1/4" Rochester, Carter, Zenith Carbs -0  
..... **\$153.00 EA** ⚠



**OTB-4750P ....ALL**  
Finned Polished Fits 2-1/4" Rochester, Carter, Zenith Carbs -0  
..... **\$169.50 EA** ⚠



**OTB-4760.....ALL**  
Ribbed Edge Unpolished Fits 2-1/4" Rochester, Carter, Zenith Carbs -0  
..... **\$153.00 EA** ⚠

**OTB-4760P.....ALL**  
Ribbed Edge Polished Fits 2-1/4" Rochester, Carter, Zenith Carbs -0  
..... **\$169.50 EA** ⚠



**OTB-4770.....ALL**  
Mini Mohawk Unpolished Fits 2-1/4" Rochester, Carter, Zenith Carbs -0  
..... **\$149.00 EA** ⚠



**OTB-4770P ....ALL**  
Mini Mohawk Polished Fits 2-1/4" Rochester, Carter, Zenith Carbs -0  
..... **\$169.50 EA** ⚠

**Fuel Fill Bowl Grommet**



**605238C.....ALL**  
Grommet for flush bed mounted fuel fill bowl. 3.001-0.15  
..... **\$7.00 EA** ⚠

**Fuel Fill Bowl**



**605238A.....ALL**  
Flush bed mount, stainless fuel fill bowl for under bed gas tank. 3.001-0.15  
..... **\$33.00 EA** ⚠

**Gas Cap**



**KUSC-312521.....ALL**  
Polished Billet Aluminum. 2-1/2" dia. Twist to pop open. -0.15  
..... **\$164.75 EA** ⚠

**Fenton Intake 2 Carb**



**838574B.....37-53**  
Heat kit. Split headers to intake. 216ci only. 3.640-0.2  
..... **\$44.25 EA** ⚠



**3687540B.....50-62**  
Install kit for Fenton intake manifold. Includes bellcrank, throttle rod & spring. 3.579-0.2  
..... **\$48.00 EA** ⚠



**3836071E.....50-62**  
2 carb intake kit. Includes linkage and fuel kit to install from existing fuel line. For 235ci & 261ci (261ci uses 235ci carbs, w/ 2-15/16" bolt spacing). No grinding required to fit headers. 3.265-0.15  
..... **\$215.00 EA** ⚠



**838573B.....50-62**  
Heat kit. Split headers to intake. 235ci only. 3.640-0.2  
..... **\$44.25 EA** ⚠

**Offenhauser Intake 2 Carb**



**3836071B.....37-53**  
Dual carb. Fits 216ci. Uses 216ci carbs with 2-5/8in. bolt spacing. Linkage included (carb only!). 3.265-0.15  
..... **\$326.00 SET** ⚠

**Offenhauser Intake 2 Carb, cont.**

**3836071A.....50-62**  
Dual carb. Fits 235ci. 261ci uses 235ci carbs with 2-15/16in. bolt spacing. Linkage included (carb only!). 3.265-0.15  
..... **\$428.00 SET** ⚠

**Offenhauser Intake 3 Carb**



**3836071D.....37-53**  
Triple carb. Fits 216ci. Uses 216ci carbs with 2-5/8in. bolt spacing. Linkage included (carb only). 3.265-0.15  
..... **\$325.00 SET** ⚠

**3836071C.....50-62**  
Triple carb. Fits 235ci. 261ci uses 235ci carbs with 2-15/16in. bolt spacing. Linkage included (carb-only). 3.265-0.15  
..... **\$330.00 SET** ⚠

**Air Cleaner Assembly**



**1528725L.....ALL**  
Louvered. Complete w/ 4in. filter and base clamp. 3.410-0  
..... **\$12.75 EA** ⚠



**1528725ML.....ALL**  
Complete with 4in. filter, chrome louvered housing, base clamp & 3 prong spinner. Smooth housing. 2-5/8in. neck. 3.410-0.15  
..... **\$24.25 EA** ⚠



**1528725MS.....ALL**  
Complete with 4in. filter, base clamp & 3 prong spinner. Smooth housing. 2-5/8in. neck. 3.410-0.15  
..... **\$18.50 EA** ⚠



**1528725S.....ALL**  
Smooth. Complete w/ 4in. filter and base clamp. 3.410-0  
..... **\$12.75 EA** ⚠



# Section 120T: Fuel System, Gas Tanks, Gas Tank Sending Units, Fuel Pumps, Carburetors, Air Cleaners & Intake Manifolds

## Air Cleaner Assembly, cont.



**AIR95.....ALL**  
Stellings & Hellings  
9-1/2" dia. Stainless  
steel. Complete  
w/ filter and base  
clamp. Fits carbs  
with 2-1/4" top.  
3.410 -0

..... **CALL** ⚠

## Air Cleaner Adapter



**1528725A.....ALL**  
2-5/8in. to 2-5/16in  
to fit air cleaners.  
3.410 -0.15

..... **\$1.50 EA** ⚠

## Air Filter Element



**1528725E.....ALL**  
4 in. replacement for air cleaner  
assemblies (#1528725S, 1528725L,  
1528725ML and 1528725MS). 3.410 -0.2

..... **\$8.75 EA** ⚠



**AIR95F.....ALL**  
Replacement Air Filter  
For AIR95 3.410 -0.15

..... **\$16.75 EA** ⚠

## Air Cleaner Clamp



**1528725C.....ALL**  
Replacement for base  
of 4in. air cleaner  
(#1528725S &  
#1528725L). 3.410 -0.15

..... **\$1.00 EA** ⚠

## Line Clamp Stainless

Lokar Line Clamps are stainless steel and come with machine and sheetmetal screws. For securing electric, brake, fuel or transmission lines.



**13274.....ALL**  
3/16" single (12 clamps). 8.950 -0.15

..... **\$18.25 SET** ⚠

## Line Clamp Stainless, cont.

**13275.....ALL**  
3/16" x 3/8" double combination (6  
clamps). 8.950 -0.15

..... **\$18.00 SET** ⚠

**13276.....ALL**  
3/16" x 3/16" double (6 clamps).  
8.950 -0.15

..... **\$18.00 SET** ⚠

**13277.....ALL**  
1/4" single (12 clamps). 8.950 -0.15

..... **\$18.00 SET** ⚠

**13278.....ALL**  
5/16" single (12 clamps). 8.950 -0.15

..... **\$18.00 SET** ⚠

**13279.....ALL**  
3/8" single (12 clamps). 8.950 -0.15

..... **\$18.00 SET** ⚠

**13280.....ALL**  
1/2" single (12 clamps). 8.950 -0.15

..... **\$18.00 SET** ⚠

**13281.....ALL**  
5/8" single (8 clamps). 8.950 -0.15

..... **\$18.00 SET** ⚠

**13282.....ALL**  
3/4" single (8 clamps). 8.950 -0.15

..... **\$18.00 SET** ⚠

**13283.....ALL**  
7/8" single (8 clamps). 8.950 -0.15

..... **\$18.00 SET** ⚠

**13284.....ALL**  
5/16" x 3/8" double combination (6  
clamps). 8.950 -0.15

..... **\$18.00 SET** ⚠



**13285.....ALL**  
1/4" x 1/4" double (6 clamps). 8.950 -0.15

..... **\$18.00 SET** ⚠

**13286.....ALL**  
5/16" x 5/16" double (6 clamps).  
8.950 -0.15

..... **\$18.00 SET** ⚠

**13287.....ALL**  
3/8" x 3/8" double (6 clamps). 8.950 -0.15

..... **\$18.00 SET** ⚠

**13288.....ALL**  
1/2" x 1/2" double (6 clamps). 8.950 -0.15

..... **\$18.00 SET** ⚠

**13289.....ALL**  
5/8" x 5/8" double (4 clamps). 8.950 -0.15

..... **\$18.00 SET** ⚠

## Line Clamp Stainless, cont.

**13290.....ALL**  
3/4" x 3/4" double (4 clamps). 8.950 -0.15

..... **\$18.00 SET** ⚠

**13291.....ALL**  
7/8" x 7/8" double (4 clamps). 8.950 -0.15

..... **\$18.00 SET** ⚠

## Clamp



**120521.....ALL**  
1/4 in. bolt-on strap.  
For wire or tube (4 pcs).  
8.950 -0.4

..... **\$2.59 SET** ⚠



**120521A.....ALL**  
5/16 in, insulated bolt-  
on strap. For wire or  
tube (4 pcs). 8.950 -0.4

..... **\$3.29 SET** ⚠



**120521B.....ALL**  
3/8 in. bolt-on strap.  
For wire or tube (4 pcs).  
8.950 -0.4

..... **\$3.25 SET** ⚠

## Voltage Reducer



2.500 -0.15

**1119004.....ALL**  
Reducer 12v to 6v. Best  
for fuel gauge. Hi-Tech  
w/ constant volts.

..... **\$20.25 EA** ⚠

## Fuel Stabilizer

Keep fuel fresh. Removes water, cleans carburetors & fuel injectors. Protects engine from gum, varnish, rust, and corrosion. Eliminates need to drain fuel before storage. Special dispenser bottles measure exactly without waste. Contains NO alcohol.



**111801.....ALL**  
STA-BIL stabilizer. 8 oz  
bottle treats 20 gallons,  
for one year. 3.001 -0

..... **\$8.25 EA** ⚠



**111801B.....ALL**  
STA-BIL fuel stabilizer.  
32 oz bottle treats 80  
gallons, for one year.  
3.001 -0.15

..... **\$21.00 EA** ⚠

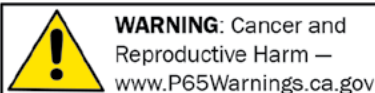

Chemicals shipped domestic ground only (Lower 48 states only). No international shipping.

Phone: (360) 816-0211 • (800) 999-CHEV (2438) • www.chevsofthe40s.com

120T

# Section 120T: Fuel System, Gas Tanks, Gas Tank Sending Units, Fuel Pumps, Carburetors, Air Cleaners & Intake Manifolds

## Gas Tank Restoration Kit



**PORTANK** .....ALL  
Portank, Restore your tanks. Cleaner, metal prep, sealer (Slosh) and instructions. 3.001-0.15 **\$89.00 KIT** ⚠

## Metal Prep



**PORMETAL** ....ALL  
Etches Metal and Leaves a Zinc Phosphate Coating. Provides the best adhesion for POR-15 on any metal surface. Water based,

OSHA approved biodegradable solution. 3.001-0.15

..... **\$16.99 QT** ⚠

## Gas Tank Cleaner



**PORCLEAN** ....ALL  
1 quart. MARINE-CLEAN cleans and degreases in one application without leaving residues, noxious fumes or flammable solvents. It makes petroleum-

based cleaners almost obsolete because it can be diluted with water up to 3, 4, 5 and even 10 times its volume while remaining more potent than other cleaners. 3.001-0.15

..... **\$13.25 EA** ⚠

## Gas Tank Sealer



**3657942C** .....ALL  
Gas tank sealer slosh, seals gas tank. Alcohol and Ethanol proof. Not for use with (MEK)

Methyl Ethyl Ketone. 3.001-0.15

..... **\$32.25 QT** ⚠

## Gas Tank Straps



**3658213A** .....ALL  
Universal, no hardware included. 42" L x 1-3/8" W. 3.022-0.15

..... **\$18.50 PR** ⚠

## SECTION 120T RESTORATION PARTS

### Main Fuel Line

Oversize shipping charges apply. Please call for rate.



product varies by vehicle

**348753** .....**37-54**  
Steel (specify year when ordering). Pre-bent. 8.964-0

..... **starting at \$60.00 SET** ⚠



product varies by vehicle

**348753S** .....**37-54**  
Stainless (specify year when ordering). Pre-bent. 8.964-0.4

..... **starting at \$55.00 SET** ⚠

### Fuel Pump to Carb Fuel Line

Oversize shipping charges apply. Please call for rate.



**348754** .....**ALL**  
Pre bent - Steel (specify year when ordering). 8.964-0.15

..... **starting at \$20.00 SET** ⚠



**348754S** .....**ALL**  
Pre bent Stainless (specify year when ordering). 8.964-0.15

..... **starting at \$25.00 SET** ⚠

### Electric Fuel Pump



..... **\$226.00 EA** ⚠

**5592627E** ....**ALL**  
Fuel will flow through pump when turned off so pump can be used just to prime or full

time. Inline, 6 volt. (30 GPH, 4-6 PSI). 3.900-0.15

..... **\$226.00 EA** ⚠



**5593256E** .....**ALL**  
Fuel will flow through pump when turned off so pump can be used just to prime or full

time. Inline, 12 volt. (30 GPH, 4-6 PSI). 3.900-0.15

..... **\$50.00 EA** ⚠



**5593256F** .....**ALL**  
Intank 12v electric fuel pump rated at 15 GPH and max 3 PSI. 3.900-0.15

..... **\$68.00 EA** ⚠



**5593256G** .....**ALL**  
Intank 12v electric fuel pump rated at 20-35 GPH and 4-6 PSI. 3.900-0.15

..... **\$73.00 EA** ⚠

## Electric Fuel Pump, cont.



**5593256H** .....**ALL**  
Intank 12v electric fuel pump rated at 20-35 GPH and 3-5 PSI. 3.900-0.15

..... **\$71.00 EA** ⚠

## Air Filter Element

Note: Air Filter Decals see Section 550T.



**1529264** .....**37-54**  
Complete. 6" OD. 4.5" ID. 1.375 Tall 3.410-0.15

..... **\$30.00 EA** ⚠



**1529264A** .....**37-54**  
Copper mesh only. 3.410-0.15

..... **\$15.25 EA** ⚠

## Wing Nut



**120240** .....**37-54**  
Air filter wing nut 8.920-0.4

..... **\$1.50 EA** ⚠

## Gas Tank Die Stamped

Oversize shipping charges apply to all Gas Tanks. Please call for rate.



**3657515** .....**39-46**  
Steel, as original. Under seat mount. 18 gallons (3 larger than original). For commercial only. 3.001-0.15

..... **\$521.50 EA** ⚠



# Section 120T: Fuel System, Gas Tanks, Gas Tank Sending Units, Fuel Pumps, Carburetors, Air Cleaners & Intake Manifolds

## Gas Tank Die Stamped, cont.

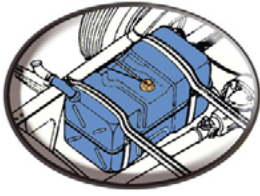

**3708924** .....47-55  
Steel, as original. Fits 47-48 1/2Ton, 49-55 Panel, Suburban & Canopy Express. 13" wide x 24" long (plus 5/8" flange) x 13-1/2" tall. 18 gallons. 3.001-0 .....  
**\$382.75 EA** ⚠



**3708971** .....49-54  
Behind seat, galvanized (as original). 17 gallons. 3.001-0.15 .....  
**\$201.50 EA** ⚠

## Gas Tank - Under Bed

Oversize shipping charges apply to all Gas Tanks. Please call for rate.

**3692400** .....47-53  
Stainless steel w/ anti slosh baffle. Fits 47-48 1/2Ton truck & 47-54 1/2Ton Panel. Holds 13.5 gallons. 23-3/4" L x 12-1/2" W x 13" H. 3.001-0 .....  
**\$895.00 EA** ⚠



**3847690** .....47-53  
Under bed, frame rail mount. Bed fill tank with baffles. 19 gallons. 3.001-0.15 .....  
**\$374.00 EA** ⚠



**3708964** .....54-55  
Under bed, frame rail mount. Bed fill tank with baffles. 19 gallons. -0.15 .....  
**\$374.00 EA** ⚠

## Gas Tank - Under Bed



**605238** .....ALL  
Polyethylene w/ straps. Fits under bed. Universal mount with 3in. neck. 22in. x 17in. x 9.5in. Holds 14 gallons. 3.001-0.15 .....  
**\$259.00 EA** ⚠



**605239** .....ALL  
Fits under bed. Universal mount. 27.75in. x 17.75in. x 8.5in. Holds 16 gallons (strap included). -0.15 .....  
**\$292.00 EA** ⚠

## Gas Tank Straps



**476972** .....37-46  
Tank straps. 3.001-0.15 ..  
**\$67.75 PR** ⚠



**3693463B** .....47-55  
Tanks straps. Fits 47-48 1/2 ton, 49-54 Panel, Suburban & Canopy Express. 3.022-0.15 .....  
**\$40.00 PR** ⚠



**3690133B** .....49-55  
With straps. For tanks behind the seat. 3.022-0.15 .....  
**\$106.75 PR** ⚠

## Gas Tank Mounting Pad

**3690131** .....39-46  
4 pieces. 3.015-0.15 .....  
**\$13.00 SET** ⚠



## Gas Tank Mounting Pad



**3690131B** .....47-54  
Gas tank bumper & grommet kit (8 pcs). 3.015-0.15 .....  
**\$13.50 SET** ⚠

## Gas Tank Sending Unit

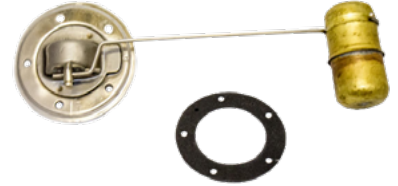

**1516287** .....34-46  
0-30 ohms for Chevy gauges (6v or 12v). 3.107-0.15 .....  
**\$46.75 EA** ⚠



**1515466** .....47-53  
0-30 ohms for Chevy gauges (6v or 12v). Brass float. Fits tanks behind the seat. 3.107-0.15 .....  
**\$37.00 EA** ⚠

**1517952** .....54-55  
0-30 ohms for Chevy gauges (6v or 12v). Brass float. 3.107-0.15 .....  
**\$46.75 EA** ⚠

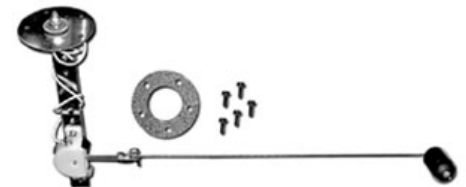

**1516250** .....ALL  
GM up to 1964 W/ screws, gasket & instructions, correct ohms (0-30) for early GM gauges, up to 1964 (6v or 12v). Adjustable float (plastic) height. 3.107-0.15 .....  
**\$25.00 EA** ⚠

## Float

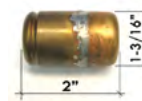

**3708954** .....47-59  
Brass, for gas tank sending unit. 3.107-0.15 .....  
**\$7.00 EA** ⚠



**1516250A** .....ALL  
Cork. For gas tank sending unit (2 floats). 3.107-0.15 .....  
**\$7.50 SET** ⚠

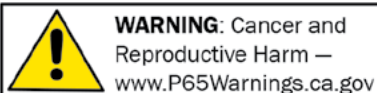

Chemicals shipped domestic ground only (Lower 48 states only). No international shipping.

Phone: (360) 816-0211 • (800) 999-CHEV (2438) • www.chevsofthe40s.com

120T

# Section 120T: Fuel System, Gas Tanks, Gas Tank Sending Units, Fuel Pumps, Carburetors, Air Cleaners & Intake Manifolds

## Float, cont.



**1516250R** .....ALL  
Plastic. For gas tank sending unit (2 floats).  
3.107 -0.15  
..... **\$9.75 PR** ⚠

## Gas Gauge Wire Grommet



**3653742** .....51-54  
Gas gauge wire,  
1/8in. I.D. X 1in. O.D.  
9.775 -0.15  
..... **\$5.75 EA** ⚠

## Terminal Boot



**1516252** .....ALL  
Sending unit wire boot.  
3.107 -0.15  
..... **\$26.50 EA** ⚠

## Gas Tank Sending Unit Gasket



**1516061** .....31-54  
Cork gasket, gas tank sending unit 3.112 -0.3

..... **\$2.25 EA** ⚠



**1516061R** .....31-54  
Rubber gasket, gas tank sending unit 3.112 -0.15

..... **\$2.25 EA** ⚠

## Screws



**1516061A** .....ALL  
Screws for sending unit (zinc). 3.112 -0.4  
..... **\$7.00 SET** ⚠

## Gas Shut Off Valve



**3681215** .....49-54  
Gas tank shut off valve - connects tank to intermediate fuel line 3.107 -0.15  
..... **\$45.25 EA** ⚠

## Intermediate Fuel Line

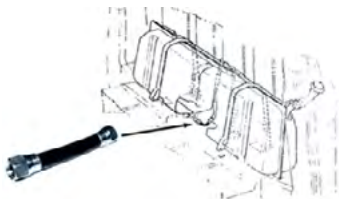

**3711160** .....49-54  
Intermediate line between main line and sending unit at tank. 7" length. 3.107 -0.15  
..... **\$18.75 EA** ⚠

## Gas Filler Neck Delete



**4754GD** .....47-54  
Metal filler panel to patch the hole from the filler neck if you have relocated your gas

tank. -0

..... **\$15.00 EA** ⚠

## Gas Tank Fill Hose Kit



**3684410** .....49-57  
Kit comes complete with hoses, clamps, neck, cap & grommet. 3.003 -0.15  
..... **\$54.75 SET** ⚠



**3684410C** .....49-57  
CHROME. Kit comes complete with hoses, clamps, neck, cap & grommet. 3.003 -0.15  
..... **\$84.75 SET** ⚠

## Fuel Filler Neck



**3684410F** .....47-48  
47-48 1/2Ton. 3.003 -0  
..... **CALL** ⚠

## Fuel Line Hose



**609742** .....ALL  
1/2" I.D. Sold by the inch 3.003 -0.3  
..... **\$0.25 IN** ⚠

## Gas Filler Hose Clamp



**3834073B** .....37-57  
For 2-1/4 in. I.D. gas filler hose, original. Fits Panel, Suburban, Bus & 37-46 exc COE (2 pcs). 3.003 -0  
..... **\$4.00 SET** ⚠



**111619** .....49-57  
For 1-7/8 in. I.D. gas filler hose. Original, conventional cab (2 pcs). 1.166 -0  
..... **\$4.50 SET** ⚠

## Gas Tank Filler Hose



**3654570** .....37-48  
GM script with clamps exc COE. 3.003 -0.2  
..... **\$11.25 SET** ⚠

**3654570** .....49-57  
GM script with clamps (panel, suburban & school bus chassis). 3.003 -0.2  
..... **\$12.25 SET** ⚠

**3692531** .....49-57  
Filler & vent hose GM script w/ clamps (conventional cab). 3.003 -0.2  
..... **\$11.50 SET** ⚠

## Gas Filler Grommet

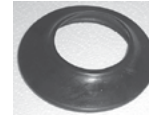

**598847** .....38-46  
Rubber. 42-46 also use pad #3674211 (below). Except suburban  
3.008 -0.15

..... **\$15.00 EA** ⚠

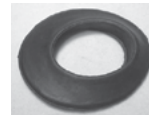

**3800461** .....39-46  
Panel & Suburban.  
3.008 -0.15

..... **\$15.00 EA** ⚠

Returns require a return authorization number—call first. • Product pricing & availability subject to change.



# Section 120T: Fuel System, Gas Tanks, Gas Tank Sending Units, Fuel Pumps, Carburetors, Air Cleaners & Intake Manifolds

## Gas Filler Grommet, cont.



**3674211.....42-46**  
Flange, held by 4 screws & metal retainer. Use with grommet #598847 (above).

3.008 -0.15

..... **\$12.00 EA** ⚠



**3606433.....47-48**  
Fits in right bedside. 3.008 -0.15

..... **\$11.25 EA** ⚠



**3807278.....47-54**  
Panel & Suburban. 3.008 -0.2

..... **\$11.25 EA** ⚠



**3807281.....49-54**  
Exc. Panel & Suburban. 3.008 -0.2

..... **\$10.75 EA** ⚠

## Gas Caps



**595857.....28-57**  
Non-locking, polished stainless steel (as original), w/ inside flange. (28-52 Car 28-57 Truck) 3.028 -0.15 ... **\$9.00 EA** ⚠

**595857C.....28-57**  
Non-locking, Show Quality Chrome (as original), w/ inside flange. (28-52 Car 28-57 Truck) 3.028 -0 ... **\$12.00 EA** ⚠



**595857L.....28-57**  
Locking, chrome w/ inside flange. Not original item. (28-52 Cars, 28-57 Trucks) 3.028 -0.15 ... **\$19.50 EA** ⚠



**985076.....38-57**  
Original "GM" locking gas cap. With GM logo. (28-52 Car 28-57 Truck) 3.028 -0.15

..... **\$51.25 EA** ⚠

## Gas Caps, cont.



**985076A.....38-57**  
Locking with Bowtie. Inside flange. (28-52 Car 28-57 Truck) 3.028 -0.15 **\$43.75 EA** ⚠

## Fuel Filter



**5451937.....33-56**  
Replacement element (not for fuel pump filter). 3.890 -0.15

..... **\$6.00 EA** ⚠



**986640.....33-56**  
Complete assembly w/ glass bowl and filter. 3.890 -0

..... **\$27.00 EA** ⚠



**986640LAC..33-56**  
Genuine AC. Complete assembly w/ glass bowl & filter. 3.890 -0.15

..... **\$38.50 EA** ⚠

## In Line Filter Bowl Gasket



**5452822.....37-57**  
Gasket, inline filter bowl. 2-7/64" 3.890 -0.2

..... **\$2.00 EA** ⚠

## Fuel Pump Gasket



**5590039.....37-56**  
Fuel pump filter bowl gasket, 2-1/4in. o.d. 3.904 -0.3

..... **\$2.75 EA** ⚠

## Fuel Pump Mounting Gasket



**838263.....37-57**  
Fuel pump mounting gasket 3.932 -0.15

..... **\$1.50 EA** ⚠

## Glass Bowl



**1523094.....37-55**  
Fuel pump (1-15/16" I.D., 2-1/4" O.D.) w/ gasket 3.903 -0.15

..... **\$18.50 SET** ⚠

## Fuel Pump



**1523429....37-51**  
W/ glass bowl, includes gasket. 3.900 -0.15

..... **\$99.00 EA** ⚠



**5591457...37-51**  
W/ vacuum pump (glass bowl) stops slow wipers, original accessory. Also fits GMC, includes gasket. 3.900 -0.15

..... **CALL** ⚠



**5591457M..37-51**  
W/ vacuum pump (metal bowl) includes gasket. 3.900 -0

..... **CALL** ⚠

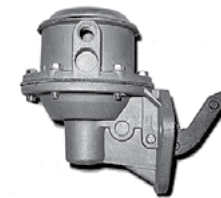

**5592627...37-51**  
W/ metal bowl, includes gasket. 3.900 -0

..... **CALL** ⚠



**5592627G...52-57**  
W/ glass bowl, includes gasket. 3.900 -0.15

..... **CALL** ⚠



**5592627M..52-57**  
W/ metal bowl, includes gasket. 3.900 -0

..... **CALL** ⚠

# Section 120T: Fuel System, Gas Tanks, Gas Tank Sending Units, Fuel Pumps, Carburetors, Air Cleaners & Intake Manifolds

## Fuel Pump, cont.



**5592675 . . . . .52-57**  
W/ vacuum pump (glass bowl) stops slow wipers, original accessory. 3.900 -0.15

..... **CALL** ⚠



**5592675M . . .52-57**  
W/ vacuum pump (metal bowl) stops slow wipers, original accessory. 3.900 -0

..... **CALL** ⚠

## Fuel Pump Rebuild Kit



**5591844 . . . . .37-51**  
W/ vacuum pump 3.901 -0.15  
.....  
**\$89.00 EA** ⚠



**5592945 . . . . .37-51**  
Without vacuum pump 3.901 -0.15  
.....  
**\$64.75 EA** ⚠



**5591825 . . . . .52-57**  
W/ vacuum pump 3.900 -0  
.....  
**\$77.25 EA** ⚠



**5592988 . . . . .52-57**  
Without vacuum pump 3.901 -0.15  
.....  
**\$64.75 EA** ⚠

## Carburetor

All carburetors are rebuilt units. Base gaskets are included.  
Core returns must be same style as purchased unit.



**838938 . . . . .37-40**  
Carter W-1 (\$150 core) 3.725 -0.15  
..... **\$190.50 EA** ⚠



**839987 . . . . .41-48**  
Carter W-1 (\$150 core) 3.725 -0.15  
..... **\$190.50 EA** ⚠



**3692429C . . . . .49**  
Carter W-1 (\$150 core). 3.725 -0.15  
..... **\$190.50 EA** ⚠



**7004600 . . . . .49-53**  
Rochester. Fits 216ci (\$150 core) 3.725 -0.15  
..... **\$190.50 EA** ⚠



**7004468 . . . . .50-59**  
Rochester. Fits 235ci (\$150 core). 3.725 -0.15  
..... **\$190.00 EA** ⚠

## Carburetor, cont.



**838939 . . . . .ALL**  
New universal carb. Fits 216,235,261ci engines. -0.15  
..... **\$359.50 EA** ⚠

## Carburetor Rebuild Service

**CARBREBUILD . . . . .ALL**  
Send in your carburetor to have rebuilt. Carter W-1, YF and Rochester model B single barrels. 3.725 -0.15  
..... **\$190.00 EA** ⚠

## Matched Rebuilt Carbs

**MATCHEDCARBS . . . . .ALL**  
Matched rebuilt carburetors for when ordering for a multi carb setup (\$150 core per carb) 3.725 -0.15  
..... **\$190.00 EA** ⚠

## Carburetor Cleaner



**6505259 . . . . .ALL**  
Gumout, 16 oz spray can. Cleans carburetors, linkage, choke valves and unpainted metal parts. 3.725 -0.15  
..... **\$7.75 EA** ⚠

## Carburetor Rebuild Kit



**7004363 . . . . .32-62**  
Rochester, fits 1 barrel models B, BC, BV 3.725 -0.15  
..... **\$40.50 EA** ⚠



**603978 . . . . .36-40**  
Fits Carter W-1, 216ci engine 3.725 -0.15  
..... **\$54.25 EA** ⚠

Returns require a return authorization number—call first. • Product pricing & availability subject to change.

100 Phone: (360) 816-0211 • (800) 999-CHEV (2438) • www.chevsofthe40s.com

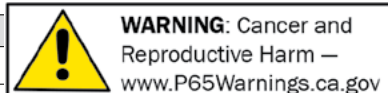

# Section 120T: Fuel System, Gas Tanks, Gas Tank Sending Units, Fuel Pumps, Carburetors, Air Cleaners & Intake Manifolds

## Carburetor Rebuild Kit, cont.



**3902169C** ..... **37-56**  
Fits Carter Y-F, 216ci 3.725 -0.15 .....  
**\$34.75 EA** ⚠



**609993** ..... **41-48**  
Carter W-1 (216ci) 3.725 -0.15 .....  
**\$48.75 EA** ⚠



**3692429** ..... **49**  
Carter W-1 3.725 -0.15 ..... **\$48.75 EA** ⚠

## Carburetor Parts



**839509A** ..... **33-49**  
Oversized throttle shaft for W-1 carburetor  
only 3.752 -0.15 ..... **\$42.25 EA** ⚠



**836636** ..... **37-49**  
Carburetor float Carter W-1 3.725 -0.15  
**\$49.25 EA** ⚠

**7002672** ..... **37-57**  
Carburetor float  
Rochester 3.745 -0.15



..... **\$21.50 EA** ⚠

## Carburetor Parts, cont.



**7002082A** ..... **49-60**  
Oversized throttle shaft for Rochester  
carburetor only 3.752 -0.15 .. **\$42.25 EA**  
⚠

## Carburetor Insulator



**3692797** ..... **34-53**  
Bakelite exc 50-53  
235ci. 2-11/16".  
3.726 -0.2  
..... **\$10.00 EA** ⚠



**3692797** ..... **39-55**  
Bakelite insulator  
(GMC). 3.726 -0  
..... **\$9.99 EA** ⚠



**3692799** ..... **50-59**  
Bakelite (235ci).  
2-15/16". 3.726 -0.2  
..... **\$11.75 EA** ⚠

## Carburetor Base Gasket



**601348** ..... **34-49**  
Carter W-1 base gasket  
2-11/16 inch bolt  
centers. 3.726 -0.2  
..... **\$2.75 EA** ⚠



**839632** ..... **50-53**  
216ci engine. 2-11/16  
inch bolt centers.  
3.726 -0.15  
..... **\$5.00 EA** ⚠



**3712549** ..... **50-62**  
Carburetor base (235ci,  
261ci engine). 3inch  
bolt centers. 3.726 -0.2  
..... **\$3.75 EA** ⚠

## Throttle Lever Stud



**838420** ..... **37-47**  
Throttle lever stud mounted to left side of  
engine block 3.582 -0.15 ..... **\$25.50 EA**  
⚠

## Throttle Return Spring



**3650230** ..... **37-40**  
Throttle return spring 3.459 -0.15 ...  
**\$5.00 EA** ⚠



**3659431** ..... **41-49**  
Throttle return spring 3.459 -0.15 ...  
**\$9.25 EA** ⚠



**3695705** ..... **50-59**  
All 6 cylinder. 3.459 -0 ..... **\$4.00 EA** ⚠

## Vacuum Advance Line

Oversize shipping charges apply. Please call  
for rate.



**217278** ..... **ALL**  
Pre bent. Carb to  
distributor. Steel  
(specify year when  
ordering). 8.964 -0.15



..... starting at **\$20.00 SET** ⚠  
**217278S** ..... **ALL**  
Pre bent. Carb to  
distributor. Stainless  
(specify year when  
ordering). 8.964 -0.15



..... starting at **\$25.00 SET** ⚠

## Gas & Fuel Line Clip



**148129A** ..... **ALL**  
Double ended, holds  
1/4in. brake & 5/16 in.  
gas line to frame (snaps  
into hole). 8.950 -0.4  
..... **\$5.00 EA** ⚠



**3735074C** ..... **ALL**  
3/8 in. slot, gas, brake  
line, wire harness (4  
pcs). 8.950 -0.15  
..... **\$6.50 SET** ⚠



**599119** ..... **ALL**  
Holds gas & vacuum  
lines together, fuel  
pump to carburetor

(uses 4) 8.950 -0.4

..... **\$6.00 PR** ⚠



**WARNING:** Cancer and  
Reproductive Harm —  
www.P65Warnings.ca.gov

Chemicals shipped domestic ground only (Lower 48 states only). No international shipping.

Phone: (360) 816-0211 • (800) 999-CHEV (2438) • www.chevsofthe40s.com

# Section 120T: Fuel System, Gas Tanks, Gas Tank Sending Units, Fuel Pumps, Carburetors, Air Cleaners & Intake Manifolds

## Manifold Gasket



**602483A.....37-53**

Intake & exhaust manifold. Fits 216ci

(3pcs) 3.270 -0.15

**\$18.50 SET** ⚠



**838290.....37-53**

Rectangle between manifolds. Fits 216ci  
3.272 -0.15

**\$6.25 EA** ⚠



**3707045.....50-62**

Intake & exhaust manifold. Fits 235ci & 261ci (3pcs) 3.270 -0.15

**\$17.50 SET** ⚠



**8385572.....50-62**

Rectangle between manifolds. Fits 235ci & 261ci 3.272 -0.15

**\$7.50 EA** ⚠

## Manifold Clamps & Bolts



**838546B.....37-57**

Intake - Exhaust manifold clamps (spreaders). Cast reproduction. 3.273 -0

**CALL** ⚠



**838546BK.....37-57**

Intake - Exhaust manifold bolt kit 3.273 -0

**\$5.00 SET** ⚠



**838546U.....37-57**

Intake - Exhaust manifold clamps (spreaders). used 3.273 -0

**\$35.00 SET** ⚠

## Manifold Sleeves-(Metal)



**837273.....34-53**

Intake to head 216ci. Exc 50-53 235ci (3 piece set) 3.281 -0.15

**\$7.50 SET** ⚠



**3835506.....50-62**

Intake to head 235ci, 261ci (3 piece set)

3.281 -0.15

**\$7.50 SET** ⚠

## Odds & Ends

Please call for availability on all Odds & Ends parts; once part is sold, it may no longer be in stock.

**593306.....34-58**

Gas Lines NORS 7in. long 8.964 -0.4

**\$15.00 EA** ⚠

**1573094U.....37-55**

Fuel pump glass bowl used 3.903 -0

**\$10.00 EA** ⚠

**05160.....49**

Carburetor, Carter We w/ Auto Choke 3.724 -0.4

**\$300.00 EA** ⚠

**7002890.....50-51**

Carb Float Bowl, 235ci Rochester (NOS) 3.724 -0.4

**\$25.00 EA** ⚠

**05280.....50-53**

Carburetor, Carter Y-F. For 216ci engine 3.725 -0.4

**\$300.00 EA** ⚠

**5592876.....52**

Diaphragm rebuild kit (NORS). Use w/ part #559226 11.000 -0.4

**\$15.00 EA** ⚠

**5592877.....52-55**

Diaphragm rebuild kit (NORS). Use w/ part #5592627 11.000 -0.4

**\$15.00 EA** ⚠

**5592922.....52-55**

Diaphragm rebuild kit (NORS). Use w/ part #5592765 3.725 -0.4

**\$15.00 EA** ⚠

**700408S.....54-57**

Carburetor Kit - 6 Cyl w/ H.T. 3.724 -0.4

**\$15.00 EA** ⚠





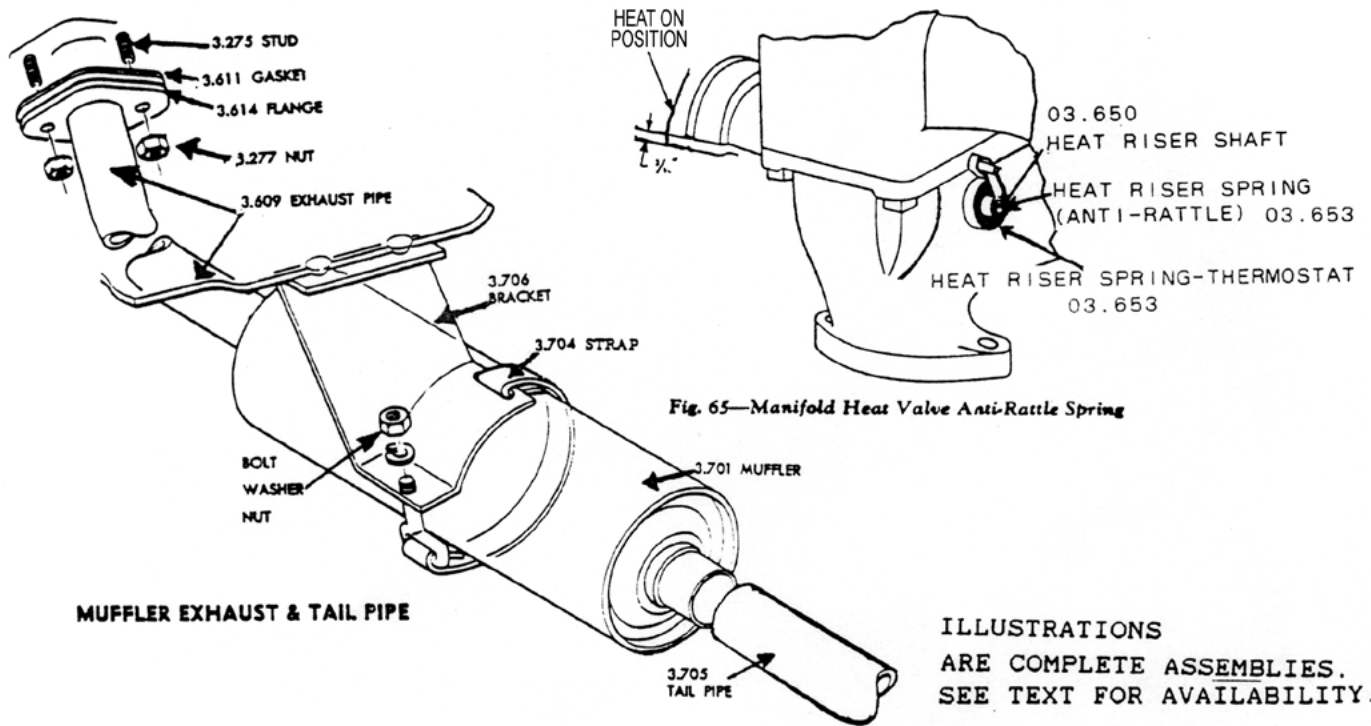

*ILLUSTRATIONS ARE COMPLETE ASSEMBLIES*

*SEE TEXT FOR AVAILABILITY*

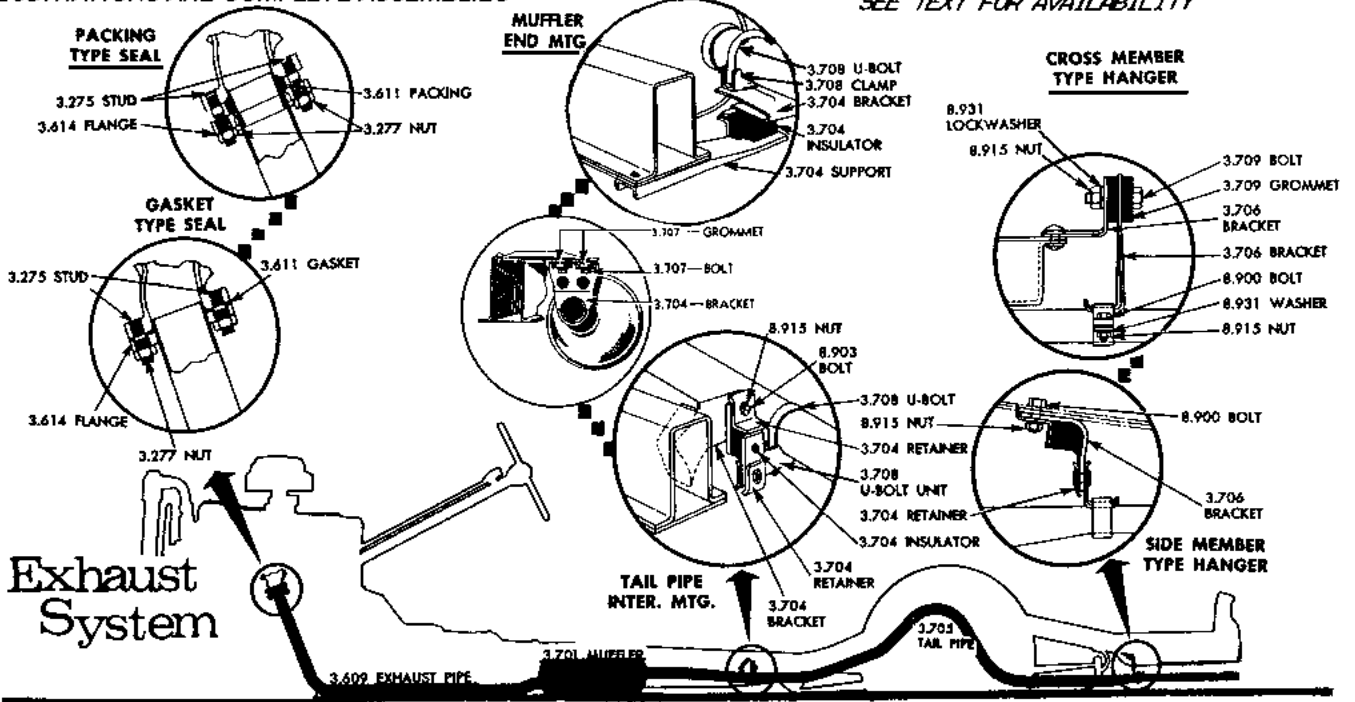

Illustrations are for example and reference only. They do not indicate that we have all the parts shown.



**WARNING:** Cancer and Reproductive Harm — [www.P65Warnings.ca.gov](http://www.P65Warnings.ca.gov)

Chemicals shipped domestic ground only (Lower 48 states only). No international shipping.

Phone: (360) 816-0211 • (800) 999-CHEV (2438) • [www.chevsofthe40s.com](http://www.chevsofthe40s.com)

**SECTION 130T  
STREET ROD PARTS**

**Dual Exhaust System**

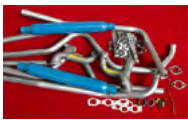

**2031DUAL** .....**47-53**  
Standard Transmission,  
1/2 Ton -0.15  
..... **\$693.50 EA** ⚠

**2032DUAL** .....**54-55**  
First Series (Standard Transmission) 1/2  
Ton -0.15  
..... **\$693.50 EA** ⚠

**Fenton Headers**



**3657963A** .....**37-62**  
Fenton headers. Cast iron, for all 1937-62  
216ci, 235ci & 261ci engines. Comes with  
header flange and gaskets.  
3.609-0.2 ..... **\$199.00 PR** ⚠

**3657963G** .....**37-62**  
Fenton headers. Cast iron, for all GMC  
228ci, 248ci, 270ci & 302ci engines.  
Comes with header flange and gaskets.  
3.609-0 ..... **\$199.00 PR** ⚠

**Fenton Header Parts**



**838574B** .....**37-53**  
Heat kit. Split headers  
to intake. 216ci only.  
3.640-0.2 ..... **\$44.25 EA** ⚠

**3657963S** .....**37-62**  
Bolt set for Fenton headers. 3.609-0  
..... **\$5.50 SET** ⚠



**838573B** .....**50-62**  
Heat kit. Split headers  
to intake. 235ci only.  
3.640-0.2 ..... **\$44.25 EA** ⚠



**3692831** .....**ALL**  
Header pipe to Fenton  
or tube headers  
(requires 2). 3.611-0.15  
..... **\$3.25 EA** ⚠

**Tube Headers**

Tubing is mandrel bent to provide the highest  
flow possible, and fixture welded to ensure  
precise fit. Mounting flanges are O-ringed to  
reduce leakage.



**3657963SS** .....**37-62**  
Polished stainless finish. Includes weld-on  
header pipe flanges. Fits 216ci or 235ci.  
3.609-0.2 ..... **\$175.00 SET** ⚠



**3657963T** .....**37-62**  
Black painted finish. Includes weld-on  
header pipe flanges. Fits 1937-62 216ci,  
235ci & 261ci. 3.609-0.2 ..... **\$125.00 PR**  
⚠

**SECTION 130T  
RESTORATION PARTS**

**Exhaust System**

Note: Complete system includes header pipe  
gasket, studs and nuts, header pipe spring  
(1938-42), header pipe, muffler, muffler  
clamps, muffler hanger, tailpipe and tailpipe  
hanger as needed. Will not fit GMC. All pipes  
are aluminized.

Oversize shipping charges apply to all Exhaust  
Systems. Please call for rate.

**599397B** .....**37-40**  
3/4Ton 3.705-0.15  
..... **\$300.00 EA** ⚠



**599415B** .....**37-40**  
1/2Ton 3.705-0.15 ..... **\$300.00 EA** ⚠

**3656764B** .....**41-46**  
1/2Ton 3.705-0.15 ..... **\$300.00 EA** ⚠

**3656962B** .....**41-48**  
1-1/2 Ton w/ 134-1/2 in. wheelbase.  
3.705-0.15  
..... **\$300.00 EA** ⚠

**3657135B** .....**41-48**  
3/4Ton 3.705-0.15  
..... **\$300.00 EA** ⚠

**Exhaust System, cont.**

**3683656B** .....**47-48**  
1/2Ton 3.705-0.15  
..... **\$300.00 EA** ⚠

**3656962C** .....**49**  
1-1/2Ton w/ 134-1/2 in. wheelbase.  
3.705-0.15  
..... **\$300.00 EA** ⚠

**3657135C** .....**49**  
3/4Ton 3.705-0.15  
..... **\$300.00 EA** ⚠

**3683656C** .....**49**  
1/2Ton 3.705-0.15  
..... **\$300.00 EA** ⚠

**3692828A** .....**50-53**  
1-1/2Ton & 2Ton 216ci. 3.705-0.15  
..... **\$300.00 EA** ⚠

**3696161A** .....**50-53**  
3/4Ton exc. double duty. 3.705-0.15  
..... **\$300.00 EA** ⚠

**3696161C** .....**50-53**  
3/4Ton exc. double duty. 3.705-0.15  
..... **\$300.00 EA** ⚠

**3696806A** .....**50-53**  
1/2Ton 3.705-0.15 ..... **\$300.00 EA** ⚠

**3696806C** .....**50-53**  
1/2Ton w/ 235ci. 3.705-0.15  
..... **\$300.00 EA** ⚠

**3715243A** .....**50-53**  
1Ton 3.705-0.15  
..... **\$300.00 EA** ⚠

**3692828B** .....**50-54**  
1-1/2Ton & 2Ton 235ci. 3.705-0.15  
..... **\$275.00 EA** ⚠

**3696161B** .....**54**  
3/4Ton exc. double duty. 3.705-0.15  
..... **\$300.00 EA** ⚠

**3696806B** .....**54**  
1/2Ton 3.705-0.15 ..... **\$300.00 EA** ⚠

**3715243B** .....**54**  
1Ton 3.705-0.15  
..... **\$300.00 EA** ⚠

**Exhaust Manifold**



**3691971** .....**49-53**  
Exhaust Manifold Fits 49 All (exc D-D,  
COE), 50-53 All 216ci 3.601-0.15  
..... **\$199.00 EA** ⚠



**Manifold Clamps**



**838546B** ..... **37-57**  
Intake - Exhaust manifold clamps (spreaders). Cast reproduction. 3.273-0

**CALL** ⚠



**838546U** ..... **37-57**  
Intake - Exhaust manifold clamps (spreaders). used 3.273-0

**\$35.00 SET** ⚠

**Manifold Gasket**



(3pcs) 3.270-0.15

**602483A** ..... **37-53**  
Intake & exhaust manifold. Fits 216ci

**\$18.50 SET** ⚠



**838290** ..... **37-53**  
Rectangle between manifolds. Fits 216ci 3.272-0.15

**\$6.25 EA** ⚠



**3707045** ..... **50-62**  
Intake & exhaust manifold. Fits 235ci & 261ci (3pcs) 3.270-0.15

**\$17.50 SET** ⚠



**3835572** ..... **50-62**  
Rectangle between manifolds. Fits 235ci & 261ci 3.272-0.15

**\$7.50 EA** ⚠

**Heat Riser Spring**



**602799** ..... **37-54**  
Anti-rattle 3.653-0.4

**\$7.00 EA** ⚠



**838573** ..... **37-54**  
Thermostatic spring. Allows flap to open and close with temperature. 3.653-0.2

**\$17.90 EA** ⚠

**Heat Riser Shaft**



**596264A** ..... **37-54**  
Oversize requires reaming worn manifold holes 3.650-0.15

**CALL** ⚠

**Flange Plate**

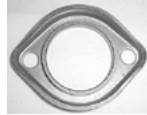

**593607** ..... **37-53**  
Holds header pipe to manifold, 216ci 3.610-0.15

**\$9.50 EA** ⚠

**3696988F** ..... **37-62**  
For Fenton Headers 3.610-0.15

**\$5.50 EA** ⚠



**3696988** ..... **51-57**  
235ci 3.610-0.15

**\$16.00 EA** ⚠

**Gasket**



**593606** ..... **37-49**  
Header pipe to manifold. 3.611-0.15

**\$4.00 EA** ⚠



**3692831** ..... **50-54**  
Header pipe to manifold. 3.611-0.15

**\$3.50 EA** ⚠

**Studs In Manifold**

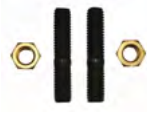

**837552B** ..... **29-54**  
For header pipe, 3/8 in. x 2 in. w/ brass hex nuts 3.275-0

**\$3.25 SET** ⚠

**Spring**



**368244** ..... **32-48**  
Supports rear of header pipe (exc 40-46 1T & 39-46 utility), overall Length 3-1/4". 4.827-0

**\$6.50 EA** ⚠

**Header Pipe**

Oversize shipping charges apply to all Header Pipes. Please call for rate.

**3652725** ..... **37-40**  
All 3.609-0.15

**\$90.00 EA** ⚠



**3684108** ..... **41-48**  
All 3.609-0.15

**\$90.25 EA** ⚠



**3691277** ..... **49**  
All 3.609-0.15

**\$90.00 EA** ⚠

**Header Pipe, cont.**

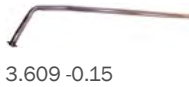

**3693712** ..... **50-53**  
All with 216ci motor. 3.609-0.15

**\$90.25 EA** ⚠



**3693715** ..... **50-54**  
All with 235ci motor. 3.609-0.15

**\$90.00 EA** ⚠

**Muffler**



**Muffler style & sizes vary**

**603746** ..... **35-40**  
3.701-0.15

**\$90.25 EA** ⚠

**3656598** ..... **41-49**  
3.701-0.15

**\$90.25 EA** ⚠

**3693710** ..... **50-54**  
5" dia and 21" long excluding pipes 3.701-0.15

**\$105.00 EA** ⚠

**Muffler Clamp**

**3693811** ..... **37-49**  
Front, 1-7/8in. 3.708-0

**\$2.75 EA** ⚠

**3693812** ..... **37-49**  
Rear, 1-5/8 in. 3.708-0.15

**\$2.50 EA** ⚠



**3693811** ..... **50-54**  
Rear, 1-7/8in. 3.708-0.3

**\$4.25 EA** ⚠

**3694837** ..... **50-54**  
Front, 2 in. 3.708-0.15

**\$2.25 EA** ⚠

**Muffler Hanger**



**3676257**.....**.37-55**  
Includes hardware. 3.704 -0.15 .....  
**\$12.25 EA** ⚠



**3676257A** .....**.47-54**  
Muffler Hanger bracket - Mounts to frame  
and attaches to muffler with strap  
3.704-0.15 ..... **\$17.25 EA** ⚠

**Tailpipe**

Oversize shipping charges apply on all  
tailpipes. Please call for rates.

**599397**.....**.37-40**  
3/4Ton 3.705 -0.15  
..... **\$90.00 EA** ⚠



**599415**.....**.37-40**  
1/2Ton 3.705 -0.15 ... **\$100.00 EA** ⚠



**3656764** .....**.41-46**  
1/2Ton 3.705 -0.15 ..... **\$90.00 EA** ⚠



**3656962** .....**.41-49**  
1-1/2Ton w/ 134-1/2in. wheelbase &  
1Ton. 3.705 -0.15 ..... **\$90.00 EA** ⚠

**Tailpipe, cont.**



**3657135**.....**.41-49**  
3/4Ton 3.705 -0.15 ..... **\$90.00 EA** ⚠

**3683656** .....**.47-49**  
1/2Ton 3.705 -0.15  
..... **\$110.00 EA** ⚠

**3689574**.....**.50-54**  
Panel, Suburban, Canopy Express.  
3.705 -0.15

..... **\$122.50 EA** ⚠



**3692828** .....**.50-54**  
1-1/2Ton & 2Ton, 8-3/8 in. long. 3.705 -0.2  
..... **\$22.25 EA** ⚠



**3696161** .....**.50-54**  
3/4Ton exc Double  
Duty. 3.705 -0.15  
..... **\$90.00 EA** ⚠



**3696806** .....**.50-54**  
1/2Ton 3.705 -0.15 ..... **\$90.00 EA** ⚠

**3715243**.....**.50-59**  
1Ton 3.705 -0.15  
..... **\$90.00 EA** ⚠

**Tailpipe Hanger**



**3656791** .....**.37-54**  
Correct reproduction. 3.706 -0.2  
..... **\$16.50 EA** ⚠

**Tailpipe Hanger, cont.**



**3656791A** .....**.37-54**  
Replacement. 3.706 -0.15 .. **\$5.25 EA**  
⚠

**Tailpipe Clamp**



**594135**.....**.ALL**  
Clamp, original for  
tailpipe extension w/  
nut & bolt. 3.708 -0.15

..... **\$5.75 EA** ⚠

**Tailpipe Heat Shield**

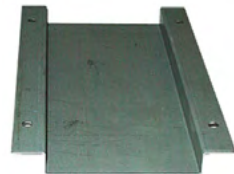

**3689481R** .....**.37-46**  
Under bed. 3.706 -0.15 .. **\$9.75 EA** ⚠

**3689481S** .....**.47-54**  
Under bed. 3.706 -0.15  
..... **\$8.50 EA** ⚠

**3689481SS** .....**.47-54**  
Stainless steel. Under bed. 3.706 -0.15  
..... **\$16.00 EA** ⚠

**Exhaust Extension**



**985707** ..... **41**  
Exhaust Extension  
Whale Tail shaped. Left  
side. Superb stainless  
reproduction of original  
accessory. 3.705 -0.15  
..... **\$346.50 EA** ⚠



**985808**..... **41**  
Exhaust Extension Right  
Side Whale Tail shaped,  
with clamp. Superb  
chrome reproduction of  
original accessory. 3.705 -0.15  
..... **\$347.00 EA** ⚠



**985848** .....**.42-48**  
Bearclaw shape.  
Superb chrome  
reproduction of  
original. 3.705 -0  
..... **\$125.00 EA** ⚠



**Exhaust Extension, cont.**



**51A18529P . . . .ALL**  
Plain, Polished  
Stainless. -0.15  
..... **\$20.00 EA** ⚠



**985992A . . . . .ALL**  
Era accessory  
stainless steel w/  
stamped bowtie.  
3.705 -0.15  
..... **\$18.00 EA** ⚠



**985992C . . . . .ALL**  
CHROME Bowtie  
shaped outlet.  
2-1/4" I.D. (not  
pre-drilled). 3.705 -0.2  
..... **\$32.75 EA** ⚠



**986885S . . . . .ALL**  
STAINLESS STEEL  
Bowtie shape.  
2-1/4" I.D. (not pre-  
drilled). 3.705 -0.15  
..... **\$32.50 EA** ⚠

**Exhaust Paint**



**3657963C . . . . .ALL**  
Exhaust paint  
stainless steel  
pigments. For  
exhaust manifolds &  
pipes. Gives a soft  
grey, metallic finish.  
Pint 3.609 -0  
..... **CALL** ⚠



**3657963D . . . . .ALL**  
Cast blast paint  
high temp 1200  
degree. Grey, fresh  
cast look for exhaust  
manifolds, etc. Rust  
preventative, 11 oz  
spray can. 3.609 -0.15  
..... **\$12.75 EA** ⚠



**3657963E . . . . .ALL**  
Exhaust paint clear,  
high temp (1200  
degree) for exhaust  
etc, 11 oz spray can.  
3.609 -0.15  
..... **\$15.00 EA** ⚠



**3657963FA . . . . .ALL**  
Exhaust paint  
very high temp,  
flat aluminum for  
manifolds & pipes.  
11 oz spray can.  
3.609 -0.15  
..... **\$15.00 EA** ⚠

**Odds & Ends**

Please call for availability on all Odds & Ends parts; once part is sold, it may no longer be in stock.

**3694163 . . . . .50-57**  
Intake manifold. Fits all exc 216ci & DD  
(Used) 3.609 -0.4  
..... **\$65.00 EA** ⚠

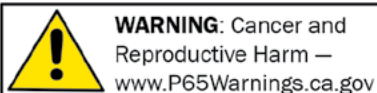

**WARNING:** Cancer and  
Reproductive Harm —  
www.P65Warnings.ca.gov

Chemicals shipped domestic ground only (Lower 48 states only). No international shipping.

**Phone: (360) 816-0211 • (800) 999-CHEV (2438) • www.chevsofthe40s.com**

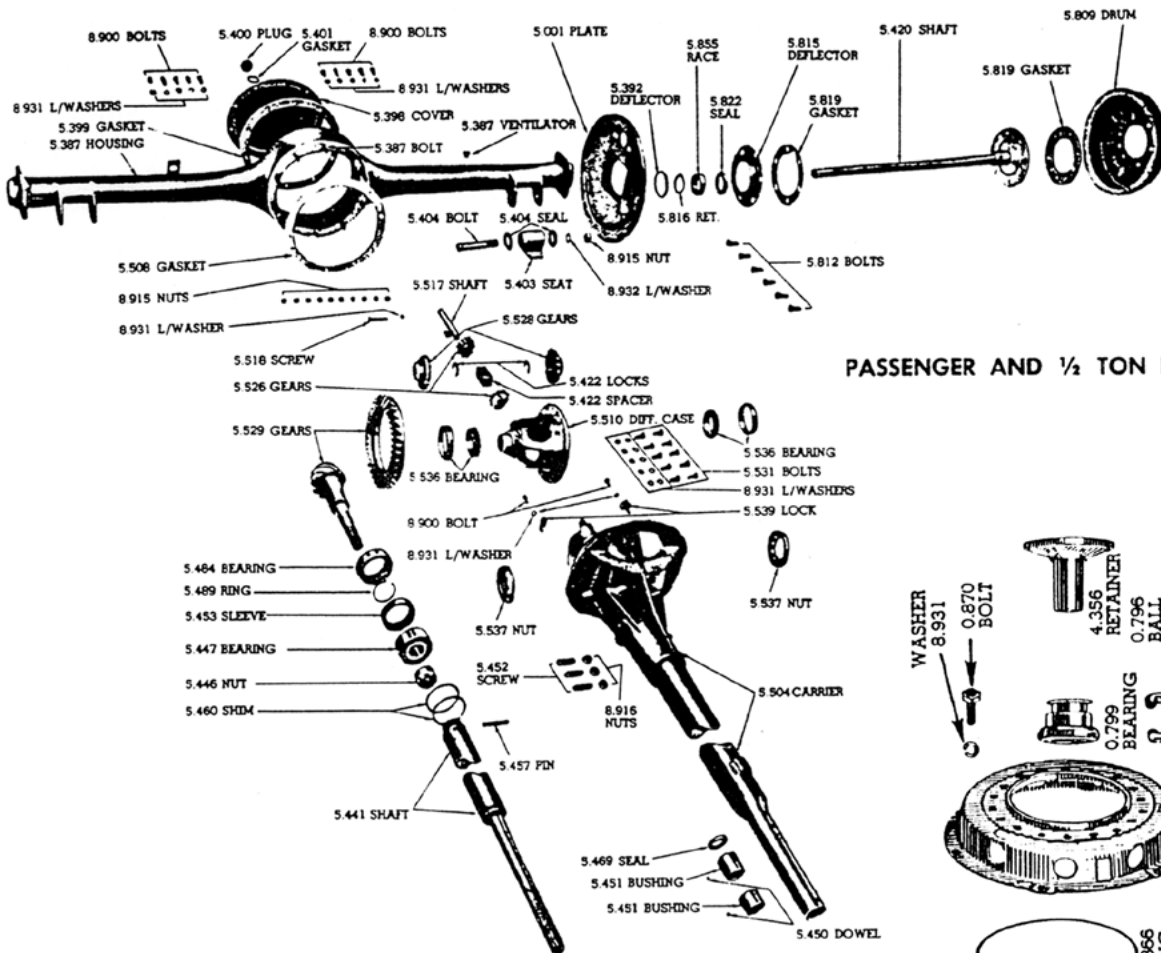

**PASSENGER AND 1/2 TON REAR AXLE**

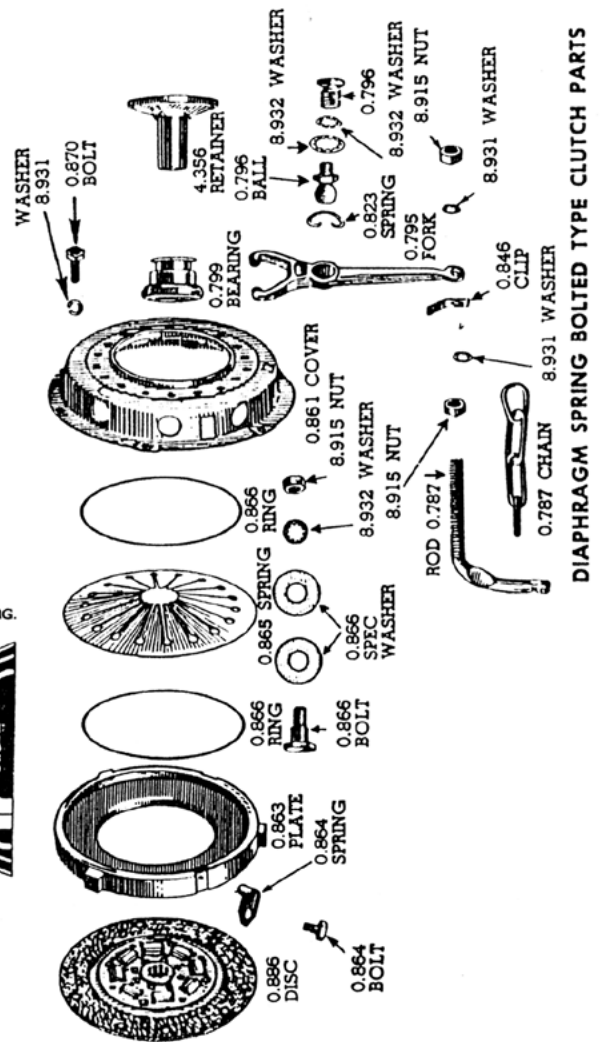

**DIAPHRAGM SPRING BOLTED TYPE CLUTCH PARTS**

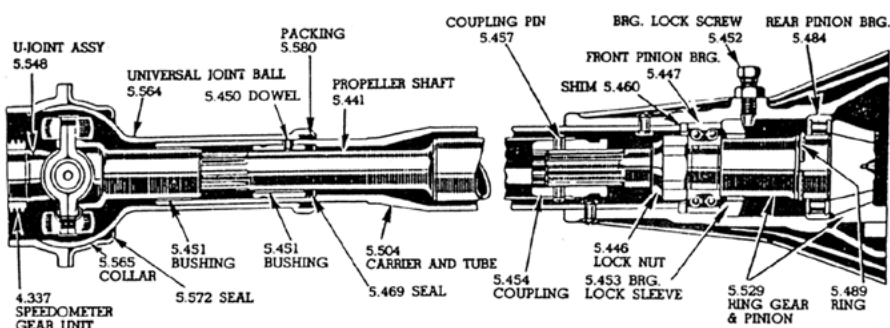

**PROPELLER SHAFT AND HOUSING—PASSENGER CAR**

**WARNING:** Cancer and Reproductive Harm — www.P65Warnings.ca.gov

**SECTION 140T  
RESTORATION PARTS**

**Flywheel Ring Gear**

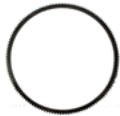

**838177 .....37-54**  
139 teeth (exc  
powerglide). 0.667 -0.2

..... **\$65.00 EA** ⚠

**Complete Clutch Kit**



**838956B .....38-53**  
Replacement 9in. clutch and pressure  
plate kit. Includes pilot bushing, throwout  
bearing, alignment tool and lube. 0.863 -0  
..... **CALL** ⚠

**Pressure Plate**



**838949 .....38-53**  
Rebuilt Heavy duty,  
10-3/4in. (\$150 core).  
0.863 -0.15  
..... **\$179.00 EA** ⚠



**838956 .....38-53**  
Rebuilt 9in. (\$50 core).  
0.863 -0.15  
..... **\$127.00 EA** ⚠



**3836715 .....54-57**  
Rebuilt Use w/ 9in. &  
10in. disc (\$50 core).  
0.863 -0.15  
..... **\$133.25 EA** ⚠

**Clutch Disc**



**3835483 .....38-53**  
Rebuilt 10-3/4in. o.d.  
(\$100 core). 0.886 -0.15  
..... **\$141.00 EA** ⚠



**3835483N .....38-53**  
New 10-1/2" No Core  
0.886 -0  
..... **\$107.25 EA** ⚠



**3847450 .....38-54**  
Rebuilt 9in. o.d. (\$40  
core). 0.886 -0.15  
..... **\$98.00 EA** ⚠



**3836119 .....54-57**  
Rebuilt 10in. (\$40  
core). 0.886 -0.15  
..... **\$107.75 EA** ⚠

**3836119N .....54-57**  
10in. (\$40 core). 0.886 -0  
..... **\$115.00 EA** ⚠

**Tool**



**838956A .....ALL**  
Tool to align clutch disc.  
0.866 -0.3  
..... **\$7.00 EA** ⚠

**Pressure Plate Spring**



**838646 .....38-53**  
Clutch Pressure Plate  
Spring 0.863 -0.3  
..... **\$6.25 EA** ⚠

**Pressure Plate Bolts**



**838653 .....38-57**  
Pressure plate bolts.  
Shouldered 3/8-16,  
1" length, grade 8.  
Includes lock washers.

Set of 6. Restoration only for Chevy I-6cyl.  
0.863 -0.15

..... **\$20.25 SET** ⚠



**839756 .....38-57**  
Mounts flywheel to  
crank. 7/16-20,  
31/32", grade 8.  
Includes lock washers.

Set of 6. Restoration only for Chevy I-6cyl.  
0.669 -0.15

..... **\$20.25 SET** ⚠

**Throwout Bearing**



**909422 .....38-54**  
This is the throw out  
bearing that resides  
in the bellhousing  
for engaging or  
disengaging the clutch. 0.799 -0.2

..... **\$34.25 EA** ⚠

**Pilot Bearing**



**907109 .....31-39**  
This roller style  
pilot bearing fits  
into the end of the  
engine crankshaft

and supports the input shaft of the  
transmission. 0.649 -0.15

..... **\$18.50 EA** ⚠

**Pilot Bushing**



**412562 .....39-66**  
This bushing style  
pilot bearing fits  
into the end of the  
engine crankshaft

and supports the input shaft of the  
transmission.

0.649 -0.2

..... **\$8.00 EA** ⚠

**Throwout Arm Ball**



**2054961C .....32-37**  
2 pieces w/o clips or  
lockwasher. 0.796 -0

..... **CALL** ⚠



**2054961 .....38-54**  
Stud, 1-1/2in. long.  
0.796 -0.4

..... **\$6.00 EA** ⚠

**Clip**



**838987 .....31-54**  
Throwout arm to ball  
stud. 0.823 -0.15

..... **\$6.00 EA** ⚠

**Throwout Arm Spring**



**3664881 .....41-46**  
7-5/16in. 0.844 -0.15

..... **\$10.00 EA** ⚠



**3653114 .....47-54**  
17.5" 0.844 -0.15  
..... **\$10.00 EA** ⚠

**Clutch Pedal Return Spring**



**368244 .....32-46**  
Clutch Pedal Return  
Spring. Overall Length

3-1/4". 4.827 -0.3

..... **\$6.50 EA** ⚠



**3698665 .....47-57**  
Overall length 5-3/4in.

4.827 -0.3

..... **\$10.00 EA** ⚠

**Clutch Linkage Rod**



**3676398 .....47-59**  
Offset rod (L shape)  
2-1/4in. 0.787 -0.15

..... **\$20.50 EA** ⚠



**3676454 .....47-59**  
Rod 7-1/16in. (1 hook

& 1 eye). 0.787 -0.15

..... **\$10.50 EA** ⚠

**Odds & Ends**

Please call for availability on all Odds & Ends  
parts; once part is sold, it may no longer be in  
stock.

**473503 .....33-36**  
2nd & 3rd spd clutch-commercial  
4.380 -0.4

..... **\$35.00 EA** ⚠



**WARNING: Cancer and  
Reproductive Harm —  
www.P65Warnings.ca.gov**

Chemicals shipped domestic ground only (Lower 48 states only). No international shipping.

**Phone: (360) 816-0211 • (800) 999-CHEV (2438) • www.chevsofthe40s.com**

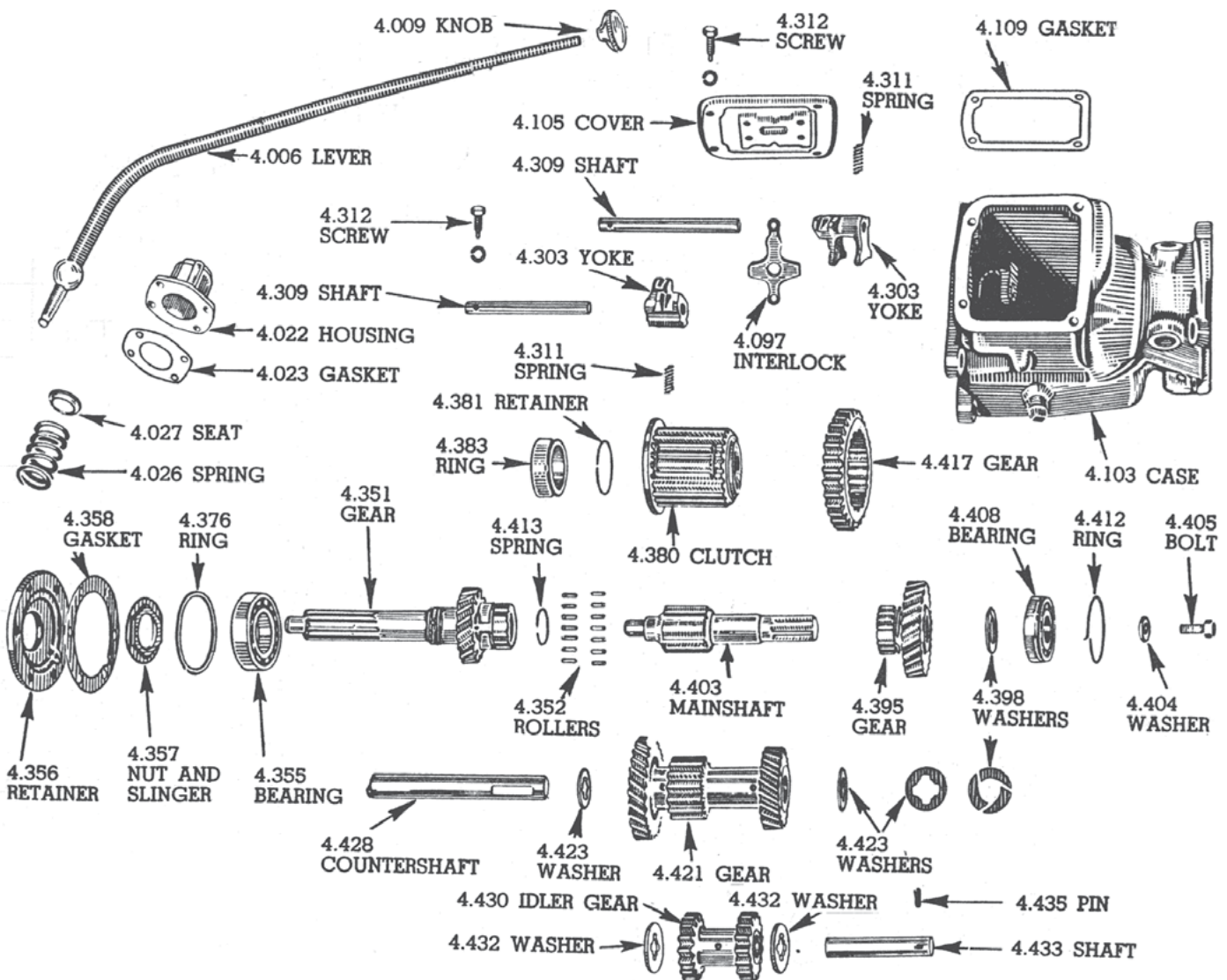

**1937-47 SYNCHRO-MESH TRANSMISSION (CENTER GEARSHIFT)**

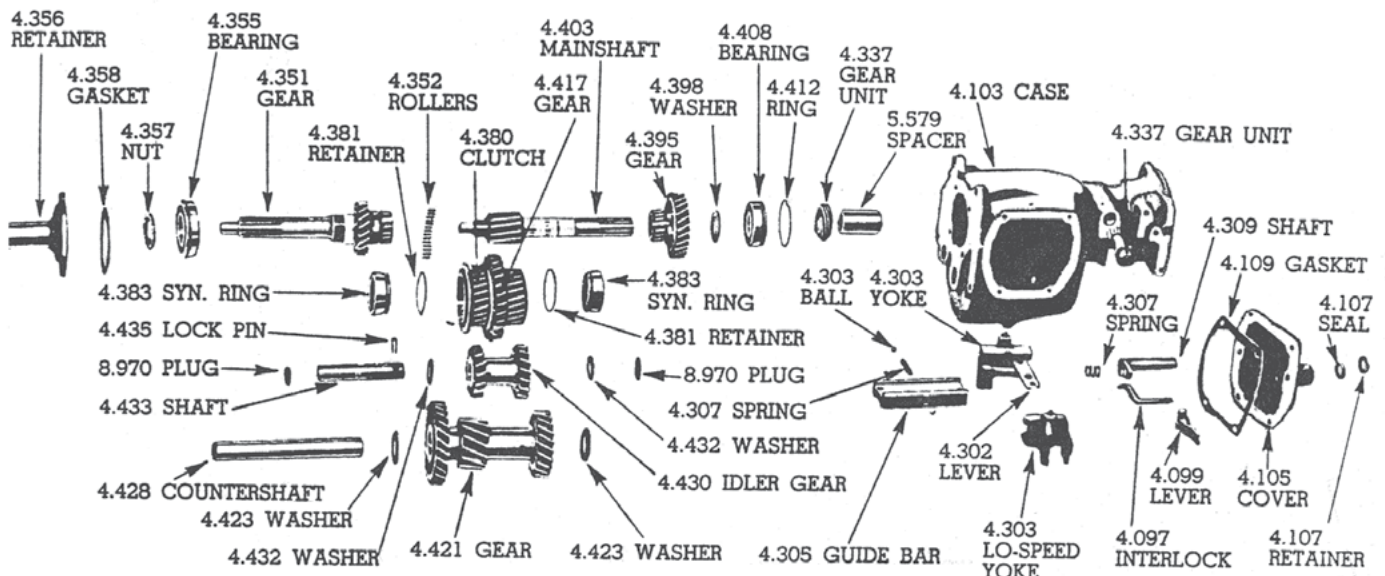

**1939-48 PASS. SYNCHRO-MESH TRANSMISSION (STEERING COLUMN GEARSHIFT)**

Returns require a return authorization number—call first. • Product pricing & availability subject to change.



**WARNING:** Cancer and Reproductive Harm — www.P65Warnings.ca.gov



**SECTION 150T  
STREET ROD PARTS**

**Line Clamp Stainless**



**13275** ..... **ALL**  
3/16" x 3/8" double combination (6  
clamps). 8.950 -0.15 ... **\$18.00 SET** ⚠

**13276** ..... **ALL**  
3/16" x 3/16" double (6 clamps).  
8.950 -0.15  
..... **\$18.00 SET** ⚠

**13284** ..... **ALL**  
5/16" x 3/8" double combination (6  
clamps). 8.950 -0.15  
..... **\$18.00 SET** ⚠

**Crossmember**



**3711049** ..... **42-57**  
Truck Universal transmission mounting  
bracket for engine swap. 4.081 -0.15  
..... **\$62.75 EA** ⚠

**Transmission Mount**

**3711049B** ..... **42-57**  
Rubber, for turbo 350,  
2-hole mount only.  
4.081 -0.15  
..... **\$11.75 EA** ⚠

**3711049C** ..... **42-57**  
Rubber, for turbo 350,  
turbo 400, & 400R,  
1-hole mount. 4.081 -0.2  
..... **\$25.00 EA** ⚠

**SECTION 150T  
RESTORATION PARTS**

Note: Die cut pad & gaskets for floor insert  
over transmission see Section 320T.

**Shift Indicator Dial**



**3705999R** ..... **54-57**  
Shifter Indicator Dial fits 54-57 Hydramatic  
4.038 -0 ..... **\$54.00 EA** ⚠

**Synchro Ring**



**605020A** ..... **40-54**  
Press in, brass 4.380 -0.15 .. **\$25.00 EA** ⚠

**Speedometer Cable**



**1567793** ..... **37-57**  
W/ original housing assembly exc 1939-  
54. 4.342 -0 ..... **\$56.00 EA** ⚠

**1588291A** ..... **37-57**  
Cable without housing. 85" length (0.130  
dia.). 4.342 -0.15  
..... **\$5.75 EA** ⚠

**158829** ..... **39-54**  
W/ original metal housing assembly. 70"  
length. 4.342 -0  
..... **\$18.00 EA** ⚠



**158829P** ..... **39-54**  
W/ plastic housing assembly. 69" length  
4.342 -0 ..... **\$20.50 EA** ⚠

**Tip**



**1565706** ..... **37-57**  
Tip, steel (speedometer  
end of, speedo cable).

4.342 -0.3

..... **\$4.75 EA** ⚠

**Shift Knob**



**374993** ..... **29-47**  
3-speed floor shift push-  
on. Black. 4.009 -0.15

..... **\$8.50 EA** ⚠



**374993B** ..... **29-54**  
4-speed screw-on.  
Black. Chevy & GMC  
4.009 -0.15

..... **\$11.25 EA** ⚠



**985099** ..... **37**  
Brown, accessory.

4.009 -0.15

..... **\$35.00 EA** ⚠



**3686898** ..... **47-53**  
Maroon. Chevy & GMC  
4.009 -0.15

..... **\$13.00 EA** ⚠



**3698233** ..... **54-59**  
Black Chevy & GMC  
4.009 -0.15

..... **\$8.00 EA** ⚠

**Floorshift Seal**



**3653420** ..... **37-47**  
Floor to transmission  
3-speed.

Top: 2-3/4 in. O.D.

Bottom: 2 in. O.D.

Inside Diameter: 1-1/4 in. 4.015 -0.15

..... **\$49.25 EA** ⚠



**3687200** ..... **37-54**  
Floor to transmission  
4-speed. 4.015 -0.15

..... **\$5.50 EA** ⚠

**Floor Shift Boot**



**3651348A** ..... **ALL**  
Replacement-3 speed  
(uses #3654365T trim  
ring). 4.015 -0.3

..... **\$9.50 EA** ⚠

**Trim Ring**



**3654365T** ..... **ALL**  
Stainless retains boot  
#3651348A. 4.044 -0.15

..... **\$13.25 EA** ⚠

**Bushing**



**3710401.....39-57**  
Grommet with metal lining. Shift arm to steering column.  
4.040 -0.15

**\$4.75 EA** ⚠



**365244.....48-53**  
Rubber bushing shift rod ends (4 pcs).  
4.016 -0.15

**\$7.50 SET** ⚠



**365244.....54**  
Rubber bushing shift rod ends (6 pcs).  
4.016 -0.15

**\$11.00 SET** ⚠

**Shift Tube Support Bracket**



**3698234.....48-54**  
Supports top of shift tube under steering wheel. 4.018 -0.15

**\$19.75 EA** ⚠

**Spring & Pivot Pins**



**3654731.....40-57**  
Column shift handle (fits 40-54 car & 48-57 truck). 4.025 -0.15

**\$22.50 SET** ⚠

**Pivot Pins**



**3653719.....40-57**  
Column shift handle (2 pcs). 4.025 -0.15

**\$2.00 PR** ⚠

**Metal Plug**



**142024.....48-54**  
In shift box (also 49-54 car). 9.008 -0.3

**\$1.00 EA** ⚠

**Rubber Bellows**



**3686796.....48-59**  
On shift box, base of steering column.  
4.015 -0.15

**\$3.50 EA** ⚠

**Cluster Gear Bushing**



**591210.....37-53**  
Fits bushing-styled cluster (2 pcs). 4.422 -0.2

**\$15.00 SET** ⚠

**Bearing Transmission**



**954168.....37-54**  
Rear of trans case (tail shaft). Fits 3spd  
4.408 -0.2

**\$45.25 EA** ⚠



**435844.....37-57**  
Front bearing on main drive gear. (3spd)  
4.355 -0.2

**\$45.25 EA** ⚠

**Tailshaft Bushing**



**3717682.....48-54**  
Rear of tailshaft, 1/2T, 4-speed. 4.445 -0

**CALL** ⚠

**Shift Fork**



4.107 -0.15

**591660.....48-55**  
Seal for inside cover, 3-speed (2 pcs).

**\$13.75 SET** ⚠



**3845048.....49-55**  
2nd & 3rd gear (\$20 core). 4.303 -0.15

**\$35.00 EA** ⚠

**Transmission Gasket Set**



**606664.....31-47**  
4-speed. 4.005 -0.15

**\$32.25 SET** ⚠



**3764394.....37-54**  
Transmission gasket set 3-speed (Except Powerglide). Includes torque tube ball seal kit 37234890 4.005 -0.15

**\$21.50 SET** ⚠



**3689458.....48-63**  
Muncie 4-speed. 4.005 -0.15

**\$17.25 SET** ⚠

**Reverse Idler Gear**



**591264.....41-47**  
4 speed. 4.430 -0

**\$30.00 EA** ⚠

**Cluster Shaft**



**591213.....40-57**  
3 speed roller bearing type. Fits bushing w/ modifications. 4.428 -0

**CALL** ⚠

**Soft Plug**



**103892.....39-48**  
End of cluster shaft & reverse idler shaft.  
8.970 -0.4

**\$2.00 EA** ⚠

## Small Parts Kit



**609926**.....**37-54**  
Thrust washers, needle bearings  
(3-speed). 4.004-0.15 .. **\$45.00 KIT**  
⚠

## Transmission Mount



**594117**.....**37-39**  
Transmission Mount.  
4.081-0  
..... **CALL** ⚠



**3652730A**.....**37-54**  
Rebuild kit: Pad & bolts. 4.081-0.15  
**\$10.75 SET** ⚠



**3688234**.....**48-53**  
Steel 4.081-0.15  
..... **\$64.75 EA** ⚠

## Odds & Ends

Please call for availability on all Odds & Ends parts; once part is sold, it may no longer be in stock.

**590481**.....**31-37**  
Front Main Bearing Retainer 12.000-0.4  
..... **\$25.00 EA** ⚠

**609951**.....**34-37**  
Fork Unit Clutch Release COMM & Utility  
12000.000-0.4  
..... **\$20.00 EA** ⚠

**590853**.....**37-39**  
Shift Yoke Shaft 1st & Reverse All 3  
speed 12000.000-0.4  
..... **\$35.00 EA** ⚠

**590925**.....**37-39**  
Reverse idler gear for 3 Speed (NOS)  
12.000-0.4  
..... **\$30.00 EA** ⚠

**590927**.....**37-39**  
3-speed 4.421-0.3  
..... **\$160.00 EA** ⚠

**954451**.....**37-39**  
Bearing diff. side 37-39 all util. 5.536-0.4  
..... **\$40.00 EA** ⚠

## Odds & Ends, cont.

**591119**.....**40**  
Retainer trans rear bearing (All 4 speed)  
4.317-0.4  
..... **\$45.00 EA** ⚠

**905207**.....**41-47**  
Bearing Propeller Shaft 5.436-0.4  
..... **\$30.00 EA** ⚠

**3682372**.....**46-47**  
Propeller shaft bearing retainer (NOS)  
5.439-0.4  
..... **\$20.00 EA** ⚠

**954394**.....**46-50**  
Front pinion bearing. All 1/2T (NOS)  
4.355-0.4  
..... **\$50.00 EA** ⚠

**591667**.....**48-50**  
Counter Gear, 1st Speed all w/ 4 speed  
12000.000-0.4  
..... **\$75.00 EA** ⚠

**3686836**.....**48-54**  
Gearshift Operating Lever & Clamp  
12.000-0.4  
..... **\$12.00 EA** ⚠

**3687429**.....**48-54**  
Clamp, Gearshift Selector housing  
12000.000-0.4  
..... **\$10.00 EA** ⚠

**591501**.....**48-54**  
Input shaft COMM & Utility w/ 4 speed  
4351.000-0.4  
..... **\$25.00 EA** ⚠

**3686812**.....**48-55**  
Lever, Gearshift Selector, 2nd & 3rd (4-  
1/4in) fits 48-52 COMM, 53-55 COMM  
1st series exc DD, 55 COMM 3sp 6 cyl  
2nd series 4.016-0.4  
..... **\$15.00 EA** ⚠

**3692608**.....**48-57**  
Trans Main Shaft 4 speed (All)  
12000.000-0.4  
..... **\$65.00 EA** ⚠

**591603**.....**48-57**  
Clutch Gear Synchronizing Cone 4 Speed  
4.384-0.4  
..... **\$35.00 EA** ⚠

**591906**.....**48-57**  
Yoke, 1st & 2nd Speed All (4sp)  
12000.000-0.4  
..... **\$30.00 EA** ⚠

**954358**.....**48-57**  
Bearing Front On Main Drive Gear  
4.355-0.4  
..... **\$24.75 EA** ⚠

**954864**.....**48-57**  
Bearing Main Shaft Rear (4 speed)  
4.408-0.4  
..... **\$30.00 EA** ⚠

## Odds & Ends, cont.

**954869**.....**48-57**  
Main shaft gear 4.112-0.4  
..... **\$40.00 EA** ⚠

**591780**.....**49-54**  
2 & 3rd Shifter Shaft W Plate 12.000-0.4  
..... **\$12.00 EA** ⚠

**3688159**.....**49-55**  
Lever, Gearshift Selector, 2nd & 3rd (5-  
1/4in overall length), fits 49-54 pass 3sp,  
53-55 DD 3sp 1st series, 4.016-0.4  
..... **\$15.00 EA** ⚠

**3691568N**.....**50-52**  
Ring-washer torque conv retain NOS  
13000.000-0.4  
..... **\$6.00 PR** ⚠

**3692835**.....**50-54**  
Collar, U-joint Ball 50-54 Pass Powerglide  
13.000-0.4  
..... **\$25.00 EA** ⚠

**3694491**.....**51-54**  
Reverse Band Brake Strut, P/g (NOS)  
12.000-0.4  
..... **\$70.00 EA** ⚠

**904913**.....**54-55**  
Bearing 3 Speed, rear trans (COMM)  
4.405-0.4  
..... **\$30.00 EA** ⚠

**1307238**.....**54-61**  
Transmission Oil Plug w/ Seal (NOS)  
12.000-0.4  
..... **\$6.00 EA** ⚠

**5668232**.....**55-56**  
Mast jacket bearing assembly, fits  
COMM & Utility 6.521-0.4  
..... **\$40.00 EA** ⚠

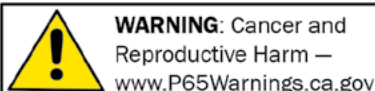

Chemicals shipped domestic ground only (Lower 48 states only). No international shipping.

**Phone: (360) 816-0211 • (800) 999-CHEV (2438) • www.chevsofthe40s.com**

**SECTION 160T  
RESTORATION PARTS**

**U-Joint Rebuild Kit**



**609948.....33-53**  
33-39 4 speed front, rear exc VE, VF; 40 front exc KC, WD; 41-53 front 3/4 exc Double-Duty. 5.548 -0.15 .. **\$35.50 EA** ⚠



**609944.....40-54**  
Fits car & 1/2T.  
Includes lock plates and Bolts 5.548 -0.15  
..... **\$54.50 EA** ⚠

**U-Joint Lock Plates**



**3723489.....40-54**  
2 plates & 4 bolts 5.586 -0.4 .. **\$10.25 SET** ⚠

**U-Joint Assembly**



**602795.....37-39**  
W/ yokes, 3/4T, 3-speed. 5.548 -0.15 ... **\$178.50 EA** ⚠  
**3653380.....40**  
W/ yokes 1-1/2T (exc WD). 5.548 -0 ..... **\$153.00 EA** ⚠  
**604373.....40-47**  
W/ yokes 3/4 & 40 1t 3-speed front. 5.548 -0.2 ..... **\$99.00 EA** ⚠  
**591642.....48-54**  
W/ yokes 1/2T 3-speed. 5.548 -0 ..... **CALL** ⚠

**Torque Tube**



**3723490.....29-54**  
Ball seal kit, for drive shaft 29-40 & 41-54 cars, 1/2T & 3/4T truck w/ manual trans. 5.572 -0.15 ..... **\$20.75 EA** ⚠

**Dowel Pin**



**347813.....29-50**  
5/16 in. , retains drive shaft bushing. 5.450 -0.3 ..... **\$7.50 EA** ⚠

**Coupling Pin**



**3657332.....40-54**  
Drive shaft to pinion. 5.457 -0.3 ..... **\$10.00 EA** ⚠

**Drive Shaft Bushing**



**3694733.....51-54**  
Rear, Car & 1/2T Truck. 5.451 -0 ..... **CALL** ⚠

**Drive Shaft Seal**



**595010.....37-39**  
1/2, 3/4 & 1T. 5.469 -0.3 ... **\$14.00 EA** ⚠  
**3691457.....40-50**  
40 all & 41-50 1/2T. 1" i.d. 5.469 -0.15 ..... **\$14.50 EA** ⚠

**Oakie Bushing & Seal**

Replaces front & rear drive shaft bushing & seal without disassembling rear end and driveline.



**595005B.....37-39**  
Car, 1/2T, 3/4T & 1T 5.451 -0.15 ..... **\$87.75 EA** ⚠



**3652328B.....40-50**  
Car and 1/2 ton truck. 5.451 -0.1 ..... **\$90.25 EA** ⚠



**609930A.....40-50**  
Oakie bushing seal 5.451 -0.15 ..... **\$8.75 EA** ⚠



**3694733B.....51-54**  
Car, 1/2T 5.451 -0.15 ..... **\$88.00 EA** ⚠

**Tool Oakie Bushing Puller**



**595005A.....37-54**  
Drive shaft bushing puller to rent (return in original condition for \$20.00 refund). 5.451 -0.15 ..... **\$75.00 EA** ⚠

**Odds & Ends**

Please call for availability on all Odds & Ends parts; once part is sold, it may no longer be in stock.  
**901105.....33-35**  
Pinion shaft bearing. Rear exc CC 13.000 -0.4 ..... **\$25.00 EA** ⚠  
**370416.....33-39**  
Prop Shaft Bushing, Front (Utility) 13000.000 -0.4 ..... **\$20.00 EA** ⚠  
**3653931.....40**  
Propeller shaft housing bushing front 13000.000 -0.4 ..... **\$25.00 EA** ⚠

**SECTION 170T  
RESTORATION PARTS**

**Rear Axle Cover**



**475308** ..... **37-62**  
 Chrome with chrome filler plug. Chevy  
 1/2Ton & 1937-42 3/4 and 1Ton trucks.  
 Does not include gasket, use 370245  
 37-59. 5.398 -0 ..... **\$60.00 EA** ⚠

**Ring & Pinion Conversion Kit**



**3705439A** ..... **40-54**  
 3.55:1 Chevy and GMC trucks 1/2 ton  
 only! Bolt in for 1940-53 (1937-39  
 requires drive line modifications). 1954  
 1/2 Ton truck needs the correct carrier  
 to install this conversion (spool casting  
 #3652336-40-43, 1/2 Ton trucks).  
 Will not fit Canadian spec trucks.  
 5.529 -0.15 ..... **\$370.00 SET** ⚠

**Ring & Pinion Installation Kit**



**3705430KT** ..... **40-50**  
 Chevy truck gaskets, seals, bearings.  
 5.529 -0.15 ..... **\$499.00 SET** ⚠



**3705439KT** ..... **51-54**  
 Chevy truck. Gaskets, Seals, Bearings.  
 5.529 -0.15 ..... **\$499.00 EA** ⚠

**Ring & Pinion Shim Set**



**SHIMSET01** ..... **37-54**  
 Ring & Pinion Shim  
 Set -0.3  
 ..... **\$21.25 EA** ⚠

**Rear Axle Seal**



**592441** ..... **33-54**  
 1/2T & 37-42 3/4 & 1T.  
 5.822 -0.4  
 ..... **\$32.19 EA** ⚠

**3663166** ..... **41-42**  
 Except 1/2T. 5.469 -0.3  
 ..... **\$17.00 EA** ⚠



**3686563** ..... **46-57**  
 3/4 & 1T. 5.822 -0.15  
 ..... **\$18.75 EA** ⚠

**Rear Axle Bearing & Seal**



**111121B** ..... **37-54**  
 Fits 1937-1954 1/2 ton and 1937-1942  
 3/4 ton and 1 ton truck. Does 1 side.  
 5.855 -0.4 ..... **\$99.38 SET** ⚠

**188930B** ..... **46-57**  
 3/4 & 1T. 5.855 -0  
 ..... **\$81.25 SET** ⚠

**Rear Axle Bearing**



**111121** ..... **37-54**  
 1/2T & 37-42 3/4 & 1T.  
 5.855 -0.4  
 ..... **\$74.75 EA** ⚠



**188930** ..... **46-57**  
 3/4 & 1T. 5.855 -0.15 ..... **\$65.50 EA** ⚠

**Axle Gasket**



**370245** ..... **37-59**  
 Center cover on rear  
 axle, rear gasket, 1/2T  
 & 37-42 3/4 & 1T.  
 5.399 -0.15  
 ..... **\$12.25 EA** ⚠



**370246** ..... **37-59**  
 Differential to axle  
 housing, front gasket,  
 1/2T & 37-42 3/4 & 1T.  
 5.508 -0.3  
 ..... **\$14.50 EA** ⚠

**Differential Fill**



**344829** ..... **29-54**  
 Plug w/ gasket. 5.400 -0  
 ..... **CALL** ⚠

**Carrier Bearing**



**7450385** ..... **46-56**  
 1/2T & 40-42 3/4T & 1T (uses 2).  
 5.536 -0.15 ..... **\$75.75 EA** ⚠

**Pinion Seal**



**3653618** ..... **40-57**  
 40 COE, 41-42 1-1/2T  
 & larger (exc 1/2T  
 & 40-55 2-speed).  
 5.469 -0.4  
 ..... **\$24.00 EA** ⚠

**Pinion Bearing**



**125630** ..... **35-54**  
 Rear. Cars; 35-54 pass  
 & 53-55 Corvette.  
 Trucks; 35-42 COMM,  
 46-54 1/2Ton 5.484 -0.3  
 ..... **\$64.50 EA** ⚠



**954780** ..... **35-54**  
 Front, Passenger &  
 1/2T. 5.447 -0.15  
 ..... **\$53.00 EA** ⚠

**Spring Pivot Seals**



**597267** ..... **38-54**  
 Rear end to spring pivot  
 bolt (4 ea). 5.404 -0.3  
 ..... **\$15.75 SET** ⚠

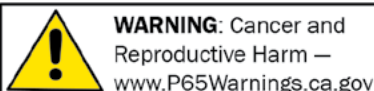

**WARNING:** Cancer and  
 Reproductive Harm —  
[www.P65Warnings.ca.gov](http://www.P65Warnings.ca.gov)

Chemicals shipped domestic ground only (Lower 48 states only). No international shipping.

**Phone: (360) 816-0211 • (800) 999-CHEV (2438) • www.chevsofthe40s.com**

170T

## Bushing Rear Spring Pivot



**3652182A** ..... **.48-54**  
 Bolt w/ nut, rear end to spring pivot,  
 1/2Ton. 5.403-0.15 ..... **\$33.00 PR** ⚠

## Odds & Ends

Please call for availability on all Odds & Ends parts; once part is sold, it may no longer be in stock.

**901305**.....**.33-39**  
 Bearing Pinions Shaft NOS Rear Utility  
 13000.000 -0.4  
 ..... **\$25.00 EA** ⚠

**473636**.....**.36-57**  
 Nut-Rear Wheel Bearing (36-53 Utility)  
 13000.000 -0.4  
 ..... **\$10.00 EA** ⚠

**473636N** .....**.36-57**  
 Nut-Rear Wheel Bearing NOS (36-53  
 Utility) 13000.000 -0.4  
 ..... **\$15.00 EA** ⚠

**595647**.....**.37-39**  
 Shaft Bolt Lock Axle 3-1/8 I.D.  
 13000.000 -0.4  
 ..... **\$15.00 EA** ⚠

**3651377**.....**.39-41**  
 Stud, shaft to hub cap 2 spd axle 1.5 ton  
 13000.000 -0.4  
 ..... **\$6.00 SET** ⚠

**3653928** .....**.40-47**  
 Spacer gasket, metal rear wheel hub w/  
 1/2in. axle bolt holes fits utility 5.811-0.4  
 ..... **\$10.00 EA** ⚠

**7450385N** .....**.46-56**  
 Carrier Bearing- 1/2in. (NOS) w/ race.  
 5.536 -0.4  
 ..... **\$60.00 SET** ⚠

**901604**.....**.48-50**  
 Bearing counter shaft rear (4-speed)  
 4.408 -0.4  
 ..... **\$30.00 EA** ⚠



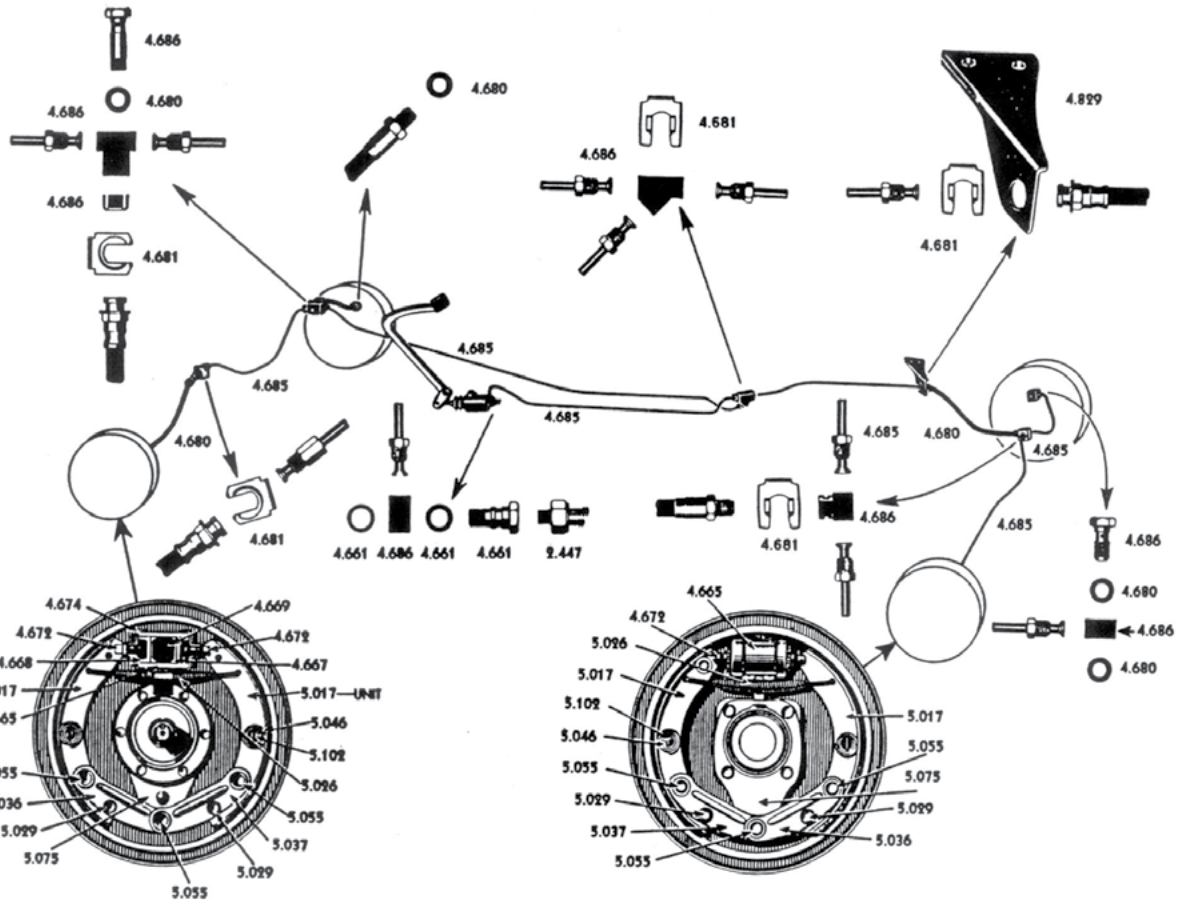

HYDRAULIC BRAKE SYSTEM

ILLUSTRATIONS ARE COMPLETE ASSEMBLIES. SEE TEXT FOR AVAILABILITY.

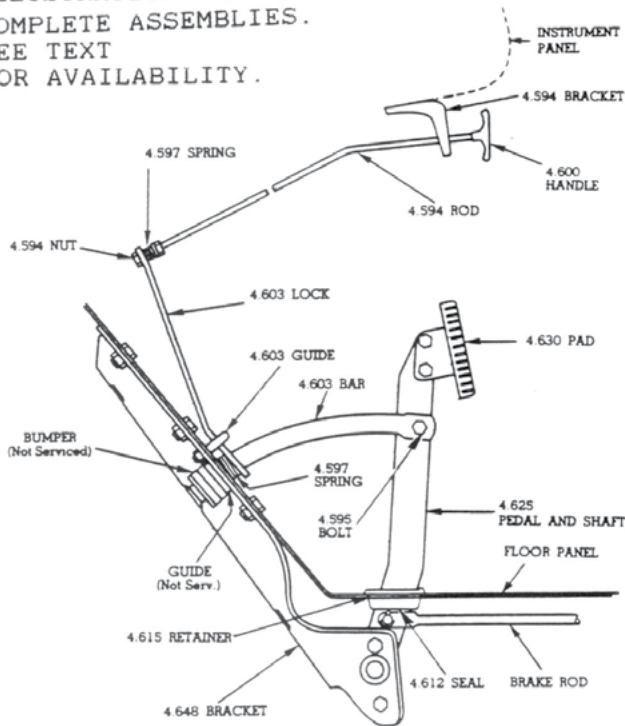

TRUCK PARKING BRAKE CONTROLS (FOOT OPER.)

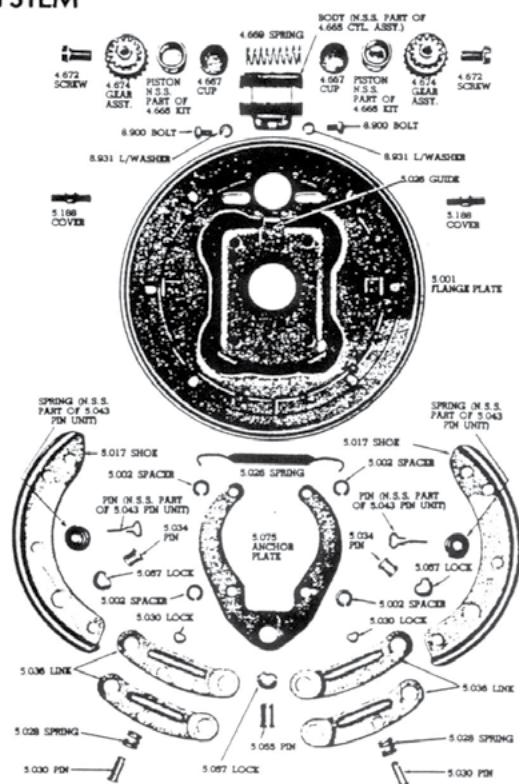

HYDRAULIC BRAKE PARTS—FRONT



**WARNING:** Cancer and Reproductive Harm — [www.P65Warnings.ca.gov](http://www.P65Warnings.ca.gov)

Chemicals shipped domestic ground only (Lower 48 states only). No international shipping.  
**Phone: (360) 816-0211 • (800) 999-CHEV (2438) • [www.chevsofthe40s.com](http://www.chevsofthe40s.com)**

**SECTION 180T  
STREET ROD PARTS**

**Master Cylinder & Brake Booster Assy**



**EC-505** ..... **47-54**  
New 7" booster & master cylinder assembly. Mounts in stock location using original brake pedal. Auto Trans only. 1/2 Ton only. -0.15 ..... **\$459.00 KIT** ⚠

**Master Cylinder Dual Reservoir For Disc Brakes**

For drum/drum use 10lb valve in front line.  
For disc/drum use 2lb valve in front line.  
Large reservoir for front, small reservoir rear.



**EC-445** ..... **ALL**  
67-72 Mustang w/ 1" bore. disc/drum applications -0.15 ..... **\$64.00 KIT** ⚠

**Master Cylinder Adapter Kit**



**EC-420** ..... **47-54**  
Adapts either EC-445 or EC-446 master cylinder to the stock brake pedal in the stock master cylinder location on 47-54 Chevy 1/2 ton trucks. Supplied with pushrod, rod end & hardware. -0

..... **\$96.50 KIT** ⚠

**Disc Brake Conversion Kit**

**EC-6711SCK** ..... **28-40**  
Car & 1/2 ton truck. Complete kit for straight axles. Including rotors, calipers, pads, brackets & fasteners (brake hoses sold separately). 6x5.5" lug. Does not include bearings or seals. Uses original bearings and seals for 29-40. Inner Bearing 909002 26-40, Outer Bearing 909001 29-57, Seal 352488 29-40. -0 ..... **\$527.00 KIT** ⚠

**Disc Brake Conversion Kit, cont.**



**EC-711S** ..... **28-40**  
Car & 1/2 ton truck. Bracket kit only (no rotors, calipers, pads, etc). (exc. 33-36 standard cars and trucks w/ light duty spindle). -0.15 ..... **\$221.75 KIT** ⚠



**EC-711SCK** ..... **28-40**  
Car & 1/2 ton truck. Complete kit for straight axles. Including rotors, calipers, pads, brackets & fasteners (brake hoses sold separately). 5x4-3/4" lug. (exc. 33-36 standard cars and trucks w/ light duty spindle). -0 ..... **\$521.50 KIT** ⚠

**EC-6711CK** ..... **41-54**  
1/2 ton truck. Complete kit for straight axles. Including rotors, calipers, pads, brackets & fasteners (brake hoses sold separately). 6x5.5" lug NO HUB, NO SEALS, NO BEARINGS -0 ..... **\$501.75 KIT** ⚠



**EC-711** ..... **41-54**  
1/2 ton truck, Bracket kit only (no rotors, calipers, pads, etc). 1/2 ton only. -0.15 ..... **\$218.50 KIT** ⚠



**EC-711CK** ..... **41-54**  
For 1/2 Ton Truck. Complete kit including rotors, calipers, pads, brackets & fasteners (brake hoses sold separately). 5 lug standard. -0 ..... **\$521.50 KIT** ⚠

**Disc Brake Conversion Kit, cont.**

**EC-751** ..... **ALL**  
Rubber brake hose kit for ECI conversion kits. Front only. 10mm for '78-81 GM Calipers. -0.15 ..... **\$60.00 PR** ⚠

**Line Clamp Stainless**



**13274** ..... **ALL**  
3/16" single (12 clamps). 8.950 -0.15 ..... **\$18.25 SET** ⚠

**13275** ..... **ALL**  
3/16" x 3/8" double combination (6 clamps). 8.950 -0.15 ..... **\$18.00 SET** ⚠

**13276** ..... **ALL**  
3/16" x 3/16" double (6 clamps). 8.950 -0.15 ..... **\$18.00 SET** ⚠

**13277** ..... **ALL**  
1/4" single (12 clamps). 8.950 -0.15 ..... **\$18.00 SET** ⚠

**13278** ..... **ALL**  
5/16" single (12 clamps). 8.950 -0.15 ..... **\$18.00 SET** ⚠

**13279** ..... **ALL**  
3/8" single (12 clamps). 8.950 -0.15 ..... **\$18.00 SET** ⚠

**13280** ..... **ALL**  
1/2" single (12 clamps). 8.950 -0.15 ..... **\$18.00 SET** ⚠

**13281** ..... **ALL**  
5/8" single (8 clamps). 8.950 -0.15 ..... **\$18.00 SET** ⚠

**13282** ..... **ALL**  
3/4" single (8 clamps). 8.950 -0.15 ..... **\$18.00 SET** ⚠

**13283** ..... **ALL**  
7/8" single (8 clamps). 8.950 -0.15 ..... **\$18.00 SET** ⚠

**13284** ..... **ALL**  
5/16" x 3/8" double combination (6 clamps). 8.950 -0.15 ..... **\$18.00 SET** ⚠



# Section 180T: Brake Parts

## Line Clamp Stainless, cont.



**13285**.....ALL  
1/4" x 1/4" double (6 clamps). 8.950 -0.15  
..... **\$18.00 SET** ⚠

**13286**.....ALL  
5/16" x 5/16" double (6 clamps).  
8.950 -0.15  
..... **\$18.00 SET** ⚠

**13287**.....ALL  
3/8" x 3/8" double (6 clamps). 8.950 -0.15  
..... **\$18.00 SET** ⚠

**13288**.....ALL  
1/2" x 1/2" double (6 clamps). 8.950 -0.15  
..... **\$18.00 SET** ⚠

**13289**.....ALL  
5/8" x 5/8" double (4 clamps). 8.950 -0.15  
..... **\$18.00 SET** ⚠

**13290**.....ALL  
3/4" x 3/4" double (4 clamps). 8.950 -0.15  
..... **\$18.00 SET** ⚠

**13291**.....ALL  
7/8" x 7/8" double (4 clamps). 8.950 -0.15  
..... **\$18.00 SET** ⚠

## Clamp



**120521**.....ALL  
1/4 in. bolt-on strap.  
For wire or tube (4 pcs).  
8.950 -0.4  
..... **\$2.59 SET** ⚠



**120521A**.....ALL  
5/16 in, insulated bolt-on  
strap. For wire or  
tube (4 pcs). 8.950 -0.4  
..... **\$3.29 SET** ⚠



**120521B**.....ALL  
3/8 in. bolt-on strap.  
For wire or tube (4 pcs).  
8.950 -0.4  
..... **\$3.25 SET** ⚠

## Brake Cleaner



**6129423**.....ALL  
Superior cleaner.  
Many uses (spray  
can). APPLICATIONS:  
ABS, disc, drum,  
brake cylinders,  
brake drums, brake  
linings, brake shoes,  
calipers, clutch  
discs, disc brake

pads, discs. Safe for use on all brake  
systems including: Springs & Wedge  
brakes.

4.683 -0.2

..... **\$4.00 EA** ⚠

## SECTION 180T RESTORATION PARTS

### Brake Overhaul Kit



**BRKHAUL**.....36-50

Brake Overhaul Kit.

Kit includes:

Shoes & Linings for 4 wheels  
4 Wheel Cylinder Kits (rubber cups only)  
1 Master Cylinder Kit  
4 Wheel Hold Down Kits

3 Brake Hoses  
Brake Return Springs  
4 Adjusting Hole Covers  
Fits cars and 1/2 ton trucks. 5.017 -0.15

..... **\$199.00 KIT** ⚠

**BRKHAUL**.....51-52

Brake Overhaul Kit.

Kit includes:

Shoes & Linings for 4 wheels  
4 Wheel Cylinder Kit (rubber cups only)  
1 Master Cylinder Kit  
4 Wheel Hold Down Kits

3 Brake Hoses  
Brake Return Springs  
4 Adjusting Hole Covers  
Fits cars and 1/2 ton trucks. 5.017 -0.15

..... **\$165.25 KIT** ⚠

## Brake Overhaul Kit, cont.

**BRKHAUL**.....53-54

Brake Overhaul Kit.

Kit includes:

Shoes & Linings for 4 wheels  
4 Wheel Cylinder Kit (rubber cups only)  
1 Master Cylinder Kit  
4 Wheel Hold Down Kits  
3 Brake Hoses  
Brake Return Springs  
4 Adjusting Hole Covers

Fits cars and 1/2 ton trucks. 5.017 -0.15

..... **\$250.00 KIT** ⚠

## Master Cylinder Adapter Kit

**PGCONV1**.....50-54

Use this kit to convert a standard master  
cylinder to work in your powerglide car or  
keep your standard master cylinder when  
converting to automatic.. Use with  
5453737 40-52 or 5454126 53-54 -0.15

..... **\$55.00 EA** ⚠

## Emergency Brake Release



**3690404**.....48-51

Handle (chrome). 4.592 -0.15

..... **\$10.00 EA** ⚠



**3687252**.....48-55

U-bolt for foot brake  
release lock guide.  
4.603 -0.15

..... **\$22.75 EA** ⚠



**1990717**.....52-53

Knob chrome w/  
maroon center. Original  
color and quality.  
4.600 -0

..... **CALL** ⚠



**1990717A**.....54

Knob (black), original  
color and quality.  
4.600 -0.15

..... **\$10.00 EA** ⚠



**WARNING:** Cancer and  
Reproductive Harm —  
www.P65Warnings.ca.gov

Chemicals shipped domestic ground only (Lower 48 states only). No international shipping.

Phone: (360) 816-0211 • (800) 999-CHEV (2438) • www.chevsofthe40s.com

**Emergency Brake Bracket**



**3687303 . . . . .48-55**

For foot operated pedal. 4.648 -0.15

..... **\$49.50 EA** ⚠

**Emergency Brake Cable**



**597327 . . . . .37-46**

1/2 ton (takes 2). Does not include clevis. 55" length. 4.826 -0.15

**\$55.25 EA** ⚠

**3694170 . . . . .47-54**

1/2 ton (takes 2) (1947-50 use your end). 4.826 -0.15

..... **\$39.00 EA** ⚠

**Gasket Emergency Cable**



**476136 . . . . .36-54**

Emergency cable to backing plate.

4.834 -0.2 ..... **\$5.00 PR** ⚠

**Boot**



**3691420 . . . . .37-54**

Emergency cable to cable housing.

4.834 -0.15 ..... **\$6.00 SET** ⚠

**Clevis End Pin**



**3682642 . . . . .37-53**

Emergency brake.

4.833 -0.3

..... **\$6.00 PR** ⚠



**3687752 . . . . .47-54**

Emergency brake cable

4.826 -0.15

..... **\$8.00 EA** ⚠

**Control Rod Assembly**



**3689297 . . . . .48-54**

Emergency brake (goes back to cables).

Fits 1/2T. 4.826 -0.15 **\$120.00 SET** ⚠

**Grommet**



**3696521 . . . . .51-54**

Emergency brake

release 9.775 -0.15

..... **\$5.50 EA** ⚠

**Anti Rattle Rubber Spacer**



**369387 . . . . .37-54**

Hand brake handle

release rod. 4.605 -0.4

..... **\$7.00 EA** ⚠

**Spring**



**373980 . . . . .32-57**

Emergency hand brake

release lever. 4.597 -0.15

..... **\$5.00 EA** ⚠



**3695565 . . . . .48-55**

Parking brake release

spring 4.597 -0.15

..... **\$6.00 EA** ⚠

**Brake Pedal Return Spring**



**368244 . . . . .36-46**

Brake Pedal Return Spring. Overall Length

3-1/4". 4.827 -0 ..... **\$6.50 EA** ⚠



**3698665 . . . . .47-57**

Overall length 5-3/4in. 4.827 -0.3

..... **\$10.00 EA** ⚠

**Bushings**



**3682074 . . . . .37-46**

Clutch & brake pedal

shaft (13/16 in. O.D. x

3/4 in. I.D. x 1-25/64

in. long) 4.626 -0.15

..... **\$27.00 PR** ⚠

**Bushings, cont.**



**3683016 . . . . .47-54**

Clutch & Brake Pedal

Shaft (1-1/16 in. O.D.

X 1 in. I.D. X 1-1/4 in.

Long) 0.831 -0.15

..... **\$20.00 PR** ⚠

**Tinnerman Nuts**



**365897 . . . . .ALL**

Retains rear brake

drum (6 pcs). 5.810 -0.2

..... **\$7.50 SET** ⚠

**Brake Drum Gasket**

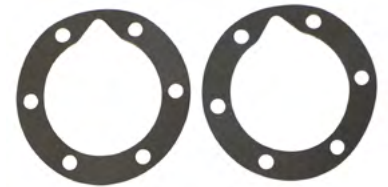

**365673 . . . . .29-57**

Brake drum (6 lug) front or rear. 5.819 -0.15

..... **\$3.75 PR** ⚠

**Brake Drum**



**601985 . . . . .36-50**

Rear 1/2Ton & 37-42 3/4Ton (6 lug). 6 on

5-1/2 in. bolt pattern. 5.809 -0.15

..... **\$89.50 EA** ⚠



**602432A . . . . .36-50**

Front, straight axle. 1/2Ton & commercial

(6 lug). 6 on 5-1/2 in. bolt pattern. 5.809 -0

..... **\$125.00 EA** ⚠



**3696266 . . . . .51-56**

Front or rear 1/2Ton. 6 on 5-1/2 in. bolt

pattern 5.809 -0.15 ..... **\$59.00 EA** ⚠



**Brake Shoes**



- 3681129** ..... **36-52**  
36-50 1/2Ton front & rear, 37-42 3/4Ton rear w/ 11 in. brakes, 37-52 3/4Ton front, 37-42 1Ton front (does 2 wheels) 5.017 -0.2 ..... **\$40.00 SET** ⚠
- 3695709**..... **51-56**  
Rear 2 wheels (\$15 core) w55b. 5.017 -0.15 ..... **\$40.00 SET** ⚠
- 3696177**..... **51-56**  
Front 2 wheels (\$15 core). 5.017 -0.15 ..... **\$35.00 SET** ⚠
- 3703512** ..... **53-59**  
3/4Ton & 1Ton front, 3/4Ton rear (exc. 14 in. brakes, duals & 7.50 in. x 17 in. tire). 5.017 -0.15 ..... **\$52.00 PR** ⚠

**Brake Shoe Hold Down Kit**



- 3696704** ..... **51-57**  
2 wheels (8 pcs). 5.043 -0.15 ..... **\$8.00 SET** ⚠

**Brake Shoe Hold Down**



- 475506**..... **36-50**  
J-hook (2 pcs). 1 set does 1 wheel 5.102 -0.3



- 475509**..... **36-50**  
Spring (2 pcs). 1 set does 1 wheel 5.046 -0.4

**Brake Shoe Return Springs**



- 475511**..... **37-50**  
For 2 wheels (2 pcs) 36-42 all, 46-50 1/2Ton, 3/4Ton front only. 5.026 -0.3 ..... **\$7.00 SET** ⚠

**Brake Shoe Return Springs, cont.**



- 3680890** ..... **46-52**  
3/4Ton rear and 1Ton front. 5.026 -0.15 ..... **\$14.00 EA** ⚠

**Brake Shoe Springs**



- 3694822** ..... **51-54**  
Return & adjusting, Passenger & 1/2Ton (does 2 wheels) (6 pcs). 5.026 -0.15 ..... **\$9.00 SET** ⚠

**Pin Lock**



- 358829**..... **30-52**  
Shoe anchor 29/32in. o.d. (1/2T& most 3/4T) (3 Pieces - 1 Set Per Wheel) 5.057 -0 ..... **\$6.00 SET** ⚠



- 358829E**..... **30-52**  
Replacement (e-clip) brake shoe, 29/32in. o.d. (2 pcs). 5.057 -0 ..... **\$1.75 SET** ⚠



- 359380**..... **30-57**  
Shoe anchor 1-3/16 in. O.D. some 3/4Ton & most 1Ton (2 pcs). 5.057 -0.3 ..... **\$8.75 PR** ⚠

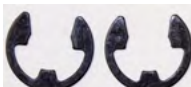

- 359380E**..... **30-57**  
E-clip for brake shoe, 1-3/16 in. O.D. some 3/4Ton & most 1Ton (2 pcs). 5.057 -0.4 ..... **\$2.75 SET** ⚠



- 475508**..... **36-52**  
Brake shoe 9/16 in. O.D. (exc. 51-52 1/2Ton) (2 pcs) 1 set does 1 wheel 5.030 -0.25 ..... **\$3.00 SET** ⚠



- 475508E**..... **36-52**  
E-clip. Replaces original on brake shoe. 9/16 in. O.D. (exc 51-52 1/2Ton) (2 pcs). 1 set does 1 wheel 5.030 -0 ..... **\$1.75 SET** ⚠

**Adjuster Assembly**



- 496351B** ..... **51-57**  
Brake shoe w/ star wheel, fits Passenger & 1/2T. 5.110 -0.15 ..... **\$11.50 EA** ⚠

**Brake Adjust Hole Plugs**



- 475516**..... **36-54**  
Plugs (original metal) (8 pcs). 5.188 -0.3 ..... **\$8.50 SET** ⚠



- 475516B**..... **36-54**  
Plugs (rubber) (8 pcs). 5.188 -0.4 ..... **\$6.75 SET** ⚠

**Brake Hose**



- 476719**..... **36-54**  
36-50 all, 51-54 3/4Ton only, takes 3. 4.680 -0.2 ..... **\$17.99 EA** ⚠
- 3696551** ..... **51-57**  
Takes 3. (Except 3/4 ton) 4.680 -0.15 ..... **\$14.50 EA** ⚠

**U-clip**



- 334961**..... **36-57**  
For brake hose to frame (uses 3) (3 piece set). 4.681 -0.4 ..... **\$3.00 SET** ⚠

**Copper Washer**



- 231343**..... **36-57**  
For brake hose (3 pcs). 4.671 -0.4 ..... **\$3.50 SET** ⚠



Chemicals shipped domestic ground only (Lower 48 states only). No international shipping.

Phone: (360) 816-0211 • (800) 999-CHEV (2438) • www.chevsofthe40s.com

# Section 180T: Brake Parts

## Brake Line Sets

Oversize shipping charges apply to all Brake Line Sets. Please call for rate.



Brake lines shown may vary from your specific model

- 3696844** ..... **.37-52**  
Pre bent Steel 3/4Ton (specify year when ordering). 4.865 -0 .....starting at **\$145.00 SET** ⚠
- 369684S** ..... **.37-52**  
Pre bent Stainless 3/4Ton (specify year when ordering). 4.865 -0 .....starting at **\$155.00 SET** ⚠
- 3696833** ..... **.37-54**  
Steel 1/2Ton (specify year when ordering). 4.865 -0 .....starting at **\$145.00 SET** ⚠
- 369683S** ..... **.37-54**  
Stainless 1/2Ton (specify year when ordering). 4.865 -0 .....starting at **\$170.00 SET** ⚠

## Gasket Master Cylinder Cap



- 080445** ..... **.37-57**  
Master cylinder cap. 4.651 -0.15 ..... **\$1.50 EA** ⚠

## Master Cylinder



- 5450257** ..... **.36-37**  
1/2Ton (\$100 core). 4.650 -0.15 ..... **\$175.00 EA** ⚠



- 5454381** ..... **.38-46**  
Except 1/2Ton 4.650 -0.15 ..... **\$125.00 EA** ⚠

## Master Cylinder, cont.



- 5454576** ..... **.38-46**  
Rebuilt 1/2Ton (\$125 core). 4.650 -0 ..... **\$250.00 EA** ⚠

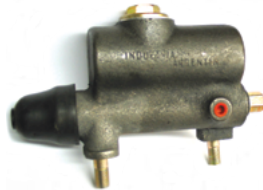

- 5454576E** ..... **.38-46**  
New for 1/2Ton. Includes push rod. 4.650 -0.15 ..... **\$156.00 EA** ⚠



- 5454575** ..... **.47-50**  
1/2Ton (\$35 core). Chevy & GMC 4.650 -0.15 ..... **\$94.00 EA** ⚠



- 5454382** ..... **.47-51**  
Except 1/2Ton . Chevy & GMC 4.650 -0.15 ..... **\$119.00 EA** ⚠



- 5454384** ..... **.51**  
1/2Ton (\$35 core). Chevy & GMC 4.650 -0 ..... **\$125.00 EA** ⚠

## Master Cylinder, cont.



- 5454382** ..... **.52-54**  
1-1/2Ton, 2Ton & 52 Double Duty. 4.650 -0.15 ..... **\$107.50 EA** ⚠



- 5454459** ..... **.52-54**  
1/2Ton & 53-54 3/4Ton & 1Ton (exc. Hydramatic & Double Duty) Chevy & GMC New 4.650 -0.15 ..... **\$98.00 EA** ⚠

- 5454459R** ..... **.52-54**  
1/2Ton & 53-54 3/4Ton & 1Ton (exc. Hydramatic & Double Duty) (\$35 core). Chevy & GMC Rebuilt 4.650 -0 ..... **\$250.00 EA** ⚠



- 5454384** ..... **.53-54**  
Double Duty & Hydramatic (\$35 core). 4.659 -0.15 ..... **\$125.00 EA** ⚠

## Master Cylinder Rebuild Kit



- 5453950** ..... **.36-50**  
1/2Ton (1 in. bore). 4.650 -0.15 ..... **\$20.00 EA** ⚠



- 5454428** ..... **.36-59**  
1937-1952 3/4-ton, 1938-1952 1-ton, 1936-1959 1 1/2-ton, and 1947-1959 2-ton trucks. (1 1/4-inch bore) (1-1/4 in. bore). 4.649 -0.15 ..... **\$29.25 EA** ⚠

Returns require a return authorization number—call first. • Product pricing & availability subject to change.



**WARNING:** Cancer and Reproductive Harm — www.P65Warnings.ca.gov

**Master Cylinder Rebuild Kit, cont.**



**5450962** ..... **51-54**  
1/2Ton & 53-54 3/4Ton, 1Ton (1-1/8 in. bore). 4.649-0.15 ..... **\$32.75 EA** ⚠

**Floor Plug Master Cylinder**



**592865** ..... **36-54**  
Master cylinder inspection (in floor). 3-3/8 in. diameter for 3 in. hole. 12.541-0.15 ..... **\$8.00 EA** ⚠

**Rubber Boot Master Cylinder**



**5450551** ..... **36-57**  
On master cylinder. 4.659-0.15 ..... **\$5.75 EA** ⚠

**Front Wheel Cylinder**



**5300869** ..... **36-52**  
36-50 1/2Ton, 3/4Ton, 1Ton, 1-1/2Ton, 2Ton & 51-52 3/4Ton (exc. 50 Double Duty). 4.665-0.15 ..... **\$39.50 EA** ⚠

**5453780** ..... **51-52**  
1-1/2Ton & 2Ton. 1-3/8" bore 4.665-0.15 ..... **\$117.50 EA** ⚠

**5455478R** ..... **51-59**  
Right 1/2Ton. 4.665-0.15 ..... **\$28.00 EA** ⚠

**5455479L** ..... **51-59**  
Left 1/2Ton. 4.665-0.15 ..... **\$28.00 EA** ⚠

**Front Wheel Cylinder, cont.**

**5453819** ..... **53-54**  
1-1/2Ton & 2Ton (1 in. piston). 4.665-0 ..... **\$45.00 EA** ⚠

**Rear Wheel Cylinder**



**5300866** ..... **36-50**  
1/2Ton, 37-42 3/4Ton w/ 11 in. drum. 4.665-0.2 ..... **\$40.00 EA** ⚠

**5300885** ..... **36-50**  
1-1/2Ton. 4.665-0.15 ..... **\$69.75 EA** ⚠

**5450071** ..... **37-52**  
1Ton & 3/4Ton w/ 14 in. drum. 4.665-0.15 ..... **\$62.50 EA** ⚠

**5453865** ..... **51-53**  
Rear on rear axle (1-1/2Ton, 2Ton). 4.665-0.15 ..... **\$124.00 EA** ⚠

**5453866** ..... **51-53**  
Front on rear axle (1-1/2Ton, 2Ton). 4.665-0.15 ..... **\$124.00 EA** ⚠

**5453819** ..... **51-54**  
Rear. Also fits 53-55 Corvette. 4.665-0.15 ..... **\$28.00 EA** ⚠

**5455480L** ..... **53-57**  
Left, 1Ton. 4.665-0.15 ..... **\$22.00 EA** ⚠

**5455480R** ..... **53-57**  
Right, 1Ton. 4.665-0.2 ..... **\$22.00 EA** ⚠

**5454313** ..... **53-59**  
Front on rear axle (1-1/2Ton, 2Ton). 4.665-0.15 ..... **\$77.75 EA** ⚠

**5454314** ..... **53-59**  
Rear on rear axle (1-1/2Ton, 2Ton). 4.665-0.15 ..... **\$73.25 EA** ⚠

**Front Wheel Cylinder Rebuild Kit**



**5450431** ..... **36-52**  
36-50 1/2Ton, 3/4Ton, 1Ton, 1-1/2Ton, 2Ton & 51-52 3/4Ton (exc 50 Double Duty) (1-1/4 in. bore). 4.665-0 ..... **\$18.50 EA** ⚠



**5455661** ..... **51-59**  
1/2Ton & 53-57 3/4Ton & 1Ton. 4.665-0.15 ..... **\$7.00 EA** ⚠



**5455660** ..... **53**  
1-1/2Ton & 2Ton. 4.665-0.3 ..... **\$11.50 EA** ⚠



**5454399** ..... **54-59**  
1-1/2T & 2T. 4.665-0.2 ..... **\$9.00 EA** ⚠

**Rear Wheel Cylinder Rebuild Kit**



**5450429** ..... **36-50**  
1/2Ton & 37-42 3/4Ton with 11 in. drum (1-3/16 in. bore). 4.665-0.15 ..... **\$23.50 EA** ⚠

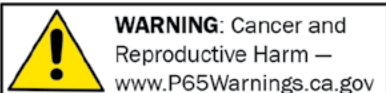

**WARNING:** Cancer and Reproductive Harm — [www.P65Warnings.ca.gov](http://www.P65Warnings.ca.gov)

Chemicals shipped domestic ground only (Lower 48 states only). No international shipping.

**Phone: (360) 816-0211 • (800) 999-CHEV (2438) • [www.chevsofthe40s.com](http://www.chevsofthe40s.com)**

# Section 180T: Brake Parts

## Rear Wheel Cylinder Rebuild Kit, cont.

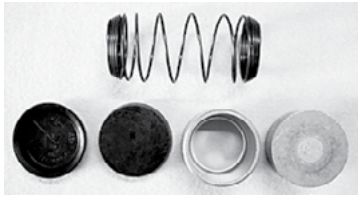

**5450435** ..... **36-50**  
W/ pistons 1-1/2Ton & 2Ton (1-1/2 in. bore). 4.665 -0.2 ..... **\$45.00 EA** ⚠



**5450434** ..... **36-52**  
W/ pistons 3/4Ton with 14 in. drum 40-52 1Ton (exc. Double Duty) (1-3/8 in. bore). 4.665 -0.15 ..... **\$29.00 EA** ⚠



**5454488** ..... **51-57**  
1-1/2Ton & 2Ton. 4.665 -0.15 ..... **\$24.50 EA** ⚠



**5455661** ..... **51-57**  
3/4Ton (exc 56 Double Duty). 4.665 -0 ..... **\$7.00 EA** ⚠



**5455660** ..... **51-59**  
1/2Ton 4.665 -0.3 ..... **\$11.50 EA** ⚠



**5454252** ..... **53-59**  
1Ton 4.665 -0.15 ..... **\$14.75 EA** ⚠

## Wheel Cylinder Rod



**509233** ..... **51-57**  
Rod connecting wheel cylinder to brake shoes 4.675 -0.3 ..... **\$4.00 EA** ⚠

## Bleeder Valve



**5300926** ..... **36-57**  
Wheel cylinder. 4.666 -0.2 ..... **\$1.50 EA** ⚠

## Brake Line Junction Bolt



**476099** ..... **36-50**  
Brake line junction block bolt. Fits 36-50 all (inc. GMC) 4.686 -0.15 ..... **\$6.00 EA** ⚠

## Brake Line Junction Block



**476100** ..... **36-50**  
Block for rear line to wheel cylinder. Fits 1936-50 ALL, 51-57 3/4Ton, 1Ton & Utility. 4.686 -0.15 ..... **\$21.00 EA** ⚠



**497756** ..... **36-57**  
Block for rear brake hose at rear axle housing. Fits 1936-50 All, 1951-57 3/4Ton, 1Ton & Utility. 4.686 -0.15 ..... **\$21.50 EA** ⚠



**3692044** ..... **47-57**  
Block. Front brake line at master cylinder. Fits 49-54 Convertible & 47-53 Chevy trucks. Includes nut. 4.686 -0.15 ..... **\$28.00 EA** ⚠



**3696540** ..... **51-54**  
Block, left front brake line at master cylinder. Fits 1951-54 PASS (EXC. CONV) & 52-54 1/2Ton. 4.686 -0 ..... **CALL** ⚠

**3696553** ..... **51-55**  
Block for rear line to wheel cylinder. Fits 51-54 Pass, 51-55 1st Ser 1/2ton, 53-55 Corvette -0 ..... **\$19.00 EA** ⚠

## Brake Line Junction Block, cont.



**3696552** ..... **51-57**  
Block for rear brake hose at rear axle housing. Fits 1951-57 Pass. & 1/2Ton. 4.686 -0.15 ..... **\$23.00 EA** ⚠

## Clip



**148129A** ..... **ALL**  
Double ended, holds 1/4in. brake & 5/16 in. gas line to frame (snaps into hole). 8.950 -0.4 ..... **\$5.00 EA** ⚠



**3735074C** ..... **ALL**  
3/8 in. slot, gas, brake line, wire harness (4 pcs). 8.950 -0.15 ..... **\$6.50 SET** ⚠

## Brake Light Switch



**1997725** ..... **36-42**  
Hydraulic (41-42 COE only). Screw on terminal 2.447 -0.15 ..... **\$13.50 EA** ⚠



**403936** ..... **41**  
Hydraulic. Exc. COE. Press on terminal 2.447 -0.2 ..... **\$10.75 EA** ⚠



**1997901** ..... **42-54**  
Mechanical (exc 42 COE). 2.447 -0 ..... **\$13.50 EA** ⚠

## Brake Light Switch T Fitting



**652B** ..... **ALL**  
Add a hydraulic brake light switch to your 3/16" brake line. -0.4 ..... **\$9.75 EA** ⚠

**652C** ..... **ALL**  
Add a hydraulic brake light switch to your 1/4" brake line. -0 ..... **CALL** ⚠

Returns require a return authorization number—call first. • Product pricing & availability subject to change.

**124 Phone: (360) 816-0211 • (800) 999-CHEV (2438) • www.chevsofthe40s.com**



**WARNING:** Cancer and Reproductive Harm — [www.P65Warnings.ca.gov](http://www.P65Warnings.ca.gov)

**Brake Fluid**



**5450285B . . . . .ALL**  
Master "Fade Free"  
DOT 4 (12 oz).  
4.683 -0.15  
..... **\$7.00 EA** ⚠



**603486B . . . . .ALL**  
Mac's, DOT 5,  
silicone. Less  
corrosion. 12 ounce  
bottle. 4.683 -0.15  
..... **\$10.25 EA** ⚠

**Odds & Ends**

Please call for availability on all Odds & Ends parts; once part is sold, it may no longer be in stock.

- 1409123 . . . . . 36**  
Wheel brake cylinder cup rear 1-1/16in.  
4.665 -0.15  
..... **\$2.00 EA** ⚠
- 144526 . . . . . 36-40**  
Inner Race & Roller outer axle bearing  
13000.000 -0.4  
..... **\$25.00 EA** ⚠
- 5450431N . . . . . 36-48**  
Wheel brake cylinder spring & cups. Front  
for 1-1/4 in. bore, Delco NOS. 4.665 -0.4  
..... **\$15.00 SET** ⚠
- 5300890 . . . . . 36-50**  
Wheel brake cylinder cup 1-1/2in. rear  
4.665 -0.15  
..... **\$2.00 EA** ⚠
- 592420U . . . . . 36-50**  
Pin for brake link used 5.036 -0  
..... **\$15.00 EA** ⚠
- 596565 . . . . . 37-50**  
Bolt, flange plate spacer fits 1937-52  
Utility Exc COE, HD or 1946-50 1-1/2T  
except school bus chassis 5.002 -0.4  
..... **\$15.00 PR** ⚠
- 597235 . . . . . 39**  
Front anchor plate & links. 5.075 -0.4  
..... **\$40.00 EA** ⚠
- 3650735 . . . . . 39-48**  
Seal - wheel bearing front fits 39 COE,  
40-48 2 Ton & 46-48 school bus chassis  
6.326 -0.4  
..... **\$10.00 EA** ⚠

**Odds & Ends, cont.**

- 5451615-1 . . . . . 46-48**  
Wheel brake cylinder rear 4.665 -0.4  
..... **\$19.00 EA** ⚠
- 5450073 . . . . . 46-50**  
Wheel brake cylinder cups front 1-3/8in.  
4.665 -0.15  
..... **\$2.00 EA** ⚠
- 7450131 . . . . . 49-53**  
Front inner bearing, 49-50 2 ton  
13000.000 -0.3  
..... **\$45.00 EA** ⚠
- 3693451 . . . . . 51-55**  
Backing Plate, Rear Left fits 51-54  
Passenger, 53-55 Corvette, 51-55 1/2Ton  
(1st series) 5.001 -0.4  
..... **\$35.00 EA** ⚠
- 3693452 . . . . . 51-55**  
Brake backing plate right side 5.001 -0.4  
..... **\$34.00 EA** ⚠
- 3695834 . . . . . 51-57**  
Propeller shaft dual shoe brake link outer  
connecting angle on one end fits 51-55 1  
ton utility first series except COE, 55-57  
2nd series all 5.610 -0.4  
..... **\$15.00 EA** ⚠
- 5450031 . . . . . 51-59**  
Wheel brake cylinder cups. Fits 51-52  
and 53-59 CBL 4.665 -0.15  
..... **\$2.00 EA** ⚠
- 3687294 . . . . . 52-55**  
Foot brake pedal latch bar, COMM NOS  
14000.000 -0.4  
..... **\$17.50 EA** ⚠
- 5455484N . . . . . 53-57**  
Wheel cylinder rear 1 ton DD  
14000.000 -0.4  
..... **\$55.00 EA** ⚠
- 5300866U . . . . . 54-60**  
Wheel cylinder NOS shelf worn 4.665 -0.4  
..... **\$50.00 EA** ⚠
- 5300800 . . . . . ALL**  
Wheel cylinder cup 1-3/16 in 4.667 -0.15  
..... **\$2.00 EA** ⚠

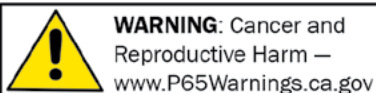

Chemicals shipped domestic ground only (Lower 48 states only). No international shipping.

**Phone: (360) 816-0211 • (800) 999-CHEV (2438) • www.chevsofthe40s.com**

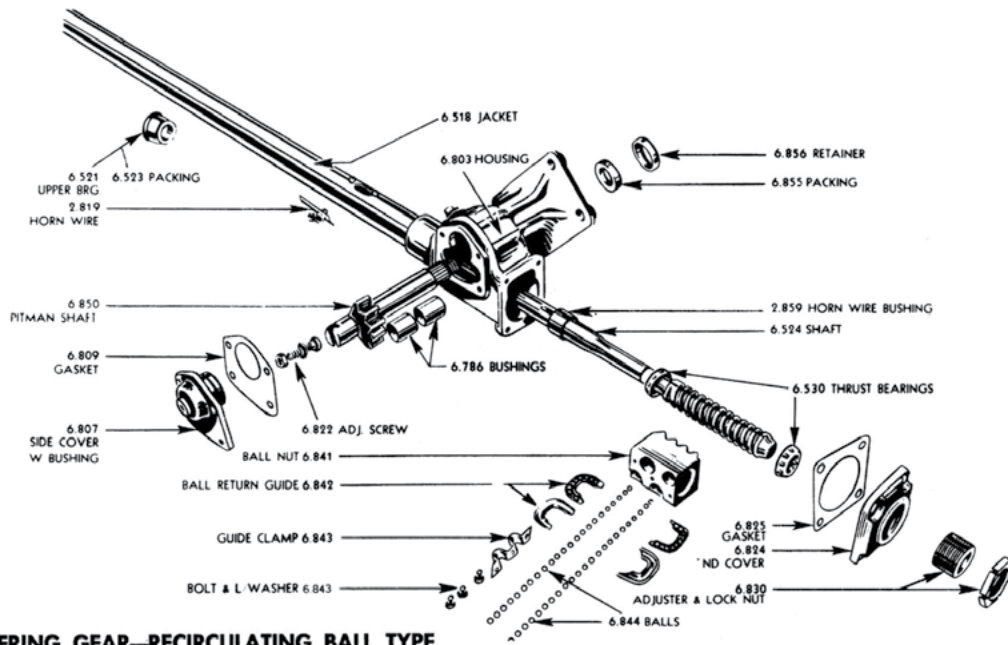

**1941-46 STEERING GEAR—RECIRCULATING BALL TYPE**

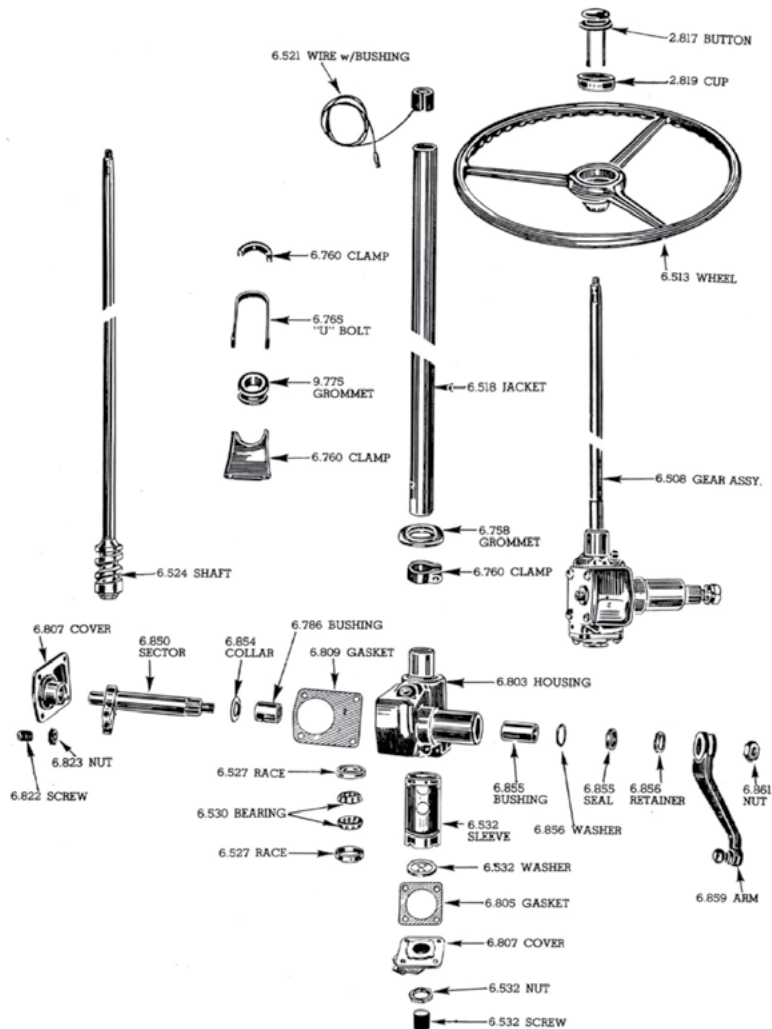

**1937-40 TRUCK AND 1937 GB SERIES PASSENGER CAR**

Returns require a return authorization number—call first. • Product pricing & availability subject to change.



**WARNING:** Cancer and Reproductive Harm — [www.P65Warnings.ca.gov](http://www.P65Warnings.ca.gov)



**HORN CONTACT PARTS**

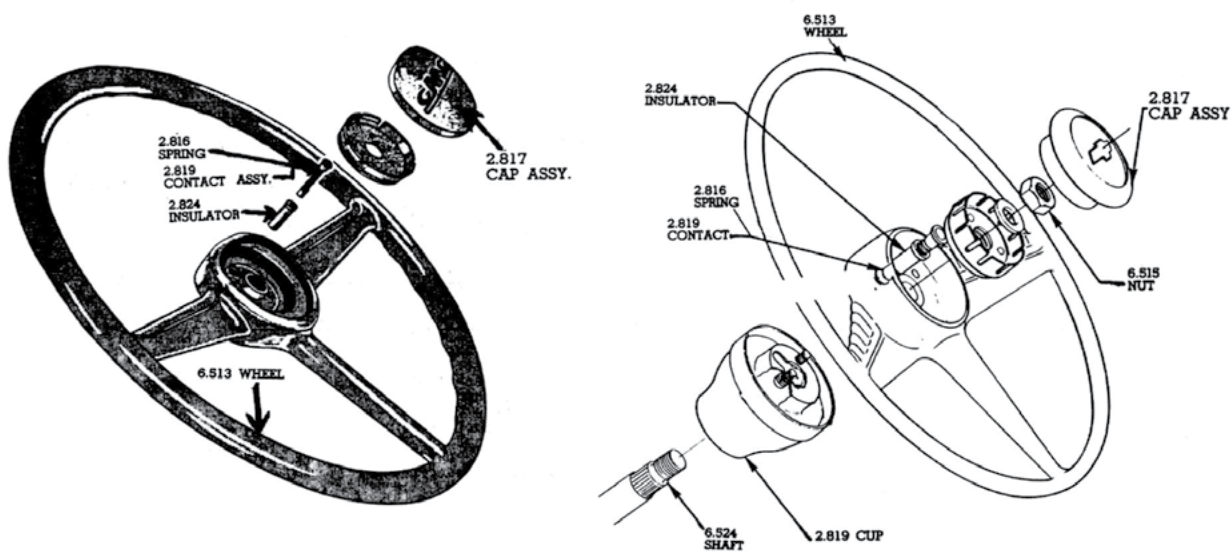

*ILLUSTRATIONS ARE COMPLETE ASSEMBLIES  
SEE TEXT FOR AVAILABILITY*

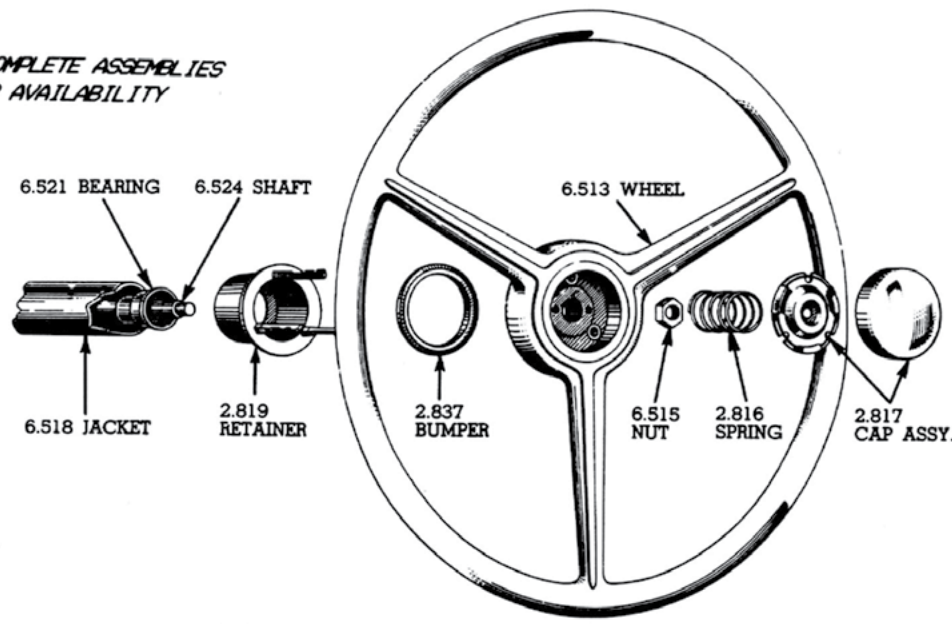

**HORN CONTACT PARTS—CONVENTIONAL TRUCK**

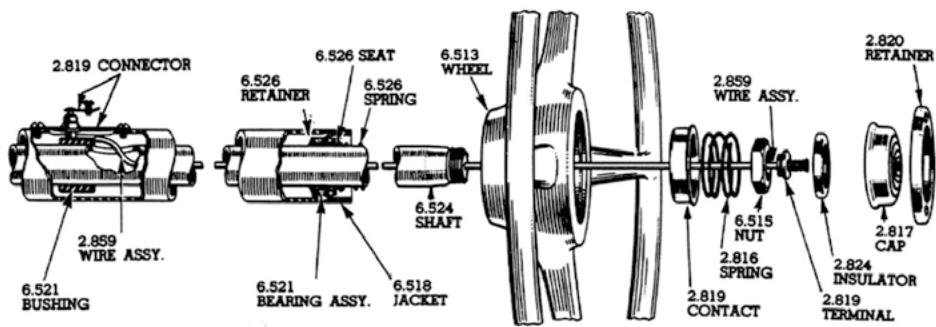

**HORN CONTACT PARTS—CAB-OVER-ENGINE**

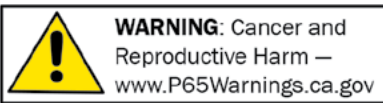

**WARNING:** Cancer and Reproductive Harm — [www.P65Warnings.ca.gov](http://www.P65Warnings.ca.gov)

Chemicals shipped domestic ground only (Lower 48 states only). No international shipping.  
**Phone: (360) 816-0211 • (800) 999-CHEV (2438) • [www.chevsofthe40s.com](http://www.chevsofthe40s.com)**

**SECTION 190T  
STREET ROD PARTS**

**Power Steering Conversion Kit**



**5880723 .....47-59**  
Chevy truck. For use with late model 1969-87 Chevy 2WD Saginaw steering box with 13/16" 36 spline input shaft.

Note: if you have a steering box with 3/4" 30 spline, use our u-joint part number FR1733DD. 6.859 -0 ..... **\$298.00 SET** ⚠

**Pitman Arm**



**5880723S .....47-54**  
Power steering conversion kit, for stock suspension. Fits 1969-87 Chevy 2WD truck power steering box with a 13/16"-36 spline input shaft. 6.859 -0.15 ..... **\$91.00 EA** ⚠

**SECTION 190T  
RESTORATION PARTS**

**Steering Wheel**



**755896 .....41-46**  
Black. Original in 41-45. Fits 36 spline 3/4" shaft. 6.513 -0.15 ..... **\$173.75 EA** ⚠

**755896BR .....41-46**  
Brown. Original for 1946. 6.513 -0.15 ..... **\$196.75 EA** ⚠

**Steering Wheel, cont.**



**756084A .....47-53**  
Black. Superior quality. Shaft size: 11/16", 36 splines. Chevy & GMC 6.513 -0.15 ..... **\$173.75 EA** ⚠



**758625A ..... 54**  
Black. Superior quality, beautiful finish. Chevy & GMC 6.513 -0.15 ..... **\$234.50 EA** ⚠

**Steering Column Clamp**



**594670 .....34-40**  
U-bolt with fasteners. 6.765 -0.15 ..... **\$25.00 EA** ⚠



**3657031 .....41-46**  
U-bolt with fasteners. 6.765 -0.15 ..... **\$24.50 EA** ⚠

**Steering Column Insulator**



**3681057A .....34-46**  
Steering column to dash, brown exc COE. 6.758 -0 ..... **\$13.50 EA** ⚠



**598145 .....34-46**  
Steering column to dash, black exc COE. 6.758 ..... **\$2.00 EA** ⚠



**3685524 .....47-53**  
Steering column to dash, black exc COE. 6.758 -0 ..... **\$3.00 EA** ⚠

**Steering Column Insulator, cont.**



**3700190 ..... 54**  
Steering column to dash, black 6.758 -0.15 ..... **\$3.00 EA** ⚠

**Grommet**



**357507 .....29-46**  
Steering column at floor (exc COE). 6.758 -0.15 ..... **\$52.00 EA** ⚠



**3682871 .....47-54**  
Steering column at firewall (floor shift). 6.758 -0.2 ..... **\$4.00 EA** ⚠



**3685928 .....47-54**  
Steering column with metal core & sponge seal #3682871 at firewall (floor shift). Chevy & GMC 6.758 -0.15 ..... **\$14.75 EA** ⚠

..... **\$14.75 EA** ⚠



**3685928A .....47-54**  
Steering column without metal core at firewall (floor shift). Chevy & GMC 6.758 -0.15 ..... **\$45.00 EA** ⚠



**3687204 .....47-54**  
Sponge seal. Steering column at firewall (column shift). 6.758 -0.3 ..... **\$6.00 EA** ⚠

..... **\$6.00 EA** ⚠



**3687205 .....48-54**  
Steering column grommet with metal core & sponge seal #3687204 at firewall (column shift). 6.758 -0.15 ..... **\$13.50 EA** ⚠

**Rubber Ring**



**755899 .....41-46**  
Anti-rattle under steering wheel. 2.819 -0.3 ..... **\$4.00 EA** ⚠

# Section 190T: Steering Columns, Steering Wheels, Shafts, Rebuild Kits, Steering Components & Related

## Bushing w/ Horn Wire



**1854761.....31-40**  
Bushing under steering wheel w/ horn wire.

Also fits 36-40 GMC 6.521-0

..... **\$62.25 EA** ⚠️

## Bearing w/ Horn Wire



**264887.....41-46**  
Bearing under steering wheel, w/ horn wire.  
6.521-0.15

..... **\$23.00 EA** ⚠️



**270255.....47-54**  
Bearing under steering wheel, w/ horn wire. Chevy & GMC 6.521-0.15

..... **\$48.00 EA** ⚠️

## Steering Gear Shaft w/ Worm

**264279.....38-40**  
Worm Gear & Shaft (All Utility exc. COE)  
6.524-0.4

..... **\$250.00 EA** ⚠️



**267793A.....41-46**  
Steering box worm gear assembly w/ shaft  
6.508-0.15

..... **\$235.00 EA** ⚠️

**267888.....41-46**  
Worm Gear & Shaft Utility exc COE  
15000.000-0

..... **\$250.00 EA** ⚠️

**267879.....42-46**  
Wormgear & shaft. Fits 1/2T and 3/4T,  
BK, BL, BM, CK, DP, DR. 6.524-0

..... **\$250.00 EA** ⚠️

**270260.....47-53**  
Worm Gear & Shaft 2T & School Bus  
Chassis (exc. COE) 15000.000-0

..... **\$250.00 EA** ⚠️

## Steering Gear Shaft w/ Worm, cont.



**270927A.....47-53**  
Steering box worm gear assembly w/ shaft  
6.508-0.15

..... **\$144.25 EA** ⚠️

## Steering Gear Overhaul Kit

Note: Steering gear overhaul kits do not include worm gear, pitman shaft or sector shaft. Those items sold separately.



**264277A.....38-40**

Includes roller bearings. 6.524-0.4

..... **\$250.00 KIT** ⚠️



**267880A.....41**

Includes gaskets, seals, bushings, worm gear balls, races and bearings. 6.524-0.2

..... **\$150.00 KIT** ⚠️



**267880B.....42-46**

Exc. COE. 6.524-0.3

..... **\$207.00 KIT** ⚠️



**5060231A.....47-54**

Includes bushings, worm gear balls, races and bearings. 6.524-0.3

..... **\$192.00 SET** ⚠️

## Bearings & Balls For Steering Worm Gear



**261866B.....37-40**

Thrust bearing (2) & race (2). 6.530-0.15

..... **\$44.00 SET** ⚠️



**266741.....41**

Balls in ball nut steering worm gear (30 piece).  
0.0025 dia. 6.844-0.4

..... **\$13.75 SET** ⚠️



**179291B.....41-54**

Thrust bearing (2) & race (2). 6.530-0.3

..... **\$120.00 SET** ⚠️



**267689.....41-59**

Worm gear adjuster nut for lowering bearing  
6.830-0.15

..... **\$99.75 EA** ⚠️



**206800.....42-57**

Balls in ball nut steering worm gear (30 piece).  
6.844-0

..... **\$8.25 SET** ⚠️

## Gasket



**269298.....41-46**

Steering gear side cover. 6.809-0.3

..... **\$4.50 EA** ⚠️

## Pitman Shaft



**609936.....38-40**

Steering gear. 6.850-0.4

..... **\$153.50 EA** ⚠️

**609937.....41-46**

Pitman Shaft (Steering Gear) 6.850-0

..... **CALL** ⚠️



**WARNING:** Cancer and Reproductive Harm —  
www.P65Warnings.ca.gov

Chemicals shipped domestic ground only (Lower 48 states only). No international shipping.

Phone: (360) 816-0211 • (800) 999-CHEV (2438) • www.chevsofthe40s.com

# Section 190T: Steering Columns, Steering Wheels, Shafts, Rebuild Kits, Steering Components & Related

## Pitman Shaft Screw



**266678.....41-57**  
Adjuster for pitman shaft. 6.822-0  
..... **CALL** ⚠

## Pitman Shaft Bushing



**266316.....34-54**  
Pitman shaft.  
Length=1.350",  
I.D.=1.130",  
O.D.=1.250". 6.786-0.3  
..... **\$25.25 EA** ⚠

## Pitman Shaft Seal



**262155.....37-57**  
This is a pitman shaft seal for the steering box. 6.855-0.1  
..... **\$10.00 EA** ⚠

## Drag Link Rebuild Kit



**608840.....32-59**  
Tie rod end rebuild kit, plugs, springs, seats, exc. 53-59 drag link. 6.874-0  
..... **\$30.00 PR** ⚠

## Drag Link



**609749.....37-46**  
Includes part #608840 (Tie rod end rebuild kit). Fits 37-46 1/2Ton, 3/4Ton, 1Ton and 1-1/2Ton vehicles. 6.870-0.15  
..... **\$118.75 EA** ⚠

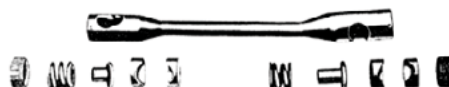

**3699489.....47-52**  
Includes Drag Link Kit #608840.  
6.870-0.15  
..... **\$107.75 EA** ⚠

## Drag Link, cont.



**3696469.....53-54**  
With tie rod ends. 6.870-0.15  
..... **\$124.75 EA** ⚠

## Drag Link Seals



**3705009.....32-52**  
2-1/4 in. long, rubber replacement.  
6.886-0.15  
..... **\$20.25 SET** ⚠



**3705009A.....32-52**  
2-7/8 in. long, metal as original. 6.886-0  
..... **\$22.00 SET** ⚠

## Long Tie Rod



**367528.....32-54**  
Rod only (40-54 1/2T& 3/4T). 43-1/4" long. 6.230-0  
..... **\$40.00 EA** ⚠

## Tie Rod End



**374226R.....34-54**  
1/2T& 3/4T (replacement type, non-tapered. Complete w/ ball) right. 6.233-0.15  
..... **\$45.00 EA** ⚠

**374227L.....34-54**  
1/2T& 3/4T (replacement type, non-tapered. Complete w/ ball), left. 6.233-0.15  
..... **\$45.00 EA** ⚠

## Odds & Ends

Please call for availability on all Odds & Ends parts; once part is sold, it may no longer be in stock.

**374226N.....32-56**  
Tie rod end left (4-59/64 in) (25/36-16 right hand thread) Stamped R. Fits 32-34 all exc CC & DC, 35-38 Pass, COMM exc EC, FC, GB & HB, 39-42 COMM, 46-56 1/2T & 3/4T exc DD. 6.233-0.4  
..... **\$35.00 EA** ⚠

**374227N.....32-56**  
Tie rod end. Left side. (4-59/64in.) (25/36-16 left hand thread) Stamped L. Fits 32-34 all exc CC & DC, 35-38 Pass, COMM exc EC, FC, GB & HB, 39-42 COMM, 46-56 1/2T & 3/4T exc DD. 6.233-0.4  
..... **\$35.00 EA** ⚠

**373781.....34-36**  
Steering connecting rod (drag link)  
6.870-0.4  
..... **\$75.00 EA** ⚠

**3667227.....37-50**  
Steering arm fits 1-1/2 ton left or right  
6.103-0  
..... **\$25.00 EA** ⚠

**753325.....38-40**  
Steering wheel fits all except JA, KA, KB, KH & COE (Used) 6.513-0  
..... **\$100.00 EA** ⚠

**266667.....41**  
Ball nut for steering gear, fits all commercial & utility exc COE 15000.000-0.4  
..... **\$45.00 EA** ⚠

**3678194.....46-50**  
Steering knuckle stop NOS (fits 46 PP, PR, PS; 47-50 DD, SBC & 2T) use with 3681101 forged I-beam 6.009-0  
..... **\$15.00 EA** ⚠

**756084U.....47-53**  
Steering Wheel Used 4000.000-0.4  
..... **\$70.00 EA** ⚠

**3703563.....53-57**  
Steering knuckle (spindle) fits 3/4T & 1T 15000.000-0.4  
..... **\$65.00 EA** ⚠

**3701357U.....54-57**  
Steering wheel hub without single level hole used 6.512-0  
..... **\$20.00 EA** ⚠



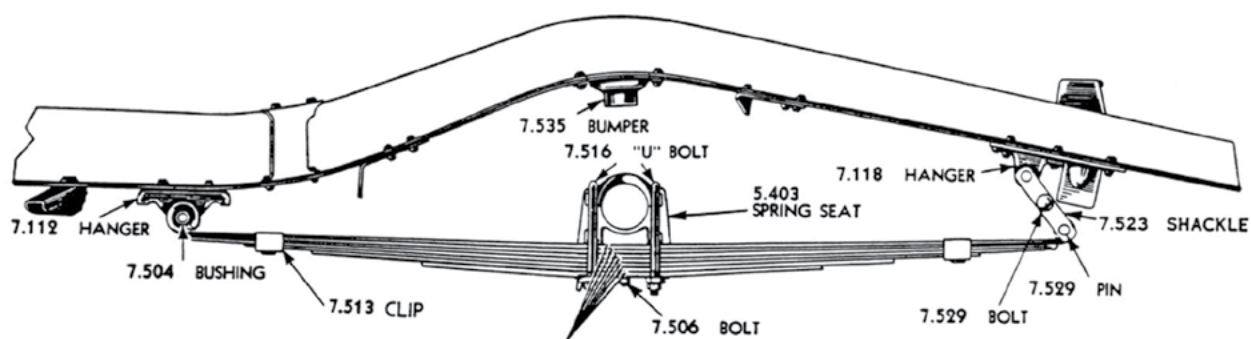

**REAR SPRING AND PARTS**

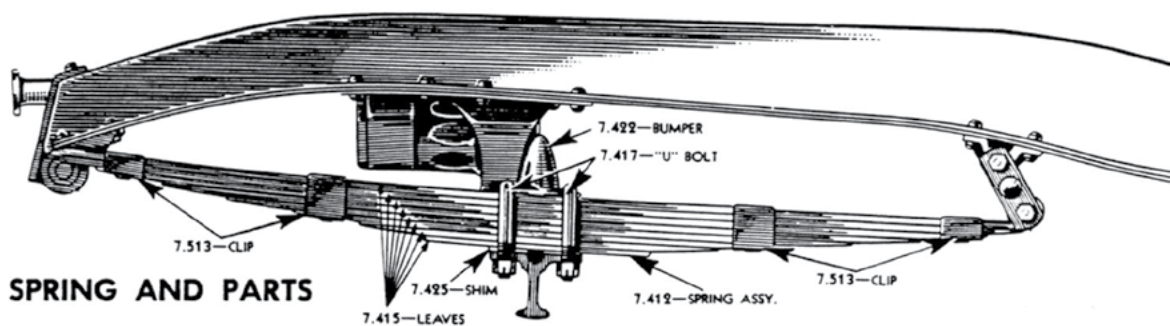

**FRONT SPRING AND PARTS**

ILLUSTRATIONS ARE COMPLETE ASSEMBLIES.  
SEE TEXT FOR AVAILABILITY.

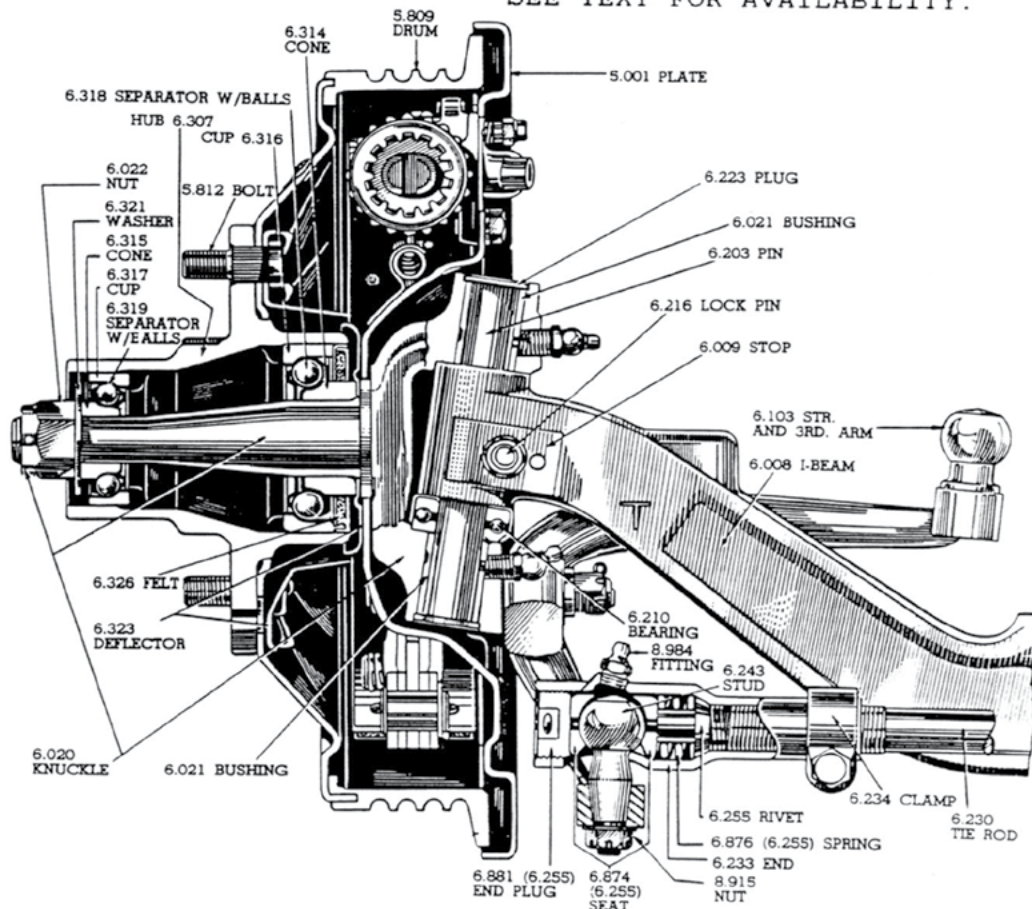

**FRONT AXLE—CONVENTIONAL TRUCK (EXC. HVY. DUTY)**



**WARNING:** Cancer and Reproductive Harm — [www.P65Warnings.ca.gov](http://www.P65Warnings.ca.gov)

Chemicals shipped domestic ground only (Lower 48 states only). No international shipping.  
**Phone: (360) 816-0211 • (800) 999-CHEV (2438) • [www.chevsofthe40s.com](http://www.chevsofthe40s.com)**

**SECTION 200T  
STREET ROD PARTS**

**IFS Mustang II Kit Weld In**

Mustang II Suspension kits come complete with crossmember, paintable tubular upper and lower full A-frame style control arms, 11" five lug rotors, bearings and seals, springs, shocks, stock spindles, GM calipers with brackets and pads, manual rack and pinion with tie rod ends and bushings, rubber spring cushions, spindle nuts w/washers, and all mounting hardware.

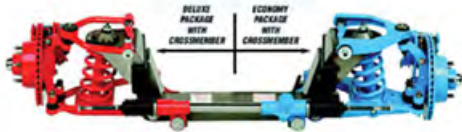

**HEIDTSIFS01.....37-54**  
Independent Front Suspension Kit. Heidt's weld in. Tubular A-arms with crossmember. 6.008-0 ..... **\$2,305.75 KIT** ⚠️

**HEIDTSIFS02.....37-54**  
Independent front suspension kit Heidt's weld in. Tubular A-arms, without crossmember. 6.008-0.15 ..... **\$2,106.00 KIT** ⚠️

**IFS Mustang II Crossmember Weld In**

**CX305E.....37-39**  
Heidt's Mustang II weld in crossmember. 6.008-0 ..... **\$535.00 EA** ⚠️

**CX306E.....40-46**  
Heidt's Mustang II weld in crossmember. 6.008-0 ..... **\$535.00 EA** ⚠️

**CX307E.....47-54**  
Heidt's Mustang II weld in crossmember. For single lower pivot. 6.008-0 ..... **\$535.00 EA** ⚠️

**Shock Conversion Kit**



**3700440B.....37-49**  
This conversion kit includes 4 gas shocks, upper and lower steel shock mounts, and hardware for front and rear shocks. This was designed for 1947-1949 1/2 ton trucks, you can use this on 1937-1946 1/2 ton trucks as well. You will need to drill holes in your frame rail for the upper shock mounts. There is no template to drill the frame available. 7.395-0.15 ..... **\$375.00 SET** ⚠️

**Sway Bar**



**3683028.....47-54**  
Sway bar, front, complete, 1-1/8in. diameter w/ links and bushings 7.241-0.15 ..... **\$180.25 SET** ⚠️

**SECTION 200T  
RESTORATION PARTS**

**Shocks**



**1054144.....34-46**  
Left front, single action (#1430CA) \$100 core 7.345-0 ..... **\$244.00 EA** ⚠️



**1054146.....34-46**  
Right front, single action (#1430DA) \$100 core 7.345-0 ..... **\$244.00 EA** ⚠️

**Shocks, cont.**



**1072707.....34-50**  
Right front, dual action (#1730-A) \$75 core.(exc COE) 7.345-0.15 ..... **\$249.75 EA** ⚠️

**1072708.....34-50**  
Left front, dual action (#1730B) \$75 core 7.345-0.15 ..... **\$249.75 EA** ⚠️



**1054144.....47-50**  
Right front, single action (exc HP, HR, HS) (#1430CA) \$100 core 7.345-0 ..... **\$244.00 EA** ⚠️



**1054146.....47-50**  
Left front, single action (exc HP, HR, HS) (#1430DA) \$100 core 7.345-0 ..... **\$244.00 EA** ⚠️



**5516237G.....50-54**  
Front, 1/2Ton & 3/4Ton 7.345-0 ..... **\$97.25 PR** ⚠️

**Shock Absorber Fluid**



**603489S.....ALL**  
Shock Absorber Fluid. 6.386-0 ..... **\$12.00 QT** ⚠️

**Tube Shock Mounts**



**3655328.....47-54**  
Lower rear, left or right, 1/2Ton (replacement for 50-54). 7.395-0.15 ..... **\$23.25 EA** ⚠️

**Tube Shock Mounts, cont.**



**3693687.....47-54**  
Lower front, left  
7.395 -0.15 .....  
**\$43.75 EA** ⚠️



**3693688.....47-54**  
Lower front, right  
7.395 -0.15 .....  
**\$43.75 EA** ⚠️



**3700440.....47-54**  
Upper front or rear. Fits  
1/2Ton (replacement  
for 50-54). 7.395 -0.15  
... **\$35.25 EA** ⚠️

**Shock Link**



**043032A.....30-49**  
9-5/16 in. overall 7.355 -0  
**CALL** ⚠️

**Bushings Shock**



**041133.....30-49**  
Shock link. 1/2Ton &  
3/4Ton. 7.388 -0.15  
..... **\$13.00 PR** ⚠️



**041133B.....30-49**  
Shock link single action  
w/ brass bushings, pins  
& cotter keys for beam  
axle. Superior. 7.388 -0  
..... **\$16.00 PR** ⚠️



**043816.....33-53**  
Shock link double action shock 33-46 all,  
47-49 1/2Ton, 3/4Ton, 1Ton & 50-55  
Double Duty. 7.388 -0 ..... **\$9.50 SET** ⚠️



**041153.....33-54**  
In Shock Arm (rubber)-  
double Action 7.377 -0  
..... **\$9.50 EA** ⚠️



**3708378.....50-57**  
Shock, rubber, w/ washers & nuts. 7.388 -0  
..... **\$17.25 SET** ⚠️

**Bushing Sway Bar**



**350146.....39-46**  
Sway bar shaft (steel  
bushed rubber) use  
with #3501467  
7.240 -0.15 ..... **\$60.00 PR** ⚠️



**3501467.....39-46**  
Sway bar (rubber) use  
with #350146 (2 piece)  
7.240 -0.15  
..... **\$19.75 SET** ⚠️



**3708378.....50-54**  
Sway bar rubber links w/ washers & nuts  
7.388 -0 ..... **\$17.25 SET** ⚠️

**King Pins**



**602691.....29-39**  
1/2Ton, 34-39 3/4Ton & 1Ton 6.203 -0.15  
..... **\$55.00 PR** ⚠️

**602690.....40**  
1/2Ton, 3/4Ton & 1Ton 6.203 -0.15  
..... **\$80.00 PR** ⚠️

**605121.....41-54**  
1/2Ton 6.203 -0.15  
..... **\$55.25 PR** ⚠️

**601019.....46-52**  
46-52 3/4Ton, 1Ton 6.203 -0.15  
..... **\$101.25 PR** ⚠️

**3691111.....46-57**  
Double Duty, 2Ton, 46-47 1-1/2Ton, 48-  
57 1-1/2Ton heavy duty 6.203 -0  
..... **CALL** ⚠️

**3704112.....53-54**  
3/4Ton, 1Ton, 1-1/2Ton (exc Double  
Duty, School Bus chassis, Heavy Duty)  
6.203 -0.15  
..... **\$69.99 PR** ⚠️

**Shackles**



**604478.....34-46**  
Front 34-36 all, 37-40 (exc COE) 41-46  
1/2Ton & 3/4Ton 7.523 -0 .....  
**\$139.50 SET** ⚠️  
**609071.....39-54**  
Front COE & 41-46 1Ton, 1-1/2Ton, 2Ton  
7.436 -0  
..... **\$151.75 SET** ⚠️

**3847459.....47-54**  
Front (1/2Ton & 3/4Ton) 7.436 -0.15  
..... **\$106.75 SET** ⚠️



**3847460.....47-56**  
Front 1Ton & larger exc. Double Duty &  
COE 7.436 -0.15 ..... **\$115.50 L&R** ⚠️

**Shackle Rebuild Kit**



**373199.....30-54**  
Does 2. Pins, bushings & seals, 1/2Ton &  
3/4Ton (16 pcs). 7.427 -0.15 .....  
**\$80.00 SET** ⚠️

**3653273.....39-54**  
Does 2, pins, bushings, seals, 39-40 COE,  
41-54 1Ton, 1-1/2Ton, 2Ton, Double Duty  
(16 piece) 7.427 -0.15  
..... **\$103.00 SET** ⚠️

**Seals Shock**



**593705.....34-54**  
Rubber for steel bushed  
shackles (8 pcs).  
7.443 -0.3  
..... **\$14.75 SET** ⚠️

**Spring Bolt & Bushing**



**593990B.....37-54**  
Fixed end front springs,  
1/2Ton & 3/4Ton (2  
piece) 7.428 -0.15  
..... **\$69.00 SET** ⚠️

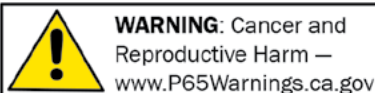

**WARNING:** Cancer and  
Reproductive Harm —  
www.P65Warnings.ca.gov

Chemicals shipped domestic ground only (Lower 48 states only). No international shipping.

**Phone: (360) 816-0211 • (800) 999-CHEV (2438) • www.chevsofthe40s.com**

**Spring Bolt & Bushing, cont.**



**3657393.....39-54**  
Fixed end front spring,  
41-54 1Ton, 1-1/2Ton  
& 2Ton (39-40 COE)  
7.428 -0.15

..... **\$66.25 PR** ⚠

**Grease Fitting**



**110347.....ALL**  
1/4 in. x 28 taper  
thread, 90 degree.  
8.984 -0.3

..... **\$1.25 EA** ⚠



**191758.....ALL**  
1/8 in. national pipe,  
straight. 8.984 -0.4

..... **\$1.69 EA** ⚠

**Axle Bumper**



**3653084.....40-54**  
Axle (exc Double Duty  
& 53-54 3/4Ton, 1Ton,  
1-1/2Ton & 2Ton)  
7.422 -0.15

..... **\$20.00 SET** ⚠



**3700034.....52-57**  
52-54 1Ton, 53-54  
3/4Ton, 55-57 all.  
7.535 -0.15

..... **\$32.25 SET** ⚠

**U-Bolt**



**601231.....34-54**  
W/ nuts, front axle to  
spring, 34-49 1/2Ton,  
3/4Ton, 1Ton & 50-54  
1/2Ton 7.417 -0.15

..... **\$16.00 EA** ⚠

**Bolt**



**1288224.....ALL**  
Leaf spring center (exc utility vehicle) (2  
pcs). 7.506 -0.2

..... **\$9.75 SET** ⚠

**Front Leaf Spring**

Note: Spring Order requires purchase of fixed end pins & bushings (pressed in free).

Oversize shipping charges apply to all Front Leaf Springs. Please call for rate.

**599316.....39-46**  
1/2Ton (7 leaves) 7.412 -0.15

..... **CALL** ⚠

**3656610.....41-46**  
3/4Ton (8 leaves) 7.412 -0.15

..... **CALL** ⚠

**3702793.....47-54**  
1/2Ton & 3/4Ton, exc Double Duty (8  
leaves) 7.412 -0.15

..... **CALL** ⚠

**Liner**



**3699910T.....37-54**  
For leaf springs. 1-3/4" wide x 20 feet  
long. 7.495 -0.15

..... **\$62.75 SET** ⚠

**Odds & Ends**

Please call for availability on all Odds & Ends parts; once part is sold, it may no longer be in stock.

**1054146U.....50**  
Shock front left used fits Double Duty  
7.345 -0.4

..... **\$75.00 EA** ⚠





# Corvette C4-IFS & IRS Installation Kits for 47-53 Chevy Trucks

Now you can have the ride, superior handling, cornering and braking provided only by the advanced technology built into the Corvette suspension.



**We offer quality kits to adapt the late model ('84-'87 and '88-'95) Corvette front and rear independent suspensions to your '47-'55 Chevy truck. (Suspension not included.)**



These kits are designed to fit your frame. All brackets are laser cut from cold rolled steel and heli-arc welded for strength and unsurpassed good looks.

These kits utilize Corvette C-4 front and rear suspension components mounted to your frame using the stock Corvette geometry. The real bonus is this system uses the stock Corvette Power Rack and Pinion Steering Unit as designed by

GM, eliminating "bump steer" problems inherent with units from vehicles designed in the '70s with light weight vehicles and economy in mind. You can get GM sports car handling on your GM manufactured truck. All the Corvette suspension components are manufactured from forged aluminum which allows you to decrease vehicle weight while also maintaining strength and a solid suspension.



Not only will you be amazed at how well your truck rides but how fun it will be drive with a Corvette front and rear suspension installed. And let's not forget 4-wheel disc brakes designed to mount to your suspension.

Available **Aldan Eagle coilover shocks** for front or rear allow you to adjust the ride to your liking with 6-position adjustable compression damping and spring rate adjustment also. Rugged construction and combination of oil and gas charging incorporated in each shock are only part of the reason we recommend them with our IFS and IRS kits. Kits complete with instructions and all hardware.



You'll enjoy the handling and new life brought to your truck with these very affordable suspension kits for years to come.

### FRONT CROSSMEMBER ⚠

SUSCORF1	84-87 C-4 IFS-front without coilover shocks (see below) . . . . .	\$895.00
SUSCORF2	88-96 C-4 IFS-front without coilover shocks (see below) . . . . .	\$945.00

### REAR CROSSMEMBER ⚠

SUSCORR1	84-87 C-4 IRS-rear without coilover shocks (see below) . . . . .	\$750.00
SUSCORR2	88-96 C-4 IRS-rear without coilover shocks (see below) . . . . .	\$765.00

### ALDAN COILOVER SHOCKS ⚠

SHOCKF1	Front shock . . . . .	\$585.00 pr
SHOCKF2	Front shock w/ chrome springs . . . . .	\$615.00 pr
SHOCKF3	Front shock w/ polished housing . . . . .	\$650.00 pr
SHOCKF4	Front shock w/ chrome sprints & polished housing . . . . .	\$750.00 pr
SHOCKR1	Rear shock. . . . .	\$585.00 pr
SHOCKR2	Rear shock w/ chrome springs . . . . .	\$725.00 pr
SHOCKR3	Rear shock w/ polished housing . . . . .	\$705.00 pr
SHOCKR4	Rear shock w/ chrome sprints & polished housing . . . . .	\$750.00 pr

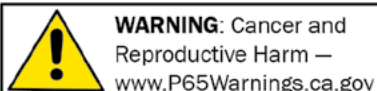

**WARNING:** Cancer and Reproductive Harm — [www.P65Warnings.ca.gov](http://www.P65Warnings.ca.gov)

Chemicals shipped domestic ground only (Lower 48 states only). No international shipping.

**Phone: (360) 816-0211 • (800) 999-CHEV (2438) • [www.chevsofthe40s.com](http://www.chevsofthe40s.com)**

**SECTION 210T  
STREET ROD PARTS**

**Lowering Blocks**

Lowering blocks are available with square or round u-bolts. Please specify when ordering.



- 373201A** .....**37-54**  
1", w/ u-bolts. 7.427 -0.2 .....  
**\$85.00 SET** ⚠
- 373201B** .....**37-54**  
2", w/ u-bolts. 7.427 -0.15 .....  
**\$85.00 SET** ⚠
- 373201C** .....**37-54**  
3", w/ u-bolts. 7.427 -0 .....  
**\$90.00 SET** ⚠

**Shock Conversion Kit**



- 3700440B** .....**37-49**  
This conversion kit includes 4 gas shocks, upper and lower steel shock mounts, and hardware for front and rear shocks. This was designed for 1947-1949 1/2 ton trucks, you can use this on 1937-1946 1/2 ton trucks as well. You will need to drill holes in your frame rail for the upper shock mounts. There is no template to drill the frame available. 7.395 -0.15 .....  
**\$375.00 SET** ⚠

**Rear Leaf Spring**

Note: Spring order requires purchase of fixed end pins & bushings (pressed in free).

**SECTION 210T  
RESTORATION PARTS**

**Shock Link**



- 043031A** .....**30-39**  
8in. overall, exc CC. 7.355 -0.4 .....  
**\$20.00 EA** ⚠

**Single Action Shock**



- 1054421** .....**34-49**  
Left rear, 1/2Ton, #1430MA (\$50 core). 7.345 -0.15 .....  
**\$335.00 EA** ⚠
- 535256** .....**34-49**  
Right rear, 1/2Ton, #1430LP (core \$50). 7.345 -0.15 .....  
**\$335.00 EA** ⚠

**Dual Action Shock**

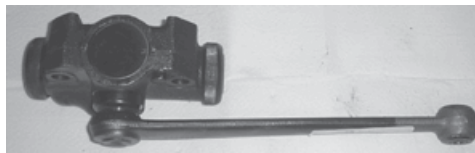

- 1054424** .....**34-47**  
1/2 Ton right rear, #1731-T (\$100 core). 7.345 -0.15 .....  
**\$200.00 EA** ⚠



- 1054425** .....**34-47**  
1/2 Ton left rear, #1731-U (\$100 core). 7.345 -0.15 .....  
**\$200.00 EA** ⚠
- 1054424** .....**48-49**  
Left rear, #1731-T (\$100 core). 7.345 -0.15 .....  
**\$220.00 EA** ⚠
- 1054425** .....**48-49**  
1/2 Ton Right rear, #1731-U (\$100 core). 7.345 -0.15 .....  
**\$220.00 EA** ⚠

**Gas Shocks**



- 5394579G** .....**47-54**  
Rear, 3/4Ton (original 50-54 will fit 47-49 w/ conversion). 7.345 -0.15 .....  
**\$58.25 SET** ⚠
- 5516239G** .....**47-54**  
Rear, 1/2Ton (original 50-54 will fit 47-49 w/ conversion). 7.345 -0 .....  
**\$69.00 PR** ⚠

**Tube Shock Mounts**



- 3655328** .....**47-54**  
Lower rear, left or right, 1/2Ton (replacement for 50-54). 7.395 -0.15 .....  
**\$23.25 EA** ⚠



- 3700440** .....**47-54**  
Upper front or rear. Fits 1/2Ton (replacement for 50-54). 7.395 -0.15 .....  
**\$35.25 EA** ⚠

**Bushing Shock Link**



- 041133** .....**30-49**  
Shock link. 1/2Ton & 3/4Ton. 7.388 -0.15 .....  
**\$13.00 PR** ⚠



- 041133B** .....**30-49**  
Shock link single action w/ brass bushings, pins & cotter keys for beam axle. Superior. 7.388 -0 .....  
**\$16.00 PR** ⚠



- 043816** .....**33-53**  
Shock link double action shock 33-46 all, 47-49 1/2Ton, 3/4Ton, 1Ton & 50-55 Double Duty. 7.388 -0 .....  
**\$9.50 SET** ⚠

**Bushing Shock**



- 041153** .....**33-53**  
In shock arm, rubber, double action. 7.377 -0 .....  
**\$9.50 EA** ⚠



- 3708378** .....**50-57**  
Shock, rubber, w/ washers & nuts. 7.388 -0 .....  
**\$17.25 SET** ⚠

Returns require a return authorization number—call first. • Product pricing & availability subject to change.



**Bushing Rear Spring Pivot**



**3652182A** ..... **48-54**  
Bolt w/ nut, rear end to spring pivot,  
1/2Ton. 5.403 -0.15 ..... **\$33.00 PR** ⚠

**Spring Pivot Bolt & Bushing**



**593990B** ..... **34-54**  
Front of rear spring, 1/2Ton. 7.428 -0  
..... **\$69.00 PR** ⚠

**Seals Rear End To Spring Pivot**



**597267** ..... **38-54**  
Rear end to spring pivot  
bolt (4 ea). 5.404 -0.3  
..... **\$15.75 SET** ⚠

**Rear Shackles**



**350441** ..... **34-54**  
1/2Ton & 3/4Ton (2 pcs). 7.523 -0  
**\$105.00 SET** ⚠

**Shackle Rebuild Kit**



**373199** ..... **30-54**  
Does 2. Pins, bushings & seals, 1/2Ton &  
3/4Ton (16 pcs). 7.427 -0.15 ..... **\$80.00 SET**  
⚠



**3725531B** ..... **33-55**  
3/4Ton, 1Ton & Utility (exc Panel). 7.573 -0  
..... **\$143.00 SET** ⚠

**Grease Fitting**



**110347** ..... **ALL**  
1/4 in. x 28 taper  
thread, 90 degree.  
8.984 -0.3

..... **\$1.25 EA** ⚠



**191758** ..... **ALL**  
1/8 in. national pipe,  
straight. 8.984 -0.4

..... **\$1.69 EA** ⚠

**Shackle Seals**



**593705** ..... **34-54**  
Rubber for steel bushed  
shackles (8 pcs).  
7.443 -0.3

..... **\$14.75 SET** ⚠

**Rear Axle Bumper**



**365627** ..... **34-46**  
1/2Ton 7.535 -0.15

..... **\$32.25 PR** ⚠



**3700034** ..... **52-57**  
52-54 1Ton, 53-54  
3/4Ton, 55-57 all.  
7.535 -0.15

..... **\$32.25 SET** ⚠

**U-Bolt**



**602509** ..... **31-46**  
Rear axle to spring, 1/2Ton. 7.417 -0.15

..... **\$16.00 EA** ⚠



**602509R** ..... **37-46**  
Round U-Bolt W/ nuts,  
spring to axle, fits 37-46  
truck with rear original  
cast iron bracket

7.516 -0.15

..... **\$16.00 EA** ⚠



**601231** ..... **47-54**  
W/ nuts, rear axle to spring pivot, 1/2Ton.  
7.417 -0.15

..... **\$16.00 EA** ⚠

**Bolt**



**1288224** ..... **ALL**  
Leaf spring center (exc utility vehicle) (2  
pcs). 7.506 -0.2 ..... **\$9.75 SET** ⚠

**Teflon Liner**



**3699910T** ..... **37-54**  
For leaf springs. 1-3/4" wide x 20 feet  
long. 7.495 -0.15 ..... **\$62.75 SET** ⚠

**Rear Leaf Spring**

Oversize shipping charges apply to all Rear  
Leaf Springs. Please call for rate.

**3659368** ..... **36-46**  
1/2Ton (8 leaves). 7.503 -0.15

..... **CALL** ⚠

**SPECIFY65T** ..... **37-54**

Original springs will allow severe axle wrap  
w/ the torque tube removed and these are  
needed for an open drive shaft. Also helps  
to center axle in wheel wells.

Can be made with arch to lower vehicle.

7.503 -0.15

..... **CALL** ⚠

**3656559** ..... **41-54**  
3/4Ton (7 leaves). 7.503 -0.15

..... **CALL** ⚠

**3683317** ..... **47-54**  
1/2Ton (8 leaves). 7.503 -0.15

..... **CALL** ⚠

**Odds & Ends**

Please call for availability on all Odds & Ends  
parts; once part is sold, it may no longer be in  
stock.

**3656558** ..... **46-47**  
U-bolt fits 1-1/2Ton, School bus chassis &  
panel 7.516 -0.4 ..... **\$20.00 EA** ⚠



**WARNING:** Cancer and  
Reproductive Harm —  
www.P65Warnings.ca.gov

Chemicals shipped domestic ground only (Lower 48 states only). No international shipping.

**Phone: (360) 816-0211 • (800) 999-CHEV (2438) • www.chevsofthe40s.com**

**SECTION 220T  
STREET ROD PARTS**

**Custom Wheel Artillery (Bare)**



**AB** ..... **ALL**  
Bare Steel Artillery Rim. 15" Only. Specify width and backspace. Available in 5,6,7,8,10,12,14 inch widths. 5x4-3/4", 6x5-1/2" Chevy or 5x4-1/2" Ford lug patterns. -0 .....starting at **\$157.00 EA** ⚠

**Custom Wheel Artillery (Chrome)**



**AC** ..... **ALL**  
All Chrome Artillery Rim. 15" Only. Specify size, width and backspace. Available in 5,6,7,8,10,12,14 inch widths. 5x4-3/4", 6x5-1/2" Chevy or 5x4-1/2" Ford lug patterns. -0 .....starting at **\$239.00 EA** ⚠

**Custom Wheel Nostalgia (Bare)**



**NB** ..... **ALL**  
Bare Steel Rim: 14, 15 or 16" Rims Specify size, width and backspace. Available in 5,6,7,8,10,12,14 inch widths. 5x4-3/4", 6x5-1/2" Chevy or 5x4-1/2" Ford lug patterns. -0 .....starting at **\$77.00 EA** ⚠

**Custom Wheel Nostalgia (Chrome)**



**NC** ..... **ALL**  
All Chrome Rim. 14, 15 or 16" Rims Specify size, width and backspace. Available in 5,6,7,8,10,12,14 inch widths. 5x4-3/4", 6x5-1/2" Chevy or 5x4-1/2" Ford lug patterns. -0 .....starting at **\$105.00 EA** ⚠

**Custom Wheel Nostalgia (Chrome Rim)**



**NCC** ..... **ALL**  
Chrome rim, bare steel center. 14, 15 or 16" Rims Specify size, width and backspace. Available in 5,6,7,8,10,12,14 inch widths. 5x4-3/4", 6x5-1/2" Chevy or 5x4-1/2" Ford lug patterns. -0 .....starting at **\$100.00 EA** ⚠

**Custom Wheel Rally (Bare)**



**RB** ..... **ALL**  
Rallye Bare Steel. 14, 15 or 16" Rims Specify size, width and backspace. Available in 5,6,7,8,10,12,14 inch widths. 5x4-3/4", 6x5-1/2" Chevy or 5x4-1/2" Ford lug patterns. -0 .....starting at **\$88.00 EA** ⚠

**Custom Wheel Rally (Chrome)**



**RC** ..... **ALL**  
All Chrome Rim: 14, 15 or 16" Rims Specify size, width and backspace. Available in 5,6,7,8,10,12,14 inch widths. 5x4-3/4", 6x5-1/2" Chevy or 5x4-1/2" Ford lug patterns. -0 .....starting at **\$116.00 EA** ⚠

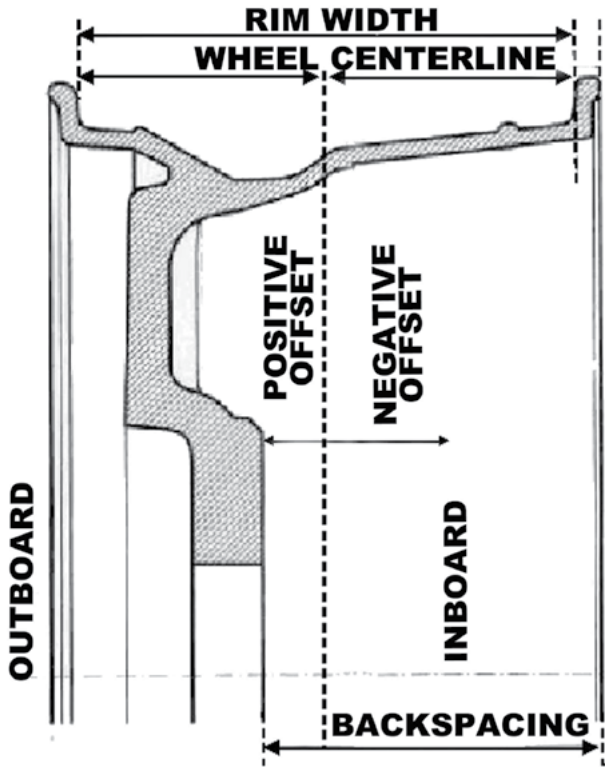

Returns require a return authorization number—call first. • Product pricing & availability subject to change.

**WARNING:** Cancer and Reproductive Harm — www.P65Warnings.ca.gov

**Custom Wheel Rally (Chrome Rim)**



**RCC**.....**ALL**  
 Chrome rim with bare steel center. 14, 15 or 16" Rims Specify size, width and backspace. Available in 5,6,7,8,10,12,14 inch widths. 5x4-3/4", 6x5-1/2" Chevy or 5x4-1/2" Ford lug patterns. -0 ... **CALL** ⚠

**Hub Caps Modified For Artillery / Nostalgia**



**594453M**.....**37-38**  
 Modified for artillery / nostalgia wheel 5.858 -0.15 ..... **\$120.00 EA** ⚠

**594453MS**.....**37-38**  
 Stainless. Modified for artillery / nostalgia wheel. 5.858 -0.2 ..... **\$85.00 EA** ⚠



**599748MS**.....**39**  
 Stainless. Modified to fit artillery / nostalgia wheel. 5.858 -0.2 ..... **\$82.00 EA** ⚠



**654307M**.....**40**  
 Chrome. Modified to fit artillery / nostalgia wheel. 5.858 -0 ..... **\$85.00 EA** ⚠

**3658374MS**.....**41-48**  
 Stainless 1941-48 Passenger (41-46 Commercial exc. 46 1Ton) For artillery / nostalgia wheels 5.858 -0.15 ..... **\$85.00 EA** ⚠

**Hub Caps Modified For Artillery / Nostalgia, cont.**



**3705092A** .....**47-53**  
 1/2Ton, modified to fit nostalgia wheel. Chrome 5.858 -0.15 ..... **\$84.75 EA** ⚠



**3908671** .....**ALL**  
 Police, plain. Fits artillery / nostalgia wheel. 5.858 -0.3 ..... **\$24.25 EA** ⚠

**MODIFY**.....**ALL**  
 Modify your hub cap to fit custom artillery / nostalgia or rally wheel 5.858 -0.15 ..... **\$60.00 EA** ⚠

**Hub Caps Modified For Rallye**



**594453MRS** .....**37-38**  
 Stainless. Modified for rallye wheel. 5.858 -0.15 ..... **\$92.00 EA** ⚠



**599748MR**.....**39**  
 Chrome. Modified to fit rallye wheel. 5.858 -0 ..... **CALL** ⚠



**599748MRS**.....**39**  
 Stainless. Modified to fit rallye wheel. 5.858 -0.15 ..... **\$85.00 EA** ⚠

**Hub Caps Modified For Rallye, cont.**

**654307MR**.....**40**  
 Chrome. Modified to fit rallye wheel. 5.858 -0.15 ..... **CALL** ⚠



**3658374MR**.....**41-48**  
 1941-48 Passenger (41-46 Commercial exc 46 1Ton) Modified to fit rallye wheel. 5.858 -0.15 ..... **\$75.50 EA** ⚠



**3705092AR**.....**47-53**  
 1/2Ton, modified to fit rallye wheel. 5.858 -0.15 ..... **\$85.00 EA** ⚠



**3908672** .....**ALL**  
 Police, plain. Fits rallye wheel. 5.858 -0.15 ..... **\$50.00 EA** ⚠



**3908673** .....**ALL**  
 Police w/ bowtie. Fits rallye wheel 5.858 -0.2 ..... **\$50.00 EA** ⚠

**MODIFY**.....**ALL**  
 Modify your hub cap to fit custom artillery / nostalgia or rally wheel 5.858 -0.15 ..... **\$60.00 EA** ⚠



**WARNING:** Cancer and Reproductive Harm — [www.P65Warnings.ca.gov](http://www.P65Warnings.ca.gov)

Chemicals shipped domestic ground only (Lower 48 states only). No international shipping.

**Phone: (360) 816-0211 • (800) 999-CHEV (2438) • [www.chevsofthe40s.com](http://www.chevsofthe40s.com)**

# Section 220T: Wheels, Hub Caps, Beauty Rims, Tires & Wheel Bearings

## Wheel Cover



**HCAPCADDY16** .....ALL  
16" Cadillac Sombbrero -0.15 .....  
**\$230.00 SET** ⚠



**HCAPSBURST14** .....ALL  
14 inch Starburst Style 5.858 -0.15 .....  
**\$105.25 SET** ⚠



**HCAPSBURST15** .....ALL  
15 inch Starburst Style 5.858 -0.15 .....  
**\$82.25 SET** ⚠



**HCAPSOMBRRER016** .....ALL  
Wheel Covers Bullet Sombbrero Style  
16"- Set of 4 -0.15 ..... **\$235.00 SET** ⚠

## Custom Hub Caps



**3705092N** .....ALL  
14 in. Nude Figure. Chrome. 5.858 -0.15  
..... **\$335.00 SET** ⚠

## Custom Hub Caps, cont.



**3705092Z** .....ALL  
15 in. nomad style. chrome -0 .....  
**\$105.00 EA** ⚠

**HCAPCROSS14** ..... ALL  
14 inch Crossbar style. 5.858 -0.15  
..... **\$300.00 SET** ⚠



**HCAPCROSS15** .....ALL  
15 inch Crossbar style. 5.858 -0 .. **CALL**  
⚠



**HCAPLANCER** .....ALL  
15 inch 59 Lancer style. 5.858 -0.15 .....  
**\$334.75 SET** ⚠



**HCAPLANCERB14** .....ALL  
14 inch 57 Lancer style. 5.858 -0.15 .....  
**\$249.00 SET** ⚠

**HCAPLANCERB15** ..... ALL  
15 inch 57 Lancer style. 5.858 -0.15  
..... **\$225.00 SET** ⚠



**HCAPPOLARA15** .....ALL  
15" Polara Style custom hub caps(set of  
4) 5.858 -0.15 ..... **\$272.50 SET** ⚠

## Nude Lady



5.858 -0.15 ..... **\$43.25 EA** ⚠

**3705092H** .....ALL  
3 dimensional nude  
figure handle or hubcap  
ornament. Chrome,  
12-1/4 in. length.

## SECTION 220T RESTORATION PARTS

### Stock GMC Hub Caps



**2019471** .....37-46  
GMC 1/2Ton & 37-41 GMC 3/4Ton.  
5.858 -0.15 ..... **\$54.75 EA** ⚠



**3705092P** .....47-53  
GMC chrome with white lettering. 1/2Ton  
only 5.858 -0.15 ..... **\$46.00 EA** ⚠



**2312395** .....47-55  
These hub caps are for 1946-53 3/4 ton  
and 1 Ton GMC Will Work on 1954-1955.  
Polished Stainless With Red Lettering 11"  
Dia -0 ..... **\$84.25 EA** ⚠



**3708058** .....55-59  
GMC 1/2Ton (superior) 5.858 -0  
..... **CALL**  
⚠



# Section 220T: Wheels, Hub Caps, Beauty Rims, Tires & Wheel Bearings

## Stock Hub Caps



**594453S** ..... **37-38**  
Stainless 5.858 -0.15 ..... **\$46.25 EA** ⚠



**3705092M** ..... **37-48**  
Baby moon, 37-48 Cars. 37-46 1/2Ton &  
37-41 3/4Ton. 5.858 -0.15 ..... **\$178.25 SET**  
⚠

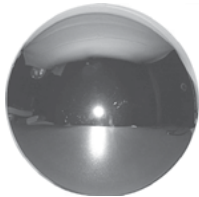

**3705092MM** ..... **37-59**  
Baby moon, 37-46 1/2Ton & 37-41  
3/4Ton, modified to fit nostalgia wheel  
5.858 -0.15 ..... **\$40.00 EA** ⚠



**599748S** ..... **39**  
Stainless 5.858 -0.15 ..... **\$60.25 EA** ⚠



**654307** ..... **40**  
Chrome 5.858 -0 ..... **CALL** ⚠  
**654307S** ..... **40**  
Stainless 5.858 -0.15 ..... **\$51.75 EA** ⚠

**3658374S** ..... **41-48**  
Stainless 1941-48 Passenger (41-46  
Commercial exc. 46 1Ton) 5.858 -0.15 ..  
**\$56.50 EA** ⚠

## Stock Hub Caps, cont.



**3680919** ..... **47-53**  
Chrome with red (3/4Ton, 1Ton) 5.858 -0.15  
..... **\$63.50 EA** ⚠

**3705092** ..... **47-53**  
1/2Ton. Chrome w/ red letters. 5.858 -0  
..... **\$41.00 EA** ⚠



**3705092G** ..... **47-53**  
GMC chrome with red lettering. 1/2Ton  
only 5.858 -0.15 ..... **\$57.75 EA** ⚠



**3705092S** ..... **47-53**  
1/2Ton. Stainless steel. 5.858 -0.15 .....  
**\$68.50 EA** ⚠

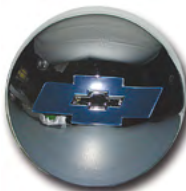

**3708057** ..... **54**  
1/2 Ton 5.858 -0.15 ..... **\$47.00 EA** ⚠  
**3708057C** ..... **54**  
1/2 Ton Stainless 5.858 -0.15  
..... **\$45.00 EA** ⚠

## Hub Cap Retaining Clip



**3704844** ..... **39-53**  
Retaining clip. Fits  
39-53 Pass (w/ 15in  
wheels) & 39-58 1/2T  
truck (w/ 16in wheels). 5.864 -0.15  
..... **\$2.50 EA** ⚠

## Decal Hub Cap



**3705092K** ..... **47-53**  
Black (set of 4) 5.858 -0.15 ..... **\$21.00 SET**  
⚠



**3705092R** ..... **47-53**  
Red (set of 4) 5.858 -0 ..... **\$23.75 SET** ⚠

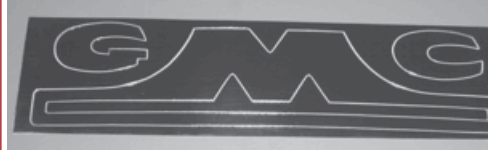

**3705092GK** ..... **47-55**  
GMC decal. Black (set of 4) 5.858 -0.15  
**\$14.50 SET** ⚠



**3705092GR** ..... **47-55**  
GMC decal. Red (set of 4) 5.858 -0.15  
**\$15.50 EA** ⚠



**3705092GW** ..... **47-55**  
GMC decal. White (set of 4) 5.858 -0.15  
**\$14.50 SET** ⚠

## Beauty Rings



**1279680** ..... **ALL**  
Ribbed 16 in. (outer wheel). 5.858 -0.15  
..... **\$33.50 EA** ⚠  
**1279680S** ..... **ALL**  
Smooth 16 in. (outer wheel). 5.858 -0.15  
..... **\$26.75 EA** ⚠

**986259** ..... **ALL**  
Ribbed 15 in. (outer wheel). 5.858 -0.15  
..... **\$29.75 EA** ⚠

**986259S** ..... **ALL**  
Smooth 15 in. (outer wheel). 5.858 -0.15  
..... **\$25.00 EA** ⚠



**WARNING:** Cancer and  
Reproductive Harm —  
www.P65Warnings.ca.gov

Chemicals shipped domestic ground only (Lower 48 states only). No international shipping.

Phone: (360) 816-0211 • (800) 999-CHEV (2438) • www.chevsofthe40s.com

**Tires**

Oversize shipping charges apply. Please call for rate.

**Tire With White Wall, Radial**

Note: All tires must be inflated to manufacturers recommended PSI.



**368981R** .....ALL  
(670x15) Coker classic. 2-3/8 in. white wall 5.804 -0 ..... **\$242.50 EA** ⚠

**3693215R** .....ALL  
(650x16) Diamond Back Classics 3-1/2 in. white wall. Tubeless. 5.804 -0 ..... **\$325.00 EA** ⚠



**3693215RC** ...ALL  
(650x16) Coker Classic 3-1/4 in. white wall. 5.804 -0 ..... **\$340.75 EA** ⚠

**Tire With Black Wall, Radial**



**599887R** .....ALL  
(600x16) Coker, BF Goodrich. Made from original molds. 5.804 -0.15 .. **\$330.00 EA** ⚠

**Tire With White Wall, Bias Ply**

**368981** .....ALL  
(670x15) Coker, BF Goodrich 3-5/8 in. white wall tubeless 5.804 -0 ..... **\$255.00 EA** ⚠

**3693215** .....ALL  
(650x16) Coker, BF Goodrich 3-3/4 in. white wall 5.804 -0 ..... **\$245.75 EA** ⚠

**3693215F** .....ALL  
(650x16) Coker, Firestone 3-1/4 in. white wall. 5.804 -0 ..... **\$245.00 EA** ⚠

**Tire With White Wall, Bias Ply, cont.**



**599886** .....ALL  
(600x16) BF Goodrich 3-1/2 in. white wall. Made from original molds. 5.804 -0 ..... **\$259.75 EA** ⚠

**Tire With Black Wall, Bias Ply**

**368981B** .....ALL  
(670x15) Coker, BF Goodrich. Tubeless. 5.804 -0 ..... **\$202.00 EA** ⚠

**3693215B** .....ALL  
(650x16) Coker, BF Goodrich. 5.804 -0 ..... **\$211.50 EA** ⚠



**599887** .....ALL  
(600x16) BF Goodrich. 4 ply. Made from original moulds. 5.804 -0 ..... **\$197.75 EA** ⚠

**Tire Care**



**91800** .....ALL  
Wide White has been developed specifically to aid in restoring and beautifying wide whitewall tires. This cleaner is safe to use on white rubber and is made from

environmentally friendly ingredients. Restore your sidewalls to snowy white luster. -0 ..... **\$11.00 EA** ⚠



**WHITEWIPE** ...ALL  
Bleach free white wall tire wipes. 7" x 9" wipe. 35 per container. -0 ..... **CALL** ⚠

**Tube**



**599885** .....ALL  
600-650 x 16 5.804 -0 ..... **\$27.50 EA** ⚠

**Valve Stem Cap**



**599884** .....ALL  
Original metal style (5 pcs) 5.804 -0.4 ... **\$5.00 SET** ⚠



**CROWNCAPGD** .....ALL  
Crown cap. Gold plastic (5 pcs). 5.804 -0 ..... **\$9.50 SET** ⚠



**CROWNCAPR** .....ALL  
Crown cap. Red plastic (5 pcs). 5.804 -0.15 ..... **\$6.25 SET** ⚠



**VC69978** .....ALL  
Chrome Large 8 Ball Valve Cap -0.2 ..... **\$10.25 SET** ⚠



**VC69981** .....ALL  
Chrome Dice Valve Caps -0 ..... **CALL** ⚠



**VC70004** .....ALL  
Skull Valve Caps -0.15 ..... **\$7.25 SET** ⚠



**VC70005** .....ALL  
Dice Valve Caps-Red With White Dots -0.15 ..... **\$4.25 SET** ⚠



**VC70006** .....ALL  
Dice Valve Caps-White With Black Dots -0.15 ..... **\$4.00 SET** ⚠



**VC70007** .....ALL  
Dice Valve Caps-Black With White Dots -0.15 ..... **\$4.00 SET** ⚠



**VC70008** .....ALL  
Dice Valve Caps- Blue With White Dots -0.15 ..... **\$4.00 SET** ⚠



**Valve Stem Cap, cont.**



**VC70022.....ALL**  
8 Ball Valve Caps -0.15  
..... **\$4.00 SET** ⚠️



**VC70038.....ALL**  
Chrome Spike Valve  
Caps -0.15  
..... **\$8.25 SET** ⚠️

**Tinnerman Nuts**



**365897.....ALL**  
Retains rear brake  
drum (6 pcs). 5.810-0.2  
..... **\$7.50 SET** ⚠️

**Lug Nut**



**358501.....29-57**  
Pass Car, 1/2Ton &  
29-42 3/4Ton & 1Ton  
5.813-0.4  
..... **\$1.25 EA** ⚠️

**Stud For Lug Nut**



**370465.....36-50**  
Front 1/2Ton & 36-42  
3/4Ton, 1Ton 5.812-0.2  
..... **\$3.75 EA** ⚠️



**375696.....36-57**  
Rear 1/2Ton & 36-42  
3/4Ton, 1Ton 5.812-0.2  
..... **\$3.75 EA** ⚠️



**476515.....51-57**  
Front 1/2Ton 5.812-0.4  
..... **\$2.25 EA** ⚠️

**Spindle Nut & Washer**



**379656.....35-57**  
1-1/2Ton & 2Ton, 46-  
57 3/4Ton 6.022-0  
..... **CALL** ⚠️



**378137.....40-54**  
1/2Ton & 40-42  
3/4Ton, 1Ton 6.022-0.15  
..... **\$4.00 SET** ⚠️

**Dust Cover**



**370262.....36-54**  
Front wheel bearing dust cover. Fits  
1/2Ton & 36-42 3/4Ton & 1Ton 5.858-0.2  
..... **\$13.00 PR** ⚠️

**Front Wheel Bearing Seal**



**352488.....29-40**  
Cars & 1/2Ton trucks.  
6.326-0.3  
..... **\$24.00 EA** ⚠️



**379654.....35-57**  
1-1/2Ton, 46-57  
3/4Ton & 1Ton exc. 42  
Bus, 51-52 1-1/2Ton &  
Heavy Duty 6.326-0.15  
..... **\$24.75 EA** ⚠️



**3656536.....41-57**  
1/2Ton, 41-42 3/4Ton  
& 1Ton 6.326-0.2  
..... **\$14.00 EA** ⚠️

**Front Inner Wheel Bearing**



**909002.....29-40**  
Inner. Front wheel. Fits Pass, 1/2Ton &  
3/4Ton 6.311-0.2 ..... **\$105.00 EA** ⚠️

**909026.....35-52**  
35-42 utility, 46-50 3/4Ton, 1Ton,  
1-1/2Ton; 51-52 3/4Ton & 1Ton  
6.311-0.15 ..... **\$37.00 EA** ⚠️

**909052.....41-57**  
Inner. Fits 41-42, 1/2Ton, 3/4Ton, 1Ton  
6.311-0.2 ..... **\$85.00 EA** ⚠️

**173241.....46-49**  
Utility, 2T, school bus chassis 6.317-0.15  
..... **\$136.00 EA** ⚠️

**909046.....53-57**  
3/4Ton, 1Ton, 1-1/2Ton 6.311-0.15  
..... **\$150.00 EA** ⚠️

**Front Inner Wheel Bearing, Roller**



**909002R.....29-40**  
ROLLER replacement. Inner, front. PASS &  
1/2Ton & 3/4Ton. 6.311-0 ..... **CALL** ⚠️

**909026R.....35-52**  
Roller replacement 35-42 utility, 46-50  
3/4Ton, 1Ton, 1-1/2Ton; 51-52 3/4Ton &  
1Ton 6.311-0.15 ..... **\$167.50 EA** ⚠️

**909052R.....41-57**  
Inner. Roller replacement. Fits 1/2Ton,  
41-42 3/4Ton, 1Ton 6.311-0.4  
..... **\$72.75 EA** ⚠️

**Front Inner Wheel Bearing, Roller, cont.**

**909046R.....53-57**  
Roller for 3/4Ton, 1Ton & 1-1/2Ton (not  
original). 6.311-0 ..... **\$99.00 EA** ⚠️

**Front Outer Wheel Bearing**



**909001.....29-57**  
Fits Pass and 1/2Ton & 29-42 3/4Ton  
(Exc. 33-36 Standard CC-DC-EC-FC)  
6.313-0.2 ..... **\$35.00 EA** ⚠️

**909025.....35-52**  
35-42 1-1/2Ton, 2Ton; 46-50 3/4Ton,  
1Ton, 1-1/2Ton; 51-52 3/4Ton & 1Ton  
6.313-0.15 ..... **\$38.00 EA** ⚠️

**173238.....46-49**  
2Ton & Bus with 15/16 in. diameter hole  
(49 early) 6.313-0.15 .. **\$125.25 EA** ⚠️

**188932.....46-57**  
3/4Ton, 1Ton rear 5.855-0 ..... **CALL** ⚠️

**909045.....53-57**  
3/4Ton, 1Ton, 1-1/2Ton 6.313-0.15  
..... **\$129.75 EA** ⚠️

**Front Outer Wheel Bearing, Roller**



**909001R.....29-57**  
ROLLER replacement. Outer. Fits Pass &  
1/2Ton & 29-42 3/4Ton 6.313-0.15  
..... **\$50.00 EA** ⚠️

**909025R.....35-52**  
Roller replacement. Outer. (35-42  
1-1/2Ton, 2Ton; 46-50 3/4Ton, 1Ton,  
1-1/2Ton; 51-52 3/4Ton & 1Ton)  
6.313-0.15 ..... **\$71.75 EA** ⚠️

**909045R.....53-57**  
Roller replacement. Outer. For 3/4Ton,  
1Ton & 1-1/2Ton (not original). 6.313-0.15  
..... **\$125.00 EA** ⚠️

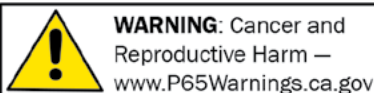

**WARNING:** Cancer and  
Reproductive Harm —  
www.P65Warnings.ca.gov

Chemicals shipped domestic ground only (Lower 48 states only). No international shipping.

**Phone: (360) 816-0211 • (800) 999-CHEV (2438) • www.chevsofthe40s.com**

**Front Wheel Bearing Roller Conversion**



**BEARINGKIT.....41-57**

Convert your ball bearings to roller. For both sides of front end. 1/2 ton only.

6.311 -0.2 ..... **\$268.00 SET** ⚠

**Odds & Ends**

Please call for availability on all Odds & Ends parts; once part is sold, it may no longer be in stock.

**370957.....29-38**

Oil Deflector, Front Hub, Straight

14.000 -0.4 ..... **\$6.00 EA** ⚠

**3689081N.....40-47**

Rear Wheel Hub Conversion Kit (Utility)

13000.000 -0.4 ..... **\$25.00 EA** ⚠

**985705.....41-42**

Wheel discs w/o ribs. Needs rechromed

16.000 -0.4 ..... **\$150.00 EA** ⚠

**909602U.....46-57**

Inner bearing cup, NOS fits 1/2Ton

6.316 -0.4 ..... **\$30.00 EA** ⚠

**986108N.....47-48**

Accy. Tire Tracks to get out of snow and sand. -0.4

..... **\$100.00 SET** ⚠

**12380..... 48**

Accy. Wheel Covers, 16in. (Used)

16.000 -0.4 ..... **\$65.00 EA** ⚠

**986358U.....49-50**

Accy. Wheel Cover (Used) 16.000 -0.4

..... **\$65.00 EA** ⚠

**909066.....60-61**

Front wheel bearing-inner, fits 1/2Ton

6.311 -0.4 ..... **\$25.00 EA** ⚠



**COE — Orrantia G. Sergio**

Returns require a return authorization number—call first. • Product pricing & availability subject to change.

**144 Phone: (360) 816-0211 • (800) 999-CHEV (2438) • www.chevsofthe40s.com**

 **WARNING:** Cancer and Reproductive Harm — [www.P65Warnings.ca.gov](http://www.P65Warnings.ca.gov)

# Section 230T: Bumpers, Bumper Brackets, Splash Aprons, License Brackets, & License Frames

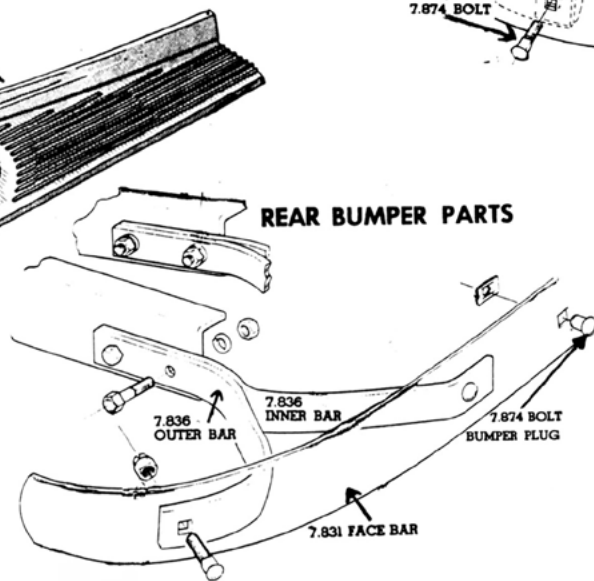
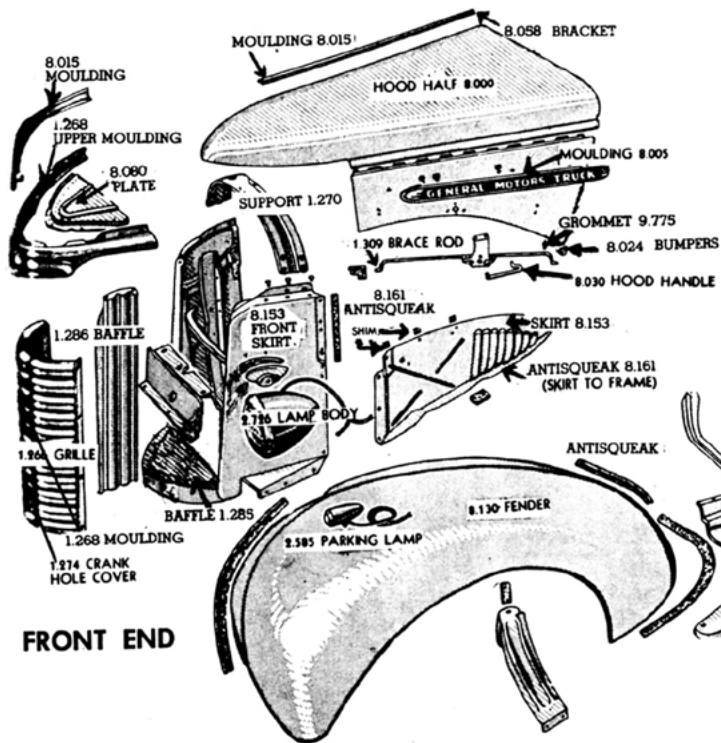
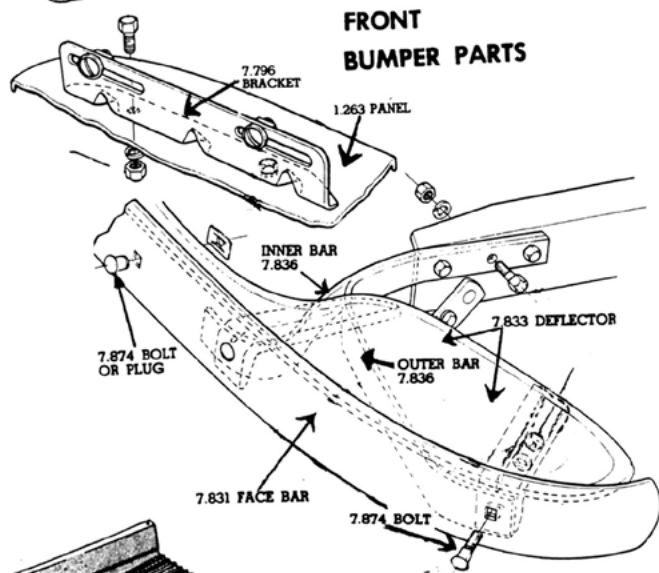
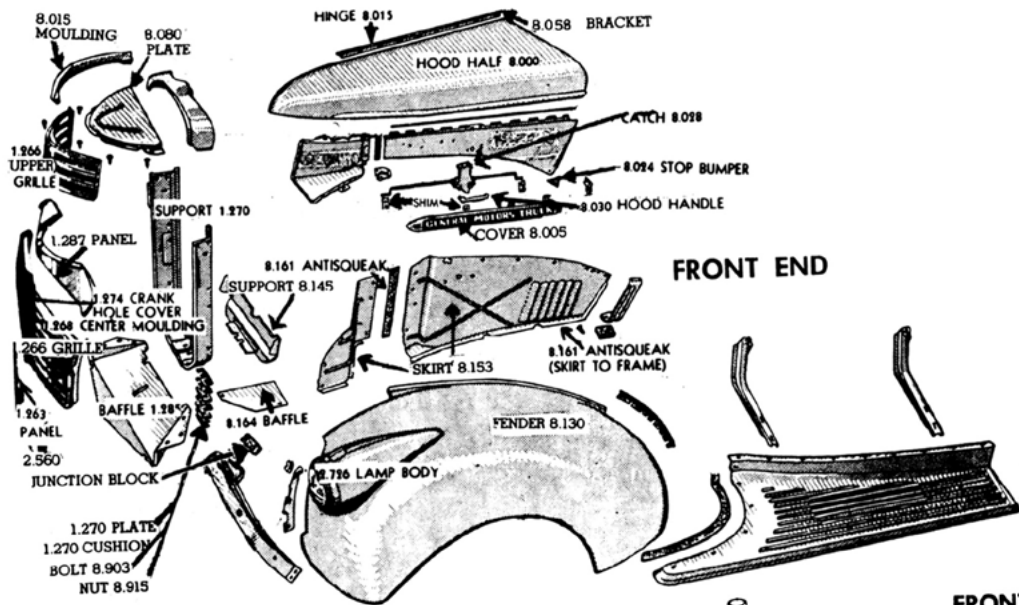

**WARNING:** Cancer and Reproductive Harm — [www.P65Warnings.ca.gov](http://www.P65Warnings.ca.gov)

Chemicals shipped domestic ground only (Lower 48 states only). No international shipping.

Phone: (360) 816-0211 • (800) 999-CHEV (2438) • [www.chevsofthe40s.com](http://www.chevsofthe40s.com)

**SECTION 230T  
STREET ROD PARTS**

**Briz Bumpers**



**BRIZ5RIB.....35-54**  
Original 5 rib, fully polished (front and rear) alloy bumper. Fits 35-48 Chevy cars, 37+54 Chevy trucks. 4-1/2 in. face. Mount Front or Rear. 7.831 -0.15 .....  
**\$331.25 EA** ⚠️



**BRIZ5RIB-C.....47-54**  
5 rib polished alloy contoured bumper. Contoured to match the front of your truck. Fits 47-54 Chevy trucks. 4-1/2 in. face (does not include brackets or bolts). -0.15 .....  
**\$472.75 EA** ⚠️



**BRIZ5RIB-SH.....ALL**  
Original 5 rib polished alloy bumper. Fits 49-53 Chevy cars, 41-54 Chevy trucks. 4-1/2 in. face. 7.831 -0.15 .....  
**\$320.00 EA** ⚠️



**BRIZBOLT.....ALL**  
Polished, Stainless bumper bolt. Radiused head to fit over ribs. -0.15 .....  
**\$11.50 EA** ⚠️

**Bumper Brackets, Alloy**



**BRACKETYF-C.....47-54**  
UN-Polished, "Y" style for 5 rib contoured front bumper, 47-54 Chevy Trucks. -0.15 .....  
**\$198.75 L&R** ⚠️



**BRACKETYFP-C.....47-54**  
Polished, "Y" style for 5 rib contoured front bumper, 47-54 Chevy Trucks. -0.15 .....  
**\$275.75 L&R** ⚠️



**BRACKETJFP.....ALL**  
Polished, "J" style front. Call for your specific application. Fits BRIZ & other bumpers for most 37-54 Chevy trucks, 28-32 (some 33-36 & 46-57) Ford cars & most 28-56 Ford trucks. -0.15 .....  
**\$214.09 L&R** ⚠️



**BRACKETYFP.....ALL**  
Polished, "Y" style front. Call for your specific application. Fits BRIZ & other bumpers for 37-48 (some 35-36) Chevy cars, some 37-54 Chevy trucks, 37-41 (some 33-36) Ford cars & some 33-41 Ford trucks. -0.15 ...  
**\$275.75 L&R** ⚠️

**Bumper Brackets, Alloy, cont.**



**BRACKETYRP.....ALL**  
Polished, "Y" style rear. Call for your specific application. Fits BRIZ & other bumpers for 37-48 Chevy cars, some 37-54 Chevy trucks, 37-41 Ford cars & some 33-41 Ford trucks. -0.15 .....  
**\$275.75 L&R** ⚠️



**BRIZBRKT.....ALL**  
License plate mounting bracket for BRIZ license guard. -0.15 ...  
**\$29.50 EA** ⚠️

**Briz Bumper License Guard/Bracket**



**BRIZBGUARD.....ALL**  
Polished. '49 Chevy style. -0.15 .....  
**\$194.25 EA** ⚠️

**Rear Roll Pans**

Oversized shipping charges apply. Please call for rate.



**3658265P.....41-46**  
Steel pan. Rear with license plate recess. Replaces back bumper for smooth look. 7.831 -0.15 .....  
**\$167.25 EA** ⚠️



**3683305P.....47-53**  
Steel pan. Rear with license plate recess. Replaces back bumper for smooth look. 7.831 -0.15 .....  
**\$167.25 EA** ⚠️

**Rear Roll Pans, cont.**



**3683305PS** .....47-53  
Steel pan. Replaces back bumper for smooth look. 7.831 -0.15 **\$115.25 EA** ⚠️



**3705437P** .....54-87  
Steel pan. Rear with license plate recess. Replaces back bumper for smooth look. Fits stepside only 7.831 -0.15 .....  
**\$167.25 EA** ⚠️

**SECTION 230T RESTORATION PARTS**

**Bumpers**

Oversized shipping charges apply. Please call for rate.  
Oversized shipping charges apply to. Please call for rate.



**594648** ..... 37  
Copper-Nickel-Chrome. Fits on Master front & Front or Rear on trucks. 7.831 -0 .....  
**\$430.50 EA** ⚠️



**594648S** ..... 37  
Polished Stainless. Fits on Master front & Front or Rear on trucks. 7.831 -0.15  
**\$498.75 EA** ⚠️



**3847305** .....38-39  
Copper-Nickel-Chrome. Front or Rear. 7.831 -0 .....  
**\$430.50 EA** ⚠️

**Bumpers, cont.**



**3847305S** .....38-39  
Polished Stainless. Front or Rear. No holes. Studs for brackets welded to back. 7.831 -0.15 .....  
**\$498.75 EA** ⚠️



**3653339** ..... 40  
Copper-Nickel-Chrome. Fits front or rear (exc. rear of Wagon & Sedan Delivery). 7.831 -0 .....  
**\$430.50 EA** ⚠️



**3653339S** ..... 40  
Polished Stainless. No holes. Studs for brackets welded to back. Fits front or rear (exc. rear of Wagon & Sedan Delivery). 16.400 -0.15 .....  
**\$498.75 EA** ⚠️



**3658265** .....41-46  
Nickel-Chrome. Front. Exc 41-42 COE & 46 1-1/2T w/ 160in. wheelbase. 7.831 -0.15 .....  
**\$430.00 EA** ⚠️



**3658265A** .....41-46  
Nickel-Chrome. Rear. 1/2Ton & 3/4Ton (original panels & Suburbans w/ doors had 1-1/2 in. less arc). 7.831 -0.15 .....  
**\$430.00 EA** ⚠️



**3658265S** .....41-46  
Polished stainless. Front with bolt holes (exc 41-42 COE & 46 1-1/2Ton w/ 160 in. wheelbase). 7.831 -0.15 .....  
**\$499.00 EA** ⚠️

**Bumpers, cont.**



**3658265SA** .....41-46  
Polished stainless. Rear with bolt holes. Fits 1/2Ton & 3/4Ton Truck (panels & Suburbans w/ doors had 1-1/2 in. less arc). 7.831 -0.15 .....  
**\$499.00 EA** ⚠️



**3683350** .....47-53  
Nickel-Chrome. Rear. Exc panel & Suburban. 7.831 -0.15 .....  
**\$185.00 EA** ⚠️



**3683350S** .....47-53  
Polished stainless. Rear, exc. Panel & Suburban. Nice!. Chevy & GMC 7.831 -0.15 .....  
**\$525.00 EA** ⚠️



**3700438** .....47-54  
Nickel-Chrome. Front. Also fits rear of panel and Suburban. 7.831 -0.15 .....  
**\$185.50 EA** ⚠️



**3700438P** .....47-54  
PAINTED. Front. Also rear of panel and Suburban. 7.831 -0.15 .....  
**\$156.00 EA** ⚠️



**3700438S** .....47-54  
Polished stainless Front, also fits rear of Panel & Suburban. Chevy & GMC 7.831 -0.15 .....  
**\$498.75 EA** ⚠️



**3705437** ..... 54  
Nickel-Chrome 7.831 -0.15 .....  
**\$196.00 EA** ⚠️

**WARNING:** Cancer and Reproductive Harm — www.P65Warnings.ca.gov

**Bumper Guard**



**597827**.....**38-39**  
Front or rear bumper. Fits left or right.  
7.828 -0.15 ..... **\$159.25 EA** ⚠️



**986113**.....**47-54**  
Front or rear (accessory). 7.828 -0.15 ..  
**\$89.75 L&R** ⚠️



**986113R**.....**47-54**  
Front or rear (accessory). Rubber face.  
Includes mounting hardware. 7.828 -0.15  
..... **\$25.00 EA** ⚠️

**Bumper Bolt**



**594206**.....**37-46**  
Oval head bolt, nut & lock washers, as original. 7.874 -0  
..... **\$8.00 EA** ⚠️



**3695906**.....**47-54**  
Standard bolt, marsden nut, flat & lock washers, as original.  
7.874 -0  
..... **CALL** ⚠️



**3695907**.....**47-54**  
Stainless w/ standard bolt, nut, flat & lock washers, as original.  
7.874 -0  
..... **CALL** ⚠️



**3695907C**.....**47-54**  
Chrome w/ standard nut & washers.  
7.874 -0.15  
..... **\$2.75 EA** ⚠️

**Bumper Guard Bolt**



**597825A**..... **37**  
1-1/8in. x 2-1/2in. With nut and lock washer  
7.829 -0.15  
..... **\$35.00 EA** ⚠️



**597825**.....**38-39**  
1-3/8in. x 2-1/2in.  
7.829 -0.15  
..... **\$13.00 EA** ⚠️

**Bumper Bracket**

Note: Bumper brackets are supplied in raw steel. Preparation will be required before paint.



**594154**..... **37**  
Rear 7.836 -0.15 ..... **\$176.00 L&R** ⚠️



**594711**..... **37**  
Front 7.836 -0.2 ..... **\$169.75 L&R** ⚠️



**350590**.....**38-39**  
Front 7.836 -0.2 ..... **\$164.75 L&R** ⚠️



**597872**.....**38-39**  
Rear 7.836 -0.15 ..... **\$180.50 L&R** ⚠️



**3653681**..... **40**  
Front 7.836 -0.15 ..... **\$159.00 L&R** ⚠️

**Bumper Bracket, cont.**



**3653862**..... **40**  
1/2 Ton Rear 7.836 -0.15 ..... **\$179.25 L&R** ⚠️



**3658053**.....**41-46**  
Front, 1/2 & 3/4 Ton 7.836 -0 .....  
**\$155.00 L&R** ⚠️



**599382B**.....**41-46**  
Rear. 6 piece set. Fits 1/2 ton & 3/4 ton.  
7.836 -0.1 ..... **\$125.50 L&R** ⚠️



**3684827B**.....**47-54**  
Rear (1/2T). Chevy & GMC 7.836 -0.15  
**\$88.50 L&R** ⚠️



**3684833**.....**47-54**  
Rear (3/4 & 1T). 7.836 -0.15 .....  
**\$198.75 L&R** ⚠️



**3701949**.....**47-54**  
Front (1/2T & 3/4T). Chevy & GMC  
7.836 -0.15 ..... **\$116.75 L&R** ⚠️

Returns require a return authorization number—call first. • Product pricing & availability subject to change.

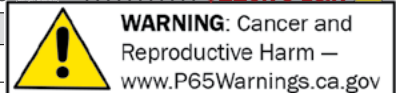

**Bumper Grommets**



**599743** ..... **39-46**  
Rear bumper panel,  
Suburban (2 pcs).  
7.792 -0.15  
..... **\$33.00 PR** ⚠



**3658003** ..... **41-46**  
Front bumper. 7.792 -0.15  
..... **\$18.25 PR** ⚠

**Front Splash Apron**

Oversized shipping charges apply. Please call for rate.



**3684145** ..... **47-53**  
Bumper to grille. Steel (does not fit GMC) superior quality. 1.287 -0.15  
..... **\$88.75 EA** ⚠



**3684145C** ..... **47-53**  
Bumper to grille. Chrome (does not fit GMC). 1.287 -0.15  
..... **\$159.75 EA** ⚠



**3684145G** ..... **49-53**  
Bumper to grille. Steel, GMC. 1.287 -0  
**CALL** ⚠

**3701226** ..... **54**  
Bumper to grille. Steel (does not fit GMC). 1.287 -0.15  
..... **\$85.00 EA** ⚠

**3701226C** ..... **54**  
Bumper to grille. Chrome (does not fit GMC). 1.287 -0.15  
..... **\$159.00 EA** ⚠

**Rear Splash Apron**



**3690258A** ..... **47-53**  
Fits over bumper brackets. (Exc. Panel & Suburban) Original for 1/2 ton. Modification needed for 3/4 ton due to different bumper brackets. 7.833 -0.15  
..... **\$150.00 EA** ⚠

**Bumper Seal**



**3690257** ..... **47-54**  
Body to rear bumper panel or Suburban. 7.833 -0.15  
..... **\$21.00 EA** ⚠

**License Accessories**



**985096** ..... **37-64**  
Chome Diamond, choose diamond color: clear, amber, red, green, blue, purple. 9.777 -0.15  
..... **\$14.00 EA** ⚠



**10887** ..... **ALL**  
Chrome bullet wing nut license fastener. Set of 4 -0.15  
..... **\$5.25 SET** ⚠



**985094** ..... **ALL**  
Glass jewel reflector. Specify Red, Green, Blue, Amber, Burnt Orange, Purple, Clear, Light Blue, Yellow, Rainbow. (2 pcs). 9.777 -0.2  
..... starting at **\$20.00 PR** ⚠



**985094P** ..... **ALL**  
Plastic jewel reflector. Red (2 pcs). 9.777 -0.15  
..... **\$3.00 PR** ⚠



**FLAG01** ..... **ALL**  
License Plate Frame Accessory, U.S.A. Flag -0.4  
..... **\$1.75 EA** ⚠

**License Accessories, cont.**



**FLAG02** ..... **ALL**  
Flag Holder - 5 Post -0.15  
..... **\$10.75 EA** ⚠



**FLAG03** ..... **ALL**  
Flag Holder-Chrome 3 Post -0.15  
..... **\$9.50 EA** ⚠

**License Plate Toppers**



**FELIX** ..... **ALL**  
Universal Felix the cat license frame ornament. -0.15  
..... **\$20.75 EA** ⚠



**PLATETOP48** ..... **ALL**  
48 Star Flag -0  
..... **\$16.99 EA** ⚠



**PLATETOPCAT** ..... **ALL**  
Cat with moving eyes and tongue. -0  
..... **\$19.50 EA** ⚠

**VPALPT007AB** ..... **ALL**  
Chrome Safety Star With Amber Led Illumination -0.15  
..... **\$44.00 EA** ⚠

**VPALPT007GN** ..... **ALL**  
Chrome Safety Star With Green Led Illumination -0  
..... **CALL** ⚠

**VPALPT007RD** ..... **ALL**  
Chrome Safety Star With Red Led Illumination -0.15  
..... **\$44.00 EA** ⚠



**VPALPT008** ..... **ALL**  
Pegasus (Drive Safely) -0.15  
..... **\$17.00 EA** ⚠



**WARNING:** Cancer and Reproductive Harm — www.P65Warnings.ca.gov

Chemicals shipped domestic ground only (Lower 48 states only). No international shipping.

**Phone: (360) 816-0211 • (800) 999-CHEV (2438) • www.chevsofthe40s.com**

**License Plate Frame**



**986710.....37-54**  
 Year on top and "Chevrolet" on bottom of frame. Choose 1937-1954 (Exc 43-45). Specify year when ordering. (2 pcs).  
 - Made For Modern Plates 9.777 -0 starting at **\$18.50 SET** ⚠️



**986708.....ALL**  
 Telescoping (8 pcs), 2 ribs on end of each piece. Polished stainless. Original accessory 48-55. 9.777 -0.15 .....  
**\$50.75 EA** ⚠️

**License Plate Bracket**

Note: Rear License Plate Bracket see Tail Light Bracket Section 110T.



**595805.....37-40**  
 Front 7.796 -0.15 ..... **\$37.50 EA** ⚠️



**605358.....41-46**  
 Front 7.796 -0.15 ..... **\$30.75 EA** ⚠️



**3847439.....47-53**  
 Front 7.796 -0.15 ..... **\$10.00 EA** ⚠️



**3847439C.....47-53**  
 Front (chrome). 7.796 -0.2 ..... **\$23.00 EA** ⚠️



**3847440A.....54**  
 Front 7.796 -0.15 ..... **\$12.50 EA** ⚠️



**3707021.....54-59**  
 Pickup (w/ rear bumper) exc Suburban & Panel. Includes license light rear.  
 2.705 -0.15 ..... **\$32.00 EA** ⚠️

**Odds & Ends**

Please call for availability on all Odds & Ends parts; once part is sold, it may no longer be in stock.

**3656466.....41-46**  
 Bumper Bracket Front Outer NOS  
 17000.000 -0.4

..... **\$20.00 EA** ⚠️  
**3683665.....47-55**  
 Bumper Bracket Front & Rear Outer Left  
 17000.000 -0.4

..... **\$20.00 EA** ⚠️



**SECTION 240T  
RESTORATION PARTS**

Note: Oversize shipping charges apply on all grilles. Please call for rates.

**1937 Grille With Billet Aluminum Bars**

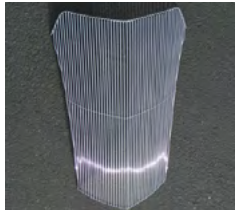

**595112BNF ... 37**  
Polished (front bars only). Narrow bar spacing (1/4in. space). 1.266-0  
..... **\$1,075.00 EA** ⚠

**595112BNP..... 37**  
Fully polished. Narrow bar spacing (1/4in. space). 1.266-0  
..... **\$1,295.00 EA** ⚠

**595112BWF ..... 37**  
Polished (front of bars only). Standard bar spacing (3/8in. space). 1.266-0  
..... **\$850.00 EA** ⚠



**595112BWP ... 37**  
Fully polished. Standard bar spacing (3/8in. space). 1.266-0  
..... **\$1,025.00 EA** ⚠

**1937 "Gangster Grille"**



**595112LP ..... 37**  
Laser cut. Bare steel for street rod. 1.266-0.15  
..... **\$471.75 EA** ⚠



**595112LS ..... 37**  
Laser cut. Polished stainless for street rod. 1.266-0.15  
..... **\$835.00 EA** ⚠

**1937 Grille**

**595112..... 37**  
Bare steel as original. 1.266-0.15  
..... **CALL** ⚠

**1937 Grille, cont.**



**595112S ..... 37**  
Stainless, like original. 1.266-0.15  
..... **\$904.00 EA** ⚠

**1937 Grille Moulding**



**594721 ..... 37**  
Side moulding. Cut to length. 1.268-0  
**\$180.00 L&R** ⚠



**595311..... 37**  
Upper moulding. Polished stainless. 1.268-0.15  
..... **\$250.25 EA** ⚠



**595539 ..... 37**  
Clips 4 piece set. (2 sets required) 1.269-0.15  
..... **\$14.00 SET** ⚠

**1937 Grille Center Strip**



**594996 ..... 37**  
As original. 1.268-0.15  
..... **\$93.75 EA** ⚠

**594996S ..... 37**  
Street rod (no holes for emblem or crank). 1.268-0.15  
..... **\$143.00 EA** ⚠

**1937 Crank Hole Cover**



**595039 ..... 37**  
This is a crank hole cover. 1.274-0  
..... **\$48.50 EA** ⚠

**1937 Grille Emblem**



**595376..... 37**  
Chrome. 1.303-0  
..... **\$90.00 EA** ⚠



**595376P..... 37**  
Chrome with painted details. 1.303-0  
**CALL** ⚠

**1937 Grille Shell**



**602395 ..... 37**  
Fiberglass. 1.263-0  
..... **CALL** ⚠

**1938 "Gangster Grille"**



**597829LP..... 38**  
Laser cut. Bare steel for street rod. 1.266-0.15  
..... **\$440.00 EA** ⚠



**597829LS ..... 38**  
Laser cut. Polished stainless for street rod. 1.266-0.15  
..... **\$850.00 EA** ⚠



**WARNING: Cancer and Reproductive Harm —**  
www.P65Warnings.ca.gov

Chemicals shipped domestic ground only (Lower 48 states only). No international shipping.

**Phone: (360) 816-0211 • (800) 999-CHEV (2438) • www.chevsofthe40s.com**

**1938 Grille**



**597829 ..... 38**  
Bare steel as original. 1.266-0  
..... **CALL** ⚠

**1938 Grille Center Strip**



**597988 ..... 38**  
This is a center strip for the grille.  
1.268-0.15  
..... **\$88.75 EA** ⚠

**1938 Grille Center Strip Clip**



**597463 ..... 38**  
Clips for center strip.  
Uses 2. 1.269-0  
..... **CALL** ⚠

**1938 Crank Hole Cover**



**597719 ..... 38**  
2 pieces 1.274-0.15  
..... **\$59.25 SET** ⚠

**1939 Grille**

**350422 ..... 39**  
W/ center strip-chrome (not for show)  
1.266-0  
..... **CALL** ⚠



**350422NC ..... 39**  
W/ center strip (bare steel). 17 bars.  
1.266-0  
..... **CALL** ⚠

**1939 Grille Center Strip**



**580814 ..... 39**  
21-3/4in. 1.268-0  
..... **CALL** ⚠

**1939 Grille Lettering**



**350422L ..... 39**  
Top grille bar-vinyl. 1.266-0.15  
..... **\$23.50 EA** ⚠

**1940 Grille**

**3653523 ..... 40**  
W/ center strip-chrome (not for show)  
1.266-0  
..... **CALL** ⚠

**1940 Grille Center Strip**



**3653529 ..... 40**  
20-1/4in. 1.268-0  
..... **CALL** ⚠

**1940 Grille Lettering**



**3653523A ..... 40**  
Red vinyl, includes stripes. 1.266-0.15  
..... **\$19.00 EA** ⚠

**1941-46 Grille**

**3657169NC ..... 41-46**  
Upper half only - bare steel. 1.266-0.15  
..... **\$185.25 EA** ⚠



**3657185 ..... 41-46**  
Upper & lower, chrome (not for show). (exc COE) 1.266-0  
..... **CALL** ⚠



**3657185NC ..... 41-46**  
Upper & lower. Bare steel (exc COE).  
1.266-0.15 ..... **\$898.75 EA** ⚠

**1941-46 Grille, cont.**

**3657185NCNL ..... 41-46**  
Upper & Lower. Bare steel without logo.  
1.266-0  
..... **CALL** ⚠

**1941-46 Crank Hole Cover**



**3658076 ..... 41-46**  
Crank Hole Cover- Polished Stainless - For original grills only  
1.274-0.15  
..... **\$83.75 EA** ⚠

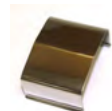

**3658076R ..... 41-46**  
Crank Hole Cover- Polished Stainless - For reproduction grills only  
1.274-0.15  
..... **\$83.25 EA** ⚠

**1941-46 Grille Screw Set**



**3651169 ..... 41-46**  
Upper grille to fender.  
1.269-0.15  
..... **\$8.25 SET** ⚠

**3657169A ..... 41-46**  
Upper grille to lower grille. 1.266-0.15  
..... **\$7.25 SET** ⚠

**1941-46 Grille Emblem**



**3657269 ..... 41-46**  
Lower. 1.303-0.15  
..... **\$39.25 EA** ⚠

**1941-46 Grille Lettering**



**3657186 ..... 41-46**  
Red vinyl. 1.266-0.15 ..... **\$21.00 SET** ⚠

**1941-46 Grille Filler Panel**



**3664734 ..... 41-46**  
Upper grille baffle. Fits between upper grille & radiator. Fiberglass. 1/2Ton & 3/4Ton. 1.286-0.15 ..... **\$107.25 EA** ⚠

**1941-46 Grille Filler Panel, cont.**



**606785FP** ..... **.41-46**  
Lower grille filler panel, fiberglass. Fits all exc. COE 1.286-0.15 ..... **\$191.25 EA** ⚠

**1941-46 Grille Moulding Clips**



**597522A** ..... **.41-46**  
For moulding above lower grille (8 pcs).

8.005-0.3 ..... **\$6.50 SET** ⚠

**1941-46 Panel Below Grille**



**3680810** ..... **.41-46**  
Fiberglass. 1.266-0.15 .. **\$120.25 EA** ⚠



**3680810G** ..... **.41-46**  
GMC fiberglass. 1.266-0.15 . **\$155.25 EA** ⚠



**3680810GS** ..... **.41-46**  
GMC fiberglass w/out bumper cutouts street rod application. 1.266-0.15 ..... **\$155.25 EA** ⚠



**3680810S** ..... **.41-46**  
Fiberglass w/out bumper cutouts street rod application. 1.266-0.15 . **\$155.25 EA** ⚠

**1941-46 Panel Below Grille, cont.**



**3680810SC** ..... **.41-46**  
Steel with bumper cutouts 1.266-0 ..... **\$204.00 EA** ⚠



**3680810SM** ..... **.41-46**  
Steel w/out bumper cutouts street rod application. 1.266-0 ..... **CALL** ⚠

**1947-53 Grille Bolt Kit**



**3650205B**... **.47-53**  
Grille 1.269-0.3 ..... **\$17.75 SET** ⚠

**1947-53 Grille**



**3847340**..... **.47-53**  
Chrome and painted, pre-assembled very nice. 1.266-0 ..... **\$372.00 EA** ⚠



**3847340B** ..... **.47-53**  
Billet aluminum for Chevy Trucks. 1.266-0 ..... **\$1,595.00 EA** ⚠



**3847340BA** ..... **.47-53**  
Billet aluminum for Chevy Trucks with movable "CHEVROLET" lettering. 1.266-0 ..... **\$1,775.00 EA** ⚠

**1947-53 Grille, cont.**



**3847340BAP** ..... **.47-53**  
Billet aluminum for Chevy Trucks with movable "CHEVROLET" lettering and polished face. 1.266-0 **\$2,295.00 EA** ⚠



**3847340BP** ..... **.47-53**  
Billet aluminum for Chevy Trucks with polished face 1.266-0 **\$1,850.00 EA** ⚠



**3847340C** ..... **.47-53**  
All chrome, front and rear. Pre-assembled very nice. 1.266-0.15 ..... **\$499.50 EA** ⚠

**3847340I**..... **.47-53**  
Chrome and painted cream, pre-assembled very nice. 1.266-0 ..... **\$399.00 EA** ⚠

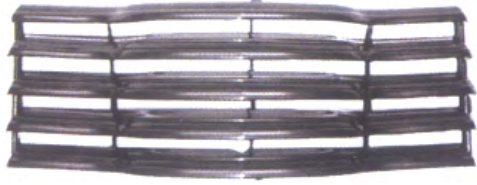

**3847340P** ..... **.47-53**  
Painted. Nice detail. Preassembled. 1.266-0.15 ..... **\$382.25 EA** ⚠

**3847354** ..... **.47-53**  
Grill For Big Trucks 1-1/2 T and 2T Plain Steel 5 Individual Bars, Lower 4 Will Fit COE. Will need to use your old back splash 1.266-0 ..... **\$500.00 EA** ⚠

**2250239** ..... **.49-54**  
Chrome-detailed, preassembled very nice. GMC (exc COE). 6.076-0.15 .. **\$656.75 EA** ⚠

**WARNING:** Cancer and Reproductive Harm — [www.P65Warnings.ca.gov](http://www.P65Warnings.ca.gov)

Chemicals shipped domestic ground only (Lower 48 states only). No international shipping.

**Phone: (360) 816-0211 • (800) 999-CHEV (2438) • www.chevsofthe40s.com**

**Grille Guard**



**986153A** ..... **47-53**  
 Front Grille Guard Accessory 17000.000 -0.15  
 ..... **\$82.75 SET** ⚠️

**Grille Filler Panel**



**3683583** ..... **47-53**  
 Lower grille, EDP coated steel. 1.286 -0.15  
 ..... **\$157.00 EA** ⚠️

**1954 Grille**



**3700339B** ..... **54**  
 Chrome plated. Comes assembled.  
 1.268 -0.15 ..... **\$1,100.00 EA** ⚠️

**1954 Grille Vertical Bar**



**3701112** ..... **54**  
 Vertical center grille bar. Chrome.  
 1.268 -0.15  
 ..... **\$158.00 EA** ⚠️



**3701112A** ..... **54**  
 Unplated Center Grille Bar. 1.268 -0.15  
 ..... **\$64.25 EA** ⚠️

**1954 Grille Bolt Kit**



**3701113A** ..... **54**  
 Grille (84 pieces). 1.269 -0.15 ..... **\$24.00 EA** ⚠️

**1954 Grille Decals**



**3710929C** ..... **54**  
 For chrome grille & hood emblem.  
 8.055 -0.15 ..... **\$12.00 SET** ⚠️



**3710929P** ..... **54**  
 For painted grille & hood emblem.  
 8.055 -0.15 ..... **\$12.00 SET** ⚠️

**1955 (1st Series) Grille Decals**



**3701185C** ..... **55**  
 (1st series exc D-D) for chrome grille & hood emblem. 8.055 -0 ..... **\$13.25 SET** ⚠️



**3701185P** ..... **55**  
 (1st series) for painted grille & hood emblem. 8.055 -0 ..... **\$14.50 SET** ⚠️

**Core Support Pads & Shims**



**367314** ..... **39-46**  
 Radiator core support mount. 4-1/4" x 1-1/2" (2-1/2" between bolt holes).  
 1.270 -0.3 ..... **\$10.50 SET** ⚠️



**3684763A** ..... **47-49**  
 Radiator core support mount. 2-1/4" x 1-1/4" x 1/4" thick. 1.270 -0.15  
 ..... **\$9.00 SET** ⚠️



**3684763** ..... **50-54**  
 Radiator core support mount. 1.270 -0.15  
 ..... **\$6.75 PR** ⚠️

**Core Support Bolt Kit**



**3676480** ..... **41-54**  
 Radiator core support to frame. 1.270 -0.4  
 ..... **\$4.00 SET** ⚠️

**Brace (V-Rod)**



**594773** ..... **37-38**  
 For 37-38 Chevy Trucks. Stainless Steel.  
 1.309 -0 ..... **CALL** ⚠️

**Odds & Ends**

Please call for availability on all Odds & Ends parts; once part is sold, it may no longer be in stock.  
**5936674** ..... **46-48**  
 Rim (trim ring) for spotlight (NOS)  
 7.000 -0.4  
 ..... **\$15.00 EA** ⚠️



**SECTION 250T  
STREET ROD PARTS**

**Fiberglass Hood**



**602345F** ..... **37**  
1-piece top section. 8.001-0 **CALL** ⚠



**602985F** ..... **38**  
1-piece top section. 8.001-0 **CALL** ⚠



**3701466F** ..... **47-55**  
1-piece top section. 8.000-0 **CALL** ⚠

**Fiberglass Hood Sides**

**602346F** ..... **37**  
Hood sides, smooth 8.001-0 **CALL** ⚠



**602346FS** ..... **37**  
Hood sides, original style. 8.001-0 ..... **CALL** ⚠

**SECTION 250T  
RESTORATION PARTS**

**Hood Deflector**

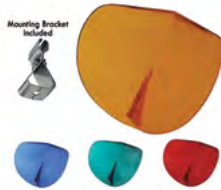

**C5018** ..... **ALL**  
Classic "Bi-Flector" accessory attaches to hood center strip. Choose Amber, Blue, Clear, Green or Red. -0 ..... starting at **\$13.00 EA** ⚠

**Hood Hinge Kits**



**TILTHD** ..... **ALL**  
Kit makes it easy to reverse the tilt on your hood! Not only does it give you a custom look, it also allows for easy access and maximum visibility! Easy installation, universal application. High Strength Black Finish. Adjustable kit ships with detailed instructions. -0.15 .... **\$250.00 KIT** ⚠

**Hood Latch Lower Assembly**



**3682709C** ..... **47-53**  
Hood latch assembly fits above grille. Chrome. Includes latch. Chevrolet Only, will not fit GMC. 8.080-0.15 .... **\$254.25 EA** ⚠



**3682709P** ..... **47-53**  
Hood latch assembly fits above grille, black. Includes latch. Chevrolet Only, will not fit GMC. 8.080-0.15 .... **\$152.00 EA** ⚠

**Hood Latch Plate**



**2228975** ..... **47-53**  
Hood latch assembly fits above Grille. Includes latch. Fits GMC. 6.079-0.15 **\$179.50 EA** ⚠

**Hood Latch Assembly**



**3682707A** ..... **47-53**  
Mechanism only. 8.080-0.15 ..... **\$65.25 EA** ⚠



**3684297A** ..... **47-55**  
Upper hood latch handle return spring with clevis and cotter pin 8.083-0.15 ..... **\$13.00 SET** ⚠

**Hood Center Strip**



**3681480** ..... **47-55**  
For hood bullnose-steel w/ clips will not fit GMC. 55-1/4" length, tip-to-tip. 8.015-0 ..... **\$75.00 EA** ⚠



**3681480S** ..... **47-55**  
Truck, stainless steel w/ clips. Will not fit GMC. 8.015-0.15 ..... **\$88.00 EA** ⚠

**3681480SG** ..... **47-55**  
Truck, stainless steel w/ clips. GMC. 8.015-0.15 ..... **\$83.25 EA** ⚠



**WARNING:** Cancer and Reproductive Harm — [www.P65Warnings.ca.gov](http://www.P65Warnings.ca.gov)

Chemicals shipped domestic ground only (Lower 48 states only). No international shipping.

**Phone: (360) 816-0211 • (800) 999-CHEV (2438) • [www.chevsofthe40s.com](http://www.chevsofthe40s.com)**

**Hood Ornament**



**595591..... 37**  
This is a beautiful chrome hood ornament for '37. 1.265 -0 ..... **CALL** ⚠️



**598015..... 38**  
This is a beautiful chrome hood ornament for 1938 Chevrolet truck. 1.265 -0 ..... **CALL** ⚠️



**358085.....39-40**  
This is a beautiful chrome hood ornament. 1.265 -0 ..... **CALL** ⚠️



**986162.....47-53**  
Accessory (original 47-52). 1.265 -0.15 ..... **\$109.75 EA** ⚠️



**986982..... 53**  
Accessory 1.265 -0 ..... **CALL** ⚠️

**Hood Emblem**



**3684340 .....47-53**  
Front of Hood - Stainless. Commercial exc D-D 8.055 -0.15 ..... **\$60.00 EA** ⚠️

**Hood Emblem, cont.**



**3699021A .....47-53**  
Hood emblem set-script. Red "Chevrolet" & stripes, blue "Bowtie". 8.055 -0.15 ..... **\$10.00 EA** ⚠️



**3701185 .....54-55**  
Front of Hood - Stainless. 8.055 -0.15 ..... **\$210.00 EA** ⚠️

**Hood Emblem Gasket**



**3699021B .....47-53**  
Hood emblem. 8.055 -0.15 ..... **\$10.00 EA** ⚠️



**3710929A ..... 54**  
Hood emblem. 8.055 -0.15 ..... **\$5.25 EA** ⚠️

**Grille Decals**



**3710929C ..... 54**  
For chrome grille & hood emblem. 8.055 -0.15 ..... **\$12.00 SET** ⚠️



**3710929P ..... 54**  
For painted grille & hood emblem. 8.055 -0.15 ..... **\$12.00 SET** ⚠️

**Hood Emblem Gasket**



**3701185C ..... 55**  
(1st series exc D-D) for chrome grille & hood emblem. 8.055 -0 ..... **\$13.25 SET** ⚠️



**3701185P ..... 55**  
(1st series) for painted grille & hood emblem. 8.055 -0 ..... **\$14.50 SET** ⚠️

**Hood Side Emblem**



**474797 .....36-38**  
Bowtie all chrome. 8.039 -0.15 ..... **\$60.00 EA** ⚠️



**474797A .....36-38**  
Bowtie painted-superior quality. 8.039 -0 ..... **\$39.00 EA** ⚠️



**3683134 .....47-48**  
Chevrolet Thriftmaster. 8.039 -0.15 ..... **\$22.75 EA** ⚠️



**2313213 .....47-54**  
GMC, painted white w/ red. 10.096 -0.15 ..... **\$85.25 PR** ⚠️

**Hood Side Emblem, cont.**



**3692106** ..... **49-51**  
3100 8.039 -0.15 ..... **\$15.50 EA** ⚠



**3699024** ..... **49-52**  
Chevrolet. 8.039 -0.15 .. **\$45.00 PR** ⚠



**3700202** ..... **53-54**  
3100 8.039 -0.15 ..... **\$37.50 PR** ⚠

**Hood Side Moulding**



**350631B** ..... **39-40**  
Excellent reproduction with painted details. 8.005 -0.15 ..... **\$98.25 PR** ⚠



**3657265** ..... **41-46**  
Left 8.005 -0.15 ..... **\$19.00 EA** ⚠



**3657266** ..... **41-46**  
Right 8.005 -0.15 ..... **\$19.00 EA** ⚠

**Hood Side Clips & Bolts**



**350507** ..... **39-40**  
Side moulding clip. Sold as each. 8.005 -0.15 ..... **\$3.25 EA** ⚠

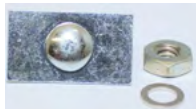

**350651** ..... **39-40**  
Side moulding. 1 side requires 1 stud 8.005 -0.15 ..... **\$3.50 EA** ⚠



**59752346** ..... **41-46**  
Does 1 moulding. Drilling new holes is required 8.005 -0 ..... **\$7.75 SET** ⚠

**Hood Handle**



**597521A** ..... **36-46**  
Stainless 37-39 Cars  
36-46 Trucks. 8.030 -0.15

..... **\$50.25 EA** ⚠



**597521P** ..... **36-46**  
Plain steel, primered. Paintable, as original. Chrome 37-39 Cars 36-46 Trucks. 8.030 -0

..... **CALL** ⚠

**Adhesives & Sealers**



**01608** ..... **ALL**  
3M plastic & emblem adhesive (5 oz. tube). 8.800 -0.15 ..... **\$9.75 EA** ⚠

**Underhood Light**



**986250** ..... **47-48**  
Super reproduction. 8.890 -0 ..... **CALL** ⚠

**Hood Corners**



**3678834** ..... **37-38**  
Rubber front. 8.024 -0.2 ..... **\$12.00 PR** ⚠

**3678834** ..... **39-46**  
Rubber rear. 8.024 -0.2 ..... **\$12.00 PR** ⚠

**Bumpers (Rubber)**



**595304** ..... **37**  
Hood to grille shell (6 pcs). 8.024 -0 ..... **\$6.00 SET** ⚠



**3681093B** ..... **38-46**  
Hood to grille shell (6 pcs). 8.024 -0.3 ..... **\$6.00 SET** ⚠

**Bumpers (Rubber), cont.**



**3676360B** ..... **47-54**  
Hood set (10 pcs). 8.024 -0.3 ..... **\$10.00 SET** ⚠

**Retainers w/ Screws**



**3654168B** ..... **29-54**  
For hood to cowl seal (Set of 8). 9.127 -0.4 .. starting at **\$8.00 SET** ⚠

**Hood To Cowl Seal**



**374969** ..... **29-46**  
Webbing with wire insert. 9.127 -0.15 ..... **\$26.00 PR** ⚠



**374969A** ..... **29-46**  
Webbing-also radiator shell to hood (9 ft). 9.127 -0.2 ..... **\$12.00 EA** ⚠



**3658468A** ..... **41-46**  
2 44 in. rubber strips. 9.127 -0.15 ..... **\$18.00 PR** ⚠



**3688792** ..... **47-55**  
2 32-1/2 in. rubber strips. 9.127 -0.15 ..... **\$16.25 PR** ⚠

**3664008BULK** ..... **ALL**  
Rubber sold by the inch 9.127 -0 ..... **\$0.50 IN** ⚠

**Hood To Grille Seal**



**374969C** ..... **31-40**  
Webbing with wire insert. 9.127 -0.15 ..... **\$21.99 EA** ⚠



**3660532** ..... **37-46**  
Webbing with wire insert. 9.127 -0.15 ..... **\$17.00 PR** ⚠

**Hood Hinge Bracket**



**473987** ..... **34-46**  
Bracket for hood hinge hold down (rear). 8.058 -0.15 ..... **\$14.25 EA** ⚠

**473987S** ..... **34-46**  
Stainless. Rear hood hinge hold down. -0.15 ..... **\$20.00 EA** ⚠

# Section 250T: Hoods, Hinges, Springs, Rubber, Emblems & Ornaments

## Hood Hinge



**372828** ..... **34-40**  
 Chrome with fasteners (exc COE). 8.015 -0  
 ..... **\$112.25 SET** ⚠

**372828P** ..... **34-40**  
 Painted with fasteners (exc COE).  
 8.015 -0.15  
 ..... **\$67.25 SET** ⚠



**3657264** ..... **41-46**  
 Chrome with fasteners (exc COE). 8.015 -0  
 ..... **\$112.25 SET** ⚠

**3657264P** ..... **41-46**  
 Painted with fasteners (exc COE).  
 8.015 -0.15  
 ..... **\$81.25 SET** ⚠



**3686039** ..... **47-54**  
 Upper & lower (left).  
 8.015 -0.15  
 ..... **\$46.50 SET** ⚠

**3686040** ..... **47-54**  
 Upper & lower (right). 8.015 -0.15  
 ..... **\$46.50 SET** ⚠

## Hood Hinge Bolt



**3688414** ..... **47-54**  
 1/2 in. hex head, 3/8  
 in" shoulder shoulder  
 commercial utility (exc  
 COE) (uses 2). 8.016 -0.15

..... **\$5.50 PR** ⚠



**3688414S** ..... **47-54**  
 Stainless steel.  
 Shouldered-1/2 in. hex  
 head, 3/8 in. shoulder  
 commercial utility (exc

COE) (uses 2). 8.016 -0

..... **\$15.00 PR** ⚠



**3689234** ..... **47-54**  
 5/8 in. hex head, 7/16  
 in. shoulder, shoulder  
 commercial utility (exc  
 COE) (uses 4). 8.016 -0.15

..... **\$5.50 PR** ⚠



**3689234S** ..... **47-54**  
 Stainless steel 5/8  
 in. hex head, 7/16 in.  
 shoulder. Fits Comm &  
 Utility (exc COE) (uses

4). 8.016 -0

..... **\$15.00 PR** ⚠

## Odds & Ends

Please call for availability on all Odds & Ends parts; once part is sold, it may no longer be in stock.

**3657264U** ..... **41-46**  
 Hood hinge (Used). 8.015 -0.4  
 ..... **\$60.00 EA** ⚠





# Section 270T: Fenders, Fender Skirts, Fender Welting, Fender Gaskets, Mud Flaps, Hardware & Mouldings

## SECTION 270T STREET ROD PARTS

### Fender Front (Fiberglass)



- 594955L** ..... **37-38**  
Left. 8.130 -0.15 ..... **\$525.00 EA** ⚠
- 594956R** ..... **37-38**  
Right. 8.130 -0.15 ..... **\$525.00 EA** ⚠
- 599991L** ..... **39-40**  
Left. 8.130 -0.15 ..... **\$425.00 EA** ⚠
- 599992R** ..... **39-40**  
Right. 8.130 -0.15 ..... **\$525.00 EA** ⚠
- 3664961L** ..... **41-46**  
Left. 8.130 -0 ..... **CALL** ⚠
- 3664962R** ..... **41-46**  
Right. 8.130 -0 ..... **CALL** ⚠
- 3682657L** ..... **47-53**  
Left. 8.130 -0.15 ..... **\$525.00 EA** ⚠
- 3682658R** ..... **47-53**  
Right. 8.130 -0.15 ..... **\$525.00 EA** ⚠

### Fender Rear (Fiberglass)



- 594181L** ..... **37-38**  
Left. 8.203 -0.15 ..... **\$425.00 EA** ⚠
- 594181W** ..... **37-38**  
Left 2" Wider. 8.203 -0.15 ..... **\$436.25 EA** ⚠
- 594182R** ..... **37-38**  
Right. 8.203 -0.15 ..... **\$425.00 EA** ⚠
- 594182W** ..... **37-38**  
Right 2" Wider. 8.203 -0.15 ..... **\$435.00 EA** ⚠
- 599295L** ..... **39**  
Left (1/2, 3/4 & 1T). 8.203 -0.15 ..... **\$436.25 EA** ⚠

### Fender Rear (Fiberglass), cont.

- 599296R** ..... **39**  
Right (1/2, 3/4 & 1T). 8.203 -0.15 ..... **\$436.25 EA** ⚠
- 599121L** ..... **39-46**  
Left (Panel, Suburban). 8.164 -0 ..... **CALL** ⚠
- 599122F** ..... **39-46**  
Right (Panel, Suburban). 8.164 -0 ..... **CALL** ⚠
- 3681977L** ..... **40-46**  
Left 8.203 -0.15 ..... **\$436.25 EA** ⚠
- 3681977W** ..... **40-46**  
Left, 2" wider, exc 1T. 8.203 -0 ..... **CALL** ⚠
- 3681978R** ..... **40-46**  
Right 8.203 -0.15 ..... **\$436.25 EA** ⚠
- 3681978W** ..... **40-46**  
Right, 2" wider, exc 1T. 8.203 -0 ..... **CALL** ⚠
- 3682835L** ..... **47-54**  
Left (all pickups). 8.203 -0.15 ..... **\$450.00 EA** ⚠
- 3682835W** ..... **47-54**  
Left, 2-1/2" wider, all pickups. 8.203 -0.15 ..... **\$457.75 EA** ⚠
- 3682836R** ..... **47-54**  
Right (all pickups). 8.203 -0.15 ..... **\$450.00 EA** ⚠
- 3682836W** ..... **47-54**  
Right, 2-1/2" wider, all pickups. 8.203 -0.15 ..... **\$457.75 EA** ⚠

- 3684691L** ..... **47-54**  
Left (Panel, Suburban). 8.203 -0.15 ..... **\$458.00 EA** ⚠
- 3684692R** ..... **47-54**  
Right (Panel, Suburban). 8.203 -0.15 ..... **\$458.00 EA** ⚠

### Inner Fender Apron Kit Street Rod Style



- 3686239** ..... **47-54**  
Inner fender Apron Kit. Cleans look of engine bay. Bolt-in. Stock or Smooth firewalls/ core supports. Chevrolet Only 16.545 -0.15 ..... **\$415.00 SET** ⚠

### Inner Fender Panel (Fiberglass) Front

- 595889F** ..... **37-38**  
Left. 8.164 -0 ..... **CALL** ⚠
- 595890F** ..... **37-38**  
Right. 8.164 -0 ..... **CALL** ⚠

### Headlight Bucket Stand



- 350777F** ..... **37-40**  
Fiberglass, left. 2.544 -0



- ..... **CALL** ⚠
- 350778F** ..... **37-40**  
Fiberglass, right. 2.544 -0

- ..... **CALL** ⚠

### Clutch Head Driver



- DRIVER** ..... **ALL**  
Magnetic clutch head driver, Chev's imprint. w/ 5 bits (1/8 in., 5/32 in., 3/16 in., 1/4 in., 5/16 in.) 8.821 -0 ..... **\$22.25 SET** ⚠

### Clutch Head Socket Set



- CHSS-4** ..... **ALL**  
4 pc. 3/8 Drive. Includes 5/16", 1/4", 3/16", 5/32" sockets. 8.821 -0.15 ..... **\$20.50 SET** ⚠

## SECTION 270T RESTORATION PARTS

### Fender Front (Steel)

Note: Steel fenders ship EDP coated to protect from rust. Oversize shipping charges apply. Please call for rates.



- 3682481** ..... **47-53**  
Left side. Metal. Exc COE. 8.130 -0.15 ..... **\$462.50 EA** ⚠
- 3682482** ..... **47-53**  
Right side. Metal. Exc COE. 8.130 -0.15 ..... **\$462.50 EA** ⚠



**WARNING:** Cancer and Reproductive Harm — [www.P65Warnings.ca.gov](http://www.P65Warnings.ca.gov)

Chemicals shipped domestic ground only (Lower 48 states only). No international shipping.

Phone: (360) 816-0211 • (800) 999-CHEV (2438) • [www.chevsofthe40s.com](http://www.chevsofthe40s.com)

270T

# Section 270T: Fenders, Fender Skirts, Fender Welting, Fender Gaskets, Mud Flaps, Hardware & Mouldings

## Fender Front (Steel), cont.



**3682481A** .....47-55  
Left side repair, back of front fender.  
8.130-0.15 ..... **\$114.50 EA** ⚠

**3682482A** .....47-55  
Right side repair, back of front fender.  
8.130-0.15  
..... **\$114.50 EA** ⚠



**3700181** .....54-55  
Left side. Metal. Fits 1st Series, Exc COE.  
8.130-0.15 ..... **\$454.00 EA** ⚠

**3700182** .....54-55  
Right side. Metal. Fits 1st Series, Exc  
COE. 8.130-0.15  
..... **\$477.00 EA** ⚠

## Fender Rear (Steel)

**3681977** .....40-46  
Left, all commercial cabs (exc. KF, AN, BN,  
DS) 8.203-0 ..... **\$1,096.00 EA** ⚠

**3681978** .....40-46  
Right, all commercial cabs (exc. KF, AN,  
BN, DS) 8.203-0  
..... **\$1,096.00 EA** ⚠



**3682835S** .....47-54  
Left 8.203-0 ..... **\$425.00 EA** ⚠

**3682836S** .....47-54  
Right 8.203-0  
..... **\$425.00 EA** ⚠

## Inner Fender Panel (Steel) Front



**3683076** .....47-53  
Right. 8.153-0.15 ..... **\$133.50 EA** ⚠



**3687381** .....47-53  
Left. 8.153-0.15 ..... **\$133.50 EA** ⚠

## Bolt & Washer Set

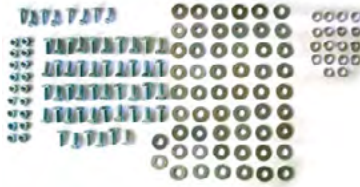

**3682481BZ** .....47-55  
Front fender. Zinc plated. 8.130-0 .....  
**\$12.00 SET** ⚠

## Gasket Set



**3701900A** .....41-46  
Inner panel w/ lower rear mount pads.  
8.154-0.15 ..... **\$30.00 SET** ⚠



**3701900C** .....47-54  
Inner panel & front fender (8 pcs).  
8.154-0.15 ..... **\$19.00 SET** ⚠

## Fender Gaskets



**609725** .....47-54  
Fender to cowl (die cut). 8.205-0.15 .....  
**\$23.00 SET** ⚠

## Fender Welting

**601726A** .....27-46  
Set (4 fenders). 8.205-0.2  
..... **\$22.00 SET** ⚠

**601726E** .....37-54  
Rear fenders (optional 47-54). 8.205-0.2  
..... **\$20.00 PR** ⚠

**609275B** .....47-54  
Set (4 fenders) (optional). 8.205-0.15  
..... **\$20.50 SET** ⚠

**601726** ..... ALL  
Black 1/4in. x 1-3/16in. 37-48 rear  
fenders use approx 15 ft. r-0  
..... **\$1.00 FT** ⚠

## Fender Welting Chrome Mylar

**601726F** .....37-54  
Chrome mylar rear (optional 47-54).  
8.205-0  
..... **\$35.00 PR** ⚠



**601726C** ..... ALL  
Chrome mylar (1-1/4" x 3/16"). 8.205-0  
..... **\$2.00 FT** ⚠

## Deluxe Fender Mouldings



**3676203** .....47-55  
Left and right upper fender moulding  
8.132-0.15 ..... **\$232.00 L&R** ⚠

**3676204** .....47-55  
12 piece set with mounting hardware. For  
lower rear of fenders. 8.132-0.15  
..... **\$1,741.00 SET** ⚠



# Section 270T: Fenders, Fender Skirts, Fender Welting, Fender Gaskets, Mud Flaps, Hardware & Mouldings

## Fender Marker (Guide)



**985134** .....**37-54**  
Illuminated. Clamps to front fender, chrome plated. Milky colored top w/ clear lens & stainless fin. 15.5" tall -0.15  
..... **\$84.25 PR** ⚠



**985134BULB** .....**ALL**  
Replacement bulb. 3 watt, 12 volt threaded base -0.15  
..... **\$1.00 EA** ⚠



**985135** .....**ALL**  
lighted Fender Guide, Chrome With Green, Red, Blue Or Amber  
Inserts -0.15  
..... **\$65.00 PR** ⚠

## Curb Feelers



**985289A** .....**ALL**  
Chrome flex wire, clamp on vintage accessory helps prevent wheel & fender damage by creating a noticeable scraping sound when vehicle is too close to the curb.  
8.214 -0.15 ..... **\$13.50 PR** ⚠



**985289B** .....**ALL**  
Chrome plated, vintage clamp on accessory helps prevent wheel & fender damage by creating a noticeable scraping sound when vehicle is too close to the curb. 8.214 -0.15 ..... **\$14.00 PR** ⚠

## Headlight Grommet



**3673139** .....**47-53**  
Fender inner panel. 9.775 -0.4  
..... **\$3.50 SET** ⚠

## Fender Clutch Head Bolt



**3681977B** .....**39-46**  
5/16in., nut, washer rear fender (3 pcs). 8.206 -0.15  
..... **\$1.50 SET** ⚠

## Fender Clutch Head Bolt, cont.

**3676478** .....**47-54**  
5/16in., nut, washer rear fender (10 per fender) (3 piece set). 8.206 -0.4  
..... **\$2.50 SET** ⚠

**3681977** .....**47-54**  
5/16in., nut, washer fender brace (3 pcs). 8.206 -0.4  
..... **\$2.50 SET** ⚠

## Fender Braces



**3654300** .....**40-46**  
These are correct for 1942-1946 but works well on 1940-1941. Fits under the top crown of the fender. 8.212 -0.15  
..... **\$22.25 EA** ⚠



**3683947** .....**47-54**  
Rear - 1/2 Ton 8.212 -0.15 ..... **\$12.75 EA** ⚠



**3683947A** .....**47-54**  
Truck rear, for 2" widened fenders. 8.212 -0.4 ..... **\$16.50 EA** ⚠



**3683947S** .....**47-54**  
Stainless, Front & rear (4 piece set). 1/2 Ton 8.203 -0.2 ..... **\$94.00 SET** ⚠



**3683947SF** .....**47-54**  
Stainless, Front. 1/2 Ton 8.203 -0.15 ..... **\$52.25 SET** ⚠



**3683947SR** .....**47-54**  
Stainless, Rear. 1/2 Ton 8.203 -0.15 ..... **\$52.25 SET** ⚠

**3683983** .....**47-54**  
Rear. 3/4 Ton 8.212 -0 ..... **\$43.75 PR** ⚠

## Fender Braces, cont.

**3683983S** .....**47-54**  
Polished Stainless. Rear, 3/4 Ton. 8.212 -0 ..... **\$62.75 PR** ⚠



**3684841** .....**47-54**  
Front fender braces 8.144 -0.15 ..... **\$22.50 L&R** ⚠



**3685644B** .....**47-54**  
Fender to Firewall 8.155 -0.15 ..... **\$45.00 PR** ⚠

## Fender Skirts



**604503P** .....**36-46**  
Fabricated 8.175 -0.15 ..... **\$327.00 L&R** ⚠



**985641** .....**36-46**  
Superb die-stamped production of 1940's original steel tear drop skirts. Includes rubber seals. 8.175 -0.15 ..... **\$521.25 L&R** ⚠

## Odds & Ends

Please call for availability on all Odds & Ends parts; once part is sold, it may no longer be in stock.

**3664975U** .....**41-46**  
Skirt extension bracket spacer left hand used 8.153 -0  
..... **\$25.00 EA** ⚠

**3694962U** .....**47-53**  
Right front fender (Used) 8.130 -0.4  
..... **\$200.00 EA** ⚠

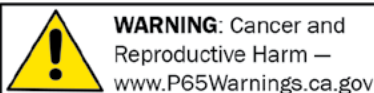

Chemicals shipped domestic ground only (Lower 48 states only). No international shipping.

Phone: (360) 816-0211 • (800) 999-CHEV (2438) • [www.chevsofthe40s.com](http://www.chevsofthe40s.com)

**Section 290T: Sill Plates, Running Board Gaskets, Step Plates, Rocker Panel Mouldings & Fasteners**

**SECTION 290T RESTORATION PARTS**

Note: Running Boards and Rocker Panels can be found in Section 295C.

**Running Board Step Plate**



**350274B** .....**47-54**  
 (super repro) very rare genuine chevrolet accessory 8.316 -0.15 ..... **\$75.00 L&R** ⚠️



**350274A**.....**ALL**  
 Chrome rim w/ rubber insert (7-5/8 in. x 10-11/16 in.) 8.316 -0 ..... **CALL** ⚠️



**350274C**.....**ALL**  
 Die cast with bowtie (5-5/16 in. x 10-7/8 in.) Does not include any hardware. 8.316 -0.15 ..... **\$58.75 L&R** ⚠️

**Running Board Bolt Kit**



**3687271B** .....**37-54**  
 Bolts, washers & nuts. 8.299 -0.4 ..... **\$12.50 SET** ⚠️

**Running Board To Fender Gaskets**



**3656703** .....**39-40**  
 Running board to fenders (4) 8.299 -0.15 ..... **\$18.00 SET** ⚠️

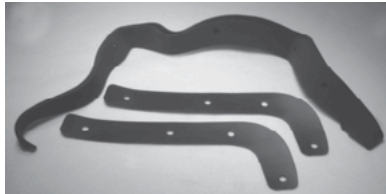

**3656703A** .....**41-46**  
 Running board to fenders (4) 8.299 -0.15 ..... **\$15.25 SET** ⚠️



**3687271A** .....**47-54**  
 Running board to rear fender 8.299 -0.15 ..... **\$8.00 PR** ⚠️

**Running Board To Cab Seal**

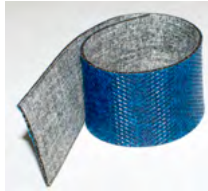

**60395540** .....**33-40**  
 (anti-squeak) to body (120 in.) 8.237 -0 ..... **\$13.00 SET** ⚠️

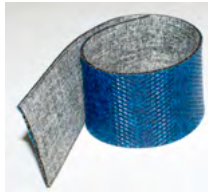

**60395546** .....**41-46**  
 Running board to body (Panel & Suburban) (120 in.) 8.237 -0.15 ..... **\$11.50 SET** ⚠️

**Running Board To Cab Seal, cont.**



**3685433** .....**47-54**  
 Running board to cab (exc Panel & Suburban). 8.205 -0.15 ..... **\$20.75 PR** ⚠️



**3685433A** .....**47-54**  
 Running board to body (Panel & Suburban). 8.205 -0.15 ..... **\$30.00 PR** ⚠️

**Metal Retainer**

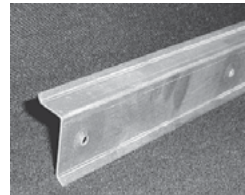

**3685433B** .....**47-55**  
 Running board to cab seal 8.205 -0.15 ..... **\$10.00 EA** ⚠️

**Screws**

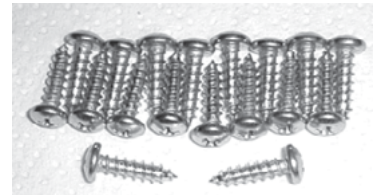

**3685433C** .....**47-54**  
 For running board to cab seal retainer (18 piece) 8.205 -0.4 ..... **\$4.00 SET** ⚠️

**1937-40 PARTS**

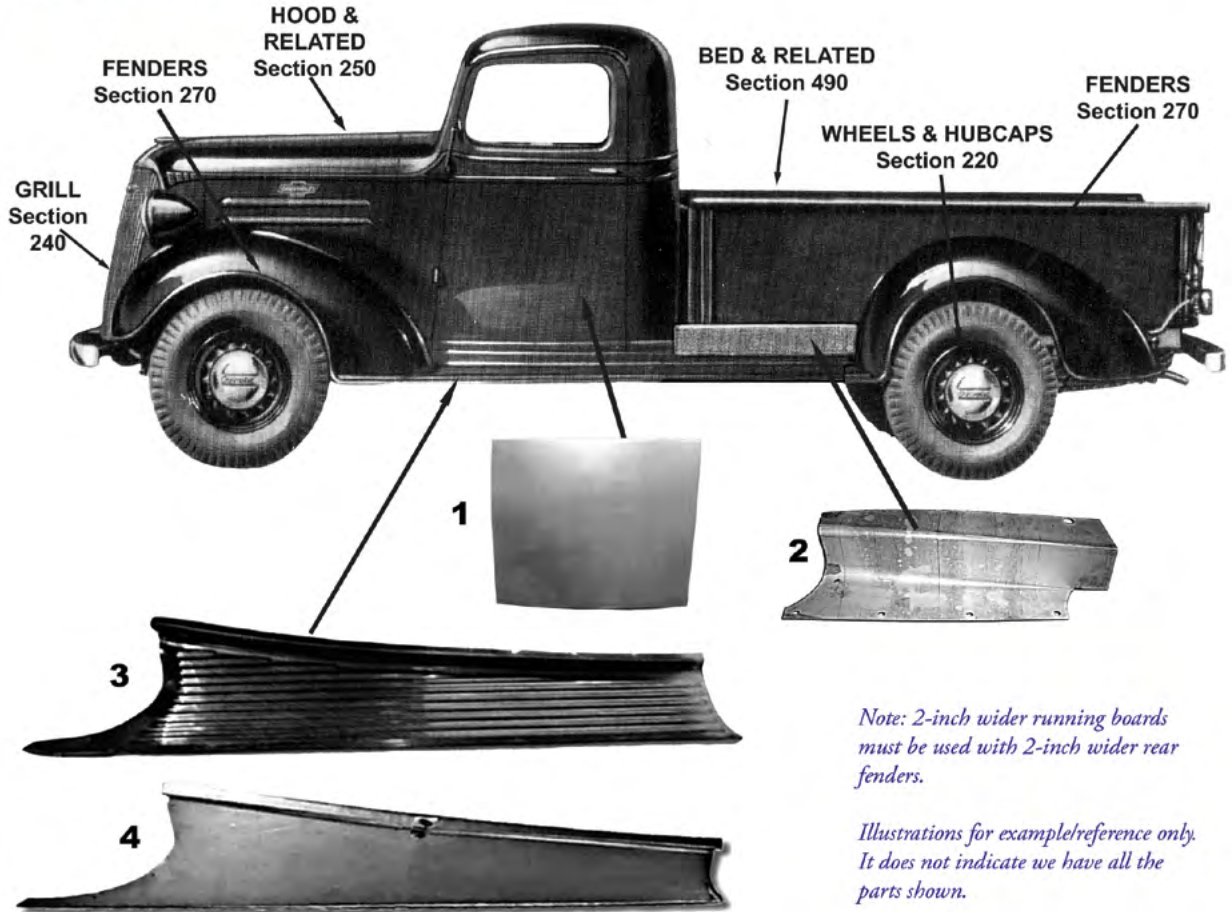

*Note: 2-inch wider running boards must be used with 2-inch wider rear fenders.*

*Illustrations for example/reference only. It does not indicate we have all the parts shown.*

**1. Door Patch Panel 1936-40**

- 602455** ..... **36-38**  
Fabricated. Outer left. 16.150 -0.15  
..... **\$139.75 EA** ⚠
- 602455A** ..... **36-38**  
Fabricated. Pickup Lower Door Skin,  
LH -0.15  
..... **\$51.75** ⚠
- 602456** ..... **36-38**  
Fabricated. Outer right. 16.150 -0.15  
..... **\$139.75 EA** ⚠
- 602456A** ..... **36-38**  
Fabricated. Pickup Lower Door Skin,  
RH -0.15  
..... **\$51.75** ⚠
- 3666518** ..... **39-46**  
Fabricated. Outer right. 16.150 -0.15  
..... **\$110.25 EA** ⚠
- 3666518A** ..... **39-46**  
Fabricated. Pickup Lower Door Skin,  
RH -0.15  
..... **\$55.50** ⚠
- 603339** ..... **39-46**  
Fabricated. Outer left. 16.150 -0.15  
..... **\$110.25 EA** ⚠
- 603339A** ..... **39-46**  
Fabricated. Pickup Lower Door Skin,  
LH -0.15  
..... **\$55.50** ⚠

**2. Side Splash Apron 1937-39**

- 599731L** ..... **37-39**  
Fabricated Left-1/2Ton. 8.228 -0.15  
..... **\$39.00 EA** ⚠
- 599732R** ..... **37-39**  
Fabricated. Right-1/2Ton. 8.228 -0.15  
..... **\$39.00 EA** ⚠

**3. Running Boards w/ Built-in Mounting Points (Fiberglass) 1937-1940**

- 594265S** ..... **37-38**  
Fiberglass-stock 1/2Ton. 8.299 -0.15  
..... **\$600.00 PR** ⚠
- 594265W** ..... **37-38**  
Fiberglass-smooth 1/2Ton (2 in. wider).  
8.299 -0.15  
..... **\$575.00 PR** ⚠
- 594266F** ..... **37-38**  
Fiberglass-smooth 1/2Ton. 8.299 -0.15  
..... **\$588.00 PR** ⚠
- 599578FS** ..... **39-40**  
Fiberglass-smooth 1/2Ton. 8.299 -0  
..... **CALL** ⚠
- 599578FW** ..... **39-40**  
Fiberglass-smooth 1/2Ton (2 in. wider).  
8.299 -0  
..... **CALL** ⚠

**4. Running Boards w/ Built-in Mounting Points (Steel) 1937-1940**

- 594266S** ..... **37-38**  
Fabricated. Smooth 16ga.cold rolled  
steel. 1/2Ton. 8.299 -0.15  
..... **\$700.50 PR** ⚠
- 594266SW** ..... **37-38**  
Fabricated. Smooth 16ga.cold rolled  
steel. 1/2Ton (2 in. wider). 8.299 -0.15  
..... **\$719.00 PR** ⚠
- 599578S** ..... **39-40**  
Fabricated. Smooth 16ga.cold rolled  
steel. 1/2Ton. 8.299 -0.15  
..... **\$698.25 PR** ⚠
- 599578SW** ..... **39-40**  
Fabricated. Smooth 16ga.cold rolled  
steel. 1/2Ton (2 in. wider). 8.299 -0.15  
..... **\$719.00 PR** ⚠

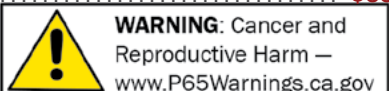

Chemicals shipped domestic ground only (Lower 48 states only). No international shipping.

**Phone: (360) 816-0211 • (800) 999-CHEV (2438) • [www.chevsofthe40s.com](http://www.chevsofthe40s.com)**

**1937-40 FABRICATED PARTS**

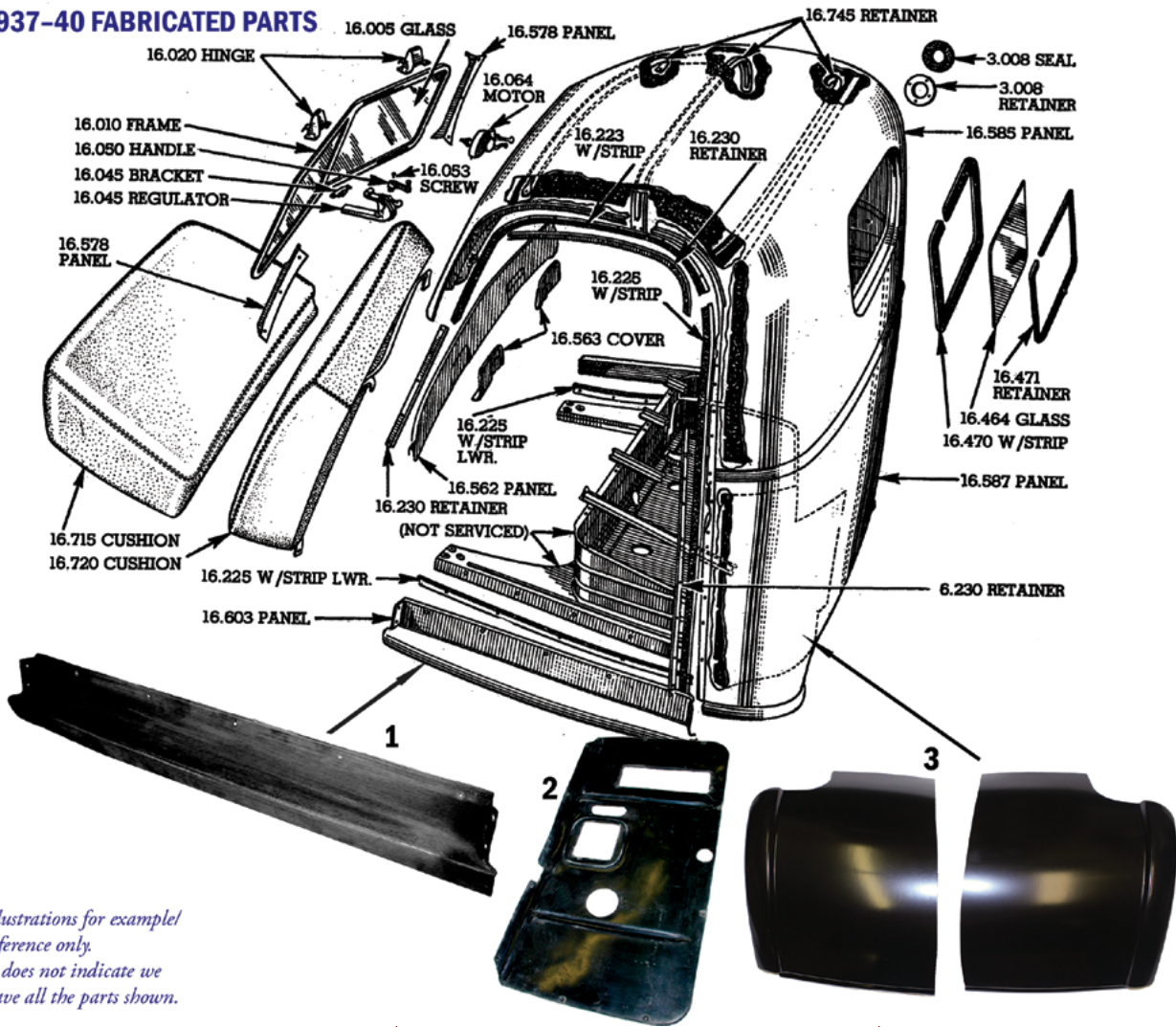

*Illustrations for example/  
reference only.  
It does not indicate we  
have all the parts shown.*

**1. Rocker Panel 1936-1940**

- 477143**..... **36-38**  
Left-fiberglass. 16.603-0  
..... **\$94.50 EA** ⚠
- 477144**..... **36-38**  
Right-fiberglass. 16.603-0  
..... **\$94.50 EA** ⚠
- 598655**..... **39-46**  
Stamped. Left-steel (as original) 16.603-0.3  
..... **\$125.00 EA** ⚠
- 598655F**..... **39-46**  
Left-fiberglass. 16.603-0  
..... **\$85.00 EA** ⚠
- 598656**..... **39-46**  
Stamped. Right-steel (as original)  
16.603-0.3  
..... **\$125.00 EA** ⚠
- 598656F**..... **39-46**  
Right-fiberglass. 16.603-0  
..... **\$85.00 EA** ⚠

**2. Floorboard 1937-40**

- 594987**..... **36-38**  
Fabricated. Pickup Front Floor Pan  
3Spd -0.15  
..... **\$124.25** ⚠
- 594987SR**..... **36-38**  
Fabricated. Pickup Front Floor Pan Rat  
Rod -0.15  
..... **\$124.25** ⚠
- 594993**..... **36-38**  
Fabricated. Pickup Front Floor Pan  
4Spd -0.15  
..... **\$124.25** ⚠
- 594993**..... **37-38**  
Door to door (fiberglass) 4-speed.  
16.545-0.15  
..... **\$108.50 EA** ⚠
- 3653207**..... **39-40**  
Fabricated. Pickup Front Floor Pan 3Spd  
1/2 Ton -0.15  
..... **\$124.25** ⚠

**2. Floorboard 1937-40, cont.**

- 3653211S**..... **39-40**  
Fabricated. Pickup Front Floor Pan 4Spd  
1/2 Ton -0.15  
..... **\$124.25** ⚠

**3. Cab Corner Patch Panel Outer 1936-40**

- 598671B**..... **36-46**  
Stamped. Outer right and left, rear.  
16.587-0.15  
..... **\$74.50 L&R** ⚠

Returns require a return authorization number—call first. • Product pricing & availability subject to change.



**WARNING:** Cancer and Reproductive Harm — www.P65Warnings.ca.gov

**1941-46 PARTS**

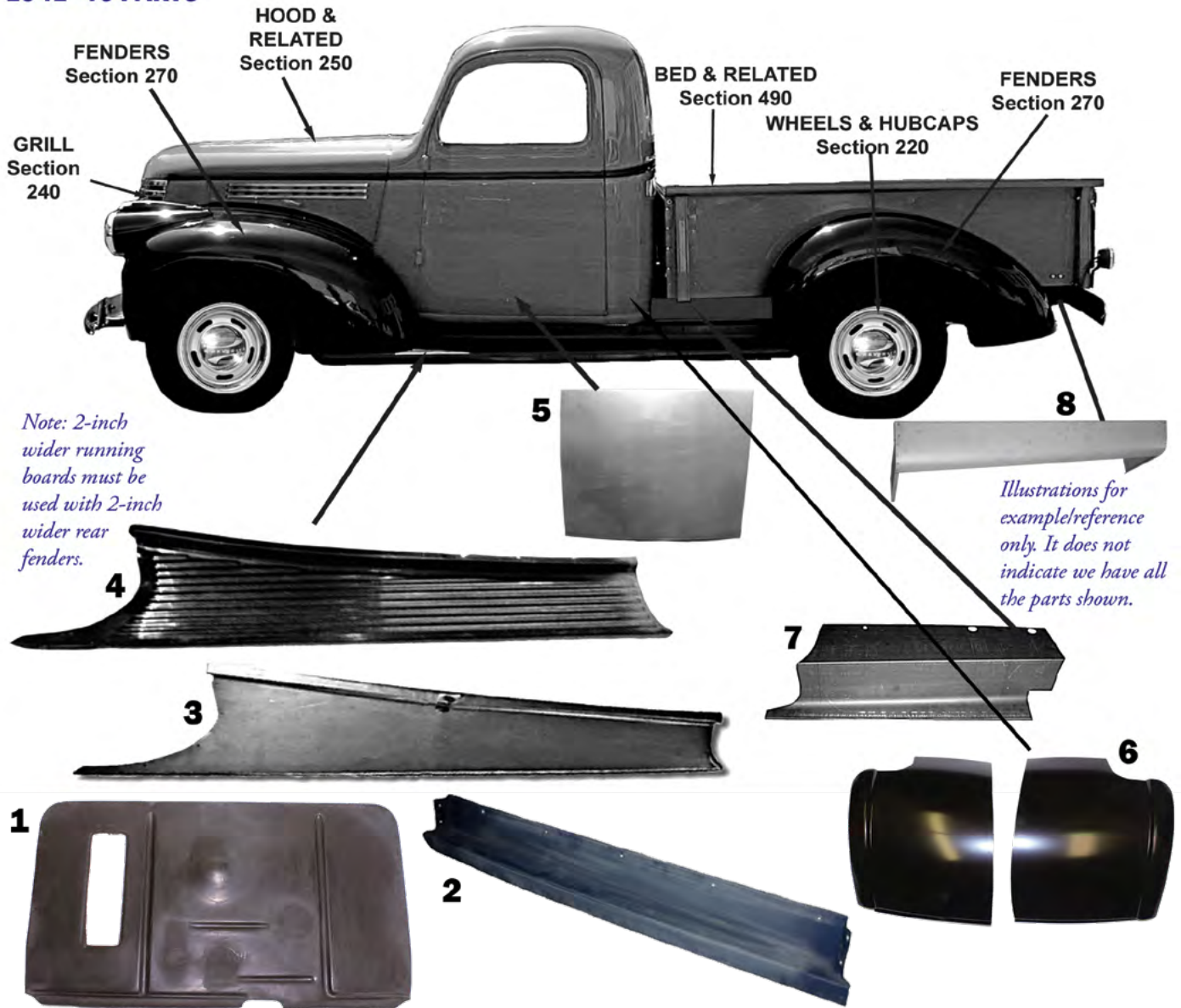

*Note: 2-inch wider running boards must be used with 2-inch wider rear fenders.*

*Illustrations for example/reference only. It does not indicate we have all the parts shown.*

**Toe Board 1941-46**

**3693869** ..... **.41-46**  
Fabricated. Pickup Front Toe Board -0.15  
..... **\$91.25** ⚠

**1. Floorboard 1941-46**

**187694B** ..... **.41-46**  
Bolt set for floor board (21 pcs).  
16.542 -0.15

..... **\$8.75 SET** ⚠  
**3681279** ..... **.41-46**  
Door to door (fiberglass), 3-speed.  
16.545 -0

..... **CALL** ⚠  
**3681279S** ..... **.41-46**  
Fabricated. Pickup Front Floor Pan 3Spd  
1/2 Ton -0 ..... **\$119.75** ⚠

**1. Floorboard 1941-46, cont.**

**3681279SR** ..... **.41-46**  
Fabricated. Pickup Front Floor Pan Rat  
Rod -0.15  
..... **\$119.75** ⚠

**3681281** ..... **.41-46**  
Fabricated. Pickup Front Floor Pan 4Spd  
3/4 Ton, 1 Ton, 1 1/2 Ton -0.15  
..... **\$119.75** ⚠

**3681395** ..... **.41-46**  
Fabricated. Pickup Front Floor Pan 4Spd  
1/2 Ton -0.15  
..... **\$119.75** ⚠

**2. Rocker Panel 1941-46**

**598655** ..... **.39-46**  
Stamped. Left-steel (as original) 16.603 -0.3  
..... **\$125.00 EA** ⚠

**2. Rocker Panel 1941-46, cont.**

**598655F** ..... **.39-46**  
Left-fiberglass. 16.603 -0  
..... **\$85.00 EA** ⚠

**598656** ..... **.39-46**  
Stamped. Right-steel (as original)  
16.603 -0.3  
..... **\$125.00 EA** ⚠

**598656F** ..... **.39-46**  
Right-fiberglass. 16.603 -0  
..... **\$85.00 EA** ⚠

**3. Running Boards w/ Built-in Mounting Pointes (Steel) 1941-46**

**3656702S** ..... **.41-46**  
Fabricated. Smooth 16ga.cold rolled  
steel. 1/2Ton. 8.299 -0.15  
..... **\$700.75 PR** ⚠

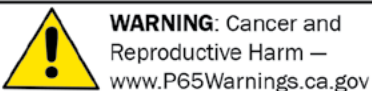

Chemicals shipped domestic ground only (Lower 48 states only). No international shipping.

**Phone: (360) 816-0211 • (800) 999-CHEV (2438) • www.chevsofthe40s.com**

**3. Running Boards w/ Built-in Mounting Pointes (Steel) 1941-46, cont.**

**3656702SW.....41-46**  
Fabricated. Smooth 16ga.cold rolled steel. 1/2Ton (2 in. wider). 8.299 -0.15  
..... **\$719.00 PR** ⚠

**4. Running Boards w/ Built-in Mounting Points (Fiberglass) 1941-46**

**3656702F .....41-46**  
Fiberglass-smooth 1/2Ton. 8.299 -0  
..... **CALL** ⚠

**5. Door Patch Panel 1941-46**

**3666518 ..... 39-46**  
Fabricated. Outer right. 16.150 -0.15  
..... **\$110.25 EA** ⚠

**3666518A .....39-46**  
Fabricated. Pickup Lower Door Skin, RH -0.15  
..... **\$55.50** ⚠

**603339 ..... 39-46**  
Fabricated. Outer left. 16.150 -0.15  
..... **\$110.25 EA** ⚠

**603339A .....39-46**  
Fabricated. Pickup Lower Door Skin, LH -0.15  
..... **\$55.50** ⚠

**6. Outer Cab Corner Patch Panel 1941-46**

**598671B ..... 36-46**  
Stamped. Outer right and left, rear. 16.587 -0.15  
..... **\$74.50 L&R** ⚠

**7. Side Splash Aprons 1940-46**

**3654023L ..... 40-46**  
Fabricated. Left-1/2T. 8.228 -0.15  
..... **\$35.00 EA** ⚠

**3654024R ..... 40-46**  
Fabricated. Right-1/2T. 8.228 -0.15  
..... **\$35.00 EA** ⚠

**3654025L ..... 40-46**  
Fabricated. Left-3/4T. 8.228 -0.15  
..... **\$55.00 EA** ⚠

**3654026R ..... 40-46**  
Fabricated. Right-3/4T. 8.228 -0.15  
..... **\$55.00 EA** ⚠

**8. Rear Pan 1941-46**

**3658265P ..... 41-46**  
Steel pan. Rear with license plate recess. Replaces back bumper for smooth look. 7.831 -0.15  
..... **\$167.25 EA** ⚠

**3658265PS ..... 41-46**  
Steel roll pan. Rear without license plate recess. Replaces back bumper for smooth look. 7.831 -0.15  
..... **\$128.25 EA** ⚠





**1947-55 PARTS**

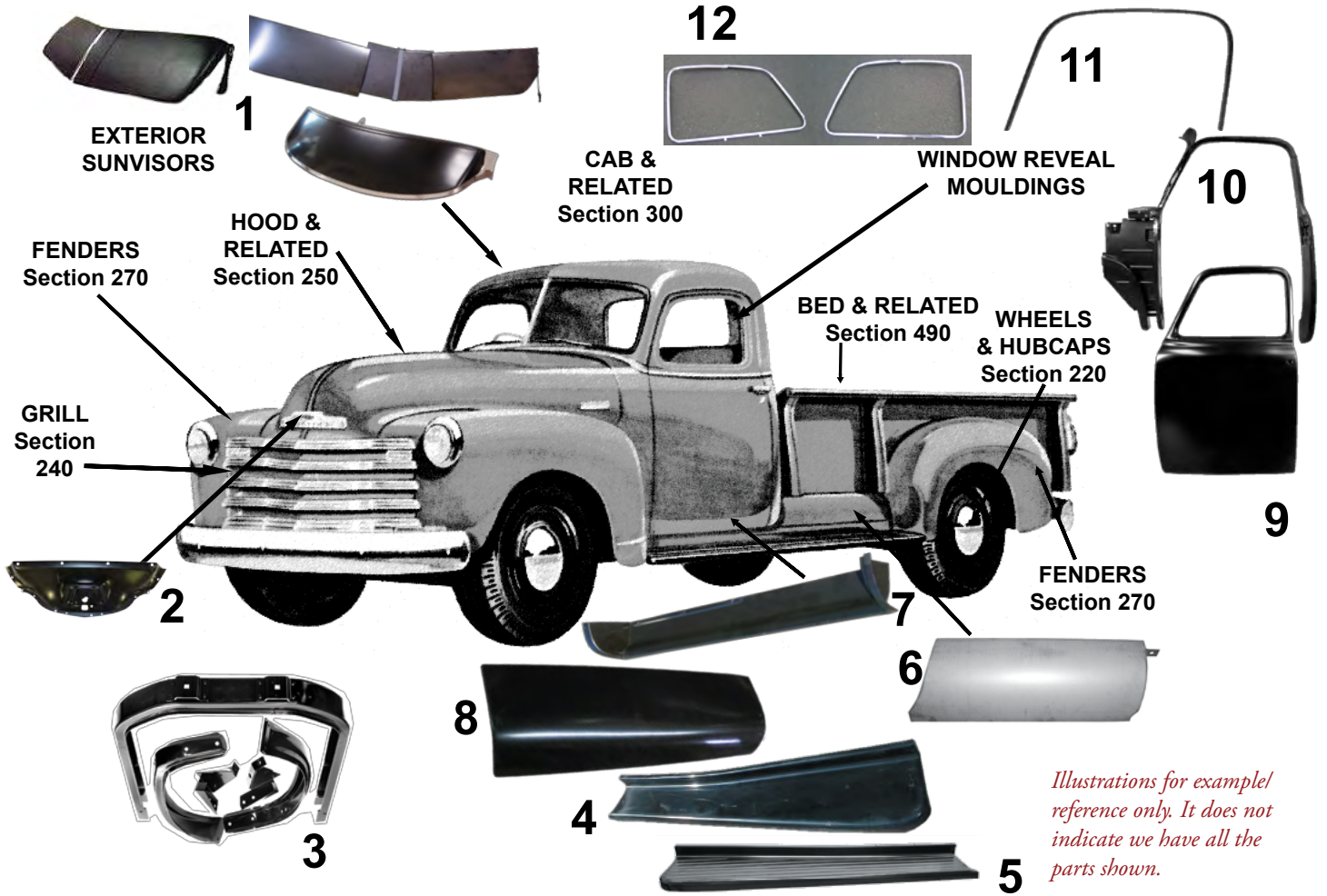

*Illustrations for example/ reference only. It does not indicate we have all the parts shown.*

- 1. Exterior Sunvisor**  
**986877**.....**47-53**  
 Truck. Accessory. Exterior Sunvisor. 10.201-0.15  
 ..... **\$325.00 EA** ⚠  
**986878S** ..... **54-55**  
 Steel reproduction with mounting hardware & instructions. Fits Chevy & GMC trucks. 10.201-0.15  
 ..... **\$477.50 EA** ⚠  
**2. Hood Latch Lower Assembly**  
**3682709C** .....**47-53**  
 Hood latch assembly fits above grille. Chrome. Includes latch. Chevrolet Only, will not fit GMC. 8.080-0.15  
 ..... **\$254.25 EA** ⚠  
**3682709P** .....**47-53**  
 Hood latch assembly fits above grille, black. Includes latch. Chevrolet Only, will not fit GMC. 8.080-0.15  
 ..... **\$152.00 EA** ⚠

- 2. Hood Latch Lower Assembly GMC**  
**2228975** .....**47-53**  
 Hood latch assembly fits above Grille. Includes latch. Fits GMC. 6.079-0.15  
 ..... **\$179.50 EA** ⚠  
**3. Radiator Core Support**  
**3707011**.....**47-55**  
 For center fill radiator. 1.270-0.15  
 ..... **\$371.25 EA** ⚠  
**4. Running Boards w/ Built-in Mounting Points (Fiberglass)**  
**3682721S**.....**47-54**  
 Fiberglass-smooth 1/2T. 8.299-0.15  
 ..... **\$575.00 PR** ⚠  
**3682721W**.....**47-54**  
 Fiberglass-smooth 1/2T (2in. wider). 8.299-0.15  
 ..... **\$586.25 PR** ⚠

- 5. Running Boards w/ Built-in Mounting Points (Steel)**  
**3687271** .....**47-54**  
 Steel (super repro) 1/2Ton. Ribbed. 8.299-0.15  
 ..... **\$525.50 PR** ⚠  
**3687271S** .....**47-54**  
 Fabricated. Smooth 16ga.cold rolled steel. 1/2Ton. 8.299-0.15  
 ..... **\$700.50 PR** ⚠  
**3687271SC** .....**47-54**  
 Chrome, ribbed steel. 1/2Ton. 8.299-0.15  
 ..... **\$600.50 PR** ⚠  
**3687271SW**.....**47-54**  
 Fabricated. Smooth 16ga.cold rolled steel. 1/2Ton (2 in. wider). 8.299-0.15  
 ..... **\$719.00 PR** ⚠  
**6. Side Splash Apron**  
**3676427L**.....**47-53**  
 Stamped. Left-1/2Ton. 8.228-0.15  
 ..... **\$32.00 EA** ⚠  
**3676428R** .....**47-53**  
 Stamped. Right-1/2Ton. 8.228-0.15  
 ..... **\$32.00 EA** ⚠



Chemicals shipped domestic ground only (Lower 48 states only). No international shipping.

**Phone: (360) 816-0211 • (800) 999-CHEV (2438) • [www.chevsofthe40s.com](http://www.chevsofthe40s.com)**

**6. Side Splash Apron, cont.**

- 3676429L** .....47-53  
Stamped. Left -3/4Ton. 8.228 -0.15  
..... **\$38.25 EA** ⚠
- 3676430R** .....47-53  
Stamped. Right -3/4Ton. 8.228 -0.15  
..... **\$38.25 EA** ⚠
- 3700361L** ..... 54  
Stamped. Left-1/2Ton. 8.228 -0.15  
..... **\$38.00 EA** ⚠
- 3700362R** ..... 54  
Stamped. Right -1/2Ton. 8.228 -0.15  
..... **\$38.00 EA** ⚠
- 3700365L** ..... 54  
Stamped. Left -3/4Ton. 8.228 -0.15  
..... **\$42.00 EA** ⚠
- 3700366R** ..... 54  
Stamped. Right -3/4Ton. 8.228 -0.15  
..... **\$42.00 EA** ⚠

**7. Door Patch Panel (Inner)**

- 3684147DL** .....47-54  
Stamped. Inner bottom, left (superior).  
16.150 -0.15  
..... **\$52.75 EA** ⚠
- 3684147DR** .....47-54  
Stamped. Inner bottom, right (superior).  
16.150 -0.15  
..... **\$52.75 EA** ⚠

**8. Door Patch Panel (Outer)**

- 3684147BL** .....47-54  
Stamped. Outer bottom left (superior).  
16.150 -0.15  
..... **\$46.25 EA** ⚠
- 3684147BR** .....47-54  
Stamped. Outer bottom right (superior).  
16.150 -0.15  
..... **\$46.25 EA** ⚠

**9. Metal Door**

- 3684147** .....47-50  
Steel door. Left side minus trim &  
hardware. EDP black finish. Exc COE.  
16.150 -0.15  
..... **\$499.00 EA** ⚠
- 3684148** .....47-50  
Steel door. Right side minus trim &  
hardware. EDP black finish. Exc COE.  
16.150 -0.15  
..... **\$499.00 EA** ⚠
- 3810915** ..... 52-55  
Steel door. Left side minus trim &  
hardware. EDP black finish. Exc COE.  
16.150 -0.15  
..... **\$498.50 EA** ⚠
- 3810916** ..... 52-55  
Steel. Right side minus trim & hardware.  
EDP black finish. Exc COE. 16.150 -0.15  
..... **\$499.25 EA** ⚠

**10. Door Pillar**

- 3807227B** .....47-53  
Outer, left side w/ side cowl panel &  
windshield frame. 16.578 -0.15  
..... **\$400.75 EA** ⚠
- 3807228B** .....47-53  
Outer, right side w/ side cowl panel &  
windshield frame. 16.578 -0.15  
..... **\$400.00 EA** ⚠

**11. Window Drip Rail**

- 3684289** .....47-54  
Left door. Window drip rail. 16.642 -0.15  
..... **\$46.50 EA** ⚠
- 3684290** .....47-54  
Right door. Window drip rail. 16.642 -0.15  
..... **\$45.00 EA** ⚠

**12. Window Reveal Mouldings**

- 3684847** .....47-54  
Left door, primered. 16.185 -0.15  
..... **\$55.25 EA** ⚠
- 3684847B** .....47-54  
Exterior chrome plated Stainless.  
16.185 -0.15  
..... **\$188.75 L&R** ⚠
- 3684848** .....47-54  
Right door, primered. 16.185 -0.15  
..... **\$55.25 EA** ⚠



**1947-54 PARTS**

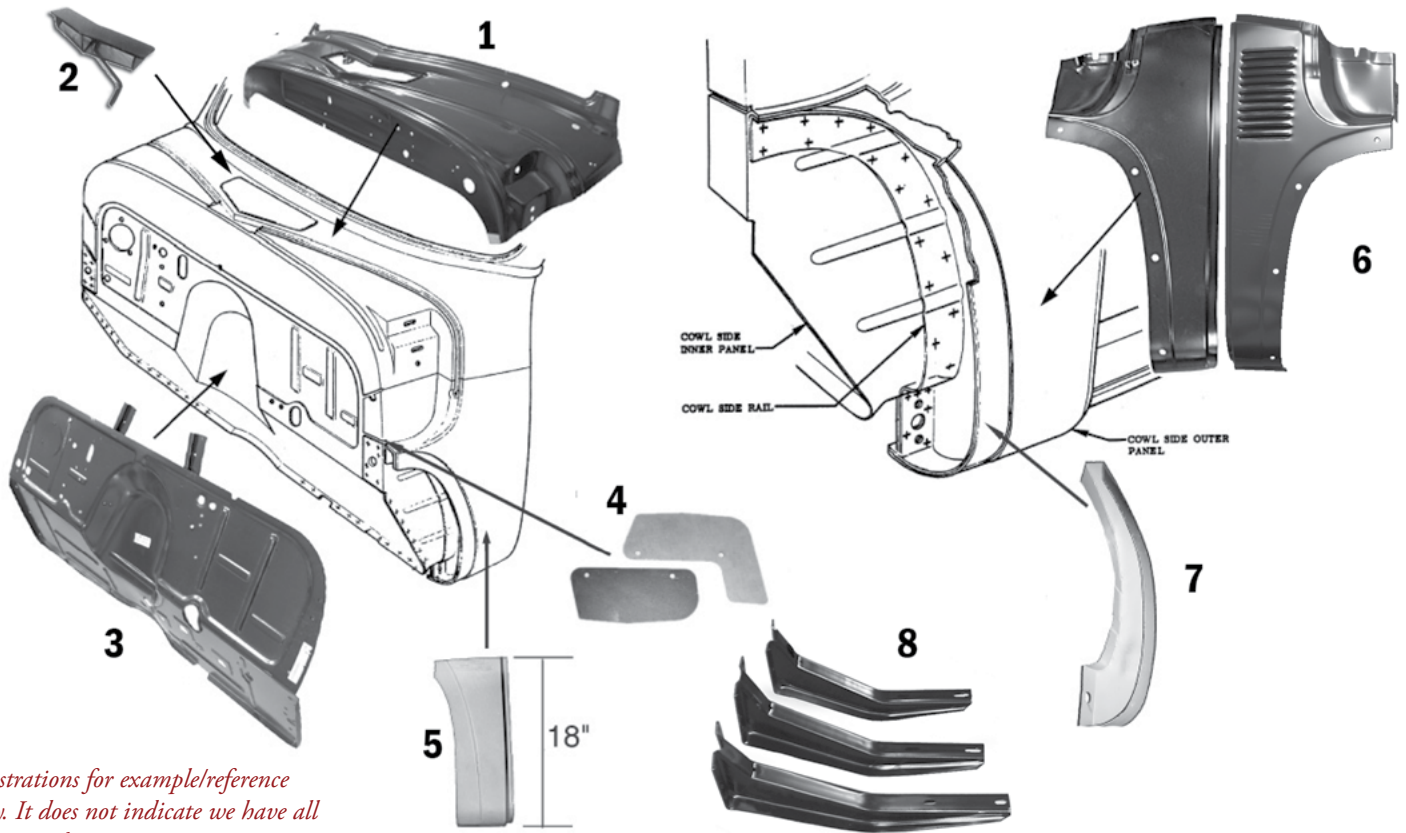

*Illustrations for example/reference only. It does not indicate we have all the parts shown.*

- 1. Upper Cowl Panel**  
**3696433A** .....47-53  
 Stamped. Nice quality panel. Full top of cowl. 16.551-0.15  
 ..... **\$278.00 EA** ⚠
- 2. Cowl Vent**  
**3682919** .....47-53  
 Assembly with handle. 16.125-0.15  
 ..... **\$135.75 EA** ⚠
- 3. Firewall (Steel)**  
**3696815A** .....47-54  
 Complete repro steel firewall. Excellent quality. EDP coated. Without heater holes. 16.551-0.15  
 ..... **\$285.50 EA** ⚠
- 4. Metal Filler Panel**  
**3685642** .....47-54  
 Firewall to inner panel. 8.155-0.15  
 ..... **\$12.50 PR** ⚠

- 5. Outer Cowl Patch Panel Fabricated**  
**3683002B** .....47-54  
 Fabricated. Lower-right. 16.551-0.15  
 ..... **\$54.00 EA** ⚠
- 3683003B** .....47-54  
 Fabricated. Lower-left. 16.551-0.15  
 ..... **\$54.00 EA** ⚠
- 6. Outer Cowl Patch Panel Stamped**  
**3683002SR** .....47-54  
 Stamped. Right-superior (w/ louvers). 31" height. 16.551-0.15  
 ..... **\$66.00 EA** ⚠
- 3683003SL** .....47-54  
 Stamped. Left-superior (no louvers). 31" height. Eliminates vent on 47-50. 16.551-0.15  
 ..... **\$66.00 EA** ⚠

- 7. Cab Front Lower Corner**  
**3684032** .....47-54  
 Fabricated. Arc-shaped firewall corners (behind tires) right. 16.551-0.15  
 ..... **\$60.50 EA** ⚠
- 3687291** .....47-54  
 Fabricated. Arc-shaped firewall corners (behind tires) left. 16.551-0.15  
 ..... **\$60.50 EA** ⚠
- 8. Running Board Brackets**  
**3683573B** .....47-55  
 Stamped. Left side. 7.016-0.15  
 ..... **\$149.50 SET** ⚠
- 3683574B** .....47-55  
 Stamped. Right side. 7.016-0.15  
 ..... **\$160.25 SET** ⚠



**1947-54 PARTS**

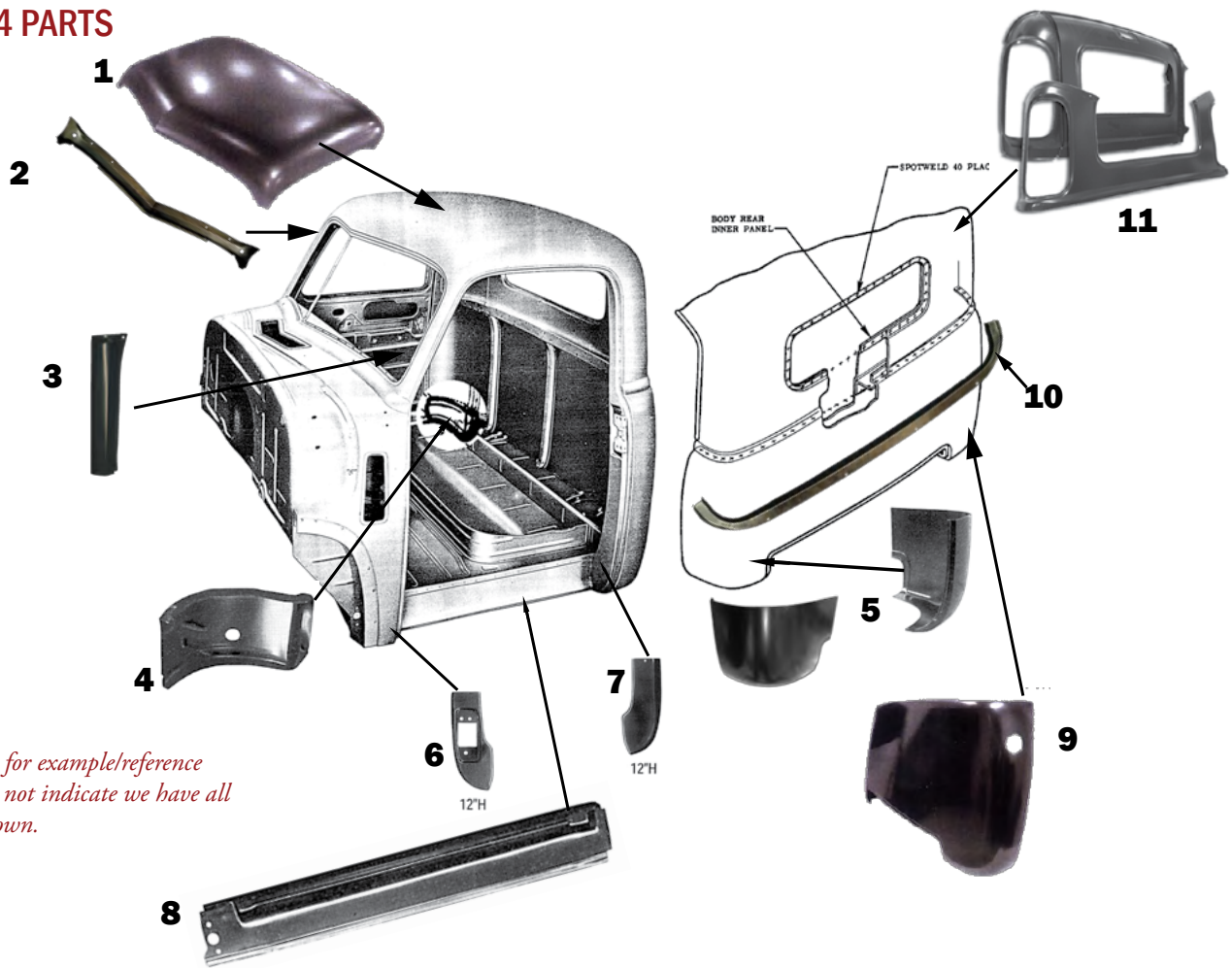

*Illustrations for example/reference only. It does not indicate we have all the parts shown.*

<b>1. Cab Roof</b>
<b>3693099A</b> .....47-53 Stamped metal replacement panel. 16.585 -0.15 ..... <b>\$335.25 EA</b> ⚠
<b>2. Windshield Upper Roof Panel Brace</b>
<b>3809231</b> .....47-53 Die stamped, Coated with weld-thru primer. 16.553 -0.15 ..... <b>\$65.00 EA</b> ⚠
<b>3. Windshield Pillar Panel</b>
<b>3807227L</b> .....47-53 Stamped. Left side. 16.578 -0.15 ..... <b>\$30.00 EA</b> ⚠
<b>3807227R</b> .....47-53 Stamped. Right side. 16.578 -0.15 ..... <b>\$29.75 EA</b> ⚠
<b>4. Inner Cab Corner Patch Panel</b>
<b>3693002B</b> .....47-54 Stamped. Inner right. 16.587 -0.15 ..... <b>\$43.25 EA</b> ⚠
<b>3693003B</b> .....47-54 Stamped. Inner left. 16.587 -0.15 ..... <b>\$43.25 EA</b> ⚠

<b>5. Outer Cab Corner Patch Panel</b>
<b>3693002A</b> .....47-54 Stamped. Outer right. 16.587 -0.15 ..... <b>\$77.75 EA</b> ⚠
<b>3693003A</b> .....47-54 Stamped. Outer left, rear. 16.587 -0.15 ..... <b>\$77.75 EA</b> ⚠
<b>6. Lower Door Hinge Post</b>
<b>3700481</b> .....47-54 Stamped. Left. 16.603 -0.15 ..... <b>\$72.75 EA</b> ⚠
<b>3700482</b> .....47-54 Stamped. Right. 16.603 -0.15 ..... <b>\$72.75 EA</b> ⚠
<b>7. Lower Door Latch Post</b>
<b>3703551</b> .....47-54 Stamped. Left. 16.163 -0.15 ..... <b>\$64.50 EA</b> ⚠
<b>3703552</b> .....47-54 Stamped. Right. 16.603 -0.15 ..... <b>\$64.50 EA</b> ⚠

<b>8. Outer Rocker Panel</b>
<b>3692809S</b> .....47-54 Stamped. Left (superior). 16.603 -0.15 ..... <b>\$60.25 EA</b> ⚠
<b>3692810S</b> .....47-54 Stamped. Right (superior). 16.603 -0.15 ..... <b>\$60.25 EA</b> ⚠
<b>9. Lower Cab Back Panel</b>
<b>3693000</b> .....47-54 Stamped. Exterior panel below back window. 16.587 -0.15 ..... <b>\$399.00 EA</b> ⚠
<b>10. Lower Rear Cab Back Panel Crossmember</b>
<b>3693000R</b> .....47-54 Stamped. Cab Lower Rear Back Panel Crossmember. Mounts at beltline. 16.587 -0.15 ..... <b>\$57.50 EA</b> ⚠
<b>11. Upper Cab Back Panel</b>
<b>3693099</b> .....47-54 Stamped. Upper exterior panel for 5 window cabs. 16.585 -0.15 ..... <b>\$356.25 EA</b> ⚠
<b>3809365B</b> .....47-54 Stamped. Upper interior panel for 5 window cabs. 16.585 -0.15 ..... <b>\$338.25 EA</b> ⚠

Returns require a return authorization number—call first. • Product pricing & availability subject to change.

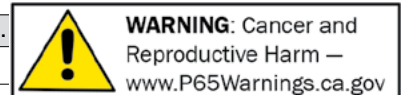

**1947-54 PARTS**

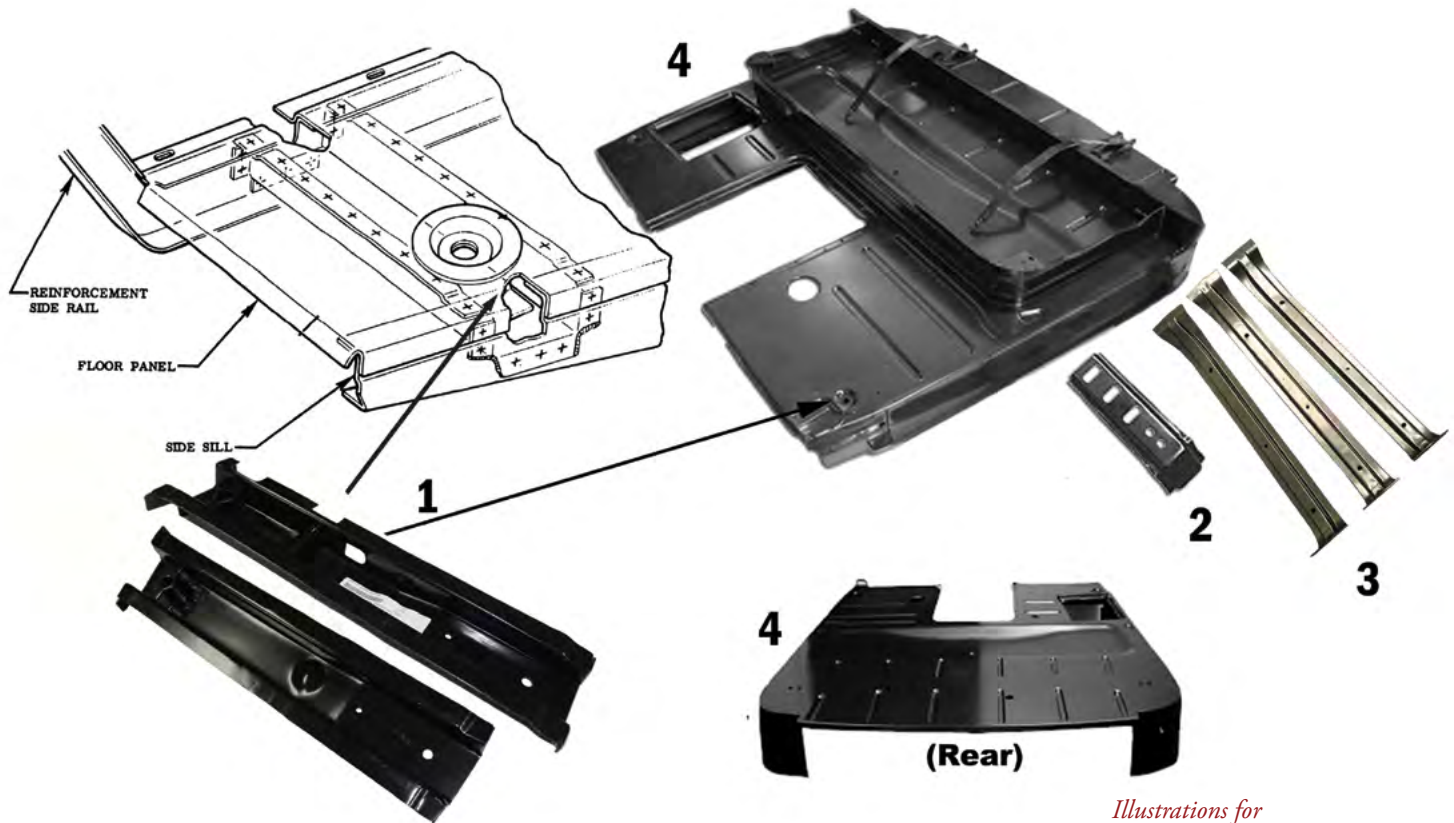

*Illustrations for example/reference only. It does not indicate we have all the parts shown.*

**1. Front Cab Mount brace**

- 3809493S** .....47-54  
Front left-die stamped (superior).  
16.545 -0.15  
..... **\$41.25 EA** ⚠
- 3809494S** .....47-54  
Front right-die stamped (superior).  
16.545 -0.15  
..... **\$41.25 EA** ⚠

**2. Rear Cab Mount Brace**

- 3809495** .....47-54  
Stamped. Connects cross brace.  
16.545 -0.15  
..... **\$41.75 EA** ⚠
- 3809496** .....47-54  
Stamped. Connects cross brace  
16.545 -0.15  
..... **\$41.75 EA** ⚠

**3. Cab Back Panel Supports**

- 3693000S** .....47-54  
Stamped. 3 pieces. 16.587 -0.15  
..... **\$61.75 SET** ⚠

**4. Floor Pan**

- 3713907A** .....47-54  
Stamped. with braces. 16.000 -0.15  
..... **\$550.75 EA** ⚠
- 3713907AC** .....47-54  
Complete Metal Floor Pan w/ tank straps,  
seat riser and floor braces. Excellent  
quality. 16.000 -0.15  
..... **\$624.25 EA** ⚠

**1947-54 PARTS**

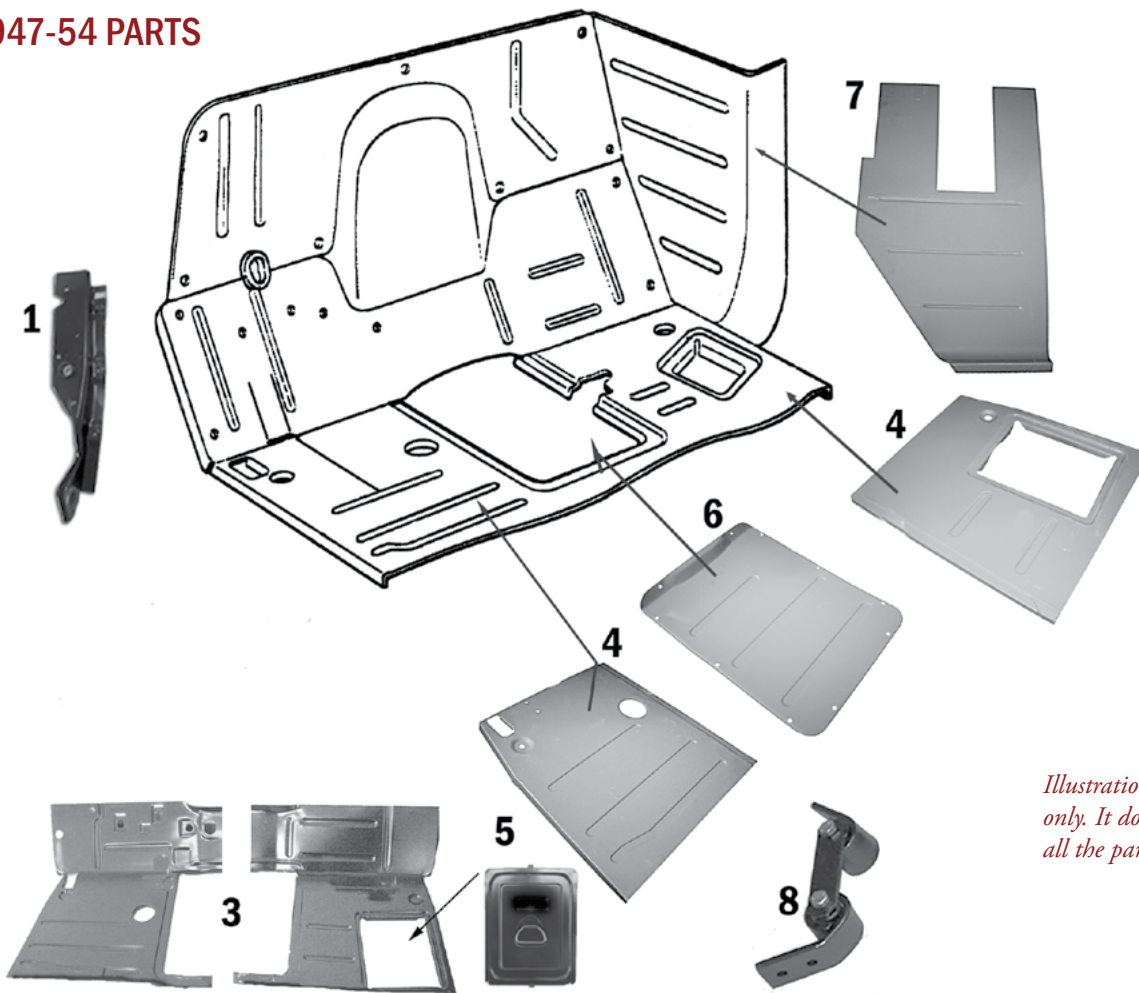

*Illustrations for example/reference only. It does not indicate we have all the parts shown.*

**1. Emergency Brake Bracket**

**3687303** ..... **48-55**  
For foot operated pedal. 4.648 -0.15  
..... **\$49.50 EA** ⚠

**2. Toe Board**

**3700191A** ..... **47-55**  
Die-stamped. Floor to firewall. 16.230 -0.15  
..... **\$146.25 EA** ⚠

**3. Floor Panel (From Seat Forward) W/ Toe Board**

**3701601LC** ..... **47-54**  
Stamped. Complete with toe board left.  
16.545 -0.2  
..... **\$152.50 EA** ⚠  
**3701601RC** ..... **47-54**  
Stamped. Complete with toe board right.  
16.545 -0.2  
..... **\$152.50 EA** ⚠

**5. Battery Cover**

**4754BD** ..... **47-53**  
Battery access delete panel. -0  
..... **\$40.00 EA** ⚠  
**3683383** ..... **47-54**  
Mounts in floor. 16.547 -0.15  
..... **\$64.00 EA** ⚠

**6. Floor Insert Over Transmission**

**3682939** ..... **47-55**  
Stamped. Metal 3 speed. 16.547 -0  
..... **\$52.00 EA** ⚠  
**3697607** ..... **47-55**  
4 speed. 16.547 -0.15  
..... **\$74.75 EA** ⚠  
**3697607F** ..... **47-55**  
Stamped. Fiberglass 4 speed. 16.547 -0.15  
..... **\$63.50 EA** ⚠

**7. Kick Panel (Metal Repair Panel)**

**3693495** ..... **47-50**  
Stamped. Inner left. 16.551 -0.15  
..... **\$44.00 EA** ⚠  
**3809358** ..... **47-54**  
Stamped. Kick Panel-Metal Repair Panel.  
Inner right. 16.551 -0.15  
..... **\$31.25 EA** ⚠  
**3684403** ..... **47-55**  
Heater delete cowl plate 16.551 -0.15  
..... **\$20.25 EA** ⚠  
**3696023** ..... **51-54**  
Stamped. Inner left. 16.551 -0.15  
..... **\$32.00 EA** ⚠

**8. Cab Mount Shackles & Brackets**

**53CABFRNTL** ..... **47-54**  
Cab mounting bracket, front left 7.330 -0.15  
..... **\$60.75 EA** ⚠  
**53CABFRNTR** ..... **47-54**  
Cab mounting bracket, front right  
7.330 -0.15  
..... **\$60.75 EA** ⚠  
**53CABREAR** ..... **47-54**  
Shackle assembly, cab mount 9.009 -0.15  
..... **\$266.25 L&R** ⚠



**FABRICATED SHEET METAL PARTS**



*Illustrations for example/reference only. It does not indicate we have all the parts shown.*

**1. Recessed Firewall (Steel)**

**3693009S54** .....47-54  
Kit w/ set back. Smooth for V8. Use with front floor kit #3686335b54 or stock floor. 16.545 -0.15

..... **\$433.25 EA** ⚠

**3693009SC** .....47-54  
Kit w/ set back. Smooth curved for V8. 16.545 -0.15

..... **\$450.50 EA** ⚠

**Smooth Firewall Bead Rolled**



**4754DD** .....47-54  
These 1947-1954 Firewall Filler Panels are designed to be easily installed by the DIY or a professional. The panels are laser cut from 18 gauge steel and then bead rolled to give a clean and custom look.

\*This is sold as a set (2 panels total) -0  
..... **\$140.00 EA** ⚠

**Smooth Firewall Bead Rolled, cont.**

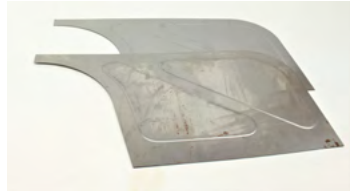

**4754HY** .....47-54

These 1947-1954 Firewall Filler Panels are designed to be easily installed by the DIY or a professional. The panels are laser cut from 18 gauge steel and then bead rolled to give a clean and custom look.

\*This is sold as a set (2 panels total) -0  
..... **\$140.00 EA** ⚠



**4754KA** .....47-54

2 panels. Firewall Filler Panels are designed to be easily installed by the DIY or a professional. The Firewall Panels are laser cut from 18 gauge steel 1.000 -0  
..... **\$140.00 EA** ⚠

**Smooth Firewall Bead Rolled, cont.**



**4754TR** .....47-54

2 panels. Firewall Filler Panels are designed to be easily installed by the DIY or a professional. The Firewall Panels are laser cut from 18 gauge steel 1.000 -0  
..... **\$140.00 EA** ⚠

**2. Radiator Core Support**

**3684764** .....47-53

For Chevy Trucks. Allows you to adjust your radiator up and down, side to side to get the fit you want. The radiator can be mounted up to 2-1/4" lower than stock which will allow the use of an engine mounted fan. 16.545 -0.15

..... **\$419.00 KIT** ⚠

**3684764B** ..... 54-55

For Chevy Trucks. Allows you to adjust your radiator up and down, side to side to get the fit you want. The radiator can be mounted up to 2-1/4" lower than stock which will allow the use of an engine mounted fan. 16.545 -0.15

..... **\$360.00 EA** ⚠

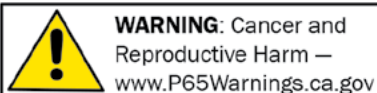

Chemicals shipped domestic ground only (Lower 48 states only). No international shipping.

**Phone: (360) 816-0211 • (800) 999-CHEV (2438) • www.chevsofthe40s.com**

**3. Cowl Vent Filler Panel**

**3683004A53** .....**47-53**  
 Weld in panel to delete vent. 16.545 -0.15  
 ..... **\$24.00 EA** ⚠



**4754CF** .....**47-54**  
 Upper Cowl Filler finishes off your clean firewall look when paired with our Firewall Filler Panels. The piece is laser cut from 18 gauge steel and easily installed in the original recess. 1.000 -0 ..... **\$40.00 EA** ⚠

**3683004B54** ..... **54**  
 Weld in panel to delete vent. 16.545 -0.3  
 ..... **\$19.25 EA** ⚠

**4. Drivers Side Vent Filler Panel**

**3683001** .....**47-50**  
 Weld in panel to delete vent. 16.545 -0.15  
 ..... **\$24.00 EA** ⚠

**5. Inner Fender Apron Kit**

**3686239** .....**47-54**  
 Inner fender Apron Kit. Cleans look of engine bay. Bolt-in. Stock or Smooth firewalls/ core supports. Chevrolet Only 16.545 -0.15  
 ..... **\$415.00 SET** ⚠

**6. Floor Kit**

**3686335B54** .....**47-54**  
 Front floor panels with toe board. For use with direct sheetmetal firewall #3693009S54. 0.000 -0.15  
 ..... **\$314.75 SET** ⚠

**Toe Board Bead Rolled**



**4754TB** .....**47-54**  
 These Toe Boards give the ultimate custom and clean look to finish off the engine bay. The Toe Boards are laser cut from 18 gauge steel and are to be used as a replacement part for the original toe boards. All holes for pedals, wiring etc. will need to be cut by the installer. -0 ..... **\$200.00 SET** ⚠



**1954 & 2004 Half-tons — Justin Wilder**

 **WARNING:** Cancer and Reproductive Harm — [www.P65Warnings.ca.gov](http://www.P65Warnings.ca.gov)



**SECTION 300T  
RESTORATION PARTS**

**Cab Mount**



**3654239K** .....39-46  
Includes pads, blocks, springs & hardware.  
9.015 -0.15 ..... **\$79.75 SET** ⚠

**Cab Mount Body To Frame**



**3701322B** .....47-54  
Pads & bolts. 9.015 -0.15 ..... **\$33.00 SET**  
⚠

**Cab Mount Pads**

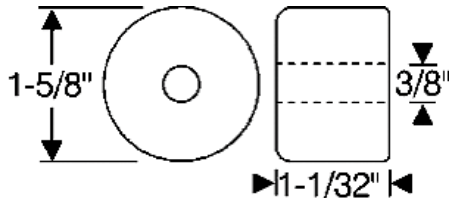

**3654239B** .....37-46  
At #4 bolt. 9.015 -0.15 ..... **\$53.75 PR** ⚠



**3654239** .....39-46  
w/ blocks & #4 bolt  
pads (1-7/8" dia. x  
1-5/8" thickness x 1/2"  
bolt hole). 9.015 -0.15  
..... **\$37.75 SET** ⚠



**3701322** .....47-54  
Front 9.023 -0.2  
..... **\$5.00 SET** ⚠

**Cab Mount Wood Blocks**



**476534B** .....39-40  
Pair 9.015 -0.15 ..... **\$8.00 PR** ⚠

**Body Mount Pads**



**3685018A** .....47-54  
Panel or Suburban. 9.009 -0.15 .....  
**\$15.00 SET** ⚠

**Cab Mount Rear**



**3660540** .....47-54  
Rubber bushings (8 pcs). 7.524 -0.3 .....  
**\$18.75 SET** ⚠

**Cab Mount Bolt Set**



**3654239A** .....37-40  
Complete set 9.015 -0.3 ..... **\$14.00 SET** ⚠  
**3654239A** ..... 41-46  
Complete set 9.015 -0  
..... **\$27.00 SET** ⚠



**3701322C** .....47-54  
Front 9.008 -0.3  
..... **\$4.50 SET** ⚠



**3701322S** .....47-54  
Complete cab mount bolt kit. 9.008 -0.15  
..... **\$48.50 SET** ⚠

**Cab Mount Shims**



**366982** .....ALL  
1/16in. shims (1-3/4in. x 1-1/8in. with  
1/2in. slot) (6 pcs). 9.023 -0.4 .....  
**\$3.59 SET** ⚠



**366983** .....ALL  
1/8in. shims (1-3/4in. x 1-1/8in. with  
1/2in. slot) (6 pcs). 9.023 -0.3 .....  
**\$3.49 SET** ⚠



**366984** .....ALL  
1/16in. shims (1-1/4in.  
x 1-1/8in. with 3/8in.  
slot) (6 pcs). 9.023 -0.4  
..... **\$3.75 SET** ⚠



**366985** .....ALL  
1/8in. shims (1-1/4in.  
x 1-1/8in. with 3/8in.  
slot) (6 pcs). 9.023 -0.4  
..... **\$4.00 SET** ⚠

**Cab & Bed Bolt Kits**

**BODYBOLTB** ..... 41-46  
Cab & Short Bed. Indented Hex Head  
Stainless Steel hardware kit. Complete  
headlight to taillight (Exc. cab and bed  
mount bolts.) 9.008 -0.15  
..... **\$355.50 SET** ⚠

**BODYBOLTB** .....47-51  
Cab & Short Bed. Indented Hex Head  
Stainless Steel hardware kit. 9.008 -0.15  
..... **\$438.00 SET** ⚠

**BODYBOLTB** ..... 52-53  
Cab & Short Bed. Indented Hex Head  
Stainless Steel hardware kit. 9.008 -0.15  
..... **\$430.00 SET** ⚠

**BODYBOLTB** ..... 54-55  
Cab & Short Bed. Indented Hex Head  
Stainless Steel hardware kit. 54-55 (1st  
Series). 9.008 -0.15  
..... **\$472.75 SET** ⚠

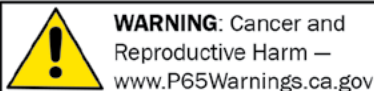

**WARNING:** Cancer and  
Reproductive Harm —  
www.P65Warnings.ca.gov

Chemicals shipped domestic ground only (Lower 48 states only). No international shipping.

**Phone: (360) 816-0211 • (800) 999-CHEV (2438) • www.chevsofthe40s.com**

## Cab Bolt Kits

### **BODYBOLT ..... 41-46**

Cab only. Indented Hex Head Stainless Steel hardware kit. 9.008 -0.15

..... **\$234.25 SET** ⚠

### **BODYBOLT ..... 47-51**

Cab only. Indented Hex Head Stainless Steel hardware kit. 9.008 -0.15

..... **\$250.25 SET** ⚠

### **BODYBOLTP ..... 47-51**

Panel. Indented Hex Head Stainless Steel hardware kit. 9.008 -0.15

..... **\$465.25 SET** ⚠

### **BODYBOLT ..... 52-53**

Cab only. Indented Hex Head Stainless Steel hardware kit. 9.008 -0.15

..... **\$247.25 SET** ⚠

### **BODYBOLTP ..... 52-53**

Panel. Indented Hex Head Stainless Steel hardware kit. 9.008 -0.15

..... **\$426.00 SET** ⚠

### **BODYBOLT ..... 54-55**

Cab only. Indented Hex Head Stainless Steel hardware kit. 54-55 (1st Series). 9.008 -0.15

..... **\$215.00 SET** ⚠

### **BODYBOLTP ..... 54-55**

Panel. Indented Hex Head Stainless Steel hardware kit. 54-55 (1st Series). 9.008 -0.15

..... **\$423.00 SET** ⚠



COE — Rick Michael



**SECTION 310T  
STREET ROD PARTS**

**Polyurethane Firewall Pad w/  
Insulation**



**3693007** ..... **37-46**  
Truck 16.802 -0.15 ..... **\$242.50 EA** ⚠



**3693009** ..... **47-54**  
Truck 16.802 -0.15 ..... **\$227.50 EA** ⚠

**3702869** ..... **47-54**  
Truck, No holes. 16.802 -0.15  
..... **\$205.50 EA** ⚠



**3693009B** ..... **47-54**  
Truck, fits Street Rod-style firewall  
#3693009S54. 16.802 -0.15 .....  
**\$229.00 EA** ⚠

**Insulation**



**3693008A** ..... **ALL**  
Jute w/ foil on 1 side  
(4 ft wide). Sold by the  
foot. 16.802 -0.15  
..... **\$9.50 FT** ⚠



**3693008B** ..... **ALL**  
Jute w/ foil on 2 sides  
(4 ft wide). Sold by the  
foot. 16.802 -0.15  
..... **\$13.00 FT** ⚠

**SECTION 310T  
RESTORATION PARTS**

**Fiber Board Firewall Pad w/  
Insulation**

Oversize shipping charges apply. Please call  
for rates.



**3687451** ..... **47-50**  
Firewall Pad with insulation and fiber  
board cover.  
This item is oversized, extra shipping  
charges will apply. 16.802 -0 **CALL** ⚠

**Metal Clips**



**3692752** ..... **47-54**  
Firewall pad 1-5/16 in.  
long (3 pcs). 15.282 -0.15

..... **\$11.00 SET** ⚠



**3692753** ..... **47-54**  
Firewall pad 1-1/2 in.  
long (3 pcs). 15.282 -0

..... **\$10.50 SET** ⚠

**Firewall Grommets**



**357507** ..... **29-46**  
Steering column at floor  
(exc COE). 6.758 -0.15

..... **\$52.00 EA** ⚠



**3681071** ..... **32-46**  
Throttle, choke, oil,  
temperature 3-7/8 in.  
long, 4 holes. 9.775 -0.15

..... **\$10.00 EA** ⚠



**3681096** ..... **33-46**  
Ignition armored coil  
cable. 9.775 -0

..... **\$8.00 EA** ⚠



**3673139** ..... **36-54**  
Vacuum hose. 9.775 -0

..... **\$1.75 EA** ⚠



**3653762A** ..... **39-53**  
Main wiring harness.  
9.775 -0

..... **\$4.00 EA** ⚠

**Firewall Grommets, cont.**



**874420A** ..... **39-53**  
Speedometer cable  
with 3 holes- use with  
windshield washer.  
9.775 -0.15

..... **\$6.39 EA** ⚠



**875520** ..... **39-53**  
Speedometer cable.  
9.775 -0.4

..... **\$2.75 EA** ⚠



**3684771** ..... **47-49**  
4 holes. 9.775 -0.3

..... **\$5.00 EA** ⚠



**3685928** ..... **47-54**  
Steering column with  
metal core & sponge  
seal #3682871 at  
firewall (floor shift).

Chevy & GMC 6.758 -0.15

..... **\$14.75 EA** ⚠



**3685928A** ..... **47-54**  
Steering column without  
metal core at firewall  
(floor shift). Chevy &  
GMC 6.758 -0.15

..... **\$45.00 EA** ⚠

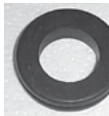

**3691292A** ..... **47-54**  
Grommet for 5/8 in.  
heater hose (thru  
firewall). 8.846 -0

..... **\$6.25 PR** ⚠



**3687205** ..... **48-54**  
Steering column  
grommet with metal  
core & sponge seal  
#3687204 at firewall  
(column shift). 6.758 -0.15

..... **\$13.50 EA** ⚠



**4805844** ..... **49-52**  
Rubber plug for 3/4 in.  
holes. 9.775 -0

..... **\$2.25 EA** ⚠



**3689044** ..... **50-52**  
4 holes. 9.775 -0.15

..... **\$17.50 EA** ⚠



**3711896** ..... **51-53**  
Wiring harness  
11/16in. diameter.  
9.775 -0

..... **\$4.49 EA** ⚠



**3695170** ..... **53-59**  
4 holes. 9.775 -0.15

..... **\$3.00 EA** ⚠

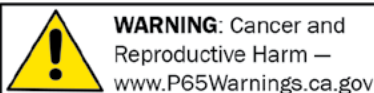

Chemicals shipped domestic ground only (Lower 48 states only). No international shipping.

**Phone: (360) 816-0211 • (800) 999-CHEV (2438) • www.chevsofthe40s.com**

## Section 310T: Firewalls, Firewall Pads & Firewall Grommets

### Firewall Grommets, cont.



**3653762B . . . . .54-59**  
Main wiring harness.  
9.775 -0.15  
..... **\$5.00 EA** ⚠

### Sponge Seal



**3682871 . . . . .47-54**  
Steering column at  
firewall (floor shift).  
6.758 -0.2  
..... **\$4.00 EA** ⚠



**3687204 . . . . .47-54**  
Sponge seal. Steering  
column at firewall  
(column shift). 6.758 -0.3

..... **\$6.00 EA** ⚠

### Screws



**3687205A . . . . .47-54**  
Stainless steel for  
steering column  
grommet. 6.758 -0.2  
..... **\$1.99 EA** ⚠

### Felt Floor Seal



**3657153 . . . . .41-46**  
Floor seal, floor felt for  
steering column, brake  
& clutch. 0.829 -0.15  
..... **\$7.50 EA** ⚠



Linda Mannon

Returns require a return authorization number—call first. • Product pricing & availability subject to change.



**WARNING:** Cancer and  
Reproductive Harm —  
[www.P65Warnings.ca.gov](http://www.P65Warnings.ca.gov)

**SECTION 320T  
STREET ROD PARTS**

**Sound Deadener/ Insulation Kit**

ACOUSTI-SHIELD KIT INCLUDES: FULLY ILLUSTRATED INSTRUCTIONS FOR A PAINLESS, TWO-HOUR INSTALLATION. STAGE 1: PRE-SIZED SOUND DAMPER PADS. The first stage consists of pre-trimmed, self adhesive, Sound Damper Pads. Bonded to strategically located trouble spots on the floor pan and roof of the vehicle to control body panel vibration and noise. These spots are mapped and labeled in detailed instructions which are included in the kit. STAGE 2: PRE-TRIMMED HEAT ABSORBER/BARRIER PANELS, SPRAY ADHESIVES AND SEALING TAPE. The second stage uses a high-tech absorbing, barrier material bonded to the body panels. Will deaden sound and insulate the vehicle from radiant heat penetration. Each absorber panel is cut to the correct shape and contour and is mapped and labeled in the detailed instructions.

1937-46 Chevrolet Truck



- 12927** ..... **37-46**  
Fits 1937-46 Truck. 15.492 -0.15  
**\$511.00 KIT** ⚠
- 12928** ..... **47-53**  
Fits 1947-53 Truck. 15.492 -0.15  
**\$565.00 KIT** ⚠
- 15894** ..... **47-53**  
Fits 1947-54 SUBURBAN. 15.492 -0.15  
**\$907.00 KIT** ⚠
- 15893** ..... **47-54**  
Fits 1947-54 Panel Truck. 15.492 -0.15  
**\$1,045.00 KIT** ⚠
- 15889** ..... **54-55**  
Fits 1954-55 (1st Series) trucks.  
15.492 -0.15  
**\$564.00 KIT** ⚠

**Body Deadener**



- 121126C** ..... **ALL**  
Hi-tech, 1/2 pound per square foot (3/16 in. x 3 ft x 8 ft). 15.492 -0.15  
**\$37.75 EA** ⚠

**Insulation**



- 3693008C** ..... **ALL**  
Foil tape for jute insulation (30 foot x 2 in. roll). 16.802 -0.15  
**\$12.00 EA** ⚠

**Jute Insulation Pad**



- 3693008** ..... **ALL**  
Floor mat (3 ft x 6 ft). 16.802 -0.15  
**\$31.25 EA** ⚠

**Web Adhesive Spray**



- SB-WEBAD** ..... **ALL**  
12 oz. can. Ideal for acoustic panel installation. An aggressive aerosol adhesive designed to be used with all lightweight cotton, fiberglass and Poly

Acoustic absorption panels.

Unlike other types of aerosol adhesive, SB-WEBAD does not atomize as it is applied. This means more material ends up on the surface to be treated and none left floating in the air. -0.15

- \$19.00 EA** ⚠

**Carpet With Pad**

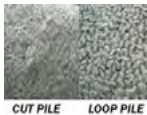

- 3716701C** ..... **37-46**  
Covers firewall to seat riser and side of seat riser. Specify Loop or Cut pile, Color and year of vehicle when ordering. 16.800 -0.15  
**\$342.75 EA** ⚠

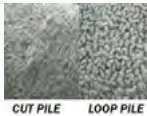

- 3698177C** ..... **47-53**  
Covers firewall to seat riser and side of seat riser. Specify Loop or Cut pile and Color when ordering. 16.800 -0.15  
**\$326.00 EA** ⚠

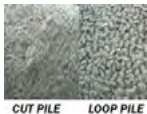

- 3716701C** ..... **54-55**  
Covers firewall to back of cab. Specify Loop or Cut pile and color when ordering. 16.800 -0.15  
**\$326.00 EA** ⚠

**SECTION 320T  
RESTORATION PARTS**

**Felt Body Deadener**



- 121126A** ..... **ALL**  
Original waffle pattern, used on door skins, roofs, etc (3/32in. x 3 ft x 8 ft). 15.492 -0  
**\$109.75 EA** ⚠



- 121126B** ..... **ALL**  
Original waffle pattern, used on door skins, roofs, etc (1/8in. x 3 ft x 8 ft). 15.492 -0  
**CALL** ⚠

**Jute Insulation Pad**



- 3698181** ..... **47-54**  
Floor mat (die cut). 16.800 -0.15  
**\$27.50 EA** ⚠

**Floor (Front) Mat**



- 3716701** ..... **37-46**  
Fits 37-40 w/ modification 16.800 -0.15  
**\$120.00 EA** ⚠



- 3698177A** ..... **47-54**  
Reproduction 16.800 -0.15  
**\$103.75 EA** ⚠

**Metal Plug**



- 594289B** ..... **ALL**  
Fits 1-1/2in. hole in floor over body mount bolts (2 pcs) 9.008 -0.3  
**\$7.89 PR** ⚠
- 594289C** ..... **ALL**  
Fits 3/4in. holes in floor (2 pcs) 9.008 -0.2  
**\$1.50 SET** ⚠

# Section 320T: Floorboard Parts, Seals, Sound Deadeners, Mats & Pedals

## Metal Plug, cont.

**594289D** ..... ALL  
Fits 1/2in. holes in floor (2 pcs) 9.008 -0.3

..... **\$1.69 PR** ⚠



**594289E** ..... ALL  
Fits 1-1/4in. hole (2 pcs) 9.008 -0.3

**\$7.29 PR** ⚠



**594289F** ..... ALL  
Fits 1" hole (2 pcs) 9.008 -0.4

**\$7.25 PR** ⚠

## Battery Cover



**354120** ..... 29-38  
Inspection cover in floor. 4-1/2" x 8"

16.547 -0.15 ..... **\$19.75 EA** ⚠

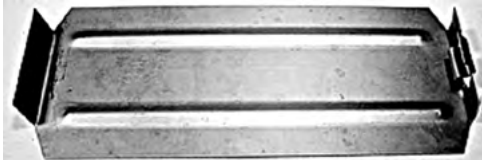

**3652966** ..... 39-46  
Inspection cover in floor. 4-1/2" x 10"

16.547 -0.15 ..... **\$25.00 EA** ⚠



**4754BD** ..... 47-53  
Battery access delete panel. -0

**\$40.00 EA** ⚠

## Floor Gasket

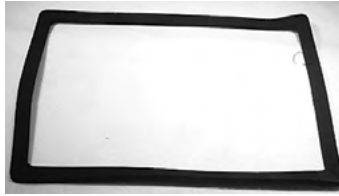

**3683383A** ..... 47-54  
Battery inspection cover. 16.547 -0.15

**\$6.00 EA** ⚠



**3697605** ..... 47-54  
For transmission cover in floorboard.

16.547 -0.15 ..... **\$5.00 SET** ⚠

## Screw, Bolts For Floorboard



**3693869B** ..... 39-46  
Floor and Toeboard. 21 pieces. 16.544 -0.15

..... **\$9.75 SET** ⚠



**187694B** ..... 41-46  
Bolt set for floor board (21 pcs). 16.542 -0.15

..... **\$8.75 SET** ⚠

## Bushing



**378431** ..... 37  
Gas pedal rod (in floor). 7/16 in. I.D. hole for rod.

2 in. O.D. mounting pad. 3.469 -0.15

..... **\$25.00 EA** ⚠

## Screws



**3652879** ..... 47-54  
For transmission cover in floorboard.

12.559 -0.15 ..... **\$4.00 SET** ⚠

## Gas Pedal



**3653533** ..... 37-40  
2-1/4 in. x 7-3/4 in.

3.451 -0 ..... **CALL** ⚠



**3681341A** ..... 42-46  
2-5/8 in. x 7-3/4 in. w/ pad. 3.451 -0.15

..... **\$29.75 EA** ⚠



**3682873** ..... 46-52  
2-7/8 in. x 8-1/16 in.

3.451 -0.15 ..... **\$14.00 EA** ⚠



**3701621** ..... 53-57  
2-7/8 in. x 8-1/16 in.

3.451 -0.15 ..... **\$16.00 EA** ⚠

## Floorshift Seal



**3653420** ..... 37-47  
Floor to transmission 3-speed.

Top: 2-3/4 in. O.D.  
Bottom: 2 in. O.D.

Inside Diameter: 1-1/4 in. 4.015 -0.15

..... **\$49.25 EA** ⚠



**3687200** ..... 37-54  
Floor to transmission 4-speed. 4.015 -0.15

..... **\$5.50 EA** ⚠

## Floor Shift Boot



**3651348A** ..... ALL  
Replacement-3 speed (uses #3654365T trim ring). 4.015 -0.3

..... **\$9.50 EA** ⚠

## Trim Ring



**3654365T** ..... ALL  
Stainless retains boot #3651348A. 4.044 -0.15

..... **\$13.25 EA** ⚠

## Hand Brake Seal



**3653418** ..... 40-54  
Sponge (under floor). 4.612 -0.2

..... **\$6.00 EA** ⚠

## Seal & Bumper



**3694124A** ..... 48-54  
Emergency pedal brake shaft. 4.612 -0.2

..... **\$5.00 SET** ⚠

## Emergency Pedal Boot



**3694124** ..... 48-54  
Under floor. 4.612 -0.15

..... **\$8.50 EA** ⚠



**3694125** ..... 48-54  
Metal retainer. 4.615 -0.15

..... **\$7.00 EA** ⚠



**594988A** ..... ALL  
Floor hand brake (not original) uses trim plate #595026 4.612 -0.3

..... **\$9.00 EA** ⚠

## Trim Plate



**595026** ..... ALL  
Stainless-retains boot #594988A 4.613 -0.15

..... **\$10.50 EA** ⚠

Returns require a return authorization number—call first. • Product pricing & availability subject to change.



**WARNING:** Cancer and Reproductive Harm — www.P65Warnings.ca.gov

**Floor Plug Master Cylinder**

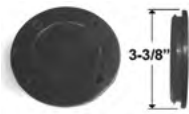

**592865.....36-54**  
Master cylinder inspection (in floor). 3-3/8 in. diameter for 3 in. hole. 12.541 -0.15

**\$8.00 EA** ⚠

**Starter Pedal**



**397577.....29-54**  
Foot starter rubber cap/button (black). 1/2" height, 2-1/16" dia. 2.004 -0.15

**\$16.00 EA** ⚠



**3654152.....37-54**  
Return spring. 2.029 -0

**\$3.99 EA** ⚠



**3654134.....38-54**  
Foot starter rubber button. 2" dia., 1-1/4" total height. 2.004 -0.3

**\$9.50 EA** ⚠



**3716711.....38-54**  
Rubber bellows. 2.014 -0.15

**\$6.25 EA** ⚠

**Pedal Pad**

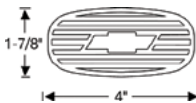

**364022.....29-46**  
Brake & clutch with bowtie. 4.630 -0

**\$40.00 PR** ⚠



**3683490.....47-59**  
Brake, clutch & emergency. 4.630 -0.3

**\$9.00 EA** ⚠

**Bumper**



**3681065.....37-46**  
Clutch pedal (under floor). 9.108 -0.15

**\$21.50 EA** ⚠



**3653388.....47-54**  
Brake & clutch arms to floor (2 pcs). 9.108 -0.4

**\$8.75 SET** ⚠

**Brake Pedal Return Spring**



**368244.....32-46**  
Clutch Pedal Return Spring. Overall Length 3-1/4". 4.827 -0.3

**\$6.50 EA** ⚠



**3698665.....47-57**  
Overall length 5-3/4in. 4.827 -0.3

**\$10.00 EA** ⚠

**Bushings**



**3682074.....37-46**  
Clutch & brake pedal shaft (13/16 in. O.D. x 3/4 in. I.D. x 1-25/64 in. long) 4.626 -0.15

**\$27.00 PR** ⚠



**3683016.....47-54**  
Clutch & Brake Pedal Shaft (1-1/16 in. O.D. X 1 in. I.D. X 1-1/4 in. Long) 0.831 -0.15

**\$20.00 PR** ⚠

**Seal**



**3657153.....41-46**  
Floor seal, floor felt for steering column, brake & clutch. 0.829 -0.15

**\$7.50 EA** ⚠

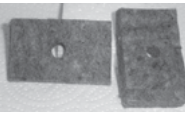

**594337.....47-51**  
Floor felt brake & clutch pedal (2 pcs). 0.829 -0.15

**\$6.00 SET** ⚠



**3658395B.....47-54**  
(felt) gas pedal rod in floor. 3.469 -0.15

**\$4.75 SET** ⚠



**594337A.....52-54**  
Floor felt brake & clutch pedal (2 pcs). 0.829 -0.15

**\$5.00 SET** ⚠

**Odds & Ends**

Please call for availability on all Odds & Ends parts; once part is sold, it may no longer be in stock.

**3672713U.....42**  
Gas pedal. Fits all COMM & UTIL. 2-5/8in. X7-7/8in. (Used) 3.451 -0.4

**\$20.00 EA** ⚠

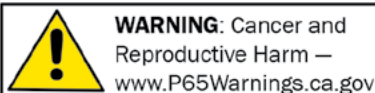

**WARNING:** Cancer and Reproductive Harm — [www.P65Warnings.ca.gov](http://www.P65Warnings.ca.gov)

Chemicals shipped domestic ground only (Lower 48 states only). No international shipping.

**Phone: (360) 816-0211 • (800) 999-CHEV (2438) • [www.chevsofthe40s.com](http://www.chevsofthe40s.com)**

# Section 330T: Interior, Sunvisors, Dome Lights, Headliners, Interior Screws, Door Panels, Kick Panels, Seats, Seat Covers & Belts

## SECTION 330T STREET ROD PARTS

### Seat Belts

**1001** .....ALL  
Lap belts available in black, burgundy, grey or tan (specify color when ordering). Comes with standard pushbutton release. 52" 14.875 -0.15  
..... **\$35.00 EA** ⚠

**2002** .....ALL  
2-point retractable lap only belts available in black, burgundy, grey or tan (specify color when ordering). Comes with standard pushbutton release. 14.875 -0.15  
..... **\$60.00 EA** ⚠



**SBELTA** .....ALL  
Aircraft style, chrome buckle lap belt. Choose color: Black, Dark Blue, Brown, Grey, Maroon, Red Wine, Red or Tan (hardware kit sold separately). 74" 14.875 -0  
..... **\$22.00 EA** ⚠

### Seat Belts, cont.



**SBELTGM** .....ALL  
GM push button, chrome/silver buckle lap belt. Choose color: Black, Blue, Grey, or Red (hardware kit sold separately). 74" 14.875 -0 ..... starting at **\$29.00 EA** ⚠

### Seat Belt Anchor Kit



**13245** .....ALL  
Hardware anchor kit for one complete seat belt. Includes 2 of each: bolts, washers, lock washers and nuts. 14.875 -0.2  
..... **\$4.00 SET** ⚠



**SBHP** .....ALL  
Deluxe reinforcing anchor plates. Reduces chance of floor damage on high belt loads. Kit for 1 belt. 14.875 -0.15  
..... **\$20.75 SET** ⚠



**SBHPA** .....ALL  
Angled anchor mounts for flat floor applications. Use with part #SBHP to complete your seat belt installation. Kit for 1 belt. 14.875 -0.15  
..... **\$16.00 SET** ⚠

### Headliner Conversion

**3808406C** .....**37-54**  
Napped Cotton Headliner conversion kit for Panel trucks and Suburbans. Any remnants of original headliner must be discarded. Conversion headliner is bow suspended much like vintage passenger cars. Hardware is included with kit. Bows are fitted to roof by installer (drilling over doors is required). Professional Installation is recommended. Specify color: taupe, dark taupe, maroon, beige, grey, ivory, light green, dark green, aqua, red, medium blue or black. 16.742 -0  
..... starting at **\$299.00 EA** ⚠

### Headliner Molded ABS Plastic

These are ABS Plastic with a medium embossed leather grain texture. This material is easily formed with heat and duplicates the original look and texture exactly. ABS plastic is very tough, yet flexible, and does not show scratches or scuffs. It can be easily dyed with a flat vinyl plastic spray paint. All of our patterns are based on out-of-vehicle originals. With few exceptions, truck headliners were black or brown when they came from the factory during the early years. ABS plastic can be easily dyed with a flat, vinyl plastic spray paint. The panels also can be covered with cloth or acoustic material.

### 1947-'55 Pretrimmed Panels

The panels and pieces below are model specific, designed for your truck. Finish them off by covering them with stretchable tweed, vinyl, ultraleather, ultrasuede or leather available from RodDoors. ⚠

#### The Eureka

Design: Ron Mangus  
**Door Panels** with built-in armrest ..... \$259 pr  
RD-3080  
**Kickpanels** ..... \$109 pr  
RD-3083  
**Headliners** ..... \$249 ea  
RD-3085 47-48 split window  
RD-3086 49-53 split window (smooth)  
RD-3087 54-55 round window (smooth)  
**Rear Cab Covers**  
RD-3090 47-48 no tank ..... \$275 ea  
RD-3091 49-55 no tank, Quinn design .. \$275 ea

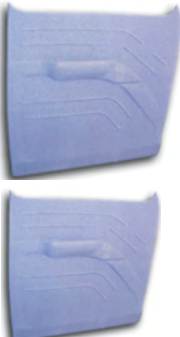

#### The Quinn

Design: Rich Santana  
**Door Panels** with optional arm rest  
RD-3242 w/o armrest ..... \$249 pr  
RD-3241 w/ armrest ..... \$275 pr  
**Door Panels** with optional deco shape  
RD-3240 with armrest ..... \$299 pr  
**Headliners** ..... \$299 ea  
RD-3088/RD-3089 47-48, 49-53  
**Gas Tank Cover** ..... \$275 ea  
RD-3092 Fits over stock gas tank. Built-in package tray and room to mount speakers.



Returns require a return authorization number—call first. • Product pricing & availability subject to change.

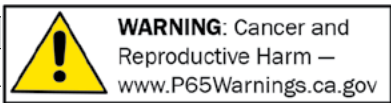



# Section 330T: Interior, Sunvisors, Dome Lights, Headliners, Interior Screws, Door Panels, Kick Panels, Seats, Seat Covers & Belts

## Headliner Molded ABS Plastic, cont.



**593125P** .....37-38  
Fits Chevy trucks (exc. Suburban).  
16.742 -0.15 ..... **\$246.50 EA** ⚠



**3654634P** .....39-46  
Fits Chevy trucks (exc. Panel & Suburban).  
16.742 -0.15

..... **\$246.50 EA** ⚠

**3676356P** .....47-53  
Fits Chevy trucks (exc. Suburban).  
Superior. 16.742 -0.15

..... **\$246.50 EA** ⚠

**3676357P** .....47-53  
Fits Chevy trucks (exc. Suburban).  
16.742 -0.15

..... **\$209.00 EA** ⚠



**3700527P** ..... 54  
Fits Chevy trucks (exc. Suburban). 16.742 -0.15

..... **\$209.00 EA** ⚠

## Sound & Vibration Damping

Note: Oversize shipping charges apply. Please call for rates.



**V-MAXAPP** .....**ALL**  
Application tool. Great tool to use when installing or forming damping material.

8.800 -0.15

..... **\$7.50 EA** ⚠



**VB-2** .....**ALL**  
Individual sheet. Thickness= .042". 37" X 54" 8.800 -0.15

..... **\$61.00 EA** ⚠



**VB-2HD** .....**ALL**  
HEAVY DUTY individual sheets. Thickness= .075". 37" X 54"

8.800 -0.15

..... **\$95.25 EA** ⚠

## Header Panel



**593369** .....36-38  
Mounts above windshield (fiberglass).  
16.562 -0.15 ..... **\$174.00 EA** ⚠



**598772** .....39-46  
Mounts above windshield (fiberglass).  
16.563 -0.15 ..... **\$174.00 EA** ⚠

## SECTION 330T RESTORATION PARTS

### Exterior Sunvisor

**986877P** .....37-53  
Visor - Exterior Steel Peckat Reproduction  
Fits 30s To Early 50s With Split W/S and Drip Rails -0 ..... **\$750.00 EA** ⚠



**986877** .....47-53  
Truck. Accessory. Exterior Sunvisor.  
10.201 -0.15 ..... **\$325.00 EA** ⚠



**986877FS** .....47-53  
Truck exterior visor. Metal, Fulton reproduction with mounting hardware & instructions. Adjustable. 10.201 -0.15 ..... **\$495.00 EA** ⚠

## Exterior Sunvisor, cont.



**986878S** .....54-55  
Steel reproduction with mounting hardware & instructions. Fits Chevy & GMC trucks. 10.201 -0.15 ..... **\$477.50 EA** ⚠

### Sunvisor



**3685637** .....47-53  
Left side interior visor with bracket, screws & template.

Choose color: Black, Brown or Grey.  
16.070 -0 .....starting at **\$45.00 EA** ⚠

**986155** .....47-53  
Right side interior visor with bracket, screws & template.

Choose color: Black, Brown or Grey.  
16.070 -0 .....starting at **\$45.00 EA** ⚠



**3685637B** .....47-59  
Interior visor. Brown. 16.070 -0.15 ..... **\$37.75 EA** ⚠

**3685637C** .....47-59  
Interior visor. Black. 16.070 -0.15 ..... **\$37.75 EA** ⚠

**3685637D** .....47-59  
Interior visor. Grey. 16.070 -0.15 ..... **\$34.00 EA** ⚠



**3703645** ..... 54  
Interior visor with bracket, screws & template. Left side, black, brown & Grey (specify color). 16.070 -0 .....starting at **\$45.00 EA** ⚠



**WARNING:** Cancer and Reproductive Harm — [www.P65Warnings.ca.gov](http://www.P65Warnings.ca.gov)

Chemicals shipped domestic ground only (Lower 48 states only). No international shipping.

Phone: (360) 816-0211 • (800) 999-CHEV (2438) • [www.chevsofthe40s.com](http://www.chevsofthe40s.com)

**Section 330T: Interior, Sunvisors, Dome Lights, Headliners, Interior Screws, Door Panels, Kick Panels, Seats, Seat Covers & Belts**

**Sunvisor, cont.**

**986773..... 54**  
Interior visor with bracket, screws & template. Right side, black, brown & Grey (specify color). 16.070 -0  
..... starting at **\$45.00 EA** ⚠️

**Sunvisor Components**



**985628A .....39-46**  
Interior visor Support (Right or Left Side)  
16.070 -0.15 ..... **\$29.75 EA** ⚠️



**3685637L .....47-53**  
Interior visor support bracket. Left side with screws & template. 16.070 -0.2  
**\$38.50 EA** ⚠️



**986155R .....47-53**  
Interior visor support bracket. Right side with screws & template. 16.070 -0.15  
**\$27.00 EA** ⚠️



**3685637EB .....47-59**  
Board only for interior visor. Fits Chevy & GMC. Fits left or right. 16.070 -0.15  
**\$20.75 EA** ⚠️



**3703645L ..... 54**  
Interior visor support. Left side with screws & template. 16.070 -0.15  
**\$24.75 EA** ⚠️



**986773R ..... 54**  
Interior visor support. Right with screws & template. 16.070 -0.15  
**\$24.75 EA** ⚠️

**Rear Sun Shade**



**985715T .....47-54**  
Rear window sun shade blinds. 11.204 -0.15  
..... **\$119.25 SET** ⚠️

**Clutch Head Driver**



**DRIVER .....ALL**  
Magnetic clutch head driver, Chevrs imprint. w/ 5 bits (1/8 in., 5/32 in., 3/16 in., 1/4 in., 5/16 in.) 8.821 -0  
**\$22.25 SET** ⚠️

**Clutch Head Socket Set**



**CHSS-4 .....ALL**  
4 pc. 3/8 Drive. Includes 5/16", 1/4", 3/16", 5/32" sockets. 8.821 -0.15  
**\$20.50 SET** ⚠️

**Headliner Bow**



**3807558 .....50-54**  
Center (52in. long). Paintable bare steel. 16.745 -0.15  
..... **\$37.75 EA** ⚠️

**Headliner Die Cut Cardboard**



**593125 .....37-38**  
1-piece. Choose Black, Brown or Grey. 16.742 -0.15  
..... starting at **\$45.00 EA** ⚠️

**Headliner Die Cut Cardboard, cont.**



**3801123 .....39-41**  
1-piece. Choose Black, Brown or Grey. 16.742 -0.4  
..... starting at **\$44.00 EA** ⚠️



**3654634 .....42-46**  
2-piece. Choose Black, Brown or Grey. 16.742 -0.15  
..... starting at **\$35.00 SET** ⚠️



**3694283 .....47-49**  
Black, Brown or Grey (specify color when ordering). 16.742 -0.15  
..... starting at **\$35.00 SET** ⚠️



**3676357 .....50-53**  
2-piece. Choose Black, Brown or Grey. 16.742 -0  
..... **\$35.00 SET** ⚠️

**3700527 ..... 54**  
2-piece. Choose Black, Brown or Grey. 16.742 -0.3  
..... **\$45.00 SET** ⚠️

**Headliner Washers**

**3654636 .....34-41**  
Rubber. Perfect repro. 16.747 -0.15  
..... **\$5.50 SET** ⚠️

**Interior Screws**

**3654597A .....37-50**  
8 x 32 x 1/2in. clutch head (100 pcs). 16.170 -0.15  
..... **\$30.00 SET** ⚠️

Returns require a return authorization number—call first. • Product pricing & availability subject to change.

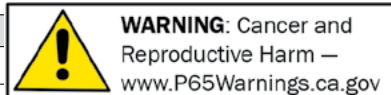

# Section 330T: Interior, Sunvisors, Dome Lights, Headliners, Interior Screws, Door Panels, Kick Panels, Seats, Seat Covers & Belts

## Interior Screws, cont.



**3654597C** .....37-50  
8 x 32 x 1/2in. clutch head (10 pcs). 16.170 -0

..... **\$3.00 SET** ⚠

## J-Nut Retainer



**0184001**.....37-46  
Front of headliner (5 pcs). 16.742 -0.4

..... **\$4.25 SET** ⚠

## Screw Set



**477366** .....41-46  
Headliner 8 x 32 x 1/2in. clutch head (22 pcs). 16.742 -0.3

..... **\$11.25 SET** ⚠



**3684161A**.....47-53  
Door panel, cardboard, does both doors (12 pcs). 16.290 -0.4

..... **\$3.00 SET** ⚠



**3654597B** .....47-54  
Headliner. 16.290 -0.4

..... **\$5.00 SET** ⚠



**3684481A** .....47-54  
Windshield garnish moulding (14 pcs). 16.290 -0.4

..... **\$3.50 SET** ⚠



**3684481B** .....47-54  
Window garnish mouldings, 2 doors.

16.290 -0.3

..... **\$6.00 SET** ⚠



**3694284B** .....47-54  
Headliner, door panel, window & windshield garnish mouldings.

16.290 -0.4

..... **\$17.50 KIT** ⚠

## Windshield Divider Moulding



**3684697B**...47-53  
Painted with upper & lower caps & fasteners.

16.018 -0.15

..... **\$23.50 SET** ⚠

## Windshield Divider Moulding, cont.



**3684697S**...47-53  
Interior. Stainless windshield division trim. 16.018 -0.15

..... **\$42.25 EA** ⚠

## Door Panel Fasteners



**WF18**.....ALL

This is a nail on panel repair clip for the interior door panel.

10.000 -0.3

..... **\$2.00 PR** ⚠

## Door Panel Metal Frames



**3686120** .....47-54  
Less clips. 16.166 -0.15

..... **\$27.25 PR** ⚠



**3686120S**.....47-54  
Polished stainless steel with clips. 16.166 -0.15

..... **\$42.00 PR** ⚠

## Kick Panels



**474791** .....36-38

Inner. Choose Black, Brown or Grey. Specify color when ordering.

16.700 -0.2

.....starting at **\$27.50 L&R** ⚠

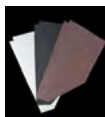

**609526**.....39-46

Inner. Choose Black, Brown or Grey. Specify color when ordering.

16.700 -0.15

.....starting at **\$15.00 L&R** ⚠



**609527**.....47-54

Inner. Choose Black, Brown or Grey (not original). Specify color when ordering.

16.700 -0.15

..... **\$12.00 L&R** ⚠

## Kick Panels Bead Rolled Steel

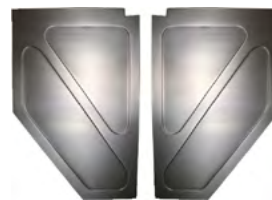

**4754KP**.....47-54

Kick Panels are made to install as a cover or can be used as a replacement part. The kick panels are laser cut from 18 gauge steel and can be fastened with screws, Velcro, welding or however the installer sees fit. -0

..... **\$140.00 L&R** ⚠

## Metal Frame Joint Clips



**3697673**.....47-54

Zinc 16.166 -0.2

..... **\$2.50 PR** ⚠



**3697673S**.....47-54

Polished Stainless

16.166 -0.15

..... **\$2.00 PR** ⚠

## Door Panels Bead Rolled Aluminum



**4754DP**.....47-54

Aluminum Door Panels are a replacement part for the original cardboard door panels. Made from 20 gauge aluminum these door panels mount with screws in the factory location. -0

..... **\$140.00 L&R** ⚠

## Door Panels Cardboard

**3700543** .....47-54

Choose Black, Brown or Grey. Specify color when ordering. 16.165 -0

.....starting at **\$25.75 L&R** ⚠



**3700543A** .....47-54

Original leather grain Black or Maroon. Specify color when ordering. 16.165 -0.4

..... starting at **\$18.00 L&R** ⚠



**WARNING:** Cancer and Reproductive Harm — [www.P65Warnings.ca.gov](http://www.P65Warnings.ca.gov)

Chemicals shipped domestic ground only (Lower 48 states only). No international shipping.

Phone: (360) 816-0211 • (800) 999-CHEV (2438) • [www.chevsofthe40s.com](http://www.chevsofthe40s.com)

# Section 330T: Interior, Sunvisors, Dome Lights, Headliners, Interior Screws, Door Panels, Kick Panels, Seats, Seat Covers & Belts

## Rear Cab Corners



**4754SB1.....47-54**  
Smooth with 6.5"  
speaker holes -0  
..... **\$480.00 EA** ⚠



**4754SB2.....47-54**  
Smooth with 6"x9"  
speaker holes -0  
..... **\$85.25 EA** ⚠



**4754SB3.....47-54**  
Bead rolled with 6.5"  
speaker holes -0  
..... **\$106.50 SET** ⚠



**4754SB4.....47-54**  
Bead rolled with 6"x9"  
speaker holes -0  
..... **\$106.50 EA** ⚠

## Rear Cab Panel



**4754BSP.....47-54**  
Behind seat panel. 18G  
raw steel, 3 pieces,  
bead rolled.  
-0  
..... **\$350.50 EA** ⚠

## Retainer Button



**3707152.....53-55**  
Door panel cardboard,  
use 12. 16.165-0.3  
..... **\$1.25 EA** ⚠

## Seat Cover

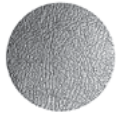

**593345.....37**  
W/ split seat bottom  
(brown). 16.715-0.15  
..... **\$175.00 EA** ⚠



**593345A.....37**  
W/ split seat bottom  
(black). 16.715-0.15  
..... **\$175.00 EA** ⚠

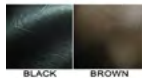

**3808199.....37-46**  
Black 16.715-0.4  
.....starting at **\$135.00 EA** ⚠



**3808200.....47-49**  
Matches repro door  
panels-black or  
brown(specify color  
when ordering). 16.715-0  
.....starting at **\$150.00 EA** ⚠

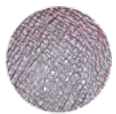

**3808201.....47-49**  
Original-maroon (specify  
year when ordering).  
16.715-0.15  
.....starting at **\$175.00 EA** ⚠

## Seat Cover, cont.



**3808205.....50-54**  
Original-black, brown or  
tan (specify color when  
ordering). 16.715-0.4  
.....starting at **\$175.00 EA** ⚠



**3808204.....54**  
Original (spanish grain  
brown). 16.715-0.15  
..... **\$178.75 EA** ⚠

## Upholstery Batting



**4092635B.....37-54**  
Cotton material placed  
in between upholstery  
and burlap. 24in. wide.  
15.500-0.15  
..... **\$2.50 FT** ⚠

## Hog Rings



**HOGRING.....ALL**  
Upholstery hog rings,  
set of 100 pieces. -0.4  
..... **\$7.50 SET** ⚠



**HOGTOOL.....ALL**  
Hog ring upholstery  
pliers to install seat  
upholstery. 14.880-0.15  
..... **\$17.25 EA** ⚠

## Grommet



**3695783.....51-54**  
(anti-rattle) seat adjust  
rod. 16.682-0.15  
..... **\$5.00 EA** ⚠

## Seat Bumpers



**3681216.....36-46**  
These are the little  
rubber bumpers for  
between the top and  
bottom seat halves.  
16.772-0.15  
..... **\$3.75 PR** ⚠

## Seat Frame



**367314B.....47-54**  
Rear bumper &  
screw set (4 pieces).  
16.682-0.3  
..... **\$7.75 PR** ⚠

## Vintage Style Flashlight



**ACCFLASH.....ALL**  
Chrome flashlight has an all-metal casing,  
glass lens, hanging loop, adjustable beam,  
incandescent bulb, & Morse code button.,  
Uses 2 D cell batteries (not included) -0.15  
..... **\$9.00 EA** ⚠



**ACCFLASHBKT.....ALL**  
Mount for ACCFLASH w/ zinc plated  
finish -0.15  
..... **\$9.25 EA** ⚠



**ACCFLASHBKT2...ALL**  
Mount for ACCFLASH w/  
hammertone finish -0.15  
..... **\$14.00 EA** ⚠

**ACCFLASHLED.....ALL**  
Chrome flashlight has an all-metal casing,  
glass lens, hanging loop, adjustable beam,  
LED Bulb, & Morse code button., Uses 2 D  
cell batteries (not included) -0  
..... **\$12.50 EA** ⚠

## Dome Light Lens



**4073975.....37-46**  
With round stainless  
rim. Fits panel &  
Suburban. 16.494-0  
..... **\$35.00 EA** ⚠

## Dome Light Assembly



**5937080.....47-54**  
Original finish with lens,  
bulb & fasteners (6 or  
12 volt). 16.494-0  
..... **CALL** ⚠



**5937080C.....47-54**  
Chrome with lens, bulb  
& fasteners (6 or 12  
volt). 16.494-0  
..... **CALL** ⚠

## Dome Light Lens Gasket



**5937080A.....47-54**  
Gasket for dome light  
lens. 16.494-0.15  
..... **\$2.00 EA** ⚠

Returns require a return authorization number—call first. • Product pricing & availability subject to change.



**WARNING:** Cancer and  
Reproductive Harm —  
www.P65Warnings.ca.gov

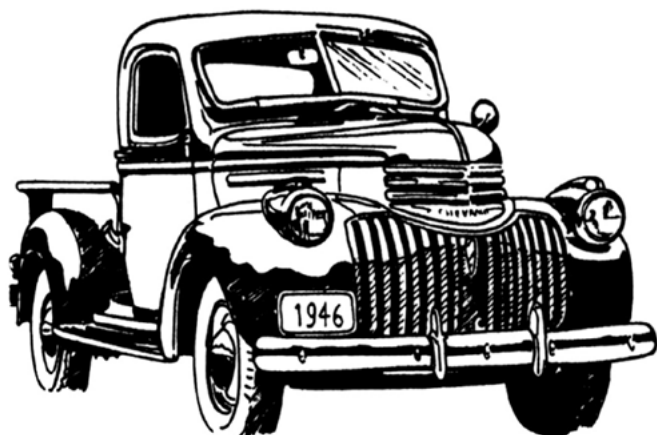

1936-9 Trk Choke, Throttle, Lights Black

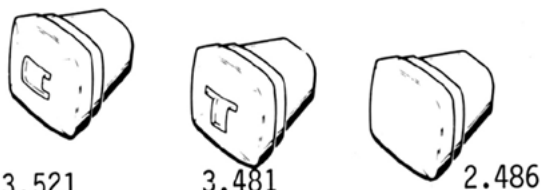

3.521 3.481 2.486  
1940-46 Trk Choke, Throttle, Lights Rose Tan

**WINDOW RISER KNOBS**

1939 Trk Window Knob Black

1940-46 Trk Window Rose Tan

1940-46 Trk Ash Tray Rose Tan



16.120

16.183

1947-53 Trk Vent Knob Maroon 1954 Trk Black



9.650

1954 Trk Windshield Wiper Black GMC Grey

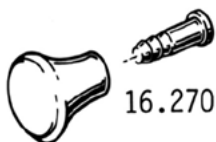

16.270

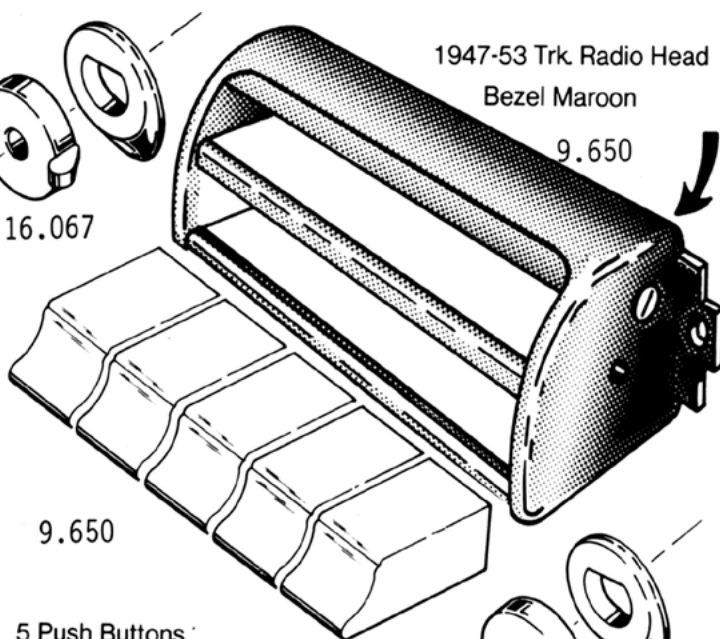

Radio Knobs—See Section 360T

1947-53 Trk Radio Head Bezel Maroon

9.650

16.067

9.650

5 Push Buttons  
1947-53 Trk 4 Piece Set

9.650

1947-53 Trk Radio Escutcheon Maroon

2.906

1954-9 P.U. Turnsignal Knob Black

9.650

1954 Trk Radio Black GMC Grey



**WARNING:** Cancer and Reproductive Harm — [www.P65Warnings.ca.gov](http://www.P65Warnings.ca.gov)

Chemicals shipped domestic ground only (Lower 48 states only). No international shipping.

Phone: (360) 816-0211 • (800) 999-CHEV (2438) • [www.chevsofthe40s.com](http://www.chevsofthe40s.com)

**SECTION 340T  
RESTORATION PARTS**

**Fan**



**40848.....ALL**  
12 volt 6" steel blade heavy duty fan. -0.15  
..... **\$38.00 EA** ⚠

**Traffic Light Viewer**



**986550.....50-56**  
Superb reproduction. 10.201 -0.15  
..... **\$46.00 EA** ⚠



**986550G.....50-56**  
"GUIDE". screw on mount. 10.201 -0.15  
..... **\$30.50 EA** ⚠



**986550MB.....ALL**  
"GUIDE" magnetic base mount. 10.201 -0.15  
..... **CALL** ⚠

**Steering Column Insulator**



**594670.....34-40**  
U-bolt with fasteners.  
6.765 -0.15  
..... **\$25.00 EA** ⚠



**3681057A.....34-46**  
Steering column to dash, brown exc COE.  
6.758 -0 ..... **\$13.50 EA** ⚠

**Steering Column Insulator, cont.**



**598145.....34-46**  
Steering column to dash, black exc COE.  
6.758 ..... **\$2.00 EA** ⚠



**3657031.....41-46**  
U-bolt with fasteners.  
6.765 -0.15  
..... **\$24.50 EA** ⚠



**3685524.....47-53**  
Steering column to dash, black exc COE.  
6.758 -0 ..... **\$3.00 EA** ⚠



**3700190.....54**  
Steering column to dash, black 6.758 -0.15  
..... **\$3.00 EA** ⚠

**Cowl Vent Knob**



**3656663A.....40-46**  
As original, brown.  
16.130 -0.15  
..... **\$8.75 EA** ⚠



**985603.....40-46**  
Ivory accessory 9.691 -0  
..... **\$15.00 EA** ⚠



**3682916A.....47-53**  
Side or top vent,  
maroon. 16.130 -0.15  
..... **\$7.00 EA** ⚠



**3131111.....54**  
Black. Original color  
and quality. 16.130 -0.4  
..... **\$14.00 EA** ⚠

**Wiper Knob**



**3685141.....47-49**  
Chrome Chevy & GMC 16.067 -0.4  
..... **\$6.00 EA** ⚠



**3699117.....50-53**  
Maroon Chevy & GMC, original color and  
quality. 16.067 -0.4 ..... **\$6.00 EA** ⚠



**3703853.....54**  
Black 16.067 -0.15  
..... **\$8.00 EA** ⚠

**Emergency Brake Release**



**3690404.....48-51**  
Handle (chrome).  
4.592 -0.15  
..... **\$10.00 EA** ⚠



**1990717.....52-53**  
Knob chrome w/  
maroon center. Original  
color and quality.  
4.600 -0  
..... **CALL** ⚠



**1990717A.....54**  
Knob (black). , original  
color and quality.  
4.600 -0.15  
..... **\$10.00 EA** ⚠

**Emergency Brake Release Grommet**



**3696521.....51-54**  
Emergency brake  
release 9.775 -0.15  
..... **\$5.50 EA** ⚠

**Windshield Crank Grommet**



**598986.....37-38**  
Grommet, windshield  
crank to dash.  
16.053 -0.15  
..... **\$1.75 EA** ⚠



**Window or Windshield Knob**



**598910A..... 39**  
Window or windshield crank. Black. 16.270 -0.15

..... **\$14.75 EA** ⚠️



**3654632B ..... 40-46**  
Window or windshield crank. Rose tan. 16.270 -0.15

..... **\$14.00 EA** ⚠️

**Windshield Crank**



**598909..... 39**  
W/ black knob 16.050 -0.15 **\$29.75 EA** ⚠️



**3654631A ..... 40-46**  
W/ brown knob 16.050 -0.15 **\$29.75 EA** ⚠️

**Turn Signal Knob**



**5939511A ..... 54-59**  
Black, original color and quality. 2.906 -0.4

..... **\$14.00 EA** ⚠️

**Headlight Knob**



**1861895..... 36-39**  
Black 2.486 -0.15

..... **\$14.00 EA** ⚠️



**599352..... 40-46**  
Rose tan 2.486 -0.15

..... **CALL** ⚠️



**1990661 ..... 47-53**  
Chrome with maroon center. With shaft 2.486 -0.15 **\$8.75 EA** ⚠️

**Headlight Knob, cont.**



**1990661A ..... 47-53**  
Chrome with maroon center. Original color and quality. 2.486 -0.15

..... **\$14.00 EA** ⚠️



**1990734..... 54**  
Exc forward control. Black. 2.486 -0.2

..... **\$9.00 EA** ⚠️



**3653818K ..... 54**  
With shaft. Black. 2.485 -0.15

..... **\$10.00 EA** ⚠️

**Choke Knob**



**476495A..... 36-39**  
Black, original color and quality. 3.521 -0

..... **CALL** ⚠️



**3657151A..... 40-46**  
Rose tan, original color and quality. 3.521 -0.15

..... **\$9.75 EA** ⚠️



**1992564A ..... 47-53**  
Chrome over maroon., original color and quality. 3.521 -0.2

..... **\$14.00 EA** ⚠️



**199637A..... 54**  
Exc Double Duty, COE, FFC. Black., original color and quality. 3.521 -0.4

..... **\$9.75 EA** ⚠️

**Choke Cable Assembly**



**476495..... 36-39**  
W/ knob 3.521 -0.4 **\$35.00 EA** ⚠️



**3657151..... 40-46**  
W/ knob, original color and quality. 3.521 -0.4 **\$30.00 EA** ⚠️

**Choke Cable Assembly, cont.**



**1992564 ..... 47-53**  
W/ knob 3.521 -0.15 **\$24.25 EA** ⚠️

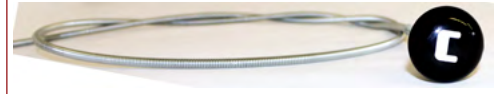

**199637..... 54**  
W/ knob-exc Double Duty, COE, FFC. 3.521 -0.15 **\$16.00 EA** ⚠️

**Throttle Knob**



**476751A..... 36-39**  
Black 3.481 -0.15 **\$14.00 EA** ⚠️



**3654274A..... 40-46**  
Rose tan, original color and quality. 3.481 -0.4

..... **\$14.00 EA** ⚠️



**1991581A ..... 47-53**  
Chrome over maroon, original color and quality. 3.481 -0.4

..... **\$14.00 EA** ⚠️



**1992599A ..... 54**  
Black exc Double Duty, COE, FFC., original color and quality. 3.481 -0.15

..... **\$14.00 EA** ⚠️

**Throttle Cable Assembly**



**476751..... 36-39**  
W/ knob 3.481 -0.4 **\$30.00 EA** ⚠️



**3654274..... 40-46**  
W/ knob, original color and quality. 3.481 -0.4 **\$30.00 EA** ⚠️

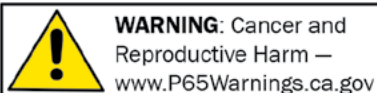

**WARNING: Cancer and Reproductive Harm —**  
www.P65Warnings.ca.gov

Chemicals shipped domestic ground only (Lower 48 states only). No international shipping.

**Phone: (360) 816-0211 • (800) 999-CHEV (2438) • www.chevsofthe40s.com**

**Throttle Cable Assembly, cont.**



**1991581** ..... **47-53**  
W/ knob 3.481 -0.15 ... **\$22.50 EA** ⚠



**1992599** ..... **54**  
W/ knob exc Double Duty, COE, FFC.  
3.481 -0.15 ..... **\$17.50 EA** ⚠

**Shift Knob**



**374993** ..... **29-47**  
3-speed floor shift push-on. Black. 4.009 -0.15  
..... **\$8.50 EA** ⚠



**374993B** ..... **29-54**  
4-speed screw-on. Black. Chevy & GMC  
4.009 -0.15 ..... **\$11.25 EA** ⚠

**Column Shift Knob**



**3686898** ..... **47-53**  
Maroon. Chevy & GMC  
4.009 -0.15 ..... **\$13.00 EA** ⚠



**3698233** ..... **54-59**  
Black Chevy & GMC  
4.009 -0.15 ..... **\$8.00 EA** ⚠

**Wire Stop**



**3655561** ..... **ALL**  
Adjustable end for hood, choke, throttle cables, etc. 8.077 -0.4  
..... **\$1.00 EA** ⚠

**Ash Tray Knob**



**3658055** ..... **40-46**  
Rose tan, original color and quality. 16.120 -0.4  
..... **\$14.00 EA** ⚠



**3685694** ..... **47-53**  
Chrome 16.122 -0.15  
..... **\$10.75 EA** ⚠

**Cigarette Lighter**



**986050K** ..... **47-53**  
12v w/ socket & knob maroon w/ chrome ring (original 51-53). 9.709 -0  
..... **\$23.50 EA** ⚠



**986050L** ..... **47-53**  
6v w/ socket & knob maroon w/ chrome ring (original 51-53). 9.709 -0.15  
..... **\$23.50 EA** ⚠



**3707720A** ..... **54**  
6v w/ socket & knob. 9.709 -0  
..... **\$21.75 EA** ⚠



**3707720B** ..... **54**  
12v w/ socket & knob. 9.709 -0  
..... **\$21.75 EA** ⚠



**986050J** ..... **ALL**  
6V w/ socket & element, no knob.  
9.709 -0.15 ..... **\$22.50 EA** ⚠

**Lighter Element**



**986050A** ..... **42-53**  
6v, fits original Casco (NOS). 9.709 -0.4  
..... **\$20.00 EA** ⚠

**Odds & Ends**

Please call for availability on all Odds & Ends parts. Once part is sold, it may no longer be in stock.

**3847003U** ..... **41-46**  
Firewall grommet bracket (Used) 3.000 -0.4  
..... **\$10.00 EA** ⚠





**SECTION 345T  
RESTORATION PARTS**

**Vanity Mirror**



**987919.....47-72**  
Vanity mirror with  
comb holder and clear  
comb. -0.15  
..... **\$125.25 EA** ⚠

**Tissue Dispenser**



**986672.....53-55**  
Superb repro, w/ bowtie. 8.891 -0.15  
**\$74.25 EA** ⚠



**TISSUE.....ALL**  
Box of tissue for tissue dispenser. 100  
sheets. -0.3 ..... **\$5.25 EA** ⚠

**Interior Mirror Bracket**



**986875A.....47-53**  
Stainless 16.069 -0.15  
..... **\$7.00 EA** ⚠



**986898.....54**  
This mirror bracket is  
for interior use on your  
'54. 16.069 -0.15  
..... **\$21.75 EA** ⚠



**986898A.....54**  
Chrome 16.069 -0.15  
..... **\$21.75 EA** ⚠

**Rear View Mirror**



**516506.....41-52**  
Chrome (exc. CBL,  
CVT, HTP & SDL).  
Dims: 6-3/4" x 2-1/2".  
10.185 -0.15  
..... **\$29.75 EA** ⚠

**Rear View Mirror, cont.**



**4584708.....53-59**  
Stainless 10.185 -0.15 ..... **\$25.50 EA** ⚠

**Rear View Mirror (Day/ Night)**



**985994.....41-50**  
Original 42-50 accessory. 10.185 -0  
..... **\$50.25 EA** ⚠



**986632.....51-52**  
Original accessory. 10.185 -0.15 .....  
**\$48.25 EA** ⚠



**986948.....53-59**  
Original accessory. 10.185 -0.15 .....  
**\$39.75 EA** ⚠

**Peep Mirror**



**985235A.....37-54**  
Original 40-50, less GM script, left.  
10.185 -0 ..... **\$19.50 EA** ⚠

**Peep Mirror, cont.**



**985231A.....ALL**  
Original era. 3in. round. Fits left or right.  
10.185 -0.15 ..... **\$15.50 EA** ⚠



**985231B.....ALL**  
Original era. 4in. round. Fits left or right.  
10.185 -0.15 ..... **\$15.50 EA** ⚠



**985231BL.....ALL**  
Original era. 4in. round. Now with built in  
LED arrow for signal. Fits left or right.  
10.185 -0.15 ..... **\$25.75 EA** ⚠



**985231E.....ALL**  
Extension for peep, moves mirror head out  
1-1/2" to increase visibility and safety  
10.185 -0.15 ..... **\$12.25 EA** ⚠



**985231SS.....ALL**  
Stainless visor for 4" Peep mirrors.  
10.185 -0.15 ..... **\$10.25 EA** ⚠



**WARNING:** Cancer and  
Reproductive Harm —  
www.P65Warnings.ca.gov

Chemicals shipped domestic ground only (Lower 48 states only). No international shipping.

**Phone: (360) 816-0211 • (800) 999-CHEV (2438) • www.chevsofthe40s.com**

# Section 345T: Tissue Dispenser, Mirrors & Mirror Arms

## Mirror Head



**3696632** .....31-54  
Exterior. 5" (as original). Fits left or right side. 16.068 -0.15 ..... **\$11.00 EA** ⚠



**3696632B** .....31-54  
Exterior. 5" (chrome). Fits Left or Right. 16.068 -0.15 ..... **\$14.25 EA** ⚠



**3696632R** .....47-72  
Exterior, rectangular (stainless). Fits left or right side. 16.068 -0.15 ..... **\$16.50 EA** ⚠



**3696632RB** .....47-72  
Exterior, rectangular (black). Fits Left or Right. 16.068 -0.15 ..... **\$14.00 EA** ⚠

## Exterior Mirror Arm



**592145** .....36-38  
Left 16.069 -0.15  
..... **\$31.75 EA** ⚠



**592146** .....36-38  
Right 16.069 -0.15  
..... **\$31.75 EA** ⚠



**599013L** .....39-46  
Left 16.069 -0.15  
..... **\$31.75 EA** ⚠



**599014R** .....39-46  
Right 16.069 -0.15  
..... **\$31.75 EA** ⚠

## Exterior Mirror Arm, cont.



**3684883** .....47-50  
Left, unfinished cast 16.068 -0.15 .....  
**\$18.00 EA** ⚠



**3695368** .....47-54  
Right 16.068 -0.15 ..... **\$20.50 EA** ⚠



**3695368C** .....47-54  
Right, chrome 16.068 -0.15 ... **\$25.75 EA**  
⚠



**3696059** .....47-54  
Left, original 51-54. Black 16.068 -0.15  
**\$20.50 EA** ⚠



**3696059C** .....47-54  
Left, chrome, original 51-54. 16.068 -0.15  
..... **\$25.75 EA** ⚠

## Mirror Arm Screws



**604714A** .....47-54  
Mirror arm, outside,  
stainless steel (2 pcs).  
16.069 -0.15  
..... **\$2.25 SET** ⚠

## Mirror Arm Gasket



**597606** .....47-54  
Mirror arm to cowl,  
outside. 16.069 -0.15  
..... **\$3.25 EA** ⚠

## Mirror Arm Pad



**597606A** .....47-54  
Mirror arm (rubber  
w/ beaded edge).  
16.069 -0.3

..... **\$2.75 EA** ⚠

## Odds & Ends

Please call for availability on all Odds & Ends parts. Once part is sold, it may no longer be in stock.

**3696059U** .....47-54  
Exterior mirror arm. Left, original for 51-54. Need screw & gasket (Used). 16.068 -0.4  
..... **\$15.00 EA** ⚠

**516505U** .....ALL  
Rear view mirror. Painted back (Used). 10.185 -0.4  
..... **\$40.00 EA** ⚠



# Section 350T: Gauges, Dash Panels, Instrument Glass, Dash Parts, Glove Boxes & Voltage Reducers

## SECTION 350T STREET ROD PARTS

### Dash Panel-LED Lights



**WASL18GRA1-4 . . . . .ALL**  
Choose Green, Red or Amber. 1/4" dia. Use for turn, high beam or power indicators. 12

vdc. -0.15  
..... **\$6.00 EA** ⚠



**WASL18GRA5-32 . . . . .ALL**  
Choose Green, Red or Amber. 5/32" dia. Use for turn, high beam or power indicators. 12

V. -0.15  
..... **\$6.00 EA** ⚠

## SECTION 350T RESTORATION PARTS

Dash Paint see Section 15T.

### Shift Indicator Dial



**3705999R . . . . .54-57**  
Shifter Indicator Dial fits 54-57 Hydramatic 4.038-0  
..... **\$54.00 EA** ⚠

### Dash Panel

**ALUMDASH . . . . . 37**  
Billet aluminum polished for five gauges. Fits most gauges. Specify when ordering.. Gauges not included. 10.230 -0.15  
..... **\$134.99 EA** ⚠



**ALUMDASH . . . . . 40-46**  
Billet aluminum polished for five gauges. Fits most gauges. Specify when ordering.. Gauges not included. 10.230 -0.15  
..... **\$137.50 EA** ⚠

### Dash Panel, cont.



**ALUMDASHQ . . . . . 40-46**  
Billet aluminum polished for two 3-3/8in gauges. Fits most gauges. Specify when ordering.. Gauges not included. 10.230 -0.15  
..... **\$137.50 EA** ⚠



**ALUMDASHT . . . . . 40-46**  
Billet aluminum polished for 3 gauges. Fits most 3-3/8" gauges. Specify when ordering. Gauges not included. 10.230 -0.15  
..... **\$137.50 EA** ⚠



**3847353A . . . . . 47-53**  
Complete metal replacement. Superior!. 16.550 -0.15  
..... **\$349.00 EA** ⚠



**ALUMDASH5 . . . . . 47-53**  
Billet aluminum polished for two 5in gauges. Fits most gauges. Specify when ordering.. Gauges not included. 10.230 -0.15  
..... **\$102.00 EA** ⚠

**ALUMDASH5 . . . . . 54**  
Billet aluminum polished for two 5in gauges. Fits most gauges. Specify when ordering.. Gauges not included. 10.230 -0.15  
..... **\$118.00 EA** ⚠

### Voltage Reducer



**1119004 . . . . . ALL**  
Reducer 12v to 6v. Best for fuel gauge. Hi-Tech w/ constant volts.  
2.500 -0.15  
..... **\$20.25 EA** ⚠

### Voltage Reducer, cont.



**1119004A . . . . . ALL**  
12v conversion. 1 per gauge Hi-Tech w/ voltage not constant. 2.500 -0.15  
..... **\$4.50 EA** ⚠

**1119004B . . . . . ALL**  
Single 12v input, dual 6v outputs. 2.500 -0.15  
..... **\$38.50 EA** ⚠



**1119005 . . . . . ALL**  
12v to 6v voltage reducer to operate heater, radio & gauges. Hi-tech, delivers constant volts. Superior quality. 2.500 -0.15  
..... **\$93.25 EA** ⚠



**1119005C . . . . . ALL**  
12v to 6v voltage reducer to operate heater. 2.500 -0.15  
..... **\$19.75 EA** ⚠



**1506373A . . . . . ALL**  
12v to 6v. Up to 4 amp draw affects voltage. 2.500 -0.4  
..... **\$8.50 EA** ⚠

### Voltage Booster



**1119007 . . . . . ALL**  
6v to 12v high current booster (3.7-5.0 amps) great for: radar detectors, CB radios, mobile phones, modern stereo radios w/ CD & tape and alarm systems (control only). 2.500 -0.15  
..... **\$97.00 EA** ⚠

### Gauge Repair

\$10 shipping & handling fee for electrical gauge repair. Parts needed for repair will be in addition to servicing.

**1565912R . . . . . ALL**  
Speedometer gauge repair service. Parts extra 9.743 -0.15  
..... **\$190.00 EA** ⚠

### Gauge Cluster

**858983R6 . . . . . 36-39**  
Rebuilt fits 6 cylinder (\$150 core). 9.748 -0.15  
..... **\$643.50 EA** ⚠



**WARNING:** Cancer and Reproductive Harm — [www.P65Warnings.ca.gov](http://www.P65Warnings.ca.gov)

Chemicals shipped domestic ground only (Lower 48 states only). No international shipping.

Phone: (360) 816-0211 • (800) 999-CHEV (2438) • [www.chevsofthe40s.com](http://www.chevsofthe40s.com)

# Section 350T: Gauges, Dash Panels, Instrument Glass, Dash Parts, Glove Boxes & Voltage Reducers

## Gauge Cluster, cont.



**1564308R6** ..... **40-46**  
Rebuilt fits 6 cylinder. 0-30psi oil pressure (\$150 core). 9.748 -0.15 .....  
**\$572.00 EA** ⚠



**1564309R6** ..... **40-46**  
Rebuilt fits 6 cylinder. 0-60psi oil pressure (\$150 core). 9.748 -0.15 .....  
**\$598.50 EA** ⚠

**1500924R6** ..... **47-54**  
Rebuilt fits 6 cylinder (\$150 core). 9.748 -0.15 .....  
**\$425.00 EA** ⚠

## Gauge Cluster (V8)

**858983R8** ..... **36-39**  
Rebuilt fits V8 (\$150 core). 9.748 -0.15 .....  
**\$700.75 EA** ⚠

**1564308R8** ..... **40-46**  
Rebuilt fits V8 (\$150 core). 9.748 -0.15 .....  
**\$572.00 EA** ⚠

**1500924R8** ..... **47-54**  
Rebuilt fits V8 (\$150 core). 9.748 -0.15 .....  
**\$507.00 EA** ⚠

## DirectFit RestoMod Gauges

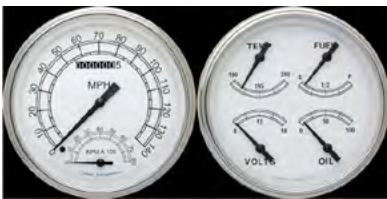

**CT47CW62** ..... **47-53**  
1947-53 GM Pick-Up Package Classic White Series 4 5/8" Speedtachular (Speedometer/ Tachometer Combination) & Quad (Fuel 240-33 OHM) with Stainless Low Step Bezel Flat Glass Lens. The package includes model specific rings, mounting hardware, and all sending units. -0.15 .....  
**\$875.25 EA** ⚠

## DirectFit RestoMod Gauges, cont.



**CT47VT52** ..... **47-53**  
1947-53 GM Pick-Up Package Vintage Series 4 5/8" Speedometer & Quad (Fuel 240-33 OHM) with Stainless Low Step Bezel Flat Glass Lens. The package includes model specific rings, mounting hardware, and all sending units. -0.15 .....  
**\$659.00 EA** ⚠

## Speedometer Hand



**1567794** ..... **47-50**  
Super quality (also 52-53 GMC). 9.748 -0.15 .....  
**\$7.75 EA** ⚠



**1567795** ..... **51-53**  
Super! 9.748 -0.15 .....  
**\$7.75 EA** ⚠



**1567795A** ..... **51-53**  
Needle only 9.748 -0 .....  
**\$7.50 EA** ⚠

## Speedometer Cable



**1567793** ..... **37-57**  
W/ original housing assembly exc 1939-54. 4.342 -0 .....  
**\$56.00 EA** ⚠

**1588291A** ..... **37-57**  
Cable without housing. 85" length (0.130 dia.). 4.342 -0.15 .....  
**\$5.75 EA** ⚠

**158829** ..... **39-54**  
W/ original metal housing assembly. 70" length. 4.342 -0 .....  
**\$18.00 EA** ⚠

## Bushing In Cylinder Head



**3837160** ..... **38-62**  
For temp gauge. 3/8" I.D. 1/2" NPT O.D. 1.150 -0.15 .....  
**\$9.75 EA** ⚠

## Oil Pressure Line



**1399637B** ..... **37-54**  
Engine to oil gauge. 1.519 -0.3 .....  
**\$26.00 EA** ⚠

## Instrument Glass



**1564308G** ..... **40-46**  
With original markings (GMC). 9.748 -0.15 .....  
**\$17.00 EA** ⚠



**1565308** ..... **40-46**  
With original markings (Fits 1940 Car, and 1940-46 Truck) 9.748 -0.15 .....  
**\$19.75 EA** ⚠



**1565308A** ..... **40-46**  
V8 markings w/ temp to 220 degrees & oil pressure at 60 psi (Fits 1940 Car, and 1940-46 Truck). 9.748 -0.15 .....  
**\$20.50 EA** ⚠

## Decal Instrument Set



**858983** ..... **36-39**  
Instrument set w/ speedo & odometer (black center). 9.748 -0.15 .....  
**\$15.00 EA** ⚠

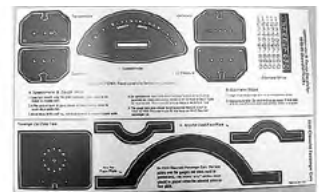

**1564308B** ..... **40-46**  
Instrument cluster w/ speedo & odometer. 9.748 -0 .....  
**\$13.00 EA** ⚠

Returns require a return authorization number—call first. • Product pricing & availability subject to change.



**WARNING:** Cancer and Reproductive Harm — www.P65Warnings.ca.gov

**Decal Instrument Set, cont.**

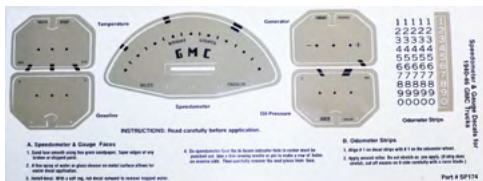

**1564308H** ..... **40-46**  
Instrument cluster w/ speedo & odometer (GMC). 9.748 -0.15 ..... **\$12.75 EA** ⚠️



**1500924B** ..... **47-50**  
Instrument set w/ speedo & odometer. 9.748 -0.15 ..... **\$17.00 SET** ⚠️



**1500924G** ..... **47-53**  
Instrument set w/ speedo & odometer (GMC). 9.746 -0.15 ..... **\$12.25 SET** ⚠️



**1500924C** ..... **51-53**  
Instrument set w/ speedo & odometer. 9.748 -0.15 ..... **\$17.00 SET** ⚠️



**1582460C** ..... **54**  
Instrument set w/ speedo & odometer. 9.748 -0.15 ..... **\$12.25 EA** ⚠️

**Decal Instrument Set, cont.**



**1582460G** ..... **54-59**  
Instrument set w/ speedo & odometer (GMC). 9.748 -0.15 ..... **\$25.00 EA** ⚠️

**Gauge Cluster Bezel**



**1565472** ..... **40-46**  
Chrome (Chev & GMC). 9.746 -0.15 ..... **\$46.00 EA** ⚠️



**1581526** ..... **47-53**  
W/ speedo (Chev & GMC), chrome. 9.746 -0.15 ..... **\$14.50 EA** ⚠️



**1582659** ..... **54-55**  
Chrome. 9.746 -0.15 ..... **\$22.00 EA** ⚠️



**1582659S** ..... **54-55**  
Stainless. 9.746 -0.15 ..... **\$24.00 EA** ⚠️

**Instrument Gasket**



**1565309** ..... **40-46**  
Instrument glass to housing (Chev & GMC). 9.749 -0.15 ..... **\$5.75 EA** ⚠️



**1500925** ..... **47-53**  
Speedometer Chev gauge glass to bezel (Chev & GMC). 9.749 -0.3 ..... **\$4.00 PR** ⚠️

**Billet Glove Box Door & Speaker Grille**



**4753BD** ..... **47-53**  
Billet aluminum speaker grille and glove box door. Pieces are CNC milled from 6061 aluminum and come with a machined finish. Speaker Grille Cover has the ash tray deleted. All required mounting hardware included. Custom Engraving Available! -0 ..... **\$600.00 SET** ⚠️



**4753PBD** ..... **47-53**  
Billet Dash With Glove Box Door -0 ..... **\$830.00 EA** ⚠️

**Dash Moulding Speaker Grille**



**3654082B** ..... **40-46**  
Mouldings - On dash below instruments & glove box - with attaching clips 16.081 -0.15 ..... **\$70.00 SET** ⚠️



**3654550** ..... **40-46**  
For moulding across dash (10 pcs). 12.118 -0.3 ..... **\$6.25 SET** ⚠️



**3684033** ..... **47-53**  
Dash moulding assembly speaker grille w/ script & ashtray assembly (painted). Upper and lower mouldings are stainless and ashtray knob is chrome. 16.083 -0.15 ..... **\$111.75 EA** ⚠️

# Section 350T: Gauges, Dash Panels, Instrument Glass, Dash Parts, Glove Boxes & Voltage Reducers

## Dash Moulding Speaker Grille, cont.



**3684033G** .....47-53  
Dash moulding assembly speaker grille w/ script & ashtray assembly, GMC (painted). Upper and lower mouldings are stainless and ashtray knob is chrome. 16.083 -0.15  
..... **\$111.75 EA** ⚠

## Glove Box Door



**598857** ..... **39**  
Hinge assembly  
10.262 -0.15

..... **\$44.50 EA** ⚠



**3693927B** .....47-53  
Hinges 16.115 -0.15

..... **\$38.00 L&R** ⚠



**3698751** .....47-53  
Stainless with painted details. (Driver quality) 16.110 -0.15  
..... **\$99.50 EA** ⚠

## Glove Box Door



**3698751S** .....47-53  
Stainless unpainted. (Driver quality)  
16.110 -0.15  
..... **\$89.50 EA** ⚠

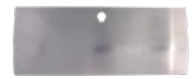

**3701367B** .....54-55  
54-55 1st series  
Billet Glove Box Door

Machine Finish 16.110 -0  
..... **\$350.00 EA** ⚠

**3701367BP** .....54-55  
54-55 1st Series Billet Glove Box Door  
Polished Finish 16.110 -0

..... **\$399.00 EA** ⚠

## Decal Radio Grille



**306543** .....47-53  
Chevrolet radio grille. Black lettering.  
18.550 -0.15  
..... **\$3.50 EA** ⚠

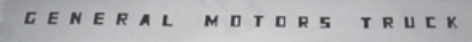

**306543G** .....47-53  
GMC radio grille. 18.550 -0  
..... **\$6.00 EA** ⚠

## Glove Box



**473524** .....36-38  
W/ clips 16.100 -0.15  
..... **\$14.50 EA** ⚠



**473524C** .....36-38  
Cloth lined W/ clips 16.100 -0.15  
..... **\$27.00 EA** ⚠

**598886** ..... **39**  
W/ clips 16.100 -0.15  
..... **\$13.00 EA** ⚠

**598886C** ..... **39**  
Cloth lined W/ clips 16.100 -0.15  
..... **\$27.00 EA** ⚠

**3654001** ..... **40-46**  
W/ clips 16.100 -0.15  
..... **\$13.00 EA** ⚠

**3654001C** ..... **40-46**  
Cloth lined W/ clips 16.100 -0.15  
..... **\$27.00 EA** ⚠

**3676451** .....47-49  
Without clips. 16.100 -0.15  
..... **\$12.50 EA** ⚠

**367645AIR** .....47-49  
Trucks with A/C, moulded from ABS  
16.100 -0  
..... **\$116.00 EA** ⚠

**3704220** ..... **50-53**  
W/ clips 16.100 -0.15  
..... **\$13.00 EA** ⚠

**3701366** ..... **54**  
W/ clips 16.100 -0.15  
..... **\$12.50 EA** ⚠

## Glove Box, cont.

**3701366G** ..... **54**  
W/ clips (GMC). 16.100 -0.15  
..... **\$12.50 EA** ⚠

## Screw Set



**431616** .....**ALL**  
To install glove box  
10.261 -0.4  
..... **\$1.75 SET** ⚠

## Rubber Bumpers



**4072911B** .....**37-39**  
Glove box door  
(rectangle). 11.139 -0.4  
..... **\$0.75 SET** ⚠



**3765243** .....**40-54**  
Glove box door (round).  
10.263 -0.4  
..... **\$1.75 PR** ⚠

## Glove Box Light



**985772** .....**37-54**  
w/ bulb. 12V. 10.275 -0.2  
..... **\$25.00 EA** ⚠

## Striker



**3701376** .....**54-59**  
Glove box latch.  
16.110 -0.2  
..... **\$8.75 EA** ⚠

## Gasket



**4099314C** .....**40-53**  
Glove box lock to door.  
16.110 -0.2  
..... **\$0.75 EA** ⚠



**4566764A** ..... **54**  
Glove box lock to door.  
16.110 -0.2  
..... **\$2.25 EA** ⚠

## Glove Box Lock



**4099314** .....**40-53**  
Assembly with  
key. Chevy & GMC  
16.110 -0.15  
..... **\$31.00 EA** ⚠



**4099314B** .....**40-53**  
Retainer for glove  
box lock assembly.  
16.110 -0.2  
..... **\$8.25 EA** ⚠



**4566764B** ..... **54**  
Assembly with case  
& key. Chevy & GMC  
10.266 -0.2  
..... **\$30.75 EA** ⚠

Returns require a return authorization number—call first. • Product pricing & availability subject to change.



**WARNING:** Cancer and Reproductive Harm — www.P65Warnings.ca.gov

# Section 350T: Gauges, Dash Panels, Instrument Glass, Dash Parts, Glove Boxes & Voltage Reducers

## Glove Box Lock Retainer



**4099314A** .....40-54  
Repair Kit (hook & pin).  
16.110 -0.15

..... **\$4.00 KIT** ⚠



**4599106**.....54-59  
Retainer for glove box  
lock assembly. Chevy &  
GMC 10.267 -0

..... **\$3.75 EA** ⚠

## Key Blank



**601272**.....35-54  
Original GM round  
head. Fits trunk, glove  
box & locking gas cap

2.187 -0.2

..... **\$4.00 EA** ⚠



**3694624**.....35-57  
Original GM octagon  
head. Fits ignition,  
door & spare tire locks.

2.187 -0.15

..... **\$2.50 EA** ⚠

## Odds & Ends

Please call for availability on all Odds & Ends parts. Once part is sold, it may no longer be in stock.

**1506092** .....40-42  
Shelf worn 1.803 -0.4

..... **\$45.00 EA** ⚠

**1500558** .....40-46  
Ammeter. Fits 40 Pass & 41-46 Truck  
(NOS). 2.055 -0.15

..... **\$60.00 EA** ⚠

**1506373** .....40-46  
Oil Gauge- 40 Pass, 41-46 Truck (NOS)  
28.000 -0

..... **\$50.00 EA** ⚠

**1565473** .....40-46  
Retainer - instrument face 9.747 -0.4

..... **\$15.00 EA** ⚠

**1506379** .....41-46  
Oil Pressure Gauge GMC 0-80 PSI NOS  
28000.000 -0.4

..... **\$65.00 EA** ⚠

**1507088N** .....47-48  
Oil Pressure Gauge Red Needle (NOS)  
28000.000 -0.4

..... **\$50.00 EA** ⚠

**1500924** .....47-53  
Instrument glass, used 9.748 -0.4

..... **\$15.00 EA** ⚠

**1511960** .....47-53  
Temp gauge GMC GMC -0.4

..... **\$100.00 EA** ⚠

**1511960U** .....47-53  
Temp gauge GMC. Needs new needle  
(Used) GMC -0.4

..... **\$60.00 EA** ⚠

**1516973G** .....47-53  
Cluster gear bezel fits GMC has yellow  
face 9.748 -0

..... **\$15.00 EA** ⚠

**1501198N** .....49-53  
Ammeter. Fits comm & utility 54-55 FFC  
(NOS) 28000.000 -0

..... **\$50.00 EA** ⚠

**1507401**.....49-53  
Oil gauge white needle (COMM, Utility)  
28000.000 -0.4

..... **\$50.00 EA** ⚠

**1501471**..... 54  
Ammeter NOS 28000.000 -0.4

..... **\$37.50 EA** ⚠

**1508246** .....55-57  
Oil Pressure Gauge 1.803 -0.4

..... **\$50.00 EA** ⚠

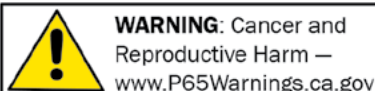

Chemicals shipped domestic ground only (Lower 48 states only). No international shipping.

Phone: (360) 816-0211 • (800) 999-CHEV (2438) • www.chevsofthe40s.com

**SECTION 360T  
STREET ROD PARTS**

**Power Antenna**



**984995P .....ALL**  
Fully automatic. Fits on top of cowl or fender. 9.645 -0.15 ..... **\$77.75 EA** ⚠️

**1947-53 New Radio**

Small size, big features! Original looking unit with current day audio technology. Fits stock dash radio opening without modifications. Shallow 3-1/4 inch case depth allows room for dash components such as electric wipers, air conditioning, etc. 4 x 45 watts RMS output, allows up to 180 watts of audio power. Original style AM dial scale in foreground with FM dial scale in background. Analog controls look and feel like the original radio. All audio controls are easily accessible: Volume, bass, treble, balance, fader and tuner from original looking controls. CD or XM (satellite) inputs included. LED dial lights which never need replacing. Digitally tuned AM/FM/Stereo front end provides stable, high quality reception with 10 station presets (5 AM, 5 FM). 40 year memory retention (presets, etc) with power disconnected. Inputs for CD. Maximum power = 180 watts RMS (45 watts x 4 speakers). Dimensions: 9in. W x 3.25in. H x 4.6in. D. 1/2" dia. shafts on controls for mounting (same size and thread as original shafts). Made in the USA. 1 year guarantee.



**986444R .....47-53**  
Radio without speaker 9.650 -0.15 .....  
**\$631.00 EA** ⚠️

**1947-53 New Radio, cont.**



**986444RG .....47-53**  
GMC without speakers 9.650 -0.15 .....  
**\$632.50 EA** ⚠️



**986444S .....47-53**  
Radio with speakers. Pair of 4in x 6in mounted to new radio. 9.650 -0.15 .....  
**\$746.25 SET** ⚠️

**1954-55 (1st Series) New Radio**

First time a NEW radio has been available for this truck in 50 years! Offers the same features as the 47-53 unit plus: Chrome plated die cast nose piece looks original.

Includes primed dash bezel exactly like the original (must be painted to match) and correct knobs.

Optional Dash Speaker (shown) provides two 4"x6" 3-way speakers that fit in original 6"x 9" opening.



**986771CG ..... 54**  
GMC without speakers 9.650 -0.15 .....  
**\$577.50 EA** ⚠️



**986771R .....54-55**  
Radio with out speakers 9.650 -0.15 .....  
**\$577.50 EA** ⚠️

**1954-55 (1st Series) New Radio, cont.**



**986771S .....54-55**  
Radio with speakers. Pair of 4in x 6in mounted to new radio (not sold separately). 9.650 -0.15 .....  
**\$693.00 SET** ⚠️

**SECTION 360T  
RESTORATION PARTS**

Note: Radio & Heater Paint see Section 15T.

**Voltage Booster -Radio**



**1119007 .....ALL**  
6v to 12v high current booster (3.7-5.0 amps) great for: radar detectors, CB radios, mobile phones, modern stereo radios w/ CD & tape and alarm systems (control only). 2.500 -0.15

..... **\$97.00 EA** ⚠️

**Antenna**

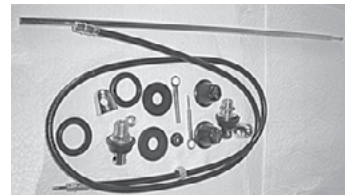

**985531 .....39-46**  
W/ original side mount posts. Superior!  
9.645 -0 ..... **CALL** ⚠️



**986069 .....47-54**  
W/ template. Superb Reproduction.  
9.645 -0.15 ..... **\$120.00 EA** ⚠️



**984995R .....ALL**  
Cowl Top or fender top replacement. Adjustable base (swivels). 9.645 -0.2 ...  
**\$22.25 EA** ⚠️



**Antenna, cont.**

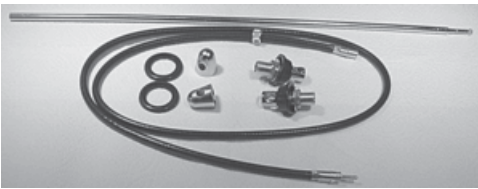

**985996R** ..... **ALL**  
2 post side cowl mount. 9.645 -0.15 .....  
**\$33.00 EA** ⚠

**Antenna Eye Bolt**



**603797** ..... **39-46**  
Antenna upper eye bolt for base takes 2 (1941 uses 1). 9.644 -0.2 .....  
**\$21.25 EA** ⚠

**Antenna Base**



**603795** ..... **39-46**  
Bakelite post base. 39-40 takes 2, 41 takes 1. 9.644 -0.3 .....  
**\$24.25 EA** ⚠

**Antenna Base & Nut**



**986069A** ..... **47-54**  
Base & nut. Fits Bakelite. 9.645 -0.15 .....  
**\$19.75 SET** ⚠

**Antenna Pad**



**605184** ..... **39-46**  
Rubber pad for bakelite post (original antenna). 9.645 -0 .....  
**\$9.25 PR** ⚠



**986069C** ..... **47-54**  
Rubber pad for antenna base. 9.645 -0.15 .....  
**\$4.50 EA** ⚠

**1937 Radio**

**985252A** ..... **37**  
Tube set, 6-tube single unit radio #985252. 9.650 -0 .....  
**\$89.00 SET** ⚠

**1938 Radio**



**7232768** ..... **38**  
Radio knob, ivory. Original color and quality. 9.650 -0.4 .....  
**\$14.00 EA** ⚠

**1939 Radio**



**7232626** ..... **37-39**  
Radio dial lens, 2in. diameter. 9.650 -0.2 .....  
**\$35.50 EA** ⚠

**985286A** ..... **38-39**  
Tube set, 6-tube single unit radio #985286. 9.650 -0 .....  
**\$108.00 SET** ⚠



**7236509** ..... **39**  
Radio knob, rose tan. Original color and quality. 9.650 -0 .....  
**CALL** ⚠

**1940 Radio**



**7239043** ..... **40**  
Radio knob, ivory. Original color and quality. 9.650 -0 .....  
**CALL** ⚠

**985538A** ..... **40**  
Tube set, 5-tube single unit radio #985538. 9.650 -0 .....  
**\$102.00 SET** ⚠

**1941 Radio**



**1213876** ..... **40-41**  
Radio dial lens, 3-5/8in. x 7/8in., glass. 9.650 -0.15 .....  
**\$23.50 EA** ⚠



**7238833** ..... **40-41**  
Radio dial lens, 3-1/2in. x 1-1/4in., plastic. 9.650 -0 .....  
**CALL** ⚠

**985651A** ..... **40-41**  
Tube set, 5-tube plug in portable radio #985651. 9.650 -0 .....  
**\$45.00 SET** ⚠



**604369** ..... **41**  
Radio knob, chrome with swirl center. 9.650 -0.4 .....  
**\$14.00 EA** ⚠

**985696A** ..... **41**  
Tube set, 5-tube single unit radio #985696. 9.650 -0.15 .....  
**\$134.00 SET** ⚠

**1942-1946 Radio**



**7242249** ..... **42-46**  
Radio knob, ivory w/ copper swirl center. 9.650 -0 .....  
**CALL** ⚠

**985792A** ..... **42-46**  
Tube set, 5-tube single unit radio #985792. 9.650 -0 .....  
**\$111.00 SET** ⚠

**1947-1953 Radio**



**7256902** ..... **47-50**  
Radio dial lens, molded plastic. 9.650 -0 .....  
**CALL** ⚠

**986067A** ..... **47-50**  
Tube set, 6-tube single unit radio #986067. 9.650 -0.15 .....  
**\$146.00 SET** ⚠



**3684033** ..... **47-53**  
Dash moulding assembly speaker grille w/ script & ashtray assembly (painted). Upper and lower mouldings are stainless and ashtray knob is chrome. 16.083 -0.15 .....  
**\$111.75 EA** ⚠



**3684033G** ..... **47-53**  
Dash moulding assembly speaker grille w/ script & ashtray assembly, GMC (painted). Upper and lower mouldings are stainless and ashtray knob is chrome. 16.083 -0.15 .....  
**\$111.75 EA** ⚠

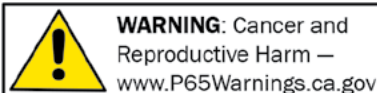

Chemicals shipped domestic ground only (Lower 48 states only). No international shipping.

**Phone: (360) 816-0211 • (800) 999-CHEV (2438) • www.chevsofthe40s.com**

**1947-1953 Radio, cont.**



**4753BD** .....47-53  
Billet aluminum speaker grille and glove box door. Pieces are CNC milled from 6061 aluminum and come with a machined finish. Speaker Grille Cover has the ash tray deleted. All required mounting hardware included. Custom Engraving Available! -0 ..... **\$600.00 SET** ⚠



**4753PBD** .....47-53  
Billet Dash With Glove Box Door  
-0 ..... **\$830.00 EA** ⚠



**986264** .....47-53  
Radio knob, tan. 9.650 -0  
..... **\$14.00 EA** ⚠



**986264A** .....47-53  
Disk dummy (knob) behind front radio knob. 9.650 -0  
..... **\$14.00 EA** ⚠



**986264B** .....47-53  
Disk w/ lever (knob) behind front radio knob. 9.650 -0  
..... **\$14.00 EA** ⚠



**9864445** .....47-53  
Rubber seal, radio speaker to dash. 9.650 -0.15 ..... **\$14.50 EA** ⚠



**9864445S** .....47-53  
Sponge seal, radio speaker to dash. 9.650 -0.15 ..... **\$12.00 EA** ⚠

**986444A** .....47-53  
Radio bezel gasket (2 pcs). 9.650 -0.15  
..... **\$3.50 PR** ⚠

**1947-1953 Radio, cont.**



**986444C** .....47-53  
Radio bezel, teardrop behind knobs Original color and quality. 9.650 -0.15  
..... **\$14.00 EA** ⚠



**986444D** .....47-53  
Pushbuttons (5 pcs). 9.650 -0.15 ..... **\$15.50 SET** ⚠



**986444EF** .....47-53  
Spacers, front of radio to dash. Upper and Lower (4pcs). 9.650 -0  
..... **\$15.50 SET** ⚠



**986694D** .....47-53  
Radio face housing, maroon. 9.650 -0.4  
..... **\$20.00 EA** ⚠



**4754RD** .....47-54  
Radio Delete is laser cut from 18 gauge steel and gives the option to be bolted in or welded in. -0 ..... **\$50.00 EA** ⚠

**986443A** .....51-53  
Tube set, 6-tube single unit radio #986443. 9.650 -0.15  
..... **\$146.00 SET** ⚠

**1954 Radio**



**986668B** .....54  
Radio dial lens, GMC. 9.650 -0.15 ..... **\$18.50 EA** ⚠



**986669B** .....54  
Radio dial lens. 9.650 -0.15 ..... **\$25.00 EA** ⚠

**1954 Radio, cont.**



**986694** .....54  
Disk w/ lever (knob), black, behind radio knob. Original color and quality. 9.650 -0.15  
..... **\$14.00 EA** ⚠



**986694C** .....54  
Radio face housing (rough casting) 9.650 -0.15 ..... **\$29.00 EA** ⚠



**986694E** .....54  
Radio knob, black (outer). Original color and quality. 9.650 -0.15  
..... **\$14.00 EA** ⚠



**986694H** .....54  
Disk dummy (knob) black behind radio knob. Original color and quality. 9.650 -0.15  
..... **\$14.00 EA** ⚠



**986694J** .....54  
Radio knob, GMC. Grey (outer). Original color and quality. 9.650 -0.15  
..... **\$14.00 EA** ⚠



**986694K** .....54  
Disk dummy (knob), grey, GMC, behind radio knob. Original color and quality. 9.650 -0.15  
..... **\$14.00 EA** ⚠



**986694L** .....54  
Disk w/ lever (knob) grey, GMC, behind radio knob. Original color and quality. 9.650 -0.15  
..... **\$14.00 EA** ⚠

**986770A** .....54  
Tube set, 6-tube single unit radio #986770. 9.650 -0  
..... **\$126.00 SET** ⚠



**986770C** .....54  
Radio speaker cover, cardboard. 9.650 -0.15  
..... **\$10.00 EA** ⚠



**1954 Radio, cont.**



**986771BKT** .....**54-55**  
 1st Series radio mounting bracket  
 9.650 -0.15 ..... **\$50.00 EA** ⚠

**Bluetooth Adapter**



**BT01** .....**ALL**  
 Bluetooth adapter for  
 radios with an auxiliary  
 input. -0.15  
 ..... **\$40.00 EA** ⚠

**Radio Tubes**



**1211924** .....**37-54**  
 OZ-4. Solid state (\$15 core-exchange).  
 9.650 -0.4 ..... **\$50.00 EA** ⚠

**Vibrator**



**7239124E** .....**37-38**  
 6v w/ negative grounds. Solid state, no  
 more radio hum (if original vibrator doesn't  
 hum, it's time to replace it). 9.650 -0  
 ..... **CALL** ⚠



**7239124** .....**39-54**  
 6v w/ negative grounds. Solid state, no  
 more radio hum (if original vibrator doesn't  
 hum, it's time to replace it). 9.650 -0.15  
 ..... **\$56.50 EA** ⚠

**Vibrator, cont.**



**7239124R** .....**ALL**  
 12v w/ negative grounds. Solid state, no  
 more radio hum (if original vibrator doesn't  
 hum, it's time to replace it). 9.650 -0.15  
 ..... **\$56.50 EA** ⚠

**Thin Hex Nut**



**120369** .....**ALL**  
 For 3/8in. Shaft-radio  
 (2 Pc Set) 9.650 -0.4  
 ..... **\$3.00 SET** ⚠



**604275** .....**ALL**  
 For 1/2in. Shaft-radio  
 (2 Pc Set) 9.650 -0.4  
 ..... **\$6.25 SET** ⚠

**Odds & Ends**

Please call for availability on all Odds & Ends  
 parts; once part is sold, it may no longer be in  
 stock.

**7239124U** .....**39-54**  
 Vibrator - 6 volt used. 1.664 -0.4  
 ..... **\$20.00 EA** ⚠

**605300N** .....**42-48**  
 Knob. Radio (small ivory w/ swirl)  
 9.650 -0.4  
 ..... **\$15.00 EA** ⚠



**1948 Fire Truck — Nicholas & Audrey Stanislaw**



**WARNING:** Cancer and  
 Reproductive Harm —  
[www.P65Warnings.ca.gov](http://www.P65Warnings.ca.gov)

Chemicals shipped domestic ground only (Lower 48 states only). No international shipping.

**Phone: (360) 816-0211 • (800) 999-CHEV (2438) • www.chevsofthe40s.com**

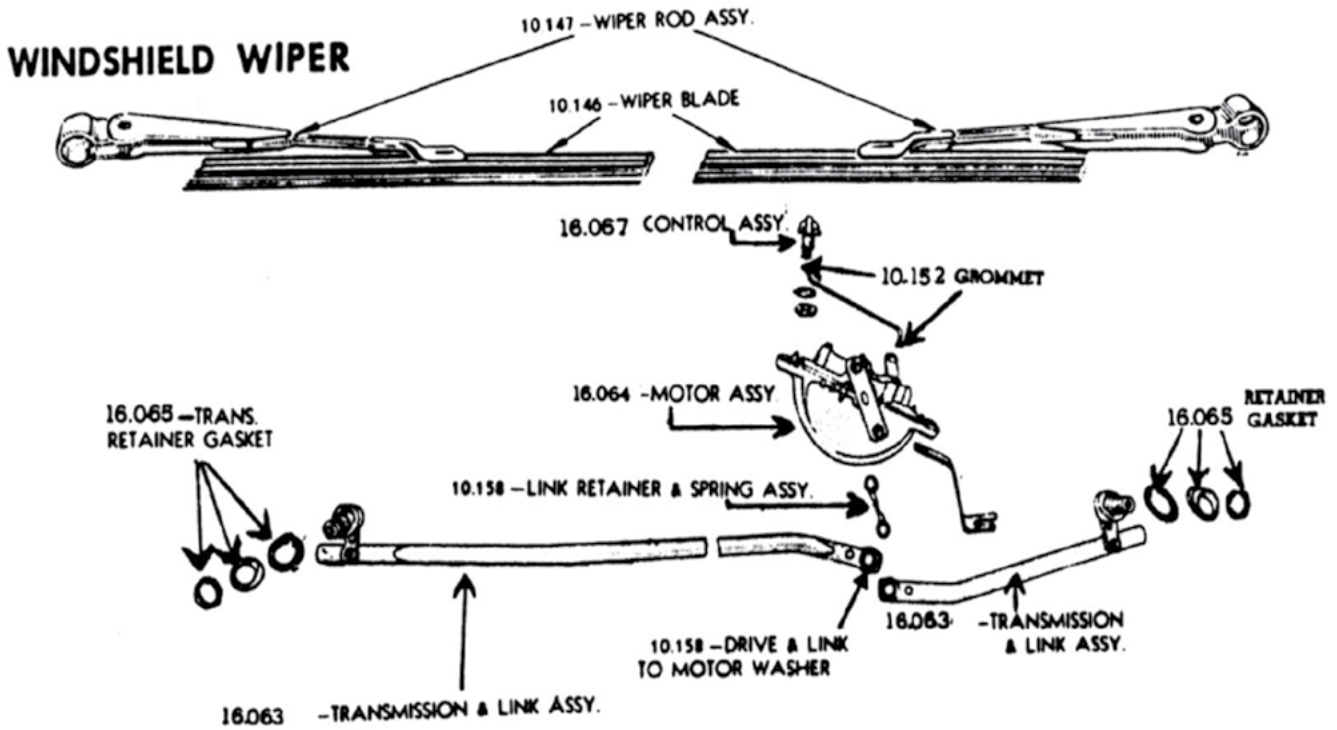

**SECTION 370T  
STREET ROD PARTS**

**Header Panel**



- 593369**.....**36-38**  
Mounts above windshield (fiberglass).  
16.562 -0.15 ..... **\$174.00 EA** ⚠
- 598772**.....**39-46**  
Mounts above windshield (fiberglass).  
16.563 -0.15  
..... **\$174.00 EA** ⚠

**Wiper Motor Access Hole Cover**



- 593351L**.....**36-38**  
Left (fiberglass). 16.563 -0.15 .....  
**\$31.00 EA** ⚠

**Wiper Motor Access Hole Cover, cont.**



- 593352R**.....**36-38**  
Right (fiberglass). 16.563 -0.15 .....  
**\$31.00 EA** ⚠

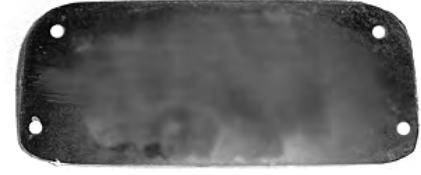

- 593353**.....**36-38**  
Blank cover for the right side wiper access  
hole made of fiberglass. 16.563 -0.15  
..... **\$23.50 EA** ⚠



- 598811L**.....**39-46**  
Left (fiberglass). 16.563 -0 .....  
**\$27.75 EA** ⚠

**Wiper Motor Access Hole Cover, cont.**



- 598813R**.....**39-46**  
Right (fiberglass). 16.563 -0 .....  
**\$27.75 EA** ⚠



- 598814**.....**39-46**  
Blank (fiberglass). 16.563 -0 .....  
**\$20.25 EA** ⚠

**Wiper Cap**



- BIS248810**.....**54**  
Billet Bullet cap  
replaces wiper arm  
on shaft. 11/16"  
or smaller shaft.  
10.159 -0.15  
..... **\$32.00 PR** ⚠

Returns require a return authorization number—call first. • Product pricing & availability subject to change.

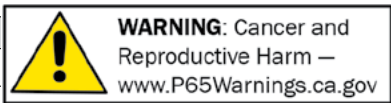

**Wiper Cap, cont.**



**4601065.....ALL**  
Wiper chrome cap replaces wiper arm on shaft. 9/16" ID  
10.159 -0.15

**\$18.00 PR** ⚠



**4601065C .....ALL**  
Wiper chrome cap replaces wiper arm on shaft. Bullet cover. 9/16" ID 10.159 -0.15

**\$18.00 PR** ⚠



**BIS248815.....ALL**  
Billet Bullet cap replaces wiper arm on shaft. 11/16" or smaller shaft.

10.159 -0.15

**\$29.75 PR** ⚠

**Wiper Motor w/ Linkage Kit**



**4089935D .....47-53**  
Chevy truck W/ linkage-12v, 2-speed w/ delay & park (replaces old cable & spool system). 10.150 -0.15

**\$525.50 EA** ⚠

**4089935S .....47-53**  
Chevy truck W/ linkage-12v, 2-speed w/ park (replaces old cable & spool system). 10.150 -0.15

**\$470.50 EA** ⚠

**Wiper Motor Electric Kit**



**598989G.....37-46**  
Chevy truck 12v, w/ arm & blade easy installation. 16.064 -0.15

**\$199.00 EA** ⚠



**598989H .....37-46**  
Chevy truck 6v, w/ arm & blade easy installation. 16.064 -0.15

**\$199.00 EA** ⚠

**Electric Wiper Motor**



**4089935M.....47-53**  
Chevy truck 2 speed & self park (6v). 16.064 -0.15

**\$198.75 EA** ⚠



**4089935N .....47-53**  
Chevy truck 2 speed & self park (12v), also fits GMC. 16.064 -0.15

**\$253.50 EA** ⚠



**3710004M ..... 54**  
Chevy truck 2 speed & self park (6v). Comes w/ original style knob. 16.064 -0.15

**\$199.00 EA** ⚠



**3710004N ..... 54**  
Chevy truck 2 speed & self park (12v), also fits GMC. 16.064 -0.15

**\$253.50 EA** ⚠



**598989E.....ALL**  
Universal. 6v. 3 3/16" Length x 1/4" Diameter. 16.064 -0.15

**\$67.00 EA** ⚠

**Electric Wiper Conversion Kit**

Clean Wipe System. Replaces factory wiper system. Comes with 12 volt, two-speed electric motor, complete with bracketing, linkage arms, wiper transmissions, wiper arms & blades, wiring and switch. Designed to fit in stock location above the windshield. For wiper delay add part #4073750D

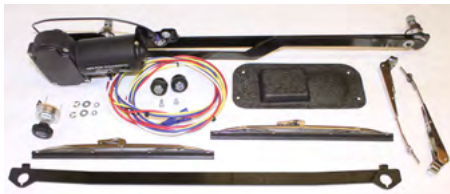

**594640KD .....37-38**  
Chevy Truck Deluxe Clean Wipe System 12v. Stainless wiper arms & blades. 16.064 -0

**\$440.00 KIT** ⚠

**Electric Wiper Conversion Kit, cont.**



**598988F.....37-46**  
Chevy Truck Intermittent-replaces motor & 2 transmissions. Quiet cable drive & motor can be mounted outside passenger compartment for quiet operation. 16.064 -0

**\$310.00 KIT** ⚠



**598989KD .....39-46**  
Chevy Truck Deluxe Clean Wipe System 12v. Stainless wiper arms & blades. 16.064 -0

**\$440.00 KIT** ⚠



**4089934E.....47-54**  
Chevy Truck, Replaces motor & 2 transmissions. Quiet cable drive & motor

can be mounted outside passenger compartment for quiet operation. 16.064 -0.15

**\$407.50 KIT** ⚠



**4089934F.....47-54**  
Chevy Truck Intermittent-replaces motor & 2 transmissions. Quiet cable drive & motor can be mounted outside passenger compartment for quiet operation. 16.064 -0.15

**\$374.00 KIT** ⚠

**Intermittent Delay Switch**



**4073750D .....ALL**  
For electric wiper motors. 10.150 -0

**\$95.00 EA** ⚠

**Hose**



**609742 .....ALL**  
1/2" I.D. Sold by the inch 3.003 -0.3

**\$0.25 IN** ⚠

**Wiper Blade**



**561094S .....55-59**  
12in. 10.146 -0.15

**\$19.00 EA** ⚠

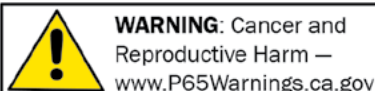

**WARNING: Cancer and Reproductive Harm** —  
www.P65Warnings.ca.gov

Chemicals shipped domestic ground only (Lower 48 states only). No international shipping.

**Phone: (360) 816-0211 • (800) 999-CHEV (2438) • www.chevsofthe40s.com**

**Wiper Blade, cont.**



**NE13006** .....**ALL**  
6" stainless wiper blade for use with  
3683910A adjustable wiper arm.  
10.146 -0.15 ..... **\$20.50 EA** ⚠



**NE13008** .....**ALL**  
8" stainless wiper blade for use with  
3683910A adjustable wiper arm.  
10.146 -0.15 ..... **\$20.50 EA** ⚠



**NE13010** .....**ALL**  
10" stainless wiper blade for use with  
3683910A adjustable wiper arm.  
10.146 -0.3 ..... **\$16.25 EA** ⚠



**NE13012** .....**ALL**  
12" stainless wiper blade for use with  
3683910A adjustable wiper arm.  
10.146 -0.3 ..... **\$16.25 EA** ⚠

**Wiper Arm**



**3683910A** .....**ALL**  
Chrome. Adjustable length and wiper  
angle, 6-11". Fits wiper transmissions with  
a 9/16" spline shaft. Use with blades  
NE130... 10.146 -0 ..... **CALL** ⚠

**3683910SA** .....**ALL**  
Stainless. Adjustable length and wiper  
angle. 6-11" Use with blades NE130...  
10.146 -0.15 ..... **CALL** ⚠

**Wiper Arm & Blade**



**603047R** .....**31-38**  
7in. stainless arm w/ 8-1/4in. blade (2  
pcs). 10.146 -0 ..... **\$51.00 EA** ⚠

**SECTION 370T  
RESTORATION PARTS**

**Fuel Pump**

Tired of your wipers stopping when you get  
on the accelerator? Replace your fuel pump  
with one that also has a vacuum pump for  
consistent wiper movement.



**5591457** ....**37-51**  
W/ vacuum pump  
(glass bowl) stops  
slow wipers, original  
accessory. Also  
fits GMC, includes  
gasket. 3.900 -0.15  
..... **CALL** ⚠



**5591457M** ..**37-51**  
W/ vacuum pump  
(metal bowl)  
includes gasket.  
3.900 -0  
..... **CALL** ⚠



**5592675** ....**52-57**  
W/ vacuum pump  
(glass bowl) stops  
slow wipers, original  
accessory. 3.900 -0.15  
..... **CALL** ⚠



**5592675M** ..**52-57**  
W/ vacuum pump  
(metal bowl) stops  
slow wipers, original  
accessory. 3.900 -0  
..... **CALL** ⚠

**Fuel Pump Rebuild Kit**



**5591844** .....**37-51**  
W/ vacuum pump 3.901 -0.15 .....  
**\$89.00 EA** ⚠



**5591825** .....**52-57**  
W/ vacuum pump 3.900 -0 ..... **\$77.25 EA**  
⚠

**Cowl Vent Knob**



**3656663A** ....**40-46**  
As original, brown.  
16.130 -0.15  
..... **\$8.75 EA** ⚠



**985603** .....**40-46**  
Ivory accessory 9.691 -0  
..... **\$15.00 EA** ⚠



**3682916A** .....**47-53**  
Side or top vent,  
maroon. 16.130 -0.15  
..... **\$7.00 EA** ⚠



**3131111** ..... **54**  
Black. Original color  
and quality. 16.130 -0.4  
..... **\$14.00 EA** ⚠

**Cowl Vent Seal**



For 15" X 3-7/8" Cowl Vent

**373398** .....**34-38**  
Non-absorbing, molded. 16.140 -0.15 .....  
**\$34.50 EA** ⚠



**3681067** .....**39-46**  
Non-absorbing, molded. 16.140 -0.15 .....  
**\$26.00 EA** ⚠



**Cowl Vent Seal, cont.**



**3681067A** .....39-46  
Sponge 16.140 -0.15 ..... **\$12.00 EA** ⚠



**3684389** .....47-50  
Side vent, non-absorb molded. 16.140 -0.3  
..... **\$13.00 EA** ⚠

**3684389A** .....47-50  
Side vent, sponge. 16.140 -0.2  
..... **\$6.25 EA** ⚠



**3682856** .....47-53  
Non-absorb molded. 16.140 -0.15  
..... **\$7.50 EA** ⚠

**3682856A** .....47-53  
Sponge 16.140 -0.15  
..... **\$6.00 EA** ⚠

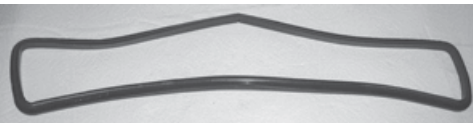

**3703560** ..... 54  
Non-absorb molded. 16.140 -0.15  
..... **\$6.50 EA** ⚠

**3703560A** ..... 54  
Sponge 16.140 -0.15  
..... **\$9.19 EA** ⚠

**Hose**

**4027764** .....39-46  
Cowl vent drain.  
16.127 -0.4  
..... **\$2.00 EA** ⚠

**3683657** .....47-54  
Cowl vent drain.  
16.127 -0.2  
..... **\$8.25 EA** ⚠

**Bolt**



**4023060** .....39-46  
Cowl vent hinge  
(shouldered bolt).  
16.135 -0.15  
..... **\$19.75 PR** ⚠

**Wiper Knob**



**3685141** .....47-49  
Chrome Chevy & GMC  
16.067 -0.4  
..... **\$6.00 EA** ⚠



**3699117** .....50-53  
Maroon Chevy & GMC,  
original color and  
quality. 16.067 -0.4  
..... **\$6.00 EA** ⚠



**3703853** ..... 54  
Black 16.067 -0.15  
..... **\$8.00 EA** ⚠

**Vacuum Hose**



**601607** .....ALL  
Wiper motor to engine,  
1/4 in. I.D. 10.155 -0.3  
..... **\$1.25 FT** ⚠

**Wiper Control Link**



**3699117A** .....47-53  
Rod 16.067 -0.15  
..... **\$3.75 EA** ⚠

**Wiper Control Link Grommet**



**4093397** .....47-53  
Wiper control link  
16.065 -0.15  
..... **\$1.75 PR** ⚠

**Windshield Washer Hose**



**604041B** .....37-50  
9 ft, w/ original GM instruction sheet &  
firewall grommet. 8.962 -0.4  
..... **\$30.75 KIT** ⚠

**Windshield Washer Nozzles**



**604354** .....40-50  
Chrome w/ mounting  
bracket. 8.798 -0  
..... **CALL** ⚠

**Hose Connector 3-way**



**3682929** .....ALL  
Y wiper & washer,  
7/32in. 16.066 -0.2  
..... **\$0.50 EA** ⚠

**Pivot Rubber Bushings**



**3746483** .....47-53  
For wiper motor  
10.158 -0.15  
..... **\$1.50 PR** ⚠

**Wiper Motor Pivot Linkage Retainer**



**4065091** .....47-53  
For wiper motor, Length 2-3/16".  
10.158 -0.15  
..... **\$2.50 EA** ⚠



**4570135** .....54-57  
For wiper motor retainer, 2-3/4" length.  
10.158 -0  
..... **\$5.00 EA** ⚠

**Vacuum Operated Wiper Motor**

\$15 shipping & handling for rebuild service.

**SPECIFYALL** .....ALL  
Rebuild yours (please send motor only-do  
not send any other parts) 10.150 -0.15  
..... **\$176.00 EA** ⚠

**Wiper Blade**



**985459** .....29-46  
8-1/2in. 10.146 -0.15  
..... **\$5.00 EA** ⚠



**985982** .....39-46  
9in. 10.146 -0.3  
..... **\$6.25 EA** ⚠



**3683905** .....47-53  
10in. 10.146 -0.3  
..... **\$11.50 EA** ⚠

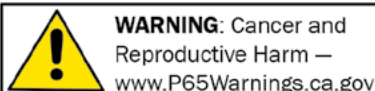

**WARNING:** Cancer and  
Reproductive Harm —  
www.P65Warnings.ca.gov

Chemicals shipped domestic ground only (Lower 48 states only). No international shipping.

**Phone: (360) 816-0211 • (800) 999-CHEV (2438) • www.chevsofthe40s.com**

370T

**Wiper Blade, cont.**



**3683905S** .....**.54-55**  
 10in. Stainless Steel. 10.146 -0.15 .....  
**\$12.00 EA** ⚠

**Wiper Arm**



**603047**.....**.31-38**  
 7in. stainless arm 10.147 -0.15 .....  
**\$19.50 EA** ⚠



**598991**.....**.39-46**  
 Stainless 10.147 -0.3 ..... **\$23.75 EA** ⚠



**3697280** .....**.47-53**  
 Left 10.147 -0.2 ..... **\$20.00 EA** ⚠



**3697282** .....**.47-53**  
 Right 10.147 -0.2 ..... **\$20.00 EA** ⚠



**3722488** .....**.54-59**  
 Right 10.147 -0.2 ..... **\$17.00 EA** ⚠



**3730483** .....**.54-59**  
 Left 10.147 -0.2 ..... **\$17.00 EA** ⚠

**Wiper Transmission & Link Assembly**



**3683915B** .....**.47-53**  
 Like original. 16.063 -0.15 .....  
**\$134.00 L&R** ⚠



**3703856B** .....**.54-55**  
 54-55 (1st Series). 16.063 -0.15 .....  
**\$127.00 L&R** ⚠

**Gasket**



**593383** .....**.36-38**  
 Wiper motor bezel to cab 16.065 -0.3 .....  
**\$1.75 EA** ⚠



**598993** .....**.39-46**  
 Wiper motor bezel to cab 16.065 -0.2 .....  
**\$1.25 EA** ⚠



**3685793A** .....**.47-53**  
 Wiper transmission 16.065 -0.15 .....  
**\$1.75 PR** ⚠



**3703860A** ..... **54**  
 Wiper transmission 16.065 -0.3 .....  
**\$5.25 PR** ⚠

**Chrome Bezel**



**593384**.....**.36-38**  
 Wiper transmission 16.065 -0.15 .....  
**\$26.75 EA** ⚠



**598994**.....**.39-46**  
 Wiper transmission 16.065 -0 .....  
**CALL** ⚠



**3683911**.....**.47-53**  
 Wiper transmission 16.065 -0.15 .....  
**\$14.00 PR** ⚠



**3703859**..... **54**  
 Wiper Transmission 16.065 -0.15 .....  
**\$13.25 SET** ⚠

**Nuts**



**3683913**.....**.47-59**  
 Retains chrome wiper bezel to cowl 16.065 -0.15 .....  
**\$5.00 PR** ⚠

**Odds & Ends**

Please call for availability on all Odds & Ends parts; once part is sold, it may no longer be in stock.

**3683915U** .....**.47-53**  
 Wiper trans link left hand (Used) 16.063 -0 .....  
**\$10.00 EA** ⚠





ILLUSTRATIONS ARE COMPLETE ASSEMBLIES.  
SEE TEXT FOR AVAILABILITY.

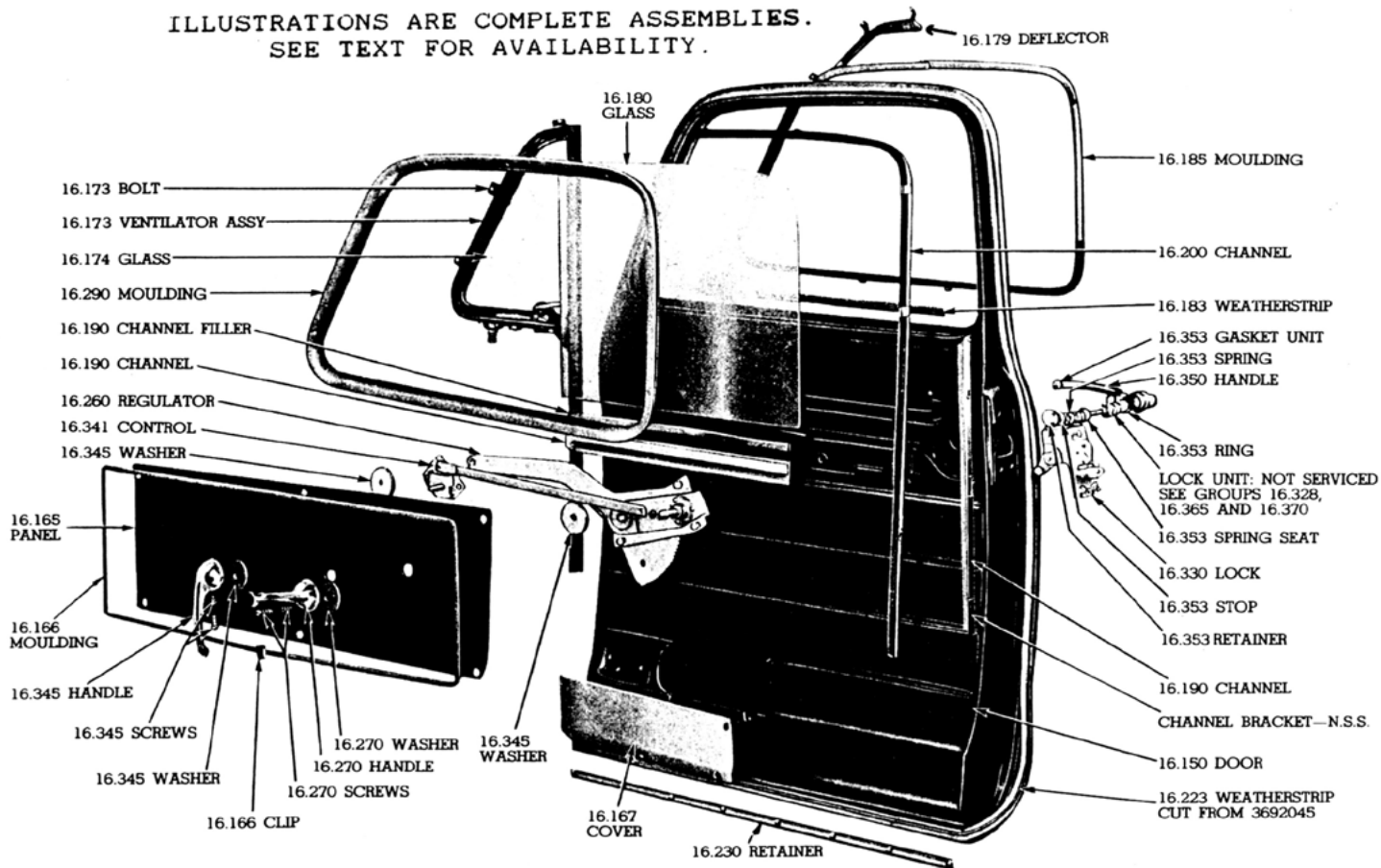

**1951-53 CONVENTIONAL CAB DOOR ASSEMBLY**

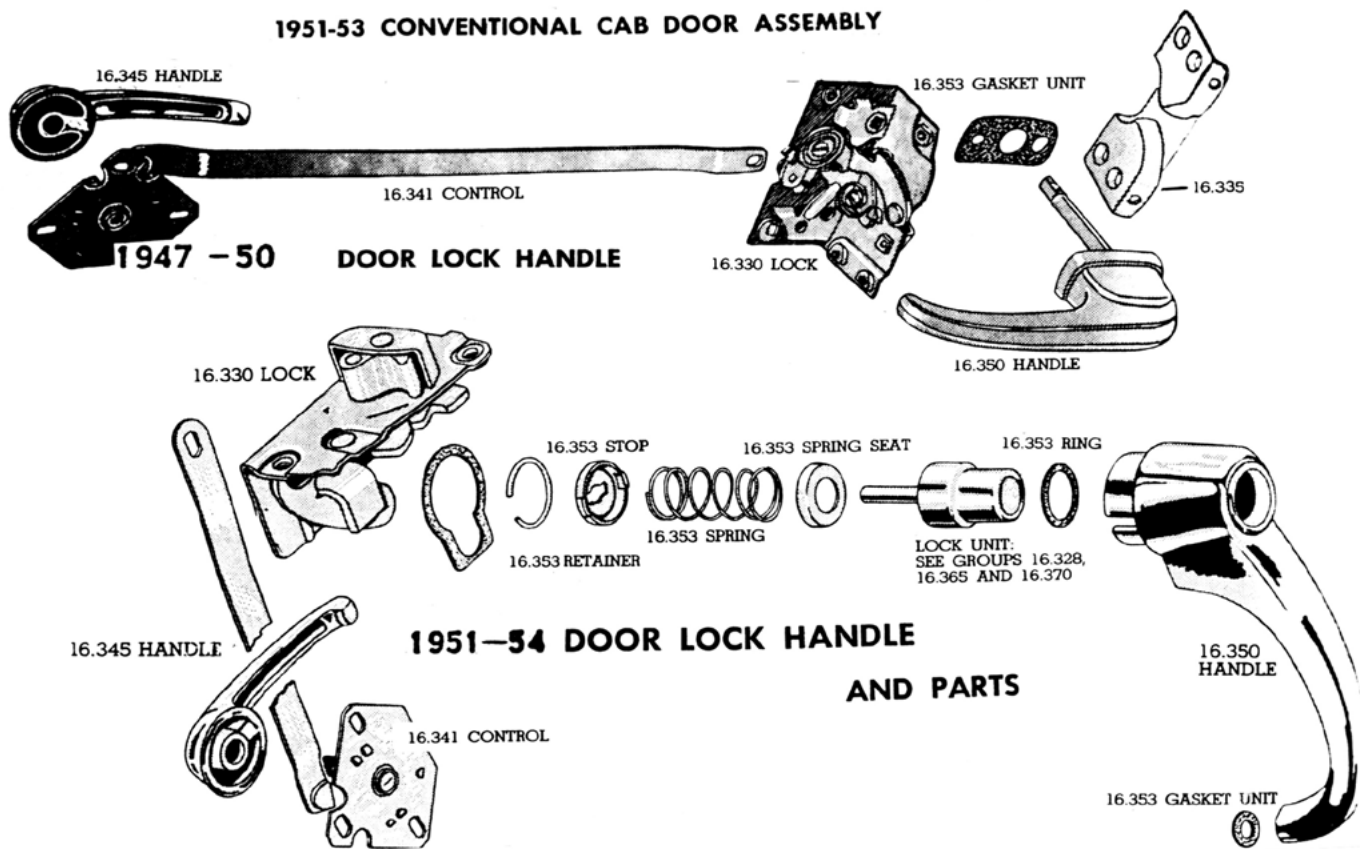

**1947 - 50 DOOR LOCK HANDLE**

**1951-54 DOOR LOCK HANDLE AND PARTS**



**WARNING:** Cancer and Reproductive Harm — [www.P65Warnings.ca.gov](http://www.P65Warnings.ca.gov)

Chemicals shipped domestic ground only (Lower 48 states only). No international shipping.

Phone: (360) 816-0211 • (800) 999-CHEV (2438) • [www.chevsofthe40s.com](http://www.chevsofthe40s.com)

**SECTION 380T  
STREET ROD PARTS**

**Clutch Head Driver**

For individual clutch head bits, see Section 15T.



**DRIVER.....ALL**  
Magnetic clutch head driver, Chev's imprint. w/ 5 bits (1/8 in., 5/32 in., 3/16 in., 1/4 in., 5/16 in.) 8.821-0 .....  
**\$22.25 SET** ⚠️

**Clutch Head Socket Set**



**CHSS-4.....ALL**  
4 pc. 3/8 Drive. Includes 5/16", 1/4", 3/16", 5/32" sockets. 8.821-0.15 .....  
**\$20.50 SET** ⚠️

**SECTION 380T  
RESTORATION PARTS**

Note: Window Cranks see Section 460T.

**Door Panels Aluminum**



**4754DP.....47-54**  
Aluminum Door Panels are a replacement part for the original cardboard door panels. Made from 20 gauge aluminum these door panels mount with screws in the factory location. -0 .....  
**\$140.00 L&R** ⚠️

**Door Lock Knobs**



**DLK70023.....ALL**  
8 Ball Door Lock Knob -0.15 .....  
**\$7.50 PR** ⚠️

**Door Lock Knobs, cont.**



**DLK70044.....ALL**  
Chrome Metal Tube  
Door Lock Knob -0.2 .....  
**\$7.25 PR** ⚠️

**Door Handle Exterior**

**474991.....34-38**  
Non-locking. LH 16.360-0.15 .....  
**\$60.00 EA** ⚠️



**3654589.....39-46**  
Non-locking. Chrome finish. 16.360-0.15 .....  
**\$40.75 EA** ⚠️



**3654589NC.....39-46**  
Non-locking. Paintable finish 16.360-0  
**CALL** ⚠️



**3686255.....47-51**  
Left & right 16.360-0.15 .....  
**\$67.25 PR** ⚠️



**5254BDH.....52-54**  
GM / Chevy Billet Door Handles -0 .....  
**\$350.00 L&R** ⚠️



**3698881.....52-59**  
Non-locking pushbutton (left side) & right side w/o pushbutton (install yours or use our pt #3700318). 16.350-0.15 .....  
**\$69.00 PR** ⚠️

**Pushbutton**



**3700318.....52-59**  
For right side door handle w/ lock cylinder & 2 keys. 16.365-0.15 .....  
**\$44.00 EA** ⚠️

**Door Handle Exterior Return Spring**



**3683067A.....39-46**  
Left 16.330-0.15 .....  
**\$6.50 EA** ⚠️

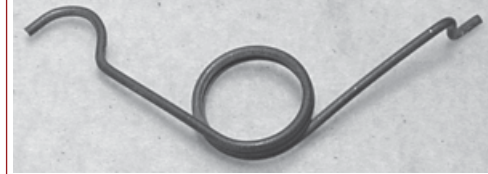

**3683068.....39-46**  
Right 16.330-0.15 .....  
**\$6.50 EA** ⚠️



**3684168.....47-51**  
Exterior 16.330-0.15 .....  
**\$6.00 EA** ⚠️

**Door Handle Exterior Guard**



**3698881C.....52-59**  
Chrome 16.350-0.15 .....  
**\$22.50 PR** ⚠️

**Door Handle Exterior Gasket**



**603954A.....47-51**  
Door handle & lock (exterior). 16.353-0.15 .....  
**\$6.00 SET** ⚠️



**3700098.....52-59**  
Door handle (exterior). 16.353-0.15 .....  
**\$2.00 SET** ⚠️

# Section 380T: Door Handles, Armrests, Door Latches & Strikers

## Screw Set

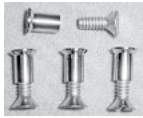

**3694071.....47-50**  
Attaches upper and lower door frame glass.  
16.190 -0.15  
..... **\$5.00 SET** ⚠



**4147641A.....47-51**  
Door handle bezel (exterior) (4 pcs).  
16.270 -0.15  
..... **\$3.75 SET** ⚠



**3684161A.....47-53**  
Door panel, cardboard, does both doors (12 pcs). 16.290 -0.4  
..... **\$3.00 SET** ⚠



**3684481B.....47-54**  
Window garnish mouldings, 2 doors.  
16.290 -0.3  
..... **\$6.00 SET** ⚠



**3694284B.....47-54**  
Headliner, door panel, window & windshield garnish mouldings. 16.290 -0.4  
..... **\$17.50 KIT** ⚠

## Door Lock



**3684820.....47-53**  
W/ 2 keys, exterior 47-51 right door, also Panel & Suburban.  
Will fit late 1942-46 by shortening the shaft and flattening one corner. 16.328 -0  
..... **\$55.00 EA** ⚠

## Retainer



**3676359.....47-51**  
For door lock cylinder. 16.328 -0.15  
..... **\$7.50 EA** ⚠

## Door Lock Gasket



**1393155A.....42-46**  
Key (exterior).  
16.328 -0.15  
..... **\$1.50 EA** ⚠

## Key Blank



**601272.....35-54**  
Original GM round head. Fits trunk, glove box & locking gas cap  
2.187 -0.2  
..... **\$4.00 EA** ⚠



**3694624.....35-57**  
Original GM octagon head. Fits ignition, door & spare tire locks.  
2.187 -0.15  
..... **\$2.50 EA** ⚠

## Door Lock Knob

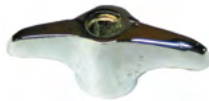

**3654592.....34-40**  
Small Chrome T-handle. 3/16" square hole. 16.392 -0.15  
..... **\$13.75 EA** ⚠



**3658537.....41-46**  
Small chrome t-handle. 1/4" square hole. 16.390 -0.15  
..... **\$13.00 EA** ⚠

## Door Latch Striker

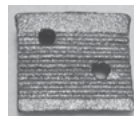

**598777A.....39-46**  
Replacement.  
16.335 -0.15  
..... **\$31.75 EA** ⚠



**3684235B.....47-51**  
Zinc finish 16.335 -0.15  
..... **\$24.00 PR** ⚠

## Door Latch Striker, cont.



**3753185B.....52-59**  
Zinc finish 16.335 -0.15  
..... **\$28.50 PR** ⚠

## Door Dovetail Plate



**474884.....37-46**  
Dovetail Wedge plate welds onto door  
16.420 -0.15  
..... **\$17.50 EA** ⚠

## Door Dovetail Rubber Bumper



**3681079.....37-46**  
2 rubber bumpers w/ metal caps. 2 pairs required per truck. 16.400 -0.15  
..... **\$29.75 PR** ⚠

## Door Latch Assembly



**3684166.....47-51**  
Right 16.335 -0.15  
..... **\$34.50 EA** ⚠

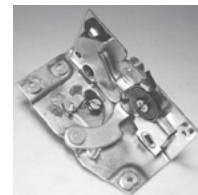

**3684167.....47-51**  
Left 16.335 -0.15  
..... **\$34.50 EA** ⚠

**TRQ-AEL07.....47-51**  
Altman easy latch set for Chevy trucks. Replace factory door latch assemblies with modern style latching mechanisms.  
16.335 -0.15  
..... **\$350.50 SET** ⚠

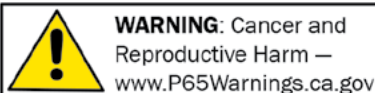

Chemicals shipped domestic ground only (Lower 48 states only). No international shipping.

Phone: (360) 816-0211 • (800) 999-CHEV (2438) • www.chevsofthe40s.com

**Door Latch Assembly, cont.**



**3698813** ..... **52-54**  
Left 16.335 -0.15 ..... **\$55.75 EA** ⚠

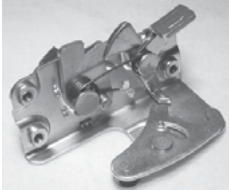

**3698814** ..... **52-54**  
Right 16.335 -0.15 ..... **\$51.25 EA** ⚠  
**TRQ-AE08** ..... **52-54**  
Altman Easy Latch set. Replace factory door latch assemblies, with modern style latching mechanisms. 16.335 -0.15 ..... **\$350.50 SET** ⚠

**Latch Repair**

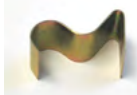

**3684167R** ..... **47-63**  
Repair spring  
16.335 -0.15 ..... **\$5.00 EA** ⚠

**Clutch Head Screw Set**



**3707583A** ..... **47-51**  
Latch assembly to door (does both doors). 8pcs  
16.270 -0 ..... **\$10.00 SET** ⚠



**3707583** ..... **52-54**  
Latch assembly to door (does both doors). 6pcs  
16.270 -0.15 ..... **\$6.25 SET** ⚠



**4147641C** ..... **52-54**  
Door latch striker (does both doors) (8 pcs). Uses 3/16" bit.  
16.270 -0.3 ..... **\$6.25 EA** ⚠

**Ferrule**



**4003748** ..... **29-38**  
Chrome, w/ grommet, door handle. 10.537 -0 ..... **\$7.50 EA** ⚠



**4082056** ..... **39-46**  
Chrome, w/ grommet, door handle. 10.537 -0.4 ..... **\$15.25 EA** ⚠

**Rubber Grommet**



**4125630A** ..... **39-46**  
Door handle ferrule.  
10.537 -0 ..... **\$7.00 EA** ⚠

**Ferrule Tool**



**4088134A** ..... **ALL**  
Installs door handle ferrules. Return tool in same condition as sent for a \$20 refund. Does not fit with 4125630  
10.537 -0.15 ..... **\$46.00 EA** ⚠

**Door Handle Interior**



**373434B** ..... **34-38**  
Chrome. 16.345 -0.15 ..... **\$36.50 EA** ⚠



**3654593** ..... **39-46**  
Unplated, military army green color (NOS).  
16.345 -0.15 ..... **\$25.00 EA** ⚠



**3654593C** ..... **39-46**  
Chrome interior door handle. 16.345 -0.15 ..... **\$33.00 EA** ⚠



**3848873** ..... **47-66**  
This is a chrome interior door handle.  
16.345 -0.15 ..... **\$14.00 EA** ⚠

**Door Handle Interior Gasket**



**3686114B** ..... **47-54**  
Interior door & window handles with door panel spacers (12pcs).  
16.345 -0.15 ..... **\$12.75 SET** ⚠

**Screws**



**3654595** ..... **36-46**  
Window crank and interior door handle retaining screw 16.270 -0.15 ..... **\$4.75 EA** ⚠



**3683258** ..... **47-53**  
Retains original GM interior handles.  
16.270 -0.15 ..... **\$7.50 PR** ⚠



**4147641B** ..... **47-54**  
Clutch head, attaches the interior door handle remote to the door (6 pcs). 16.341 -0.15 ..... **\$6.25 SET** ⚠

**Return Spring**



**3661465B** ..... **39-46**  
Both handles 16.342 -0.15 ..... **\$13.25 PR** ⚠



**3698879** ..... **47-54**  
Fits remote for interior handle. 16.342 -0.15 ..... **\$10.00 EA** ⚠

**Remote w/ Linkage**



**598912** ..... **39-46**  
Metal link fits inside door, connects latch to inside handle. Fits left or right. Also fits GMC -0 ..... **\$12.75 EA** ⚠



**3698877** ..... **47-55**  
Left side for inside handle (original 52-55).  
16.341 -0.15 ..... **\$22.00 EA** ⚠

**3698878** ..... **47-55**  
Right side for inside handle (original 52-55). 16.341 -0.15 ..... **\$20.50 EA** ⚠

# Section 380T: Door Handles, Armrests, Door Latches & Strikers

## Door Arm Rests



**986154** ..... **.47-54**  
Brown (super!) 16.155 -0.15 ..... **\$45.25 EA** ⚠️

**986154D** ..... **.47-54**  
Black (super!) 16.155 -0.15 ..... **\$41.50 EA** ⚠️

**986154M** ..... **.47-54**  
Maroon. As original, Superb! 6" mounting holes (center-to-center). 16.155 -0.15 ..... **\$51.25 EA** ⚠️

## Arm Rest Rubber Pad



**3684360** ..... **.47-54**  
Pad only 16.155 -0.15 ..... **\$24.75 EA** ⚠️

## Arm Rest Bracket



**3684383** ..... **.47-54**  
Black, plastic. 16.155 -0.15 ..... **\$30.75 EA** ⚠️

**3684384** ..... **.47-54**  
Brown 16.155 -0.15 ..... **\$28.25 EA** ⚠️

## Metal Trim Plate

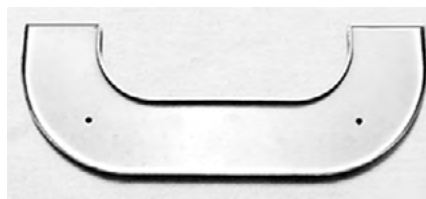

**3684383A** ..... **.47-54**  
For arm rest. 16.155 -0.15 ..... **\$14.00 EA** ⚠️

## Odds & Ends

Please call for availability on all Odds & Ends parts; once part is sold, it may no longer be in stock.

**598907** ..... **.39-46**  
Door Lock Remote 16.341 -0.4 ..... **\$35.00 EA** ⚠️

**3684166U** ..... **.47-51**  
Door latch assembly, used fits right hand 16.335 -0.4 ..... **\$30.00 EA** ⚠️

**3848873U** ..... **.47-66**  
Door handle (Used) 16.345 -0 ..... **\$15.00 EA** ⚠️

**3695977** ..... **.51-54**  
Interior window moulding stainless steel (left) used in good condition 16.290 -0.4 ..... **\$45.00 EA** ⚠️



**1954 GMC – Kevin Staal**



**WARNING:** Cancer and Reproductive Harm – [www.P65Warnings.ca.gov](http://www.P65Warnings.ca.gov)

Chemicals shipped domestic ground only (Lower 48 states only). No international shipping.

**Phone: (360) 816-0211 • (800) 999-CHEV (2438) • [www.chevsofthe40s.com](http://www.chevsofthe40s.com)**

**SECTION 390T  
RESTORATION PARTS**

**Door Hinges**

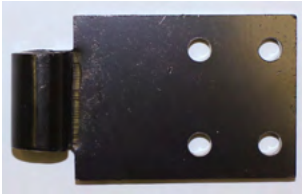

**600211A** .....**37-38**  
Upper or lower. Fits left or right. Attaches to the cab post. 16.320 -0.15 **\$33.25 EA** ⚠



**603344** .....**39-46**  
Lower w/ attaching bolts and pins. Fits left or right. 16.320 -0.15 **\$46.00 EA** ⚠



**603345** .....**39-46**  
Upper w/ attaching bolts and pins. Fits left or right. 16.320 -0.15 **\$45.00 EA** ⚠



**3847527B** .....**47-55**  
Left, upper & lower hinges (47-53 & 54-55 1st Series). Exc. COE 16.320 -0.15 **\$155.00 SET** ⚠



**3847528B** .....**47-55**  
Right, upper & lower hinges (47-53 & 54-55 1st Series). Exc. COE 16.320 -0.15 **\$155.00 SET** ⚠

**Door Hinge Bolt**

**6033446** .....**39-46**  
Door hinge Bolts 3 fine thread and 3 coarse thread. Fits Chevrolet and Gmc -0



..... **\$3.75 EA** ⚠  
**3847527A** .....**47-55**  
Includes star lock washer. 6 per hinge needed. -0.4 **\$1.25 EA** ⚠

**Hinge Seal**



**3807777** .....**47-55**  
Back door, Panel & Suburban (4 pcs). 16.325 -0.15 **\$34.50 SET** ⚠

**Hinge Pin**



**598653** .....**29-46**  
2-5/8" long 16.323 -0.2 **\$2.00 EA** ⚠



**598653A** .....**29-46**  
For Accessory Mirror. 3" long, .276" dia. 16.323 -0.2 **\$6.50 EA** ⚠



**598653S** .....**29-46**  
Stainless steel. 16.323 -0.15 **\$4.00 EA** ⚠



**4023559B** .....**39-54**  
Pin w/ bushings. Fits back door on Suburban & Panel (3 pcs). 10.466 -0 **CALL** ⚠



**3847685** .....**47-54**  
1/8in. Oversize. 16.323 -0.3 **\$2.75 EA** ⚠

**Door Strap Check Bracket**



**596409** .....**39-46**  
Replaces original which is normally rusted & broken. 16.440 -0.15 **\$25.50 EA** ⚠

**Door Check Link Assembly**



**3681747** .....**39-46**  
W/ rubber, pin & spring. 16.430 -0.15 **CALL** ⚠

**Door Check Link Springs**



**3690447** .....**47-54**  
These are door check link springs for the upper hinge. 16.323 -0.15 **\$7.25 PR** ⚠

**Check Link Bumper**



**3711312** .....**47-59**  
Back door (Panel & Suburban) 16.430 -0.15 **\$36.75 PR** ⚠

**Odds & Ends**

Please call for availability on all Odds & Ends parts; once part is sold, it may no longer be in stock.

**3688764U** .....**47-55**  
Hinge. Door, right upper (Used) exc COE. 16.320 -0.4 **\$40.00 EA** ⚠

**SECTION 400T  
RESTORATION PARTS**

**Door Windlace**



- 3847443** ..... **36-49**  
Black rubber 16.225 -0.2     **\$60.00 PR** ⚠
- 3681081G** ..... **37-40**  
Grey vinyl covered 16.225 -0     **CALL** ⚠
- 3681081K** ..... **37-40**  
Black vinyl covered 16.225 -0.15  
..... **\$45.75 PR** ⚠
- 3681081N** ..... **37-40**  
Brown vinyl covered 16.225 -0.15  
..... **\$45.75 PR** ⚠



- 3653999** ..... **41-46**  
Brown vinyl covered. 120" per side.  
16.225 -0.15     **\$43.75 PR** ⚠
- 3681082** ..... **41-46**  
Black vinyl covered. 120" per side.  
16.225 -0.15  
..... **\$46.25 PR** ⚠
- 3681082G** ..... **41-46**  
Grey vinyl covered. 120" per side.  
16.225 -0  
..... **CALL** ⚠
- 3692458** ..... **50-54**  
Grey tan rubber 16.225 -0.15  
..... **\$39.50 PR** ⚠



- 3692458A** ..... **50-54**  
Black rubber 16.225 -0.3     **\$83.50 PR** ⚠

**Windlace Retainer**



**599595** ..... **36-46**  
On hinge post between dash and floor. Left and Right. Also fits GMC

- 16.230 -0  
..... **\$22.25 PR** ⚠

**Windlace Retainer, cont.**



- 3685651B** ..... **50-55**  
Left side, door. 3 pcs. 16.230 -0.15  
..... **\$81.00 EA** ⚠



- 3685652B** ..... **50-55**  
Right side, door. 3 pcs. 16.230 -0.15  
..... **\$81.00 EA** ⚠

**Door Sill Seal**



- 3681212** ..... **37-46**  
Attaches to cab, black (6 foot length)  
16.225 -0.15     **\$28.75 EA** ⚠



- 3676019** ..... **47-49**  
Attaches to cab, black  
16.225 -0.15  
..... **\$13.00 SET** ⚠



- 3700547** ..... **50-54**  
Attaches to cab, grey/  
brown 16.225 -0.15  
..... **\$18.00 PR** ⚠



- 3700548** ..... **50-54**  
Attaches to cab (black)  
16.225 -0.15  
..... **\$10.25 PR** ⚠



- 3700548B** ..... **50-55**  
Attaches to cab, dark  
blue, original 54-55  
Deluxe cab 16.225 -0.15  
..... **\$21.50 PR** ⚠



- 3700548G** ..... **50-55**  
Attaches to cab, dark  
green, original 54-55  
Deluxe cab 16.225 -0.15  
..... **\$21.50 PR** ⚠

**Door Sill Seal Retainer**



- 3683660** ..... **47-49**  
Steel (door sill seal) on cab. 16.230 -0.15  
..... **\$15.00 EA** ⚠



- 3683660S** ..... **47-49**  
Stainless (door sill seal) on cab.  
16.230 -0.15     **\$33.75 EA** ⚠



- 3683660BA** ..... **47-53**  
Polished billet aluminum door sill seal, on  
cab (33-1/4"). 16.230 -0.15     **\$120.25 PR**  
⚠



- 3693500** ..... **50-54**  
Steel (door sill seal) on cab. 33-5/8" long.  
16.230 -0.15     **\$21.75 PR** ⚠



- 3693500S** ..... **50-54**  
Stainless (door sill seal) on cab. 33-5/8"  
long. 16.230 -0.2     **\$64.25 SET** ⚠

**Screws**



- 3654597** ..... **47-49**  
Door sill metal retainer  
(16 piece) 16.231 -0.4  
..... **\$4.75 SET** ⚠



- 3654598** ..... **50-54**  
Door sill metal retainer  
(8 pieces) 16.231 -0.4  
..... **\$2.50 SET** ⚠

**Door Weatherstrip**



- 3700548A** ..... **37-54**  
Original 47-54, does 2 doors 16.225 -0.3  
..... **\$35.00 PR** ⚠



Chemicals shipped domestic ground only (Lower 48 states only). No international shipping.

**Phone: (360) 816-0211 • (800) 999-CHEV (2438) • www.chevsofthe40s.com**

# Section 400T: Door Bumpers, Windlace & Weatherstrip

## Door Weatherstrip, cont.



**4143075A** .....**39-46**  
Panel. For both rear doors 10.694-0  
**CALL** ⚠️



**3700548A** .....**47-54**  
Panel & Suburban, does rear 2 doors  
16.225-0.3 ..... **\$34.50 PR** ⚠️

## Metal Retainer



**3691189** .....**47-54**  
Weatherstrip on door bottom (original  
50-59) 16.230-0.15 ..... **\$18.00 SET** ⚠️



**3691189S** .....**47-54**  
Weatherstrip on door bottom (original  
50-59) stainless steel with dull finish  
16.230-0.15 ..... **\$28.00 PR** ⚠️

## Weatherstrip Clips



**4076045** .....**41-54**  
Retains back door weatherstrip. Fits Panel  
& Suburban (5 pcs) 10.695-0 .....  
**\$3.25 SET** ⚠️

## Adhesives & Sealers



**511114** .....**ALL**  
3M, Black weatherstrip cement, 5-oz tube.  
Superior product!. 8.800-0.2 .....  
**\$20.00 EA** ⚠️

## Door Bumper



**3681070** .....**30-46**  
Door hinge post, 1in. x 1/4in. thick, held  
by screw (2 pcs). 16.400-0.15 .....  
**\$9.00 SET** ⚠️



**3681078** .....**36-46**  
Door jamb, rear. 5/8in. x 7/8in. x  
1-7/16in. (41-46 uses 4). 16.400-0.4  
**\$5.00 EA** ⚠️



**3684752B** .....**47-54**  
Door jamb, rear (4 pcs). 3/4" dia  
16.400-0.3 ..... **\$4.00 SET** ⚠️

## Dovetail Bumper



**3807343** .....**47-55**  
Bumper, left, back door. Panel, Suburban  
(use with old casings). 16.405-0.15 .....  
**\$21.25 EA** ⚠️





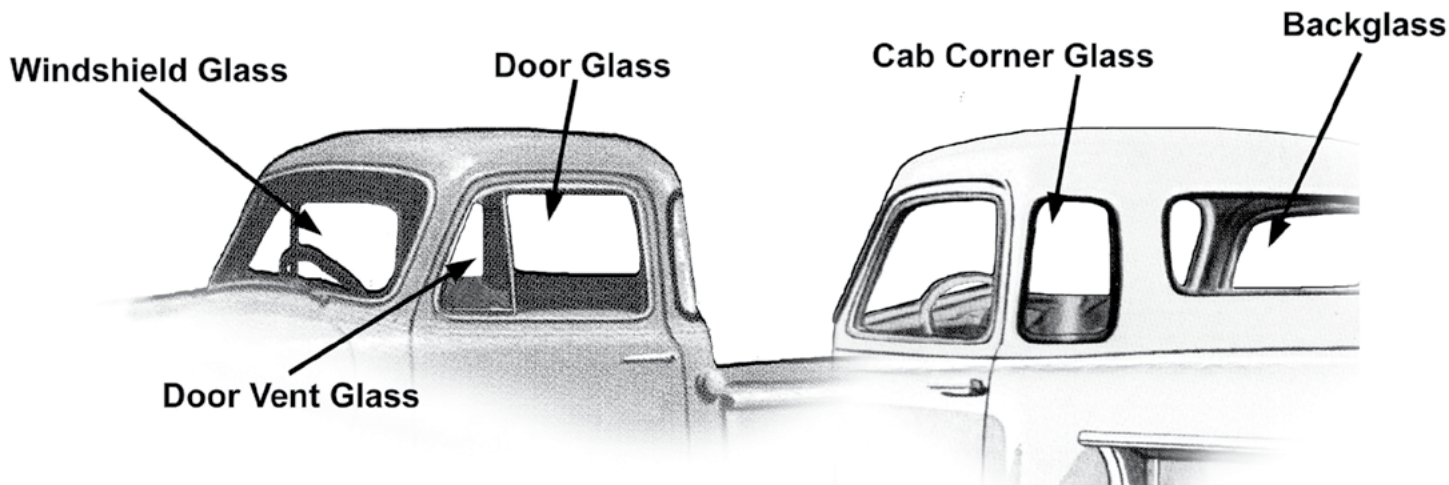

**SECTION 420T  
STREET ROD PARTS**

**One Piece V-Bent Windshield Glass**

Give your truck that clean, customized look with a one piece windshield. No more messy silicone sealing the center seam found on V-Butt windshields. All V-Bent windshields come with rubber seal.



- 1021V** ..... **39-46**  
Clear. 16.005 -0.15 ..... **\$399.00 EA** ⚠
- 1021VCS** ..... **39-46**  
Clear w/ shaded top. 16.005 -0.15 ..... **\$440.00 EA** ⚠
- 1021VT** ..... **39-46**  
Tinted Green. 16.005 -0.15 ..... **\$420.00 EA** ⚠
- 1021VTS** ..... **39-46**  
Tinted w/ shaded top. 16.005 -0.15 ..... **\$440.00 EA** ⚠
- 4235V** ..... **47-53**  
Clear. 10.027 -0.15 ..... **\$480.00 EA** ⚠
- 4235VCS** ..... **47-53**  
Clear w/ shaded top. 10.027 -0.15 ..... **\$449.99 EA** ⚠
- 4235VG** ..... **47-53**  
Tinted grey. 10.027 -0.15 ..... **\$540.00 EA** ⚠
- 4235VGS** ..... **47-53**  
Tinted grey w/ shaded top. 10.027 -0.15 ..... **\$560.00 EA** ⚠

**One Piece V-Bent Windshield Glass, cont.**

- 4235VT** ..... **47-53**  
Tinted green 10.027 -0.15 ..... **\$430.00 EA** ⚠
- 4235VTS** ..... **47-53**  
Tinted green w/ shaded top. 10.027 -0.15 ..... **\$460.00 EA** ⚠

**Back Glass & Frame**

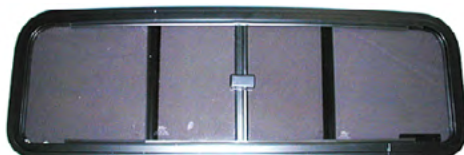

- 3704319C** ..... **47-54**  
Slider, with snap closer. Smoke tinted glass. Black frame. 16.464 -0.15 ..... **\$169.25 EA** ⚠

**SECTION 420T  
RESTORATION PARTS**

**Windshield Glass**

Note: Oversize shipping charges apply on all windshields. Please call for rate.

Note: Windshield glass dark tint unavailable. All glass is custom made. \$7 packaging fee.

- 985** ..... **37-38**  
Clear 16.005 -0.15 ..... **\$100.00 EA** ⚠
- 985G** ..... **37-38**  
Tinted Grey 16.005 -0.15 ..... **\$118.00 EA** ⚠
- 985GS** ..... **37-38**  
Tinted Grey with a shaded top 16.005 -0.15 ..... **\$132.00 EA** ⚠

**Windshield Glass, cont.**

- 985S** ..... **37-38**  
Tinted Green w/ shaded top. 16.005 -0.15 ..... **\$110.00 EA** ⚠
- 985T** ..... **37-38**  
Tinted Green 16.005 -0.15 ..... **\$100.00 EA** ⚠
- 1021** ..... **39-46**  
Clear. Sold as each. 16.005 -0.15 ..... **\$62.50 EA** ⚠
- 1021G** ..... **39-46**  
Tinted grey. Sold as a pair. 16.005 -0.15 ..... **\$144.00 PR** ⚠
- 1021GS** ..... **39-46**  
Tinted grey with shaded top. Sold as a pair. 10.027 -0.15 ..... **\$160.00 PR** ⚠
- 1021S** ..... **39-46**  
Tinted Green with shaded top. Sold as a pair. 10.027 -0.15 ..... **\$144.00 PR** ⚠
- 1021T** ..... **39-46**  
Tinted Green. Sold as a pair. 16.005 -0.15 ..... **\$128.00 PR** ⚠
- 4235G** ..... **47-53**  
Tinted Grey . Sold per side. 16.005 -0.15 ..... **\$72.00 EA** ⚠
- 4235GS** ..... **47-53**  
Tinted Grey with shaded top. Sold per side. 16.005 -0.15 ..... **\$160.00 PR** ⚠
- 4235S** ..... **47-53**  
Clear. Sold per side. 16.005 -0.15 ..... **\$64.00 EA** ⚠
- 4235SGG** ..... **47-53**  
Tinted Grey with shaded top. Sold per side. 16.005 -0 ..... **\$80.00 EA** ⚠



Chemicals shipped domestic ground only (Lower 48 states only). No international shipping.

**Phone: (360) 816-0211 • (800) 999-CHEV (2438) • [www.chevsofthe40s.com](http://www.chevsofthe40s.com)**

# Section 420T: Glass





## Windshield Glass, cont.

<b>4235SS</b> .....	<b>47-53</b>
Tinted Green with shaded top. Sold per side. 16.005 -0.15	
.....	<b>\$72.00 EA</b> ⚠
<b>4235ST</b> .....	<b>47-53</b>
Tinted Green. Sold per side. 16.005 -0.15	
.....	<b>\$64.00 EA</b> ⚠
<b>DW362</b> .....	<b>54</b>
Curved Clear. 1-piece windshield. 16.005 -0.15	
.....	<b>\$247.25 EA</b> ⚠
<b>DW362GS</b> .....	<b>54</b>
Tinted Grey with shaded top. 1-piece windshield. 16.005 -0.15	
.....	<b>\$291.50 EA</b> ⚠
<b>DW362S</b> .....	<b>54</b>
Tinted Green with shaded top. 1-piece windshield. 16.005 -0.15	
.....	<b>\$221.25 EA</b> ⚠

## Door Glass

<b>3907</b> .....	<b>37-38</b>
Clear 16.180 -0.15	
.....	<b>\$48.00 EA</b> ⚠
<b>3907D</b> .....	<b>37-38</b>
Tinted Grey -0.15	
.....	<b>\$52.00 EA</b> ⚠
<b>3907T</b> .....	<b>37-38</b>
Tinted Green -0.15	
.....	<b>\$48.00 EA</b> ⚠
<b>4074</b> .....	<b>39-40</b>
Clear 16.180 -0.15	
.....	<b>\$58.00 EA</b> ⚠
<b>4074D</b> .....	<b>39-40</b>
Tinted Grey -0.15	
.....	<b>\$62.00 EA</b> ⚠
<b>4074T</b> .....	<b>39-40</b>
Tinted Green -0.15	
.....	<b>\$58.00 EA</b> ⚠
<b>4084S</b> .....	<b>41-46</b>
Clear 16.180 -0.15	
.....	<b>\$54.00 EA</b> ⚠
<b>4084SD</b> .....	<b>41-46</b>
Tinted Grey -0.15	
.....	<b>\$58.00 EA</b> ⚠
<b>4084ST</b> .....	<b>41-46</b>
Tinted Green -0.15	
.....	<b>\$54.00 EA</b> ⚠
<b>4236S</b> .....	<b>47-50</b>
Clear 16.180 -0.15	
.....	<b>\$60.00 EA</b> ⚠
<b>4236SD</b> .....	<b>47-50</b>
Tinted Grey -0.15	
.....	<b>\$64.00 EA</b> ⚠
<b>4236SLSB</b> .....	<b>47-50</b>
Clear left side, w/ black frame. 16.180 -0.15	
.....	<b>\$161.00 EA</b> ⚠

## Door Glass, cont.

	<b>4236SLSC</b> .....	<b>47-50</b>
	Clear left side, w/ chrome frame. 16.180 -0.15	
	.....	<b>\$171.25 EA</b> ⚠
<b>4236SRSB</b> .....	<b>47-50</b>	
Clear right side, w/ black frame. 16.180 -0.15		
.....	.....	<b>\$176.00 EA</b> ⚠
	<b>4236SRSC</b> .....	<b>47-50</b>
	Clear right side, w/ chrome frame. 16.180 -0.15	
	.....	<b>\$171.25 EA</b> ⚠
<b>4236ST</b> .....	<b>47-50</b>	
Tinted Green -0.15		
.....	.....	<b>\$60.00 EA</b> ⚠
<b>4377S</b> .....	<b>51-54</b>	
Clear 16.180 -0.15		
.....	.....	<b>\$44.00 EA</b> ⚠
<b>4377SD</b> .....	<b>51-54</b>	
Tinted Grey -0.15		
.....	.....	<b>\$50.00 EA</b> ⚠
	<b>4377SLS</b> .....	<b>51-54</b>
	Clear left side w/ setting channel. 16.180 -0.15	
	.....	<b>\$99.00 EA</b> ⚠
	<b>4377SRS</b> .....	<b>51-54</b>
	Clear right side w/ setting channel. 16.180 -0.15	
	.....	<b>\$99.00 EA</b> ⚠
<b>4377ST</b> .....	<b>51-54</b>	
Tinted Green 16.180 -0.15		
.....	.....	<b>\$44.00 EA</b> ⚠

## Door Vent Glass

<b>2907S</b> .....	<b>51-54</b>
Clear. 16.174 -0.15	
.....	<b>\$30.00 EA</b> ⚠
<b>2907SD</b> .....	<b>51-54</b>
Tinted Grey -0.15	
.....	<b>\$34.00 EA</b> ⚠
<b>2907ST</b> .....	<b>51-54</b>
Tinted Green. -0.15	
.....	<b>\$30.00 EA</b> ⚠

## Back Glass

<b>2690</b> .....	<b>37-38</b>
Clear 16.174 -0.15	
.....	<b>\$32.00 EA</b> ⚠
<b>2690D</b> .....	<b>37-38</b>
Tinted Grey -0.15	
.....	<b>\$36.00 EA</b> ⚠
<b>2690T</b> .....	<b>37-38</b>
Tinted Green -0.15	
.....	<b>\$32.00 EA</b> ⚠

## Back Glass, cont.

<b>2839</b> .....	<b>39-42</b>
Clear for cab w/ die cast frame 16.174 -0.15	
.....	<b>\$42.00 EA</b> ⚠
<b>2839D</b> .....	<b>39-42</b>
Tinted Grey for Cab W/ Die Cast Frame. -0.15	
.....	<b>\$42.00 EA</b> ⚠
<b>2839T</b> .....	<b>39-42</b>
Tinted Green for Cab W/ Die Cast Frame. -0.15	
.....	<b>\$38.00 EA</b> ⚠
<b>2651S</b> .....	<b>42-46</b>
Clear 16.174 -0.15	
.....	<b>\$38.00 EA</b> ⚠
<b>2651SD</b> .....	<b>42-46</b>
Tinted Grey -0.15	
.....	<b>\$42.00 EA</b> ⚠
<b>2651ST</b> .....	<b>42-46</b>
Tinted Green -0.15	
.....	<b>\$38.00 EA</b> ⚠
<b>2720S</b> .....	<b>47-54</b>
Clear. 16.174 -0.15	
.....	<b>\$54.00 EA</b> ⚠
<b>2720SD</b> .....	<b>47-54</b>
Tinted Grey 16.174 -0.15	
.....	<b>\$58.00 EA</b> ⚠
<b>2720ST</b> .....	<b>47-54</b>
Tinted Green. 16.174 -0.15	
.....	<b>\$54.00 EA</b> ⚠

## Rear Corner Cab Glass (Laminated)

<b>BB57C</b> .....	<b>47-54</b>
Clear, laminated (will not fit COE) 16.174 -0.15	
.....	<b>\$180.00 PR</b> ⚠
<b>BB57G</b> .....	<b>47-54</b>
Tinted grey, laminated (will not fit COE) 16.174 -0.15	
.....	<b>\$192.00 PR</b> ⚠
<b>BB57T</b> .....	<b>47-54</b>
Tint green, laminated (will not fit COE) 16.174 -0.15	
.....	<b>\$180.00 PR</b> ⚠

## Suburban/ Panel Back Glass

<b>2689</b> .....	<b>37-38</b>
Clear 16.174 -0.15	
.....	<b>\$44.39 EA</b> ⚠
<b>2689D</b> .....	<b>37-38</b>
Grey -0.15	
.....	<b>\$57.25 EA</b> ⚠
<b>2689T</b> .....	<b>37-38</b>
Green Tint -0.15	
.....	<b>\$45.75 EA</b> ⚠
<b>2838</b> .....	<b>39-46</b>
Clear 16.174 -0.15	
.....	<b>\$30.00 EA</b> ⚠

Returns require a return authorization number—call first. • Product pricing & availability subject to change.



**WARNING:** Cancer and Reproductive Harm — www.P65Warnings.ca.gov

# Section 420T: Glass

## Suburban/ Panel Back Glass, cont.

<b>2838D</b> .....	<b>39-46</b>
Tinted Grey -0.15	
.....	<b>\$34.00 EA</b> ⚠
<b>2838T</b> .....	<b>39-46</b>
Tinted Green -0.15	
.....	<b>\$30.00 EA</b> ⚠
<b>BB59C</b> .....	<b>47-54</b>
Chevy/GMC, Suburban end lift gate, tempered, Clear -0.15	<b>\$484.09 EA</b> ⚠
<b>BB59G</b> .....	<b>47-54</b>
Chevy/GMC, Suburban end lift gate, tempered. Tinted Grey -0.15	<b>\$511.00 EA</b> ⚠
<b>BB59T</b> .....	<b>47-54</b>
Chevy/GMC, Suburban end lift gate, tempered. Tinted Green -0.15	<b>\$490.25 EA</b> ⚠
<b>DB60</b> .....	<b>47-54</b>
Panel & Suburban. Clear, left (curved). 16.174 -0.15	<b>\$110.00 EA</b> ⚠
<b>DB60G</b> .....	<b>47-54</b>
Panel & Suburban. Tint Grey, left (curved) 16.174 -0	<b>\$130.00 EA</b> ⚠
<b>DB60T</b> .....	<b>47-54</b>
Panel & Suburban. Tint Green, left (curved) 16.174 -0.15	<b>\$110.00 EA</b> ⚠
<b>DB61</b> .....	<b>47-54</b>
Panel & Suburban Clear Right (Curved) 16.174 -0.15	<b>\$110.00 EA</b> ⚠
<b>DB61G</b> .....	<b>47-54</b>
Panel & Suburban Tint Grey Right (Curved) 16.174 -0	<b>\$130.00 EA</b> ⚠
<b>DB61T</b> .....	<b>47-54</b>
Panel & Suburban Tint Green Right (Curved) 16.174 -0.15	<b>\$110.00 EA</b> ⚠

## Suburban Front Side Glass

<b>2719S</b> .....	<b>47-52</b>
Clear 17.136 -0.15	
.....	<b>\$61.00 EA</b> ⚠
<b>2719SD</b> .....	<b>47-52</b>
Tinted Grey -0.15	
.....	<b>\$62.00 EA</b> ⚠
<b>2719ST</b> .....	<b>47-52</b>
Tinted Green -0.15	
.....	<b>\$58.00 EA</b> ⚠
<b>3007SD</b> .....	<b>52-54</b>
Tinted Grey -0.15	
.....	<b>\$72.25 EA</b> ⚠
<b>3007S</b> .....	<b>53-54</b>
Clear 17.136 -0.15	
.....	<b>\$69.75 EA</b> ⚠

## Suburban Front Side Glass, cont.

<b>3007ST</b> .....	<b>53-54</b>
Tinted Green -0.15	
.....	<b>\$58.00 EA</b> ⚠
<b>Suburban Rear Side Glass</b>	
<b>4237S</b> .....	<b>47-52</b>
Clear 17.136 -0.15	
.....	<b>\$88.75 EA</b> ⚠
<b>4237SD</b> .....	<b>47-52</b>
Tinted Grey -0.15	
.....	<b>\$93.25 EA</b> ⚠
<b>4237ST</b> .....	<b>47-52</b>
Tinted Green -0.15	
.....	<b>\$74.50 EA</b> ⚠
<b>4467S</b> .....	<b>53-54</b>
Clear 17.136 -0.15	
.....	<b>\$88.75 EA</b> ⚠
<b>4467SD</b> .....	<b>53-54</b>
Tinted Grey -0.15	
.....	<b>\$93.25 EA</b> ⚠
<b>4467ST</b> .....	<b>53-54</b>
Tinted Green -0.15	
.....	<b>\$74.50 EA</b> ⚠

## Suburban Qtr Front Glass

<b>4075</b> .....	<b>39-46</b>
Clear 17.136 -0.15	
.....	<b>\$76.00 EA</b> ⚠
<b>4075D</b> .....	<b>39-46</b>
Tinted Grey -0.15	
.....	<b>\$80.00 EA</b> ⚠
<b>4075T</b> .....	<b>39-46</b>
Tinted Green -0.15	
.....	<b>\$76.00 EA</b> ⚠
 <b>2721S</b> .....	<b>47-52</b>
Clear 17.136 -0.15	
.....	<b>\$69.75 EA</b> ⚠
<b>2721SD</b> .....	<b>47-52</b>
Tinted Grey -0.15	
.....	<b>\$72.25 EA</b> ⚠
<b>2721ST</b> .....	<b>47-52</b>
Tinted Green -0.15	
.....	<b>\$58.00 EA</b> ⚠
<b>3008S</b> .....	<b>53-54</b>
Clear 17.136 -0.15	
.....	<b>\$69.75 EA</b> ⚠
<b>3008SD</b> .....	<b>53-54</b>
Tinted Grey -0.15	
.....	<b>\$72.25 EA</b> ⚠
<b>3008ST</b> .....	<b>53-54</b>
Tinted Green -0.15	
.....	<b>\$58.00 EA</b> ⚠

## Suburban Qtr Rear Glass

<b>4076</b> .....	<b>39-46</b>
Clear 17.136 -0.15	
.....	<b>\$80.00 EA</b> ⚠
<b>4076D</b> .....	<b>39-46</b>
Tinted Grey -0.15	
.....	<b>\$84.00 EA</b> ⚠
<b>4076T</b> .....	<b>39-46</b>
Tinted Green -0.15	
.....	<b>\$80.00 EA</b> ⚠
<b>4238S</b> .....	<b>47-52</b>
Clear 17.136 -0.15	
.....	<b>\$94.00 EA</b> ⚠
<b>4238SD</b> .....	<b>47-52</b>
Tinted Grey -0.15	
.....	<b>\$98.39 EA</b> ⚠
<b>4238ST</b> .....	<b>47-52</b>
Tinted Green -0.15	
.....	<b>\$79.25 EA</b> ⚠
<b>4466S</b> .....	<b>53-54</b>
Clear 17.136 -0.15	
.....	<b>\$94.00 EA</b> ⚠
<b>4466SD</b> .....	<b>53-54</b>
Tinted Grey -0.15	
.....	<b>\$98.50 EA</b> ⚠
<b>4466ST</b> .....	<b>53-54</b>
Tinted Green -0.15	
.....	<b>\$79.25 EA</b> ⚠



**WARNING:** Cancer and Reproductive Harm — [www.P65Warnings.ca.gov](http://www.P65Warnings.ca.gov)

Chemicals shipped domestic ground only (Lower 48 states only). No international shipping.

**Phone: (360) 816-0211 • (800) 999-CHEV (2438) • [www.chevsofthe40s.com](http://www.chevsofthe40s.com)**

**SECTION 430T  
RESTORATION PARTS**

**Windshield Regulator Rebuild**



**3654088** .....**36-46**  
Rebuild service, casting & metal tape must be good, exchange. 16.045 -0.15  
..... **\$299.00 EA** ⚠

**Windshield Regulator**



**475838B**.....**36-38**  
CB-238 New Casting  
Handcrafted In The  
USA -0  
..... **\$429.50 EA** ⚠

**475838R** .....**36-38**  
Rebuilt #CB-238 (\$150 core charge)  
16.045 -0.15

..... **CALL** ⚠

**598876**.....**39**  
New #CB-291 (\$100 core charge) 16.045 -0  
..... **\$429.50 EA** ⚠



**598876R** .....**39**  
Rebuilt CB-291 \$150 core charge  
16.045 -0.15 ..... **\$249.00 EA** ⚠

**3654088B** .....**40-46**  
CB-301 New Casting Handcrafted In The  
USA -0  
..... **\$429.50 EA** ⚠



**3654088R** .....**40-46**  
Rebuilt #CB-301 (\$150 core charge)  
16.045 -0.15 ..... **\$368.50 EA** ⚠

**Strap Bracket**



**475838A** .....**36-38**  
Windshield crank-out. 16.045 -0.3  
..... **\$17.00 EA** ⚠



**3653708** .....**39-46**  
Windshield crank-out, black stamped  
steel. 16.045 -0.15 ..... **\$24.50 EA** ⚠

**Windshield Crank**



**476536** .....**36-38**  
With chrome knob  
16.050 -0.15  
..... **\$40.50 EA** ⚠



**598909**.....**39**  
W/ black knob 16.050 -0.15  
..... **\$29.75 EA** ⚠



**3654631A** .....**40-46**  
W/ brown knob 16.050 -0.15  
..... **\$29.75 EA** ⚠

**Grommet**



**598986** .....**37-38**  
Grommet, windshield  
crank to dash.  
16.053 -0.15  
..... **\$1.75 EA** ⚠

**Knob**



**598910A**.....**39**  
Window or windshield  
crank. Black. 16.270 -0.15  
..... **\$14.75 EA** ⚠

**Knob, cont.**



**3654632B** .....**40-46**  
Window or windshield  
crank. Rose tan.  
16.270 -0.15  
..... **\$14.00 EA** ⚠

**Windshield Rubber Bumper**



**3681093** .....**37-46**  
Windshield Rubber Bumper 16.058 -0  
..... **\$9.25 PR** ⚠

**Windshield Divider**



**3651622** ....**39-46**  
Rubber retainer  
w/ threaded steel  
core, no moulding.  
16.017 -0.15  
..... **\$92.00 SET** ⚠



**598972D** ....**39-46**  
Windshield interior  
center divider -0.15  
..... **\$25.00 EA** ⚠

**Windshield Frame**



**602132**.....**36**  
Steel, low roof cab, special order (Super!)  
16.010 -0.15 ..... **\$419.00 EA** ⚠



**602132C** .....**36**  
Chrome, low roof cab, (Super!) 16.010 -0.15  
..... **\$845.00 EA** ⚠

**Windshield Frame, cont.**



- 602498B** ..... **37-38**  
Steel (Super!) 16.010 -0.15 .....  
**\$489.00 EA** ⚠
- 602498C** ..... **37-38**  
Chrome (Super!) 16.010 -0.15 .....  
**\$875.00 EA** ⚠

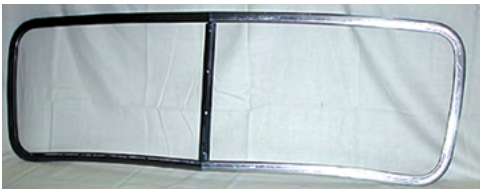

- 598972** ..... **39-46**  
Steel (Super!) 16.010 -0.15 .....  
**\$479.00 EA** ⚠
- 598972C** ..... **39-46**  
Chrome (Super!) 16.010 -0.15 .....  
**\$998.00 EA** ⚠

**Trim Clip**



- 602498A** ..... **37-38**  
Windshield frame.  
16.010 -0.15 .....  
**\$24.75 PR** ⚠

**Windshield Frame Connecting Inserts**



- 602132A** ..... **36-38**  
W/ stainless steel screws. Holds frame halves together.  
16.025 -0.2 .....  
**\$78.00 SET** ⚠



- 592329** ..... **39-46**  
W/ stainless steel screws. Holds frame halves together.  
16.025 -0.15 .....  
**\$29.00 SET** ⚠

**Windshield Moulding**



- 3676579** .... **39-46**  
Exterior. Center aluminum w/ 2 pc rubber set.  
16.017 -0.15 .....  
**\$94.50 SET** ⚠



- 3684697B** .... **47-53**  
Painted with upper & lower caps & fasteners.  
16.018 -0.15 .....  
**\$23.50 SET** ⚠



- 3684697S** .... **47-53**  
Interior. Stainless windshield division trim. 16.018 -0.15 .....  
**\$42.25 EA** ⚠



- 3684807** ..... **47-53**  
Complete set of exterior mouldings. Stainless Steel. 16.041 -0.15 .....  
**\$80.00 SET** ⚠



- 3684809** .... **47-53**  
Exterior. Stainless windshield division trim. 16.017 -0.15 .....  
**\$46.75 EA** ⚠

**Windshield Frame Seal**

- 3681322B** ..... **36-38**  
36 low roof cab, vulcanized. 16.042 -0.15 .....  
**\$43.75 EA** ⚠



- 3681322** ..... **39-46**  
Vulcanized. 16.042 -0.15 .....  
**\$47.75 EA** ⚠

**Windshield Rubber**

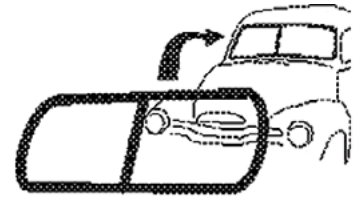

- 3684695** ..... **47-53**  
For mouldings. 16.040 -0.3 .....  
**\$100.00 EA** ⚠



- 3684802** ..... **47-53**  
Without mouldings (no holes in center of rubber). 16.040 -0.15 .....  
**\$43.75 EA** ⚠

- 3684802A** ..... **47-53**  
W/out mouldings. 1 piece for V-Bent, V-Butt. 16.040 -0.15 .....  
**\$115.50 EA** ⚠



- 3703533** ..... **54**  
W/out mouldings. 16.040 -0.15 .....  
**\$37.00 EA** ⚠



- 3703534** ..... **54**  
For mouldings. 16.040 -0.15 .....  
**\$37.50 EA** ⚠

**Setting Tape**



- 603954B** ..... **29-46**  
Windshield glass (120 in. length). Includes both 1/32" and 1/16" 10.696 -0 .....  
**\$25.75 SET** ⚠

- 603954BULK^** ..... **ALL**  
1/32 in. thick, sold by the inch 10.696 -0 .....  
**\$0.25 IN** ⚠

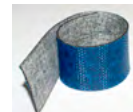

- 603955BULK^** ..... **ALL**  
Setting tape 1/16 in. thick sold by the inch 10.696 -0 .....  
**\$0.25 IN** ⚠

**Screw Set**



**3684481A** .....**.47-54**  
Windshield garnish moulding (14 pcs).  
16.290 -0.4 ..... **\$3.50 SET** ⚠

**Odds & Ends**

Please call for availability on all Odds & Ends parts; once part is sold, it may no longer be in stock.

**3684809U** .....**.47-53**  
Moulding outer windshield w/  
reinforcement 16.017 -0.4  
..... **\$50.00 EA** ⚠



**1948 - Boots**

Returns require a return authorization number—call first. • Product pricing & availability subject to change.

**220 Phone: (360) 816-0211 • (800) 999-CHEV (2438) • www.chevsofthe40s.com**

 **WARNING:** Cancer and Reproductive Harm — [www.P65Warnings.ca.gov](http://www.P65Warnings.ca.gov)

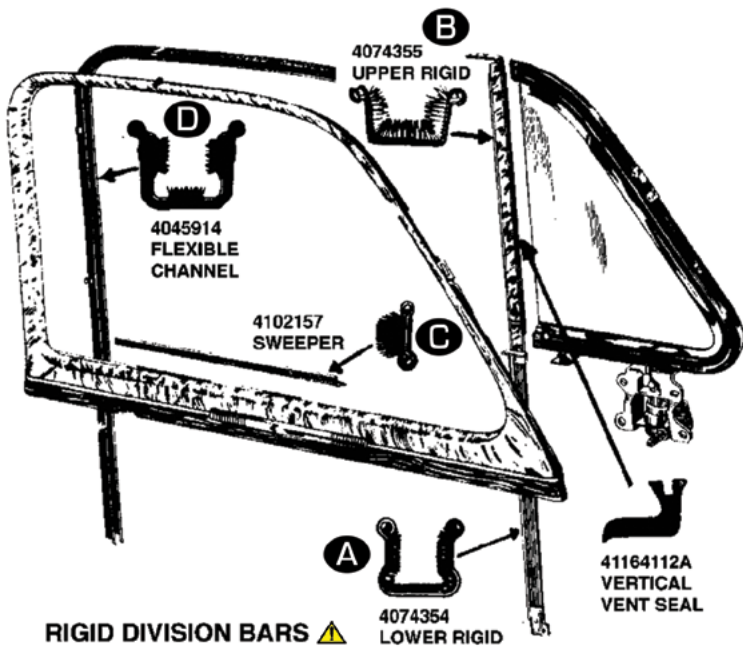

**RIGID DIVISION BARS** ⚠️

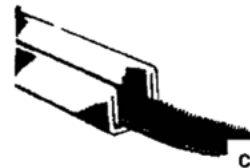

FOR RELINING PERMANENT GUIDE BARS ON A FEW CONVERTIBLES. BLACK MOHAIR LINING MATERIAL WITH RUBBERIZED BACKING TO BE CEMENTED IN PLACE.

CC 22 (1 5/8" WIDE) \$13.75 FT.

**For all Nomads & Wagons**

'46-'56 GLASS SETTING SEAL USED ON TL GATE ONLY. 01C201PL \$3.50 FT.

LOWER SIDE WINDOW CARRIER GLASS SETTING WITH WEATHER LIP FOR 5/8" CHANNEL DEPTH. '30-'40 CHEV. '46-'56 STATION WAGON 01A201PL \$4.75 FT.

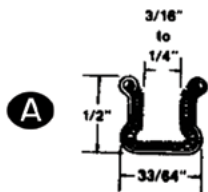

'40-'60 GM RIGID RUN CHANNEL SIDE WINDOW, LOWER  
4074354-36" PC. \$16 EA

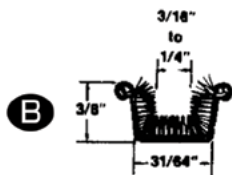

'33-'60 GM CARS RIGID DIVISION BAR WITH STAINLESS STEEL BEAD  
4074355-36" PC. \$12.75 EA  
ACTUAL SIZE

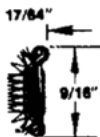

FLEXIBLE SWEEPER G.M.C. TRUCKS '46-'49 LATE 50's GM CARS STAINLESS STEEL BEAD  
3684760 \$0.50 per inch

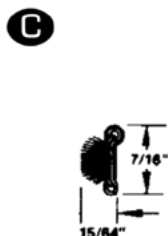

FLEXIBLE SWEEPER '33-'60 CHEV  
INNER & OUTER BELT-LINE. ALSO SLIDING QTR. WINDOWS. EASILY FORMED FOR QTR. WIND.  
STAINLESS STEEL BEAD  
4102157 \$0.25 per inch

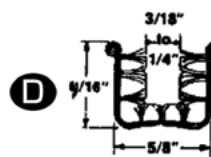

FLEXIBLE GLASS CHANNEL, MOHAIR LINED, CLOTH COVERED, STAINLESS STEEL BEADS. FITS '33-'60 GM SIDE WINDOWS.  
4045914-108" PC. \$36.00 EA

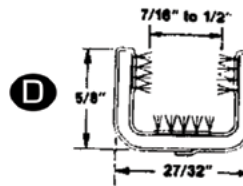

FLEXIBLE GLASS CHANNEL, MOHAIR LINING. '50-'63 CHEV & GMC TRUCKS '41-'64 GM CARS. FOR WINDOWS WITH METAL FRAMES ONLY.  
3684434A-96" PC. \$54.25 EA

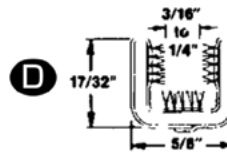

FLEXIBLE, UNBEADED PILE LINED. FITS '33-'62 CHEV & GMC PICKUPS & PANELS WITHOUT FRAMED SIDE GLASS.  
598746-96" PC. \$29.00 EA



**2127 Parkerized**

Door window reveal moulding fastener, corner: Chevrolet '41-'48 Special Deluxe Oldsmobile '41-'48, Model 60 Pontiac '41-'48, Models 25 and 27 \$3.00 EA

TO BE SLIPPED ON DOOR PANEL FASTENER STRIP FOR REPAIRS TO REPLACE BROKEN NAILS IN PANEL EDGING.



7/16" NAIL (.460)  
ALL GENERAL MOTORS  
WF18 \$2.00 (2 pcs)  
"NAIL ON" DOOR PANEL REPAIR CLIPS



**WARNING:** Cancer and Reproductive Harm — www.P65Warnings.ca.gov

Chemicals shipped domestic ground only (Lower 48 states only). No international shipping.

Phone: (360) 816-0211 • (800) 999-CHEV (2438) • www.chevsofthe40s.com

**SECTION 440T  
RESTORATION PARTS**

**Vent Window Assembly**



**3699713B... 51-54**  
Left side assembly with glass and chrome post.  
16.173 -0.15  
..... **\$336.00 EA** ⚠



**3699713BP ..... 51-54**  
Left side assembly with glass and painted post. 16.173 -0.15  
..... **\$278.75 EA** ⚠



**3699714B ..... 51-54**  
Right side assembly with glass and chrome post. 16.173 -0.15  
**\$309.00 EA** ⚠



**3699714BP. .51-54**  
Right side assembly with glass and painted post  
16.173 -0.15  
..... **\$288.50 EA** ⚠



**3695655 .... 51-55**  
Left side outer assembly. Black frame (no glass).  
Note: Does not come with vertical vent seals.  
16.173 -0.15  
..... **\$148.00 EA** ⚠

**3695656 ..... 51-55**  
Right side outer assembly. Black frame (no glass).  
Note: Does not come with vertical vent seals. 16.173 -0.15  
..... **\$148.00 EA** ⚠

**Vent Window Handle**



**3695416R ..... 51-54**  
Right. 16.176 -0.15  
..... **\$16.00 EA** ⚠



**3695417L ..... 51-54**  
Left. 16.176 -0.15  
..... **\$16.00 EA** ⚠

**Vent Window Rubber**



**3696027 .... 51-54**  
Original C shape w/ upper pivot pins, verticals w/ metal backs. 16.175 -0.15

..... **\$49.25 PR** ⚠

**3696027A... 51-54**  
Vertical vent window rubber seal 16.175 -0  
..... **\$49.00 PR** ⚠



**Pivot Pin**



**4173376 ..... 51-65**  
Vent window. Upper  
10.669 -0.4  
..... **\$2.50 PR** ⚠

**Tool**



**4173376A ..... 49-65**  
Sets vent window pivot pin. 10.669 -0.15  
..... **\$5.00 EA** ⚠

**SECTION 450T  
RESTORATION PARTS**

**Window Reveal Mouldings**

**3684847 ..... 47-54**  
Left door, primered. 16.185 -0.15  
..... **\$55.25 EA** ⚠

**Window Reveal Mouldings, cont.**

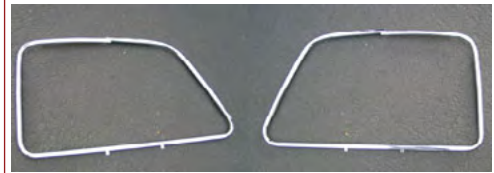

**3684847B ..... 47-54**  
Exterior chrome plated Stainless.  
16.185 -0.15  
..... **\$188.75 L&R** ⚠



**3684848 ..... 47-54**  
Right door, primered. 16.185 -0.15  
..... **\$55.25 EA** ⚠

**Garnish Moulding**



**3684481 ..... 47-50**  
Interior left side. Primered. 16.290 -0.15  
..... **\$85.25 EA** ⚠

**3684482 ..... 47-50**  
Interior right side. Primered. 16.290 -0.15  
..... **\$85.25 EA** ⚠

**Window Shades**



**987203A ..... 51-54**  
Accessory. Stainless steel mounts over door glass. 9.694 -0.15  
..... **\$46.25 PR** ⚠

**Glass Channel Kit**

Window Channel Kits: These are super complete and include sweepers, rigid channel, flexible channel, stops, screws, clips & rubber bumpers as needed. Complete for 2 doors.  
Note: Window Channel Kits are oversized. Special shipping rates apply, please call for rate.  
**598746B ..... 37-46**  
Glass channel kit includes flexible cloth covered channel, inner and outer rubber window wiper, window stop bumpers, clips and screws to install. 16.200 -0.15  
..... **\$95.00 KIT** ⚠





**Glass Channel Kit, cont.**

**3684434** ..... **47-50**  
Glass Channel Kit. 16.200 -0.15

..... **\$130.00 KIT** ⚠

**3699865B** ..... **51-54**  
For original doors with vent windows. 16.200 -0.15

..... **\$110.00 KIT** ⚠

**3699865C** ..... **51-54**  
For doors that have been modified with removed vent windows. 16.200 -0.15

..... **\$135.00 KIT** ⚠

**Quarter Channel Kit Suburban**

**4070069C** ..... **47-54**  
Fits Suburban. Complete for two windows. W/ quarter window rubber (#4070069).

17.136 -0

..... **\$110.00 SET** ⚠

**Lower Glass Sash Channel**



**598690** ..... **36-40**  
Lower door glass setting channel as original 16.190 -0.2

..... **\$81.25 L&R** ⚠



**3657491** ..... **41-46**  
Lower door glass setting channel as original 16.190 -0.2

..... **\$81.00 L&R** ⚠



**3684169B** ..... **47-50**  
Lower door glass setting channel as original. Doesn't include track for window regulator. 16.190 -0.2

..... **\$76.75 L&R** ⚠



**3695551** ..... **51-55**  
51-55 (1st Series) 16.190 -0.15

..... **\$46.00 EA** ⚠

**Regulator Upper Guide**



**4099974** ..... **47-50**  
Cam Track 16.261 -0.2

..... **\$36.75 EA** ⚠

**Setting Tape Door Glass**



**60395440** ..... **37-40**

Setting tape for 2 doors (120 in. length).

10.696 -0

**60395450** ..... **\$16.25 SET** ⚠

Setting tape for 2 doors (168 in. length).

10.696 -0.15

..... **\$16.50 SET** ⚠

**60395454** ..... **51-54**

Setting tape for 2 doors (90 in. length).

10.696 -0.15

..... **\$10.75 SET** ⚠

**603954BULK^** ..... **ALL**

1/32 in. thick, sold by the inch 10.696 -0

..... **\$0.25 IN** ⚠

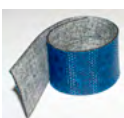

**603955BULK^** ..... **ALL**

Setting tape 1/16 in. thick sold by the inch

10.696 -0

..... **\$0.25 IN** ⚠

**Window Wiper**



**3847051** ..... **36-46**

Inner & outer rubber included in channel kit (4 piece) 16.183 -0.15

..... **\$16.50 SET** ⚠



**3847608** ..... **47-50**

Outer (rubber included in channel kit).

16.183 -0.15

..... **\$36.25 PR** ⚠



**3847608A** ..... **51-54**

Outer (rubber included in channel kit).

16.183 -0.15

..... **\$8.00 SET** ⚠

**Channel (Guide)**



**3809865B** ..... **47-50**

W/ brackets, lower rear door glass.

16.190 -0

..... **CALL** ⚠



**3721781A** ..... **51-54**

W/ brackets, lower rear door glass.

16.190 -0.15

..... **\$38.00 PR** ⚠

**Lower Glass Run Post**



**3685369** ..... **47-50**

W/ brackets, left lower front door glass.

16.190 -0.15

..... **\$40.00 KIT** ⚠

**3685370** ..... **47-50**

W/ brackets, right lower front door glass.

16.190 -0.2

..... **\$40.00 KIT** ⚠



**3685369M** ..... **47-54**

W/ brackets, lower front door glass. For vent window removal. 16.190 -0.2

..... **\$40.00 KIT** ⚠

**3685370M** ..... **47-54**

W/ brackets, lower front door glass. For vent window removal. 16.190 -0.2

..... **\$40.00 KIT** ⚠

**Window Stop Bumper**



**3681072** ..... **36-46**

Window Stop Bumper.

16.245 -0.3

..... **\$2.25 PR** ⚠



**4131052** ..... **47-54**

Window Stop Bumper

10.716 -0.15

..... **\$4.00 PR** ⚠

**Screws & Sleeve Nuts**



**3694071** ..... **47-50**

Attaches upper and lower door frame glass.

16.190 -0.15

..... **\$5.00 SET** ⚠

**Adhesives & Sealers**



**306105** ..... **ALL**

Super Glue Gel.

Bonds to ABS, Ceramic, cork, G10 Epoxy Glass, Leather and paper. Splice window gaskets & sponge weather strip & more. 8.800 -0.15

..... **\$3.50 EA** ⚠



**WARNING:** Cancer and Reproductive Harm — [www.P65Warnings.ca.gov](http://www.P65Warnings.ca.gov)

Chemicals shipped domestic ground only (Lower 48 states only). No international shipping.

**Phone: (360) 816-0211 • (800) 999-CHEV (2438) • [www.chevsofthe40s.com](http://www.chevsofthe40s.com)**

**Adhesives & Sealers, cont.**



**306106 . . . . .ALL**  
 LOCTITE Super Glue,  
 Ultra Gel Control.  
 Bonds to Metal,  
 Rubber, Ceramics,  
 Wood, Leather,  
 Paper & Plastics.  
 Rubber to metal &  
 rubber to rubber  
 bonding. Splice

window gaskets & sponge weather strip &  
 more. 8.800 -0.15

**\$5.25 EA** ⚠️



**511114 . . . . .ALL**  
 3M, Black weatherstrip cement, 5-oz tube.  
 Superior product!. 8.800 -0.2

**\$20.00 EA** ⚠️



**986199A . . . . .ALL**  
 3M Contact  
 cement for rubber  
 to metal. Bonds  
 instantly. Industrial  
 quality for gravel  
 guards, running  
 board rubber, etc.

8.800 -0.15  
**\$64.75 QT** ⚠️



**GL14 . . . . .ALL**  
 Windshield sealer.  
 Seals leaks in new &  
 old installation. Will  
 not dry out rubber.  
 Remains pliable.  
 8.991 -0.15

**\$7.25 EA** ⚠️

**Odds & Ends**

Please call for availability on all Odds & Ends  
 parts; once part is sold, it may no longer be in  
 stock.

**3684847 . . . . .47-53**  
 Reveal door mouldings, left (Used)

16.181 -0.4

**\$75.00 EA** ⚠️

**SECTION 460T  
 STREET ROD PARTS**

**Power Window Conversion Gear  
 Driven Bolt In**

These kits directly bolt into original mounting  
 holes. 1018 cold rolled steel, brass oilite  
 thrust bearings, Delco OEM Motors and  
 gear teeth cryogenically treated for long life.  
 Includes Delco OEM Chrome or Illuminated  
 switches and conduit for wiring. Comes with a  
 lifetime warranty.



**3684175 . . . . .36-46**

1936-46 Chevy truck. Complete kit with  
 chrome or black switches. 16.180 -0

**\$524.00 PR** ⚠️

**3684176 . . . . .47-50**

1947-50 Chevy truck. Complete kit with  
 chrome or black switches. Fits Suburban  
 & COE also 16.180 -0

**\$473.25 PR** ⚠️

**3684177 . . . . .51-54**

1951-54 Chevy Truck, Panel Truck,  
 Suburban and COE. Complete kit with  
 chrome or black switches. 16.180 -0

**\$473.25 PR** ⚠️

**36841771 . . . . .51-54**

1951-54 Chevy truck. Complete kit with  
 chrome or black switches. Includes kit for  
 vent window removal conversion. 16.180 -0

**\$579.00 PR** ⚠️

**Power Window Conversion Cable  
 Driven**

These kits come complete with two cable drive  
 regulators. Uses heavy duty OEM style motors  
 (switches & harness sold separately)



**3684164 . . . . .51-54**

Trucks WITH vent window. Bolt in.  
 Does NOT include switches or wiring  
 harness (sold separately). 16.180 -0.15

**\$418.00 PR** ⚠️

**Window Crank Switch**

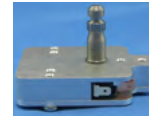

**NU-CRANKS12 . . . . .ALL**  
 Use your original  
 crank handles as your  
 switches. GM 1949  
 & earlier, small round

spline. Pair. -0.15

**\$240.00 PR** ⚠️

**NU-CRANKS13 . . . . .ALL**

Use your original crank handles as your  
 switches. GM 1950 & later, large round  
 spline, long shaft. Pair. -0.15

**\$239.50 PR** ⚠️

**NU-CRANKS14 . . . . .ALL**

Use your original crank handles as your  
 switches. GM 1950 & later. Large round  
 spline, short shaft. Pair. -0.15

**\$240.00 PR** ⚠️

**NU-CRANKSU . . . . .ALL**

Use your original crank handles as your  
 switches. Upgrade to power window kit  
 only -0.15

**\$180.50 PR** ⚠️

**SECTION 460T  
 RESTORATION PARTS**

**Window Regulator**



**594279A . . . . .36-46**  
 Repair kit. Left or right  
 side. Includes rivets  
 & spring inside cup.

16.260 -0.15

**CALL** ⚠️



**594279AS . . . . .36-46**

Spring -Window  
 Regulator Clutch

16.260 -0

**\$3.25 EA** ⚠️



**594279GA . . . . .36-46**

Window Regulator Large  
 Metal Gear 38 Teeth

16.260 -0.15

**\$22.00 EA** ⚠️



**3676433 . . . . .47-50**

Complete with arms. Left. 16.260 -0.15

**\$61.25 EA** ⚠️



**3676433A . . . . .47-50**

Repair kit. Left or right  
 side. Includes rivets &  
 spring inside cup. -0

**CALL** ⚠️



# Section 460T: Window Crank, Window Regulator & Power Window Kits

## Window Regulator, cont.



**3676434** ..... **47-50**  
Complete with arms. Right. 16.260 -0.15

..... **\$61.25 EA** ⚠



**3695521A** ..... **47-54**  
Spring. 16.260 -0.15

..... **\$4.75 EA** ⚠



**3695521** ..... **51-54**  
Complete with arms. Left. 16.260 -0.15

..... **\$67.50 EA** ⚠

**3695522** ..... **51-54**  
Complete with arms. Right. 16.260 -0.15

..... **\$67.50 EA** ⚠

## Knob



**598910A** ..... **39**  
Window or windshield crank. Black. 16.270 -0.15

..... **\$14.75 EA** ⚠



**3654632B** ..... **40-46**  
Window or windshield crank. Rose tan. 16.270 -0.15

..... **\$14.00 EA** ⚠



**3683723A** ..... **47-50**  
Window crank, chrome. Original color and quality. 16.270 -0

..... **CALL** ⚠



**3702164A** ..... **54-57**  
Window crank, black. 16.270 -0.4

..... **\$15.00 EA** ⚠

## Window Crank



**4200151** ..... **29-38**  
With chrome knob 16.270 -0.15

..... **\$42.50 EA** ⚠

## Window Crank, cont.



**3654595** ..... **36-46**  
Window crank and interior door handle retaining screw 16.270 -0.15

..... **\$4.75 EA** ⚠



**598910** ..... **39**  
With black knob. 16.270 -0.15

..... **\$34.75 EA** ⚠



**3654632A** ..... **40-46**  
With rose tan knob. 16.270 -0.15

..... **\$39.75 EA** ⚠



**3683723** ..... **47-50**  
W/ chrome knob for you to install. 16.270 -0

..... **CALL** ⚠



**3702164B** ..... **47-60**  
W/ replacement black knob. 16.270 -0.15

..... **\$14.00 EA** ⚠



**3702164** ..... **54-57**  
W/ black knob. 16.270 -0.2

..... **\$16.50 EA** ⚠

## Odds & Ends

Please call for availability on all Odds & Ends parts; once part is sold, it may no longer be in stock.

**3654632U** ..... **39-46**  
Window crank w/ ivory knob (Used) 16.270 -0.4

..... **\$15.00 EA** ⚠

**3702164BU** ..... **47-60**  
Window crank (Used) 16.200 -0

..... **\$6.00 EA** ⚠

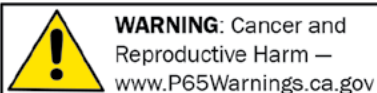

**WARNING:** Cancer and Reproductive Harm — [www.P65Warnings.ca.gov](http://www.P65Warnings.ca.gov)

Chemicals shipped domestic ground only (Lower 48 states only). No international shipping.

Phone: (360) 816-0211 • (800) 999-CHEV (2438) • [www.chevsofthe40s.com](http://www.chevsofthe40s.com)

**SECTION 480T  
STREET ROD PARTS**

**Back Glass & Frame**

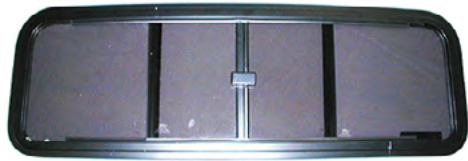

**3704319C** .....47-54  
Slider, with snap closer. Smoke tinted glass. Black frame. 16.464 -0.15 .....  
**\$169.25 EA** ⚠

**SECTION 480T  
RESTORATION PARTS**

**Back Glass Rubber**

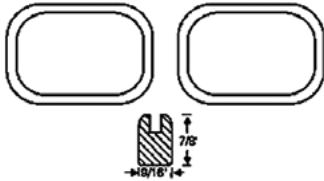

**463535** .....34-38  
Panel & Suburban, vulcanized 16.470 -0.15 .....  
**\$113.00 PR** ⚠

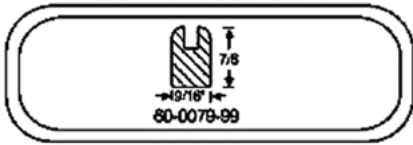

**3847421** .....36-38  
Low roof cab, vulcanized 16.470 -0.15 .....  
**\$117.25 EA** ⚠

**599701** .....36-42  
For die cast frame 16.470 -0.15 .....  
**\$30.75 EA** ⚠



**3847420** .....39-42  
Vulcanized, for die cast frame 16.470 -0.15 .....  
**\$117.25 EA** ⚠

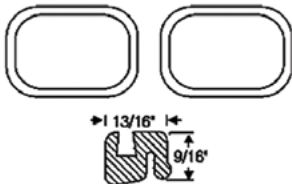

**3806252** .....39-46  
Panel & Suburban, vulcanized 16.470 -0.15 .....  
**\$120.75 PR** ⚠

**3847418** .....42-46  
W/ chrome lock strip 16.470 -0.2 .....  
**\$18.00 SET** ⚠

**Back Glass Rubber, cont.**

**3847419** .....42-46  
With lock strip 16.470 -0.2 .....  
**\$18.00 SET** ⚠

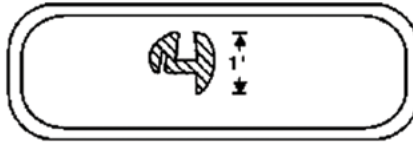

**3807917** .....47-54  
Panel & Suburban w/ end gate, vulcanized 16.470 -0.15 .....  
**\$107.75 EA** ⚠



**3847416** .....47-54  
W/ chrome lock strip 16.470 -0.15 .....  
**\$18.00 SET** ⚠

**3847417** .....47-54  
W/ lock strip 16.470 -0.15 .....  
**\$18.00 SET** ⚠

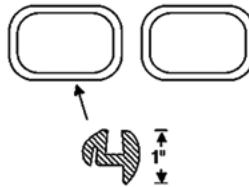

**3807535** .....47-57  
Panel & Suburban w/ doors, vulcanized 16.470 -0.15 .....  
**\$119.25 PR** ⚠



**3807535A** .....47-57  
Panel & Suburban w/ doors. 16.470 -0.15 .....  
**\$34.25 PR** ⚠

**Screw Set**



**3667020B** .....37-41  
Back glass frame (clutch head). 16.475 -0.15 .....  
**\$6.75 SET** ⚠

**Rear Corner Glass Rubber**



**3847414** .....47-54  
W/ chrome lock strip 16.470 -0.15 .....  
**\$18.00 PR** ⚠

**Rear Corner Glass Rubber, cont.**



**3847415** .....47-54  
W/ lock strip 16.470 -0.15 .....  
**\$18.00 PR** ⚠

**Chrome Lock Strip**



**3847415A** .....42-54  
Back glass (8 ft) 16.469 -0.15 .....  
**\$6.00 EA** ⚠



**3847415B** .....47-54  
Corner glass (8ft) 16.469 -0.15 .....  
**\$6.00 PR** ⚠

**Rectangular Retaining Rubber**



**4070069** .....47-54  
For quarter window, Suburban (does two windows) 17.136 -0.15 .....  
**\$52.00 PR** ⚠

**Black Lock Strip Bulk**



**01B7951AS** .....ALL  
For Back Glass Rubber. Fits rear and quarter glass. Sold by the foot. 16.469 -0.4 .....  
**\$1.50 FT** ⚠

**Chrome Lock Strip Bulk**



**01B7951AC** .....ALL  
For rear and quarter glass. Sold by the foot. 16.469 -0.3 .....  
**\$1.50 FT** ⚠

**Tool**



**3847415T** .....42-54  
Inserts back glass rubber lock strip. 16.469 -0.15 .....  
**\$54.00 EA** ⚠



# ADD COLOR AND STYLE TO YOUR TRUCK BED WITH EXOTIC AND DOMESTIC BED WOODS!!

Kiln-dried and stabilized. Properly milled, sanded and ready to finish.



Sets are **milled to order** using only kiln dried "better than cabinet grade" lumber to assure you receive only the **highest quality product**. All pieces are 3/4" thick, grooved and trimmed to length. **Sanded** using a multi-step process providing a uniform and **extremely smooth surface**, ready to finish right out of the box. (Does not come stained or with final finish.) Boards individually numbered for ease of installation and chosen and matched based on color, character and grain. **Grooves available** to fit both OEM and Custom-style bed strips at **no extra charge**. Professional packaging to minimize potential damage during shipping. **Custom width and lengths** are available to meet your specific requirements. **Many other types of woods available**. Call for pricing.

part #	Short Beds		
BWP101	1937-39	6 boards	75-7/8"
BWP102	1940-45	6 boards	76-7/8"
BWP103	1946	7 boards	76-7/8"
BWP104	1947-51	9 boards	76-7/8"
BWP105	1951-54	8 boards	77-1/8"
Long Beds			
BWP109	1937-45	6 boards	85-7/8"
BWP111	1946	7 boards	85-7/8"
BWP112	1947-51	9 boards	85-13/16"
BWP113	1951-53	8 boards	85-13/16"
BWP114	1954	8 boards	89"
1 Ton			
BWP118	1947-51	8 boards	107"
BWP119	1952-54	8 boards	107"



**WARNING:** Cancer and Reproductive Harm — [www.P65Warnings.ca.gov](http://www.P65Warnings.ca.gov)

Chemicals shipped domestic ground only (Lower 48 states only). No international shipping.

**Phone: (360) 816-0211 • (800) 999-CHEV (2438) • [www.chevsofthe40s.com](http://www.chevsofthe40s.com)**

**SECTION 490T  
STREET ROD PARTS**

**Bed Lids**

Standard Features and Benefits

- Resin filled composite honeycomb give a durable, long lasting construction.
- Built in stainless steel cross bar hinge is laminated into the truck lid giving our hinge system strength and durability.
- 2 double stage locking system for extra security.
- Dual heavy duty gas struts are mounted to assist in opening & closing the lid.
- Double weather seal helps protect cargo from the elements.
- Neoprene inside trim seal helps protect bed rail from excessive wear and tear.
- Nylon pull strap to assist in closing.

Their classic lids are made out of composite fiberglass to last the test of time just like your classic truck.

- Reduces wind drag and saves fuel.
- Easy to install or remove.
- Proven, tight fit.
- Black, white or primered finish.

\*OPTION: Under the lid charcoal carpeting tops the interior of our Traditional Lids giving it a plush look and feel.



**BEDLID-TPC . . . . .47-53**  
Primered finish. With carpet under lid.  
17.499 -0.15 . . . . . **\$2,150.00 EA** ⚠



**BEDLID-BPC . . . . .54**  
Primered finish. With carpet under lid.  
17.499 -0.15 . . . . . **\$1,450.00 EA** ⚠

**Bed Lids, cont.**



**BEDLID-TP . . . . .54**  
Primered finish. 17.499 -0.15 . . . . .  
**\$1,300.00 EA** ⚠

**Pros Pick Custom Bed Chevy**

FABRICATED FROM 16 GAUGE, SATIN COATED STEEL (SIMILAR TO GALVANIZED)

- Plug welded construction (no unsightly spot welds).
- Epoxy primed so you can block sand and paint.
- Includes 2 sides, closed stake pockets, front panel and all cross members.

\*TAILGATE, BED STRIPS AND WOOD NOT INCLUDED.



TAILGATE SOLD SEPARATELY

**25230100 . . . . .30-36**  
Standard bed size and height. 20.000 -0.15  
. . . . . **\$1,575.00 SET** ⚠

**25237100 . . . . .37-39**  
Standard bed size and height. 20.000 -0.15  
. . . . . **\$1,575.00 SET** ⚠

**25240100 . . . . .40-46**  
Standard bed size and height. 20.000 -0.15  
. . . . . **\$1,576.75 EA** ⚠

**25247100 . . . . .47-53**  
Standard bed size and height. 20.000 -0.15  
. . . . . **\$1,576.75 EA** ⚠

**25247T100 . . . . .47-53**  
3 inch taller height than standard.  
20.000 -0.15  
. . . . . **\$1,720.00 EA** ⚠

**25254100 . . . . .54-55**  
Standard bed size and height. Fits 1st Series. 20.000 -0.15  
. . . . . **\$1,720.00 SET** ⚠

**Custom Tailgate**

Stock tailgates have exposed hinges that leak rusty water, chains that damage expensive paint and unsightly, poorly designed latches. These custom tailgates are manufactured from 16 gauge, satin coated steel. Hidden hinges concealed into the rear cross member. Hidden latch assemblies actuated by 2 small knobs on the inside of the tailgate. Nylon latch bolts and stainless steel strikers assure smooth, quiet and rust free operation. Mounts to Pro's Pick Custom Beds as well as Stock Beds to add a clean custom look to your original bed.



**TAILGATEPRO . . . . .46-87**  
Smooth, clean finish. Add-on option to complete Pros' Pick bed (also sold separately). Smooth, clean finish. -0.15  
. . . . . **\$851.00 EA** ⚠



**TAILGATEPROW . . . . .46-87**  
Smooth, clean finish. Fits pro's pick and other stock beds. -0.15 . . . **\$1,015.75 EA** ⚠

**Power Tailgate**



**POWERGATE . . . . .ALL**  
Electric power unit operates your tailgate either thru your remote or switch (included). 17.615 -0.15 . . . **\$500.00 KIT** ⚠



**Pros Pick Custom Roll Pan Chevy**



**01101500TL...47-53**  
LED Tail Light for pro's pick roll pan. Upgrade only. . 12V -0.15  
..... **\$359.00 PR** ⚠️



**23247100.....47-53**  
Bolt-on, smooth. 1-piece, 12ga. steel. Recess for license plate. Use with Pro's

Pick tailgate only (order 4-piece roll pan for stock tailgates). -0.15

..... **\$450.00 EA** ⚠️

**Steel Corrugated Bed Floor**

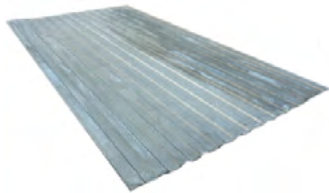

**3847403S.....ALL**

Do you use your truck for work and don't want to ruin a nice wood floor? This steel corrugated bed floor was designed for you. 80" long for short stepside beds. -0  
**\$750.00 EA** ⚠️



**3847404S.....ALL**

Do you use your truck for work and don't want to ruin a nice wood floor? This steel corrugated bed floor was designed for you. 96" long for long stepside beds. -0  
**\$950.00 EA** ⚠️

**Fuel Filler Concealment Kit**



**LHRSCK.....ALL**

Hide your fill neck in the bed. Motor lifts a bed wood panel for easy access. All stainless & aluminum hardware, hinges, motor & switch included. 17.438 -0  
.....  
**\$749.25 SET** ⚠️

**Tailgate Hidden Latch**

Stock tailgates are beautiful, they hold the classic look that is near and dear to all enthusiasts. They also carry those tailgate chains that ruin our \$10,000 paint jobs. When Pros Pick designed this kit they felt the criteria had to be:  
-Anyone could handle the installation.  
-The tailgate had to slam shut.  
-No rattles allowed as you drive down the road.  
-None of the materials used could ever rust.  
-It had to have check straps that could not damage the paint.  
-You could install it on a painted bed without damaging the paint job.  
-It had to look cool, yet be compatible with the vintage look of the truck.  
-A touch of the release buttons on each side allow the gate to open.



**26300016.....ALL**

Latch kit with 16 inch straps. -0.15  
.....  
**\$185.25 SET** ⚠️

**26300021.....ALL**

Latch kit with 21 inch straps. -0.15  
.....  
**\$185.25 SET** ⚠️

**Tailgate Link Assembly**



**MAK102835.....41-53**

Remove tailgate chains (modification to bed sides required). Includes instructions. 1941-53 -0.15  
..... **\$84.25 PR** ⚠️

**MAK102835S.....41-53**

Remove tailgate chains (modification to bed sides required). Includes instructions. Polished Stainless. 1941-53 -0.15  
.....  
**\$160.25 PR** ⚠️

**Tailgate Link Assembly, cont.**



**MAK102834.....54-87**

Remove tailgate chains (modification to bed sides required). Includes instructions. 1954-87 Stepside only. -0.15  
.....  
**\$84.25 PR** ⚠️

**MAK102834S.....54-87**

Remove tailgate chains (modification to bed sides required). Includes instructions. Polished Stainless. 1954-87 Stepside only. -0.15  
.....  
**\$160.25 PR** ⚠️

**LED Bed Roll Light**

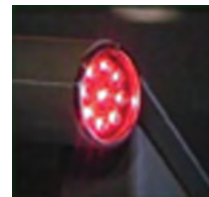

**LEDBEDLITE.....ALL**

LED tail light w/ Aluminum housing in 15/16" (red only), 1-1/8", 1-1/4" or 1-5/8" diameters. Choose Amber or Red. 12V 0.000 -0 .. starting at **\$110.00 PR** ⚠️



**MAK102864.....ALL**

Red LEDs. Billet aluminum w/ polished bezel. Dual intensity for tail light and brake/ turn signal. Includes 10" pigtail. Fits 40-66 Chevy, 40-87 GMC. 12V. 1-19/32 hole. 0.000 -0  
.....  
**\$148.00 PR** ⚠️



**MAK102865.....ALL**

19 Amber LEDs. 12V. 1-19/32 hole. 0.000 -0  
.....  
**\$148.00 PR** ⚠️



**WARNING:** Cancer and Reproductive Harm — www.P65Warnings.ca.gov

Chemicals shipped domestic ground only (Lower 48 states only). No international shipping.

**Phone: (360) 816-0211 • (800) 999-CHEV (2438) • www.chevsofthe40s.com**

**LED Bed Roll Light, cont.**



**MAK102866** .....**ALL**  
19 White LEDs for back up lights. 12V.  
1-19/32 hole. 0.000 -0 **\$160.00 PR** ⚠

**Truck Bed Tail Light**



**MAK102853** .....**41-66**  
Chevy - Red. Incandescent bulb (amber  
also available). 0.000 -0 **\$86.00 PR** ⚠

**Bed Roll Reflector**

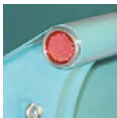

**MAK102850**....**41-66**  
red insert reflector.  
0.000 -0.15  
..... **\$60.25 PR** ⚠

**Billet Caps**



**466423B**.....**37-39**  
1-1/4in. polished  
aluminum w/ bowtie,  
covers hole in bed roll  
17.505 -0

..... **\$56.00 PR** ⚠



**3806518B** ....**41-55**  
1-19/32in. polished  
aluminum w/ bowtie,  
covers hole in bed roll  
17.505 -0

..... **\$56.00 PR** ⚠



**3806518C** .....**41-55**  
1-19/32 in. brushed  
aluminum, covers hole  
in bed roll. 17.505 -0

..... **\$43.00 PR** ⚠

**Gas Cap**



**KUSC-312521** .....**ALL**  
Polished Billet Aluminum. 2-1/2" dia. Twist  
to pop open. -0.15 ..... **\$164.75 EA** ⚠

**SECTION 490T  
RESTORATION PARTS**

**Bed Radius Corners**



**4754BC**.....**47-54**

The 1947-1954 Radius  
Bed Corners are made  
from a heavy wall  
tube and give an ultra  
clean look to the bed corners on your  
Advance Design truck bed. These pieces  
can be used on both the front or back  
corners of the box and come with detailed  
instructions for an easy install.

\*Installation will require cutting of the  
original box corners and welding in of the  
Radius Box Corners.

Sold as a pair (2 pieces) -0  
..... **\$130.00 PR** ⚠

**Bed Metal Kit**

The metal parts in this kit are manufactured  
of 16 or 14 gage steel, according to the  
original parts. Parts are ready to primer and  
bolt together. The kit includes hardware to  
bolt these parts together and bolt holes are  
provided. The kit also comes with instructions  
for bed assembly and bed wood installation.  
This kit does not include the wood bed floor  
parts, which may be ordered separately or as a  
wood bed kit.

Kit includes the following:

- Rear Cross Sill Hardware - Zinc Plated Steel
- Front Bed Panels - Original
- Tailgates
- Tailgate Chains - Zinc-Plated Steel - Import
- Tailgate Chain Covers - Black
- Tailgate Hinges - Steel
- Rear Cross Sills - Original
- Cross Sills - Front
- Bed Sides - Driver Side Original
- Bed Sides - Passenger Side Original
- Cross Sills - Second cross sill from the front  
bed panel.
- Bed Mounting Blocks and Pads - Blocks and  
Pads

Note: Midway through the 51 model year, GM  
changed the number of bed strips from eight  
(8) to seven (7) strips. This change affects the  
bed wood, cross sills, rear cross sill and bolt  
kit. If you are ordering for a 51 GM pickup,  
please be sure to select 47-51 for trucks with  
eight (8) bed strips or 51-53 for trucks with  
seven (7) bed strips so your cross sills and  
rear sill will be correct.

34-38 and 41-46 Chevy kits include smooth  
tailgate. 39-40 and 47-53 Chevy kits include  
"CHEVROLET" script tailgate. 47-53 GMC kits  
include "GMC  
script tailgate.

**3690612** .....**37-54**  
Short bed 1/2 Chevy and GMC -0  
.....starting at **\$1,316.99 EA** ⚠

**3690613** .....**41-53**  
Long Bed, 3/4 ton Chevy, 1/2 ton GMC,  
3/4 ton GMC -0  
.....starting at **\$1,884.75 EA** ⚠





# Section 490T: Complete Bed & Bed Parts

## Bed Wood Kit

- 3690615** ..... **37-53**  
Long bed, pine wood with steel strips -0  
..... starting at **\$421.99 EA** ⚠
- 3690617** ..... **37-53**  
Long bed, oak wood with polished stainless strips. -0  
..... starting at **\$670.99 EA** ⚠
- 3690619** ..... **37-53**  
Long bed, oak wood with polished stainless strips and hidden fasteners -0  
..... starting at **\$786.99 EA** ⚠
- 3690614** ..... **37-54**  
Short bed, pine wood with steel strips -0  
..... starting at **\$396.99 EA** ⚠
- 3690616** ..... **37-54**  
Short bed, oak wood with polished stainless strips. -0  
..... starting at **\$610.99 EA** ⚠
- 3690618** ..... **37-54**  
Short bed, oak wood with polished stainless strips and hidden fasteners -0  
..... starting at **\$715.99 EA** ⚠

## Front Bed Panel

Note: Oversize shipping charges apply on all Front Bed Panels. Please call for rates.



- 463673** ..... **34-39**  
W/out hardware, 34-39 Chevy & 34-38 GMC 20.455 -0.15 ..... **\$135.25 EA** ⚠
- 3800261T45** ..... **40-45**  
W/ hardware, 48-1/2 in. wide (for 5 bed strips). 1/2Ton. 20.455 -0.15  
..... **\$135.25 EA** ⚠
- 3800261T46** ..... **46**  
W/ hardware, 48-1/2 in. wide (for 6 bed strips). 1/2Ton. 20.455 -0.15  
..... **\$135.25 EA** ⚠
- 3810042T50** ..... **47-50**  
W/ hardware (1Ton) length 50 in. 20.455 -0.15  
..... **\$297.25 EA** ⚠
- 3810042** ..... **47-53**  
W/ hardware, 50 in. wide (1/2Ton & 3/4Ton) 20.455 -0.15  
..... **\$135.25 EA** ⚠
- 3810042T53** ..... **51-53**  
W/ hardware (1Ton) length 50 in. 20.455 -0.15  
..... **\$297.00 EA** ⚠

## Front Bed Panel, cont.

- 3810404** ..... **54-59**  
No hardware length 49-3/4 in. 20.455 -0.15  
..... **\$135.25 EA** ⚠

## Bed Side Panel

Note: Bed Side Panels are sent Freight Collect. \$75 Crate charge per pair. (Specify with or without stake pockets holes.)

- 46642338** ..... **37-38**  
1/2Ton w/ stake pocket & bed corner strip, left side. 20.455 -0  
..... **\$393.50 EA** ⚠
- 46642438** ..... **37-38**  
1/2Ton w/ stake pocket & bed corner strip, right side. 20.455 -0  
..... **\$393.50 EA** ⚠

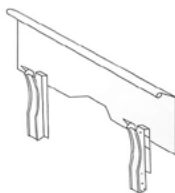

- 46642339** ..... **39**  
1/2Ton w/ stake pocket & bed corner strip, left side. 78-3/8 in. length. 20.455 -0.15 ..... **\$487.50 EA** ⚠
- 46642439** ..... **39**  
1/2Ton w/ stake pocket & bed corner strip, right side. 78-3/8 in. length. 20.455 -0.15  
..... **\$487.50 EA** ⚠
- 46642340** ..... **40**  
1/2Ton w/ stake pocket & bed corner strip, left side. 20.455 -0.15  
..... **\$487.50 EA** ⚠
- 46642440** ..... **40**  
1/2Ton w/ stake pocket & bed corner strip, right 20.455 -0.15  
..... **\$487.50 EA** ⚠
- 46642540** ..... **40**  
3/4Ton w/ stake pocket & bed corner strip, left 20.455 -0  
..... **\$522.00 EA** ⚠
- 46642640** ..... **40**  
3/4Ton w/ stake pocket & bed corner strip, right 20.455 -0  
..... **\$522.00 EA** ⚠
- 380685746** ..... **41-46**  
1/2Ton w/ stake pocket & bed corner strip, left side. 20.455 -0.15  
..... **\$393.50 EA** ⚠
- 380685846** ..... **41-46**  
1/2Ton w/ stake pocket & bed corner strip, right side. 17.505 -0.15  
..... **\$393.50 EA** ⚠

## Bed Side Panel, cont.

- 380651753** ..... **41-53**  
3/4Ton w/ stake pocket & bed corner strips, left side. 20.455 -0.15  
..... **\$565.75 EA** ⚠
- 380651853** ..... **41-53**  
3/4Ton w/ stake pocket & bed corner strips, right side. 20.455 -0.15  
..... **\$565.75 EA** ⚠
- 380685753** ..... **47-53**  
1/2Ton w/ stake pocket & bed corner strip, left side. 79-3/4 in. length. 17.505 -0.15  
..... **\$393.50 EA** ⚠
- 380685853** ..... **47-53**  
1/2Ton w/ stake pocket & bed corner strip, right side. 79-3/4 in. length. 17.505 -0.15  
..... **\$393.50 EA** ⚠
- 381042954** ..... **54**  
1/2Ton w/ stake pocket & bed corner strips, left side. 20.455 -0.15  
..... **\$467.50 EA** ⚠
- 381043054** ..... **54**  
1/2Ton w/ stake pocket & bed corner strips, right side. 17.615 -0.15  
..... **\$467.50 EA** ⚠
- 381251354** ..... **54**  
3/4Ton w/ stake pocket & bed corner strips, left side. 17.505 -0.15  
..... **\$645.00 EA** ⚠
- 381251454** ..... **54**  
3/4Ton w/ stake pocket & bed corner strips, right side. 17.505 -0.15  
..... **\$645.00 EA** ⚠

## Stake Pocket Hole Covers

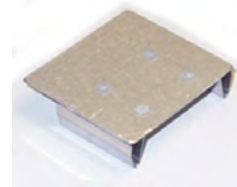

- MAK2001190** ..... **ALL**  
Paintable steel top, stainless base (2 pairs needed per bed). -0.15 ..... **\$32.00 PR** ⚠

## Stake Pockets



- 466423F** ..... **34-39**  
Front 17.462 -0.15  
..... **\$56.25 EA** ⚠

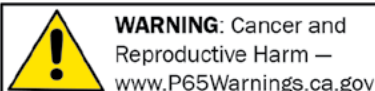



Chemicals shipped domestic ground only (Lower 48 states only). No international shipping.

Phone: (360) 816-0211 • (800) 999-CHEV (2438) • [www.chevsofthe40s.com](http://www.chevsofthe40s.com)

# Section 490T: Complete Bed & Bed Parts

## Stake Pockets, cont.

- 466423L** ..... **34-39**  
Left rear 17.462 -0.15  
..... **\$89.25 EA** ⚠
- 466424R** ..... **34-39**  
Right rear 17.462 -0.15  
..... **\$89.25 EA** ⚠
- 3806857F** ..... **39-53**  
Front (specify left or right) 17.462 -0.15  
..... **\$56.25 EA** ⚠
- 466424L** ..... **40**  
Left rear 17.462 -0  
..... **\$112.25 EA** ⚠
- 466424R** ..... **40**  
Right rear 17.462 -0  
..... **\$112.25 EA** ⚠
- 3806857L** ..... **41-46**  
Left rear 17.462 -0.15  
..... **\$69.25 EA** ⚠
-  **3806858R**... **41-46**  
Right rear 17.462 -0.15  
..... **\$69.25 EA** ⚠
- 3806859L** ..... **47-53**  
Left rear 17.462 -0  
..... **\$69.25 EA** ⚠
-  **3806860R**... **47-53**  
Right rear 17.462 -0  
..... **\$69.25 EA** ⚠
- 3810428FL** ..... **54-59**  
Front Left 17.462 -0.15  
..... **\$74.00 EA** ⚠
- 3810428FR** ..... **54-59**  
Front Right 17.462 -0.15  
..... **\$74.00 EA** ⚠
- 3810429L** ..... **54-59**  
Left rear 17.462 -0.15  
..... **\$81.00 EA** ⚠
- 3810430R** ..... **54-59**  
Right rear 17.462 -0.15  
..... **\$81.00 EA** ⚠

## Bed Strips

Note: Bed Strips over 96 inches are available. Special order, call for price.

Note: Oversize shipping charges apply on Bed Strips. Call for rates. Bed Strips over 96 inches are sent freight collect.

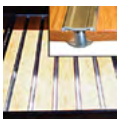

- 384734BS** ..... **37-59**  
Strips, aluminum with hidden fasteners, 3/4Ton. 17.438 -0  
... starting at **\$245.00 SET**

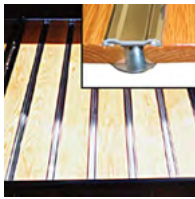

## Bed Strips, cont.

- 384734S** ..... **37-59**  
ALUMINUM strips with hidden fasteners, 1/2Ton. 17.438 -0  
..... starting at **\$175.00 SET** ⚠
- 
- 3847634A** ..... **37-59**  
Short (74 in.-78 in.) aluminum w/ hidden fasteners included (anodized bolt heads hide below strip. Strip end has a blunt finish). Specify year when ordering. For 1/2Ton trucks. 17.438 -0 ..... starting at **\$30.00 EA** ⚠
- 3847634P** ..... **37-59**  
Short (74 in.-78 in.) w/ pre-punched square holes. steel, 1/2Ton, specify year when ordering. 20.438 -0.2  
..... starting at **\$9.00 EA** ⚠
- 3847634X** ..... **37-59**  
Short (74 in.-78 in.) w/ pre-punched square holes. stainless steel, 1/2Ton, specify year when ordering. 17.438 -0  
..... starting at **\$14.00 EA** ⚠
- 3847634Y** ..... **37-59**  
Short (74 in.-78 in.) w/ pre-punched square holes. polished stainless, 1/2Ton, specify year when ordering. 17.438 -0  
..... starting at **\$20.00 EA** ⚠
- 3847635A** ..... **37-59**  
Long (79 in.-96 in.), aluminum, w/ hidden fastener bolts for hidden fastening included, specify year when ordering. For 3/4Ton trucks. 17.438 -0  
..... starting at **\$35.00 EA** ⚠
- 3847635P** ..... **37-59**  
Long (79 in.-96 in.), w/ pre-punched square holes. steel, specify year when ordering. 17.438 -0.15  
..... starting at **\$10.00 EA** ⚠
- 3847635X** ..... **37-59**  
Long (79 in.-96 in.), w/ pre-punched square holes. stainless, specify year when ordering. 17.438 -0  
..... starting at **\$16.50 EA** ⚠
- 3847635Y** ..... **37-59**  
Long (79 in.-96 in.), w/ pre-punched square holes. polished stainless, specify year when ordering. 17.438 -0  
..... starting at **\$24.50 EA** ⚠
- 3847634** ..... **ALL**  
Short (77-1/8 in.), steel, 1/2Ton, no holes. 17.438 -0.15  
..... **\$11.50 EA** ⚠

## Bed Strips, cont.

- 3847634S** ..... **ALL**  
Short (78 in.), stainless, 1/2Ton, no holes. 17.438 -0.15  
..... **\$17.00 EA** ⚠
- 3847634SP** ..... **ALL**  
Short (78 in.), polished stainless, 1/2Ton, no holes. 17.438 -0.15  
..... **\$23.50 EA** ⚠
- 3847635** ..... **ALL**  
Long (96 in.), steel, no holes. 17.438 -0.15  
..... **\$12.50 EA** ⚠
- 3847635S** ..... **ALL**  
Long (79 in.), stainless, no holes. 17.438 -0.15  
..... **\$17.00 EA** ⚠
- 3847635SP** ..... **ALL**  
Long (79 in.-96 in.), polished stainless, no holes. 17.438 -0.15  
..... **\$27.00 EA** ⚠

## Corner Strips

Note: Corner Strips over 96 inches are available. Special order, call for price.

Note: Oversize shipping charges apply on Corner Strips. Call for rates. Corner Strips over 96 inches are sent freight collect.

- 3810803P** ..... **37-59**  
Short bed (74 in.-78 in.) w/ pre-punched square holes. steel, 1/2Ton, specify year when ordering. 17.438 -0.4  
..... starting at **\$30.00 PR** ⚠
- 3810803X** ..... **37-59**  
Short bed (74 in.-78 in.) w/ pre-punched square holes. stainless, 1/2Ton, specify year when ordering. 17.438 -0.15  
..... starting at **\$50.00 PR** ⚠
- 3810803Y** ..... **37-59**  
Short bed (74 in.-78 in.), w/ pre-punched square holes. polished stainless, 1/2Ton, specify year when ordering. 17.438 -0.4  
..... starting at **\$60.00 PR** ⚠
- 3810804P** ..... **37-59**  
Long bed (74 in.-78 in.) w/ pre-punched square holes. steel, specify year when ordering. 17.438 -0.4  
..... starting at **\$36.00 PR** ⚠
- 3810804X** ..... **37-59**  
Long bed (79 in.-96 in.) w/ pre-punched square holes. stainless, specify year when ordering. 17.438 -0.3  
..... starting at **\$56.00 PR** ⚠
- 3847636Y** ..... **37-59**  
Long bed (79 in.-96 in.) w/ pre-punched square holes. polished stainless, specify year when ordering. 17.438 -0.4  
..... starting at **\$74.00 PR** ⚠

Returns require a return authorization number—call first. • Product pricing & availability subject to change.



**WARNING:** Cancer and Reproductive Harm — www.P65Warnings.ca.gov

**Corner Strips, cont.**

- 3810803S** ..... **ALL**  
Short bed (77-1/8 in.). Stainless, 1/2Ton, no holes. 17.438 -0.15  
..... **\$25.00 EA** ⚠
- 3810803SP** ..... **ALL**  
Short bed (77-1/8 in.). Polished stainless, 1/2Ton, no holes. 17.438 -0  
..... **\$31.50 EA** ⚠
- 3847637SP** ..... **ALL**  
Long bed (96 in.), polished stainless steel, no holes. 17.438 -0.15  
..... **\$34.50 EA** ⚠

**Bed Wood**

Note: Oversize shipping charges apply on all Bed Wood. Call for rates.

- 38474030** ..... **37-59**  
OAK. Sized & grooved, 1/2Ton. NO HOLES (specify year when ordering). 20.438 -0  
..... **starting at \$275.00 SET** ⚠

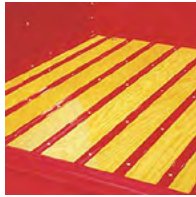

- 3847403P** ..... **37-59**  
PINE. Sized & grooved, 1/2Ton. NO HOLES (specify year when ordering). 17.438 -0.15  
..... **starting at \$280.00 SET** ⚠
- 38474040** ..... **37-59**  
OAK. Sized & grooved, 3/4Ton. NO HOLES (specify year when ordering). 17.438 -0  
..... **starting at \$285.00 SET** ⚠
- 3847404P** ..... **37-59**  
PINE. Sized & grooved, 3/4Ton. NO HOLES. (specify year when ordering). 17.438 -0.15  
..... **starting at \$365.00 SET** ⚠
- 38474030H** ..... **40-59**  
OAK. Sized & grooved, 1/2Ton. With mounting holes (specify year when ordering). 17.438 -0  
..... **starting at \$365.00 SET** ⚠
- 3847403PH** ..... **40-59**  
PINE. Sized & grooved, 1/2Ton. WITH MOUNTING HOLES (specify year when ordering). 17.438 -0  
..... **starting at \$310.00 SET** ⚠
- 38474040H** ..... **40-59**  
OAK. Sized & grooved, 3/4Ton. WITH MOUNTING HOLES (specify year when ordering). 17.438 -0  
..... **starting at \$380.00 SET** ⚠

**Bed Wood, cont.**

- 3847404PH** ..... **40-59**  
PINE. Sized & grooved, 3/4Ton. WITH MOUNTING HOLES (specify year when ordering). 17.438 -0  
..... **starting at \$327.00 SET** ⚠

**Bed Wood GMC**

- 38474050** ..... **37-39**  
OAK. Sized & grooved, GMC long bed. NO HOLES (specify year when ordering). 17.438 -0  
..... **starting at \$370.00 SET** ⚠
- 3847405P** ..... **37-39**  
PINE. Sized & grooved, GMC long bed. NO HOLES (specify year when ordering). 17.438 -0  
..... **starting at \$297.00 SET** ⚠
- 38474050H** ..... **37-55**  
OAK. Sized & grooved, GMC long bed. WITH MOUNTING HOLES (specify year when ordering). 17.438 -0  
..... **starting at \$400.00 SET** ⚠
- 3847405PH** ..... **37-55**  
PINE. Sized & grooved, GMC long bed. WITH MOUNTING HOLES (specify year when ordering). 17.438 -0  
..... **starting at \$327.00 SET** ⚠

**Bed Wood Washer**



- 458394W** ..... **ALL**  
Offset square hole, 1/2T (6 piece) 17.447 -0.15 ..... **\$11.29 SET** ⚠
- 458394WS** ..... **ALL**  
Offset square hole, stainless steel, 1/2T (6 piece) 17.447 -0.15 ..... **\$18.00 SET** ⚠
- 458395W** ..... **ALL**  
Offset square hole, 3/4T (8 piece) 17.447 -0.15 ..... **\$15.00 SET** ⚠
- 458395WS** ..... **ALL**  
Offset square hole, stainless steel, 3/4T (8 piece) 17.447 -0 ..... **\$23.75 SET** ⚠

**Bed Wood & Bed Mount Bolts**

- 458393** ..... **37-59**  
3/4T & long bed, zinc-plated, specify year when ordering. 17.447 -0.4  
..... **starting at \$40.00 SET** ⚠

**Bed Wood & Bed Mount Bolts, cont.**

- 458393S** ..... **37-59**  
3/4T & long bed, stainless steel, specify year when ordering. 17.447 -0.4 ..... **starting at \$82.00 SET** ⚠
- 458393Z** ..... **37-59**  
3/4T & long bed, polished, specify year when ordering. 17.447 -0.4 ..... **starting at \$100.00 SET** ⚠
- 458394** ..... **37-59**  
1/2T, zinc-plated, specify year when ordering. 17.447 -0.4 ..... **starting at \$33.75 SET** ⚠
- 458394S** ..... **37-59**  
Stainless steel, 1/2T. Specify year when ordering. 17.447 -0 ..... **starting at \$72.00 SET** ⚠
- 458394Z** ..... **37-59**  
1/2T, polished 17.447 -0 ..... **starting at \$92.00 SET** ⚠

**Bed Mounting Blocks**

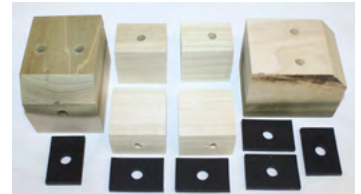

- 458394G** ..... **36-46**  
& pads, cypress, 1/2T 17.447 -0.15 ..... **\$23.00 SET** ⚠
- 458394J** ..... **37-46**  
& pads, cypress, 3/4T 17.447 -0.15 ..... **\$29.75 SET** ⚠
- 458394D** ..... **47-53**  
& pads, cypress, 1/2T 17.447 -0.15 ..... **\$15.00 SET** ⚠

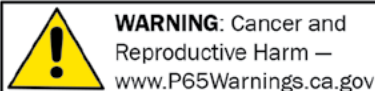

Chemicals shipped domestic ground only (Lower 48 states only). No international shipping.

**Phone: (360) 816-0211 • (800) 999-CHEV (2438) • www.chevsofthe40s.com**

# Section 490T: Complete Bed & Bed Parts

## Bed Mounting Blocks, cont.

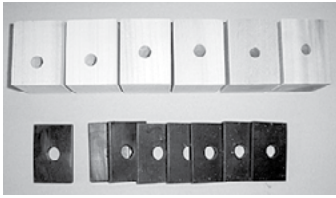

**458394E** .....47-53  
 & pads, cypress, 3/4T 17.447 -0.15 .....  
**\$22.50 SET** ⚠

## Bed Mounting Rubber Pads

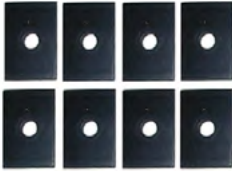

**458394F** .....54-59  
 1/2T 17.447 -0.15 ..... **\$7.00 SET** ⚠  
**458394H** ..... 54-59  
 Long bed & 3/4T 17.447 -0.15  
 ..... **\$12.00 SET** ⚠

## Small Crossmember



**3860566** .....37-57  
 Front or center comes with flange brackets  
 (specify year when ordering). 17.405 -0  
 starting at **\$20.00 EA** ⚠

## Rear Crossmember

**3806578** .....47-51  
 3/4T, no holes, use only on 8 strip 9  
 board beds only 17.405 -0.15  
 ..... **\$168.00 EA** ⚠  
**3806581** .....47-53  
 1T, no holes 17.405 -0.15  
 ..... **\$168.25 EA** ⚠  
**3806578** ..... 51-53  
 3/4T, no holes, use only on 7 strip 8  
 board beds only 17.405 -0.15  
 ..... **\$168.25 EA** ⚠



**3713954** .....54-55  
 3/4T, no holes (55 1st series) 17.405 -0.15  
 ..... **\$168.25 EA** ⚠

## Rear Crossmember, cont.



**3810032** .....ALL  
 1/2T (specify year when ordering)  
 17.405 -0.4 ..... starting at **\$95.00 EA** ⚠

## Flange Bracket

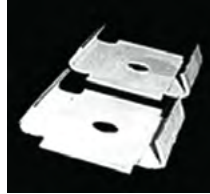

**3860566A** .....37-53  
 Flange Bracket. Crossmember. Sold as a  
 pair. 20.405 -0.3 ..... **\$15.50 PR** ⚠

## Tailpipe Heat Shield

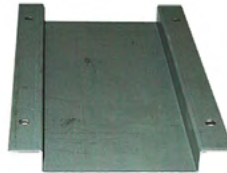

**3689481R** .....37-46  
 Under bed. 3.706 -0.15 ..... **\$9.75 EA** ⚠  
**3689481S** .....47-54  
 Under bed. 3.706 -0.15  
 ..... **\$8.50 EA** ⚠  
**3689481SS** .....47-54  
 Stainless steel. Under bed. 3.706 -0.15  
 ..... **\$16.00 EA** ⚠

## Tailgate

Note: Oversize shipping charges apply. Please  
 call for rates.



**471196** .....34-39  
 Complete w/out script, also GMC, original  
 1934-38. 46-1/2" wide. 17.615 -0.15  
**\$270.25 EA** ⚠

## Tailgate, cont.



**471196A** .....34-39  
 Chevrolet script, complete, original 1939.  
 46-1/2" wide. 17.615 -0.15 .. **\$319.50 EA**  
 ⚠

**3800262** ..... 40  
 Complete w/out script, also GMC. 49-1/2"  
 wide. 17.615 -0.15 ..... **\$270.25 EA** ⚠



**3800262D** ..... 40  
 Chevrolet script, complete. 49-1/2" wide.  
 17.615 -0.15 ..... **\$319.50 EA** ⚠



**3801850** .....41-46  
 Complete. Chevy/ GMC. 48-1/4" wide. No  
 Script. 17.615 -0.15 ..... **\$209.25 EA** ⚠



**3801850A** .....41-46  
 Skin no script. Fits GMC also. 49-1/4"  
 wide. 17.615 -0.15 ..... **\$81.25 EA** ⚠



**3801850L** .....41-46  
 Complete w/ louvers (7 rows w/ 6 louvers  
 each row) (also GMC). 17.615 -0.15 .....  
**\$313.00 EA** ⚠



**Tailgate, cont.**



**3806856** .....47-53  
Chevrolet script, complete. 17.615 -0.15  
**\$270.25 EA** ⚠

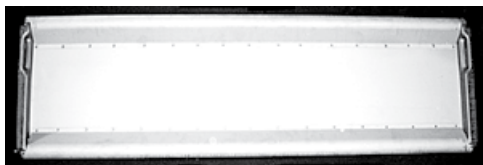

**3806856B** .....47-53  
Complete w/out script, also GMC.  
17.615 -0.15 ..... **\$209.25 EA** ⚠



**380685H** .....47-53  
GMC script, complete 17.615 -0.15 .....  
**\$270.25 EA** ⚠



**3810424** .....54-87  
Chevrolet script, complete. Fits Stepside.  
17.615 -0.15 ..... **\$319.50 EA** ⚠

**3810424A** .....54-87  
Complete w/out script, also GMC. Stepside  
only. 17.615 -0.15 ..... **\$209.00 EA** ⚠



**3810424B** .....54-87  
49 louvers. Complete (also fits GMC).  
Stepside only. 17.615 -0.15 .. **\$313.00 EA**  
⚠

**3810424G** .....54-87  
GMC script, complete for stepside.  
Note: Lettering is correct for 1963-1987  
17.615 -0.15 ..... **\$281.75 EA** ⚠

**Tailgate, cont.**

**3810424S** .....54-87  
Bowtie, complete, flush fit (double wall)  
Stepside, no latch 17.615 -0.15 .....  
**\$289.00 EA** ⚠

**Tailgate Cover**



**3806856HS** .....47-53  
Skin. No script. Also fits GMC. 17.615 -0.15  
..... **\$81.25 EA** ⚠



**3806856J** .....47-53  
Cover, hides the dents. 4 rows of louvers  
(also fits GMC). 17.615 -0.15 ..... **\$157.00 EA**  
⚠



**3806856M** .....54-87  
Cover 50-7/8" X 19-1/4" With Embossed  
Bowtie 31-1/2" X 10" 17.615 -0.15 .....  
**\$123.25 EA** ⚠



**810424C** .....54-87  
Cover, hides the dents. 7 rows of louvers.  
Stepside only 17.615 -0.15 .. **\$137.50 EA**  
⚠

**Tailgate Butcher Block**

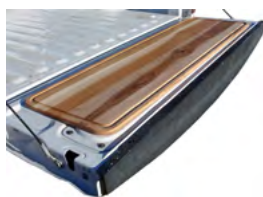

**BWTGFPS** .....ALL  
Tailgate butcher block, 54" X 27" X 1". -0  
..... **\$299.00 EA** ⚠

**Tailgate Decal**

**chevrolet** **3800262A**...39-40  
Chevrolet script,  
white 17.615 -0  
..... **\$13.25 EA** ⚠



**3800262B** .....39-40  
Chevrolet script, chrome 17.615 -0.15 ...  
**\$16.25 EA** ⚠

**3800262C** .....39-40  
Chevrolet script, black 17.615 -0.15  
..... **\$13.25 EA** ⚠

**3806856D** .....47-53  
Chevrolet script, white. 17.615 -0.15  
..... **\$12.50 EA** ⚠



**3806856E** .....47-53  
Chevrolet script, chrome. 17.615 -0.15 ...  
**\$14.00 EA** ⚠

**3806856F** .....47-53  
Chevrolet script, black. 17.615 -0.15  
..... **\$12.50 EA** ⚠

**3806856G** .....47-53  
GMC script, white. 17.615 -0  
..... **\$9.25 EA** ⚠

**3806856H** .....47-53  
GMC script, black. 17.615 -0  
..... **\$9.25 EA** ⚠



**3806856I** .....47-53  
GMC script, chrome. 17.615 -0.15 .....  
**\$15.00 EA** ⚠



**3810424D** .....54-57  
Chevrolet script, white 17.615 -0.15 .....  
**\$35.25 EA** ⚠

**3810424E** .....54-57  
Chevrolet script, black 17.615 -0.15  
..... **\$13.25 EA** ⚠

**3810424F** .....54-57  
Chevrolet script, chrome 17.615 -0.15  
..... **\$14.50 EA** ⚠

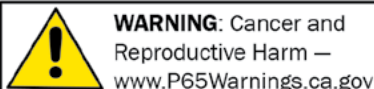

**WARNING:** Cancer and Reproductive Harm — www.P65Warnings.ca.gov

Chemicals shipped domestic ground only (Lower 48 states only). No international shipping.

Phone: (360) 816-0211 • (800) 999-CHEV (2438) • www.chevsofthe40s.com

490T

# Section 490T: Complete Bed & Bed Parts

## Tailgate Hinges



**463671** ..... **34-39**  
primed 17.625 -0.15 ..... **\$24.00 EA** ⚠

**3806884A** ..... **40**  
With bushing 17.625 -0.15  
..... **\$28.00 EA** ⚠

**3806884** ..... **41-53**  
Painted 17.625 -0.2  
..... **\$21.50 EA** ⚠



**3806884S** ..... **41-53**  
Chrome. 17.625 -0.15 ..... **\$55.75 PR** ⚠

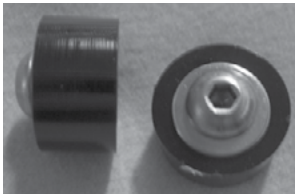

**3810706** ..... **54-87**  
Trunnion & bolt. stepside only 17.625 -0.15  
..... **\$37.00 PR** ⚠

## Tailgate Hinge Adapter



**SLEEVEN** ..... **40**  
Nylon adapter for  
use on 41-53 tailgate  
hinges to mount 1940  
tailgate (1940 larger

than 41-53 hinges). 17.625 -0.15  
..... **\$42.00 PR** ⚠

## Tailgate Chain Bracket



**3801845B** ..... **34-40**  
Right 17.635 -0.15  
..... **\$14.00 EA** ⚠



**3801845C** ..... **34-40**  
Left 17.635 -0.15  
..... **\$14.00 EA** ⚠

## Eye Bolt



**3801845D** ..... **34-53**  
Tailgate chain 17.635 -0.15 ..... **\$9.75 EA** ⚠

## Tailgate Chains



**3801845J** ..... **32-53**  
Assembly, zinc plated 17.635 -0.15 .....  
**\$25.00 PR** ⚠

**3801845S** ..... **32-53**  
Assembly, stainless 17.635 -0.15  
..... **\$56.75 PR** ⚠

**3810823** ..... **54-60**  
Assembly, zinc plated 17.635 -0.15  
..... **\$26.75 PR** ⚠

**3810823S** ..... **54-60**  
Assembly, stainless 17.635 -0.15  
..... **\$45.00 PR** ⚠

## Tailgate Chain Covers



**3810750** ..... **32-60**  
Black rubber 17.635 -0.15 ... **\$10.00 SET**  
⚠

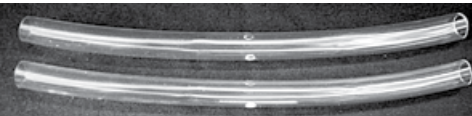

**3810750C** ..... **32-60**  
Clear rubber 17.635 -0.15 .. **\$8.00 PR** ⚠

## Spare Tire Carrier

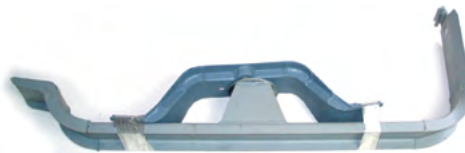

**358451** ..... **41-50**  
Assembly under bed 7.608 -0 ..... **CALL**  
⚠



**SECTION 520T  
RESTORATION PARTS**

**Engineering Feature Manual**



**ENG37M ..... 37**  
Engineering Feature Manual, Car & Truck  
18.300 -0.15  
..... **\$24.00 EA** ⚠



**ENG39M ..... 39**  
Engineering Feature Manual, Car & Truck  
18.300 -0.15  
..... **\$24.00 EA** ⚠



**ENG47M ..... 47**  
Engineering feature manual, Car & Truck  
18.300 -0.15  
..... **\$24.00 EA** ⚠



**ENG48M ..... 48**  
Engineering Feature Manual, Car & Truck  
18.300 -0.15  
..... **CALL** ⚠



**ENG49T ..... 49**  
Engineering Features Trucks Only Manual.  
18.300 -0.15  
..... **\$24.00 EA** ⚠



**ENG50T ..... 50**  
Engineering Features Trucks Only Manual.  
18.300 -0.15  
..... **\$24.00 EA** ⚠



**ENG52M ..... 52**  
Car & Truck 18.300 -0.15  
..... **\$24.00 EA** ⚠



**ENG53T ..... 53**  
Engineering features manual, Truck Only  
18.300 -0.15  
..... **\$24.00 EA** ⚠

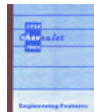

**ENG54T ..... 54**  
Truck Only 18.300 -0.2  
..... **\$15.00 EA** ⚠

**Sales Brochure**



**SALET ..... 37-55**  
Super color reproduction of original brochure (specify year when ordering)  
18.000 -0 ..... **starting at \$10.00 EA** ⚠

**Shop Manual on CD**



**SHOP37CD ..... 37-38**  
Car & truck on CD  
18.300 -0.15  
..... **\$30.75 EA** ⚠



**SHOP39CD ..... 39-40**  
Car & truck manuals on CD. 18.300 -0.15  
..... **\$30.75 EA** ⚠



**SHOP41CD ..... 41-48**  
41-48 Car & 41-46 Truck on CD. 18.300 -0.15  
..... **\$30.75 EA** ⚠



**SHOP47CD ..... 47-53**  
48-52 trucks.  
18.300 -0.15  
..... **\$30.75 EA** ⚠



**SHOP49CD ..... 49-54**  
49-54 Cars. 18.300 -0.15  
..... **\$30.75 EA** ⚠



**SHOP54CD ..... 54**  
54-55 (1st Series) Trucks on CD.  
18.300 -0.15  
..... **\$30.75 EA** ⚠

**Owners Manual**



**OWNT ..... 37-55**  
Specify year when ordering 18.000 -0.4  
.. **starting at \$12.00 EA** ⚠



**OWNTG ..... 41-55**  
GMC, specify year when ordering (exc 37-40 & 47-48). 18.000 -0.4  
..... **\$12.00 EA** ⚠

**Folder**



**OWNFD ..... ALL**  
For owners' manual & papers, Chevrolet Motor Division, original type  
18.000 -0.15  
..... **\$6.00 EA** ⚠

**Assembly Manual**



**ASS47 ..... 47-54**  
This truck manual has 550 pages of Incredible detail! A must have (original 54). 18.100 -0.15  
..... **\$36.00 EA** ⚠

**Bed Assembly**



**BED00 ..... ALL**  
& restoration manual.  
18.000 -0.15  
..... **\$4.75 EA** ⚠

**AC Parts Catalog**



**PARTAC41 ..... 29-41**  
Oil, fuel & air filters, speedometer cables  
18.200 -0.4  
..... **\$4.00 EA** ⚠

**Parts Book**



**PART39 ..... 29-42**  
For 42 & Earlier  
18.200 -0.15  
..... **\$50.00 EA** ⚠



**PART50 ..... 29-50**  
For 50 & Earlier  
18.200 -0.15  
..... **\$64.75 EA** ⚠



**PART54 ..... 29-54**  
Chevrolet Master Parts and Accessories catalog, reprint.  
18.200 -0.15  
..... **\$75.25 EA** ⚠



**PART57 ..... 29-57**  
Chevrolet Body Parts and Accessories Catalog 18.200 -0.15  
..... **\$75.25 SET** ⚠



**PART42W ..... 35-41**  
Woody wagon & Suburban 18.200 -0.3  
..... **\$10.00 EA** ⚠



**PART48W ..... 42-48**  
Suburban 18.200 -0.15  
..... **\$27.50 EA** ⚠

**WARNING:** Cancer and Reproductive Harm — [www.P65Warnings.ca.gov](http://www.P65Warnings.ca.gov)

Chemicals shipped domestic ground only (Lower 48 states only). No international shipping.

**Phone: (360) 816-0211 • (800) 999-CHEV (2438) • www.chevsofthe40s.com**

**Parts Interchange**



**PART51N.....29-52**  
Chev, Pontiac,  
Oldsmobile 18.200 -0.15  
..... **\$24.00 EA** ⚠

**Books**



**BOOK12V .....ALL**  
6v to 12v conversion  
19.500 -0.15  
..... **\$12.00 EA** ⚠



**GASBOOK01.....ALL**  
Title of this book "The  
Official Guide to Modern  
Gasoline & Oil for  
Antique Vehicles" says

it all. 19.500 -0.15

..... **\$15.00 EA** ⚠



**HOTSTARTBOOK...ALL**  
Each of us has owned,  
or knows of someone  
who has owned an  
antique vehicle, muscle

car, or hot rod that refuses to start  
when the engine is warm. To make this  
more aggravating, the vehicle seems  
to start fine when the engine is cold. In  
this book Randy will help you to identify  
and fix your hot start problem once and  
for all. 68 pages with color illustrations  
throughout. -0.15

..... **\$17.25 EA** ⚠

**Shop Manuals on CD**

All CDs contain the factory service or shop  
manual and any applicable supplement.  
The factory manual is essential. It includes  
coverage on all mechanical and electrical  
systems. This is where you find specifications,  
wiring diagrams, diagnostic procedures,  
troubleshooting, installation and removal, and  
covers all systems.

CDs contain the body service manual as  
well. In some cases, the body information is  
included in the service manual.  
Parts books are included on most CDs; check  
content information for specifics.

**Shop & Service Manuals on CD**



**DCDGM-51..... 37**  
Includes 1937 shop manual, 29-48 parts  
book for 1937 cars & trucks. 18.300 -0.3  
..... **\$35.00 EA** ⚠

**DCDGM-52..... 38-38**  
Includes 1938 shop manual, 29-48 parts  
book & 38-68 parts book for 1938 cars &  
trucks. 18.300 -0.3  
..... **\$35.00 EA** ⚠

**DCDGM-53..... 39**  
Includes 1939 shop manual, 39-40  
Fisher body manual, 29-48 parts book &  
38-68 parts book for 1939 cars & trucks.  
18.300 -0.3  
..... **\$35.00 EA** ⚠

**DCDGM-55..... 41**  
Includes 1941 shop manual, 29-48 parts  
book & 38-68 parts book for 1941 cars &  
trucks. 18.300 -0.3  
..... **\$35.00 EA** ⚠

**DCDGM-56..... 42-48**  
Includes 1942-48 shop manual, 29-48  
parts book & 38-68 parts book for 1942-  
48 cars & 42-48 trucks. 18.300 -0.2  
..... **\$55.00 EA** ⚠

**DCDGM-74..... 47**  
Includes 1947 shop manual, 29-48  
parts book, 38-68 parts book & 47-  
55 assembly manual for 1947 trucks.  
18.300 -0.4  
..... **\$55.00 EA** ⚠

**DCDGM-75..... 48-53**  
Includes 1948-53 shop manual, 29-48  
parts book, 38-68 parts book & 47-55  
assembly manual for 1948-53 trucks.  
18.300 -0.3  
..... **\$35.00 EA** ⚠

**DCDGM-76..... 54**  
Includes 1954 shop manual, 49-58 parts  
book & 54-65 parts book for 1954 trucks.  
18.300 -0.3  
..... **\$35.00 EA** ⚠

**Parts Book on CD**

**PART61CD.....29-61**  
29-61 Cars, Trucks & 53-61 Corvette.  
18.200 -0.15  
..... **\$30.75 EA** ⚠

**Parts Book on CD, cont.**

**DCDGM-145.....29-72**  
29-72 parts book. 18.300 -0.3  
..... **\$35.00 EA** ⚠



**PART72CD .....38-72**  
38-64 Cars, 38-  
72 Trucks & 53-64  
Corvette. 18.200 -0.15  
..... **\$30.75 EA** ⚠

**Shop Manual**



**SHOP37..... 37**  
Car & truck, full size.  
Superb! 18.300 -0.15  
..... **\$24.00 EA** ⚠



**SHOP38..... 38**  
W/ car & truck, full size.  
Superb! 18.300 -0.15  
..... **\$24.00 EA** ⚠



**SHOP38P..... 38**  
W/ car & truck,  
3/4 size photocopy  
18.300 -0  
..... **CALL** ⚠



**SHOP39..... 39**  
W/ car & truck, full size.  
Superb! 18.300 -0.15  
..... **\$24.00 EA** ⚠



**SHOP40..... 40**  
W/ car & truck, full size.  
Superb! 18.300 -0.15  
..... **\$24.00 EA** ⚠



**SHOP41..... 41**  
W/ car & truck, full size.  
Superb! 18.300 -0.15  
..... **\$24.00 EA** ⚠



**SHOP42..... 42-48**  
Car & 42-46 truck, full  
size. Superb! 18.300 -0.15  
..... **\$24.00 EA** ⚠



**SHOP47T..... 47**  
Original Shop Manual  
1947 Only 18.300 -0.15  
..... **\$39.00 EA** ⚠



**SHOP47..... 47-53**  
Original 48-52, full size.  
Superb! 18.300 -0.15  
..... **\$24.75 EA** ⚠





**Shop Manual, cont.**



**SHOP47G . . . . . 47-54**  
GMC, full size. Superb!  
18.300 -0.15  
..... **\$30.00 EA** ⚠



**SHOP54 . . . . . 54**  
Full size. Superb!  
18.300 -0.15  
..... **\$24.75 EA** ⚠

**Shop Supplement**



**SHOP55 . . . . . 55**  
1st series, full size  
18.300 -0.15  
..... **\$10.75 EA** ⚠

**Good Housekeeping**



**HOUS1 . . . . . ALL**  
In your car by GM,  
Fisher body, removing  
17 upholstery stains,  
29 pages 18.230 -0.3  
..... **\$6.25 EA** ⚠

**Service Bulletins**

Note: 1 service bulletin was issued every month (except during WWII) to Chevrolet dealers on fixing new car problems. Introduction issue is previous year so we recommend three years for complete coverage of your vehicle. Invaluable.



**SERV . . . . . 37-54**  
12 month, specify  
year when ordering  
18.500 -0.15  
.. starting at **\$20.00 EA** ⚠

**Glove Box Accessory Book**



**ACC37B . . . . . 37**  
Color repro of original  
w/ pictures of all those  
rare accessories.  
18.600 -0.15  
..... **\$14.00 EA** ⚠



**ACC38B . . . . . 38**  
Repro of original w/  
pictures of all those  
rare accessories. Sepia,  
9in. x 11in. 18.600 -0.15  
..... **\$14.00 EA** ⚠



**ACC39B . . . . . 39**  
Color repro of original  
w/ pictures of all those  
rare accessories.  
18.600 -0.15  
..... **\$14.00 EA** ⚠

**Glove Box Accessory Book, cont.**



**ACC40B . . . . . 40**  
Color repro of original  
w/ pictures of all those  
rare accessories.  
18.600 -0.15  
..... **\$14.00 EA** ⚠



**ACC41B . . . . . 41**  
Color repro of original  
w/ pictures of all those  
rare accessories.  
18.600 -0.15  
..... **\$14.00 EA** ⚠



**ACC48B . . . . . 46-48**  
Color repro of original  
w/ pictures of all those  
rare accessories.  
Original 48. 18.600 -0.15  
..... **\$14.00 EA** ⚠

**Accessory Identifying Book**



**ACC01B . . . . . 46-78**  
All accessories 1946-  
78 in numerical order,  
superb for identifying.  
18.600 -0.15  
..... **\$25.00 EA** ⚠

**Accessory List**

**ACC\_L . . . . . 37-54**  
With part numbers & prices (great for  
swap meets) (specify year after "ACC").  
18.700 -0.4  
..... starting at **\$5.00 EA** ⚠

**Data Book**

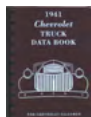

**DATA41 . . . . . 41-46**  
Salesman, all the  
specs, original 1941  
18.800 -0.15  
..... **\$36.75 EA** ⚠



**DATA51 . . . . . 47-53**  
Salesman, all the  
specs, original 1950  
18.800 -0.15  
..... **\$45.25 EA** ⚠



**DATA54 . . . . . 54**  
Salesman, all the specs  
1954 18.800 -0.15  
..... **\$34.50 EA** ⚠

**RPO Booklet**



**RP047 . . . . . 47**  
W/ regular production  
options 18.800 -0.15  
..... **\$5.00 EA** ⚠



**RP049 . . . . . 49**  
W/ regular production  
options 18.800 -0.15  
..... **\$5.00 EA** ⚠



**RP053 . . . . . 53**  
W/ regular production  
options 18.800 -0.15  
..... **\$5.00 EA** ⚠



**RP054 . . . . . 54**  
W/ regular production  
options 18.800 -0.2  
..... **\$6.50 EA** ⚠

**Price Guide**



**PRICE37 . . . . . 37**  
Advertised delivered  
prices of vehicles &  
accessories 18.700 -0.15  
..... **\$3.25 EA** ⚠



**PRICE38 . . . . . 38**  
Advertised delivered  
prices of vehicles &  
accessories 18.700 -0.15  
..... **\$5.50 EA** ⚠



**PRICE39 . . . . . 39**  
Advertised delivered  
prices of vehicles &  
accessories 18.700 -0.15  
..... **\$3.25 EA** ⚠

**Casting Numbers**



**CAST42 . . . . . 29-42**  
Identification book  
18.600 -0.15  
..... **\$10.00 EA** ⚠

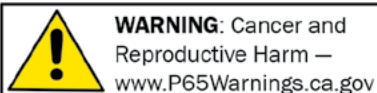

Chemicals shipped domestic ground only (Lower 48 states only). No international shipping.

**Phone: (360) 816-0211 • (800) 999-CHEV (2438) • [www.chevsofthe40s.com](http://www.chevsofthe40s.com)**

**SECTION 530T  
RESTORATION PARTS**

**Accessory Installation Manual**

Copies of originals wanted: Original accessory instruction sheets 1937-54 or sharp copies.

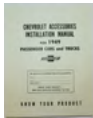

**ACC49M . . . . . 49**  
Superb 18.900 -0.15

..... **\$14.00 EA** ⚠

**ACC49E . . . . . 49-54**  
Per accessory 18.900 -0

..... **CALL** ⚠



**ACC50M . . . . . 50**  
Superb 18.900 -0.15

..... **\$12.00 EA** ⚠



**ACC51M . . . . . 51**  
Superb 18.900 -0.15

..... **\$12.00 EA** ⚠



**ACC52M . . . . . 52**  
Superb 18.900 -0.15

..... **\$14.50 EA** ⚠



**ACC53M . . . . . 53**  
Superb 18.900 -0.15

..... **\$12.00 EA** ⚠



**ACC54M . . . . . 54**  
Superb 18.900 -0.15

..... **\$14.00 EA** ⚠

**Antenna Installation Sheets**



**ACC65I . . . . . 37-40**  
Under running board  
(original 40) 18.900 -0.15

..... **\$2.00 EA** ⚠



**985531I . . . . . 39-46**  
Install instructions  
18.900 -0.4

..... **\$2.00 EA** ⚠

**ACC76I . . . . . 47-54**  
Includes template 18.900 -0.15

..... **\$2.00 EA** ⚠

**Cigarette Lighter Installation Sheet**

**ACC45I . . . . . 42-53**  
This is a nice reproduction of the original  
cigar / cigarette lighter installation sheet.  
18.900 -0.15

..... **\$2.00 EA** ⚠

**Compass Installation Sheets**

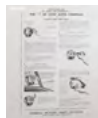

**ACC25I . . . . . 37-42**  
For glove box 18.900 -0.3

..... **\$2.00 EA** ⚠

**ACC26I . . . . . 46-48**  
For glove box 18.900 -0.3

..... **\$2.00 EA** ⚠

**Fog Light Installation Sheets**



**ACC18I . . . . . 41**  
This is a nice  
reproduction of the  
original fog light  
installation sheets.  
18.900 -0.3

..... **\$2.00 EA** ⚠

**ACC40I . . . . . 42-48**  
This is a nice reproduction of the original  
fog light installation sheets. 18.900 -0.15

..... **\$2.00 EA** ⚠

**Gas Filter Installation Sheet**

**ACC56I . . . . . 33-56**  
Genuine AC 18.900 -0.15

..... **\$2.00 EA** ⚠

**Glove Compartment Lamp  
Installation Sheet**

**ACC02I . . . . . 41-54**  
This is a nice reproduction of the original  
glove compartment lamp/light installation  
sheet. 18.900 -0.15

..... **\$1.00 EA** ⚠

**Heater & Defroster Installation  
Sheet**

**ACC24I . . . . . 37-46**  
(deluxe) Original 42-46 18.900 -0.15

..... **\$1.00 EA** ⚠

**ACC23I . . . . . 47-48**  
Non-fresh air, also COE 18.900 -0.3

..... **\$2.00 EA** ⚠

**Heater Installation Sheet**

**ACC47I . . . . . 47-53**  
Recirculating, 3000-4000-6000 series  
18.900 -0.15

..... **\$2.00 EA** ⚠

**ACC61I . . . . . 47-53**  
Recirculating 18.900 -0.4

..... **\$2.00 EA** ⚠

**Horn Installation Sheet**



**ACC62I . . . . . 37-38**  
(Matched) with City &  
Country switch, original  
37 19.900 -0.4

..... **\$2.50 EA** ⚠

**ACC09I . . . . . 37-39**  
(Matched) with City & Country switch,  
original 39 18.900 -0.4

..... **\$2.50 EA** ⚠

**Town & Country Horn Installation  
Sheet**

**ACC10I . . . . . 40-42**  
This is a nice reproduction of the original  
Town and Country horn installation sheet.  
18.900 -0.4

..... **\$3.00 EA** ⚠

**Lock & Key Service Manual**

**ACC89I . . . . . ALL**  
9 pages 18.900 -0.4

..... **\$5.00 EA** ⚠

**Vanity Mirror Installation Sheet**

**ACC63I . . . . . 37-41**  
With vertical lights 18.900 -0.15

..... **\$2.00 EA** ⚠

**Peep Mirror Installation Sheet**

**ACC53I . . . . . 37-50**  
This is a nice reproduction of the original  
'peep' mirror installation sheet. 18.900 -0.4

..... **\$1.00 EA** ⚠

**Oil Filter Installation Sheet**

**ACC88I . . . . . 37-41**  
Original AC 18.900 -0.4

..... **\$3.00 EA** ⚠



**ACC66I . . . . . 42-47**  
Original AC 18.900 -0.3

..... **\$4.00 EA** ⚠



**ACC87I . . . . . 48-49**  
Original AC 18.900 -0.2

..... **\$3.00 EA** ⚠



**ACC67I . . . . . 50-52**  
Original AC 18.900 -0.15

..... **\$2.00 EA** ⚠



**ACC68I . . . . . 53-55**  
Original AC 18.900 -0.15

..... **\$2.00 EA** ⚠

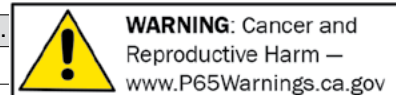

**Overflow Tank Installation Sheet**

**ACC07I** .....37-48  
 Install instructions 18.900 -0.3  
 ..... **\$2.00 EA** ⚠

**ACC08I** .....49-54  
 This is a nice reproduction of the original overflow tank (radiator) installation sheet. 18.900 -0.3  
 ..... **\$2.00 EA** ⚠

**Park Light Installation Sheet**



**ACC60I** .....37-39  
 Fender lamps 18.900 -0.15  
 ..... **\$2.00 EA** ⚠

**Passing Lamp Installation Sheet**

**ACC19I** ..... 41  
 This is a nice reproduction of the original passing lamp / light installation sheet. 18.900 -0.3  
 ..... **\$2.00 EA** ⚠

**Radiator Insect Screen Installation Sheet**



**ACC71I** .....47-53  
 This is a nice reproduction of the original radiator insect screen installation

sheet. 18.900 -0.15  
 ..... **\$2.00 EA** ⚠

**Radio Manual**

**ACC43I** .....36-47  
 18.900 -0  
 ..... **\$1.00 EA** ⚠

**985538M** ..... 40  
 5 tube, 4 button (original 40). 18.900 -0.4  
 ..... **\$3.00 EA** ⚠



**986067M** .....47-50  
 Original 47 18.900 -0.4  
 ..... **\$6.00 EA** ⚠

**986771M** ..... 54  
 This is a nice reproduction of the original radio manual. 18.900 -0.4  
 ..... **\$6.00 EA** ⚠

**Radio Shop & Service Manual**



**ACC44I** .....47-53  
 Original 50 18.900 -0.15  
 ..... **\$9.75 EA** ⚠

**Sunvisor**

**ACC57I** .....ALL  
 Application chart for Fulton exterior visor. 18.900 -0.15  
 ..... **\$2.00 EA** ⚠

**Spotlight Template**



**ACC39I** .....37-54  
 W/ instruction 18.900 -0.15  
 ..... **\$2.00 EA** ⚠

**AST** .....39-46  
 W/ Instruction 0.000 -0.2  
 ..... starting at **\$2.50 EA** ⚠

**Umbrella Holder Installation Sheet**

**ACC11I** .....ALL  
 This is a nice reproduction of the original umbrella holder installation sheet. 18.900 -0.3  
 ..... **\$2.00 EA** ⚠

**Underhood Lamp Installation Sheet**

**ACC82I** .....49-54  
 This is a nice reproduction of the original under hood lamp installation sheet. 18.900 -0  
 ..... **\$1.00 EA** ⚠

**Utility Pocket Unit Installation Sheet**



**ACC70I** .....48-50  
 This is a nice reproduction of the original utility pocket unit installation sheet.

18.900 -0.15  
 ..... **\$2.00 EA** ⚠

**Windshield Washer Installation Sheet**

**ACC59I** .....38-39  
 This is a nice reproduction of the original windshield washer installation sheet. 18.900 -0.15  
 ..... **\$2.00 EA** ⚠

**ACC12I** .....40-42  
 This is a nice reproduction of the original windshield washer installation sheet. 18.900 -0.3  
 ..... **\$2.00 EA** ⚠

**Windshield Wiper Installation Sheet**



**ACC72I** .....39-46  
 Right 18.900 -0.15  
 ..... **\$2.00 EA** ⚠

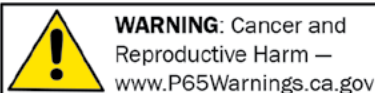

**WARNING:** Cancer and Reproductive Harm — [www.P65Warnings.ca.gov](http://www.P65Warnings.ca.gov)

Chemicals shipped domestic ground only (Lower 48 states only). No international shipping.

**Phone: (360) 816-0211 • (800) 999-CHEV (2438) • [www.chevsofthe40s.com](http://www.chevsofthe40s.com)**

**SECTION 550T  
RESTORATION PARTS**

**Signs**



**SIGN03** ..... **ALL**  
Chevrolet decal (as on metal sign).  
19.450 -0.15 ..... **\$15.75 EA** ⚠️

**Air Cleaner**



**AIR350** ..... **34-39**  
Oil bath decal  
19.300 -0.15 ..... **\$3.50 EA** ⚠️



**AIR37** ..... **37**  
Dry decal 19.300 -0 ..... **\$5.50 EA** ⚠️

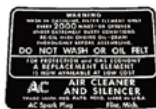

**AIR38T** ..... **38-46**  
Dry decal 19.300 -0.2 ..... **\$12.75 EA** ⚠️



**AIR400T** ..... **40-54**  
Oil bath decal  
19.300 -0.15 ..... **\$10.00 EA** ⚠️



**AIR47T** ..... **47-54**  
Dry decal 19.300 -0.15 ..... **\$3.00 EA** ⚠️



**AIR470T** ..... **47-59**  
Oil bath decal, heavy  
duty 19.300 -0 ..... **\$4.75 EA** ⚠️

**Antifreeze**



**TAG10** ..... **ALL**  
GM tag 19.100 -0.2 ..... **\$13.50 EA** ⚠️

**Battery**



**TAG03** ..... **ALL**  
Guarantee card  
19.100 -0.15 ..... **\$4.75 EA** ⚠️

**Break-in Instructions**



**TAG01** ..... **39-47**  
Card 19.100 -0.15 ..... **\$4.00 EA** ⚠️



**TAG11** ..... **48-56**  
Card 19.100 -0.15 ..... **\$4.50 EA** ⚠️

**Cigar Lighter**



**TAG02** ..... **39-50**  
Card-Casco 19.100 -0.15 ..... **\$4.00 EA** ⚠️

**Compass**



**TAG23** ..... **37-42**  
Tag (cut in outline of  
compass) 19.100 -0.2 ..... **\$2.50 EA** ⚠️

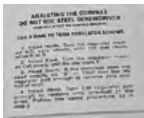

**DEC12** ..... **37-59**  
Instruction decal  
19.200 -0.15 ..... **\$3.00 EA** ⚠️

**Data Plate (Metal)**



**PLATE39T** ..... **39-41**  
Right side cowl 1/2T  
19.400 -0.15 ..... **\$23.50 EA** ⚠️



**PLATE42T** ..... **42-46**  
Right side cowl 1/2T  
19.400 -0.15 ..... **\$23.75 EA** ⚠️



**PLATE47T** ..... **47-49**  
Door post 1/2T  
19.400 -0.15 ..... **\$22.25 EA** ⚠️



**PLATE50G** ..... **50**  
Door post 1/2T, GMC  
19.400 -0.15 ..... **\$18.00 EA** ⚠️



**PLATE50T** ..... **50**  
Door post 1/2T  
19.400 -0.15 ..... **\$15.99 EA** ⚠️



**PLATE51T** ..... **51-52**  
Door post 1/2T  
19.400 -0.15 ..... **\$22.25 EA** ⚠️

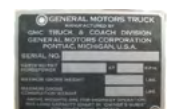

**PLATE53G** ..... **53**  
Door post 1/2T, GMC  
19.400 -0.15 ..... **\$22.25 EA** ⚠️

**Data Plate (Metal), cont.**



**PLATE53T** ..... **53**  
Door post 1/2T  
19.400 -0.15 ..... **\$22.25 EA** ⚠️



**PLATE54G** ..... **54**  
Door post 1/2T, GMC  
19.400 -0.15 ..... **\$18.00 EA** ⚠️



**PLATE54T** ..... **54**  
Door post 1/2T  
19.400 -0.15 ..... **\$22.25 EA** ⚠️

**Delco Remy Metal Tag**



**PLATE07** ..... **37**  
Generator, starter & distributor  
19.400 -0.15 ..... **\$7.00 EA** ⚠️

**Delco Remy Tag**



**PLATE05** ..... **38-54**  
Generator, Starter or Distributor. Includes  
rivets. 19.400 -0.15 ..... **\$7.00 EA** ⚠️

**Generator Warning Tag**



**TAG04** ..... **ALL**  
This is a nice  
reproduction of the  
warning tag that was  
originally installed on  
the generator. 19.100 -0.3 ..... **\$3.00 EA** ⚠️

**Heater**



**DEC07** ..... **47-52**  
Chevrolet round  
emblem. 19.200 -0.15 ..... **\$26.25 EA** ⚠️



**DEC08** ..... **47-52**  
GMC round emblem.  
19.200 -0.15 ..... **\$30.00 EA** ⚠️







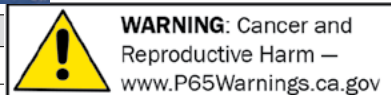

**DEC06** ..... **47-55**  
On/off defroster decal.  
19.200 -0.15 ..... **\$3.00 EA** ⚠️

Returns require a return authorization number—call first. • Product pricing & availability subject to change.



**Heater, cont.**

-  **DEC29** ..... **49-51**  
Decal-Harrison  
19.200 -0.15  
..... **\$9.00 EA** ⚠️
-  **DEC09** ..... **53**  
Fresh air round decal.  
19.200 -0.15  
..... **\$6.00 EA** ⚠️
-  **DEC17** ..... **53**  
Recirculating round  
decal. 19.200 -0.15  
..... **\$3.75 EA** ⚠️
-  **DEC10** ..... **53-54**  
GMC round decal.  
19.200 -0.15  
..... **\$4.75 EA** ⚠️
-  **DEC16** ..... **54-55**  
Fresh air round decal.  
19.200 -0.15  
..... **\$6.00 EA** ⚠️
-  **DEC18** ..... **54-55**  
Recirculating round  
decal. 19.200 -0.15  
..... **\$5.25 EA** ⚠️

**Key Decal**

-  **DEC11** ..... **36-54**  
Glove box 19.200 -0.2  
..... **\$4.50 EA** ⚠️

**Lubrication Sticker**

-  **DEC05** ..... **ALL**  
Chevrolet script  
(blue, yellow & white)  
19.200 -0.15  
..... **\$3.00 SET** ⚠️

**Mirror Glare Proof**



front side      back side

- TAG09** ..... **ALL**  
Day-night card hangs on mirror arm (nice!)  
19.100 -0.2 ..... **\$2.50 EA** ⚠️

**Oil Filter**



- DEC30** ..... **37-41**  
Decal. Original, AC Kleer Kleen 19.200 -0.15  
..... **\$9.75 EA** ⚠️



- DEC19** ..... **40-49**  
Decal set (1940's) Fram 3-piece  
19.200 -0.15 ..... **\$8.00 EA** ⚠️



- DEC04** ..... **42-54**  
Decals-set of 2, original AC 19.200 -0  
..... **\$5.25 EA** ⚠️



- DEC20** ..... **50-59**  
Decal set (1950's) Fram 4-piece  
19.200 -0.15 ..... **\$9.50 EA** ⚠️

**Overflow Tank Decal**



- DEC03** ..... **39-48**  
Gold with red wings. 19.200 -0.4  
..... **\$5.00 EA** ⚠️

**Overflow Tank Decal, cont.**



- DEC28** ..... **49-54**  
Clear with orange lettering. 19.200 -0.15  
..... **\$9.00 EA** ⚠️

**Paint Lacquer**

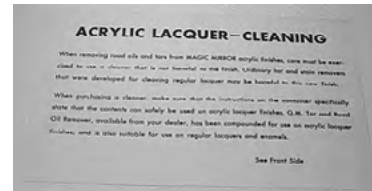

- TAG16** ..... **53-58**  
Instruction card 19.100 -0.2  
..... **\$6.00 EA** ⚠️

**Quality Control Card**



- TAG15** ..... **49-54**  
Reproduction  
of the 1949-54  
quality control card.  
19.100 -0.2  
..... **\$12.00 EA** ⚠️

**Service Policy**



- TAG25** ..... **37-51**  
Reproduction  
of the 1937-51  
service policy card.  
19.100 -0.2  
..... **\$5.99 EA** ⚠️



- TAG13** ..... **51-59**  
Reproduction  
of the 1951-59  
service policy card.  
19.100 -0.15  
..... **\$4.00 EA** ⚠️



**WARNING:** Cancer and Reproductive Harm — [www.P65Warnings.ca.gov](http://www.P65Warnings.ca.gov)

Chemicals shipped domestic ground only (Lower 48 states only). No international shipping.

**Phone: (360) 816-0211 • (800) 999-CHEV (2438) • [www.chevsofthe40s.com](http://www.chevsofthe40s.com)**

**Spotlight Card**



**TAG08 . . . . .37-54**  
Original S3-S4 hung  
on light 19.100 -0.4  
  
..... **\$3.00 EA** ⚠

**Tire Pump Decal**



**DEC34. . . . .ALL**  
For hard to find genuine Chevrolet  
accessory. By Monroe -0.2 **\$5.00 EA** ⚠

**Valve Cover Decal**



**DEC15. . . . .47-53**  
Thriftmaster for 216ci 19.200 -0.15  
**\$6.00 EA** ⚠



**DEC25. . . . .54**  
Thriftmaster 235ci 19.200 -0.15  
**\$6.00 EA** ⚠

**Warranty Card**



**TAG14 . . . . .54-60**  
Reproduction of  
an impossible to  
find warranty card.  
19.100 -0.15  
..... **\$4.00 EA** ⚠

**Windshield Washer**



**DEC02 . . . . .39-50**  
Decal on metal  
basket 19.200 -0.15  
..... **\$4.00 EA** ⚠



**DEC13. . . . .51-54**  
Lid decal 19.200 -0.15  
..... **\$9.00 EA** ⚠



**DEC14 . . . . .51-54**  
Basket decal  
19.200 -0.15  
..... **\$9.00 EA** ⚠



**SECTION 560T  
RESTORATION PARTS**

**Hemmings Collector Car  
Encyclopedia**

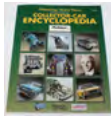

**HEMMINGPEDIA . .ALL**  
Hemmings Collector Car  
Encyclopedia -0.15  
..... **\$14.00 EA** ⚠



**WARNING:** Cancer and  
Reproductive Harm —  
[www.P65Warnings.ca.gov](http://www.P65Warnings.ca.gov)

Chemicals shipped domestic ground only (Lower 48 states only). No international shipping.

**Phone: (360) 816-0211 • (800) 999-CHEV (2438) • [www.chevsofthe40s.com](http://www.chevsofthe40s.com)**

**A**

AC .....53  
 AC VENTS .....53  
 ADHESIVES & SEALERS.....26-27, 157  
 AIR CLEANERS ..... 94-95, 242  
 AIR CONDITIONING.....53  
 AIR FILTERS .....95-96  
 ALTERNATORS..... 60-61  
 ALUMINUM BUNDLE STRAP ..... 56, 72  
 ANTENNAS .....198-199  
 ARM RESTS.....211  
 ASH TRAYS .....190  
 AUTO LITERATURE ..... 70, 237-239, 245  
 AC .....53  
 AC VENTS .....53  
 ADHESIVES & SEALERS.....26-27, 157  
 AIR CLEANERS ..... 94-95, 242  
 AIR CONDITIONING.....53  
 AIR FILTERS .....95-96  
 ALTERNATORS..... 60-61  
 ALUMINUM BUNDLE STRAP ..... 56, 72  
 ANTENNAS .....198-199  
 ARM RESTS.....211  
 ASH TRAYS .....190  
 AUTO LITERATURE ..... 70, 237-239, 245

**B**

BACK GLASS..... 215-217, 226  
 BACKUP LIGHTS .....77-78, 93  
 BALLAST RESISTOR .....65  
 BATTERY & RELATED ..... 25, 28, 61, 63-64, 180, 242  
 BEAUTY RINGS .....141  
 BED ..... 88, 229-231  
 BED ROLL LIGHTS .....88  
 BILLET.....195  
 BODY BOLT KITS.....176  
 BODY MOUNTING COMPONENTS .....175  
 BOLT LOOSENER .....27  
 BRAKE CLEANER .....26  
 BRAKE FLUID ..... 26, 125  
 BRAKE HOSE .....121  
 BRAKE LIGHTS ..... 92, 124  
 BRAKE LINES ..... 122, 124  
 BRAKE OVERHAUL KITS.....119  
 BRAKE PEDALS..... 120, 181  
 BRAKES & RELATED..... 119-121, 124  
 BULBS..... 73, 76, 85-87

BULK TUBING .....28  
 BUMPER BOLTS .....148  
 BUMPER BRACKETS ..... 146, 148  
 BUMPER GUARDS .....148

**C**

CAB MOUNT .....175  
 CAM & LIFTER KITS ..... 35-36  
 CAMSHAFTS .....39  
 CARBURETOR CLEANER .....28  
 CARBURETORS.....100-101  
 CAR CARE ..... 21-24  
 CARPET & RELATED .....179  
 CAR WASH,WAX,CLEANERS.....23  
 CHOKE CABLES .....189  
 CHOKE KNOBS.....189  
 CIGARETTE LIGHTERS ..... 190, 242  
 CIGAR LIGHTERS .....242  
 CLAMP-WIRE.....70  
 CLIPS-LINE .....124  
 CLIPS-WIRE.....72  
 CLOTHING..... 17-18  
 CLUTCH HEAD DRIVER..... 82, 159, 184, 208  
 CLUTCH HEAD SCREWS..... 82, 210  
 CLUTCH HEAD SOCKET SET..... 27, 159, 184, 208  
 CLUTCH PEDALS.....181  
 CLUTCH & RELATED .....109  
 COLLECTIBLES .....15, 18-21  
 CONDENSERS .....66  
 CORE SUPPORTS .....154  
 COWL VENTS ..... 55-56, 188, 204-205  
 CRANK HOLE COVER .....151-152  
 CROSSMEMBER.....47  
 CURB FEELERS.....161

**D**

DASH & RELATED ..... 193, 195-196  
 DECALS.....242-244  
 DEFROSTER ..... 54, 56  
 DIMMER SWITCH .....84  
 DISC BRAKES .....118  
 DISTRIBUTORS ..... 65-66  
 DOME LIGHTS.....186  
 DOOR ..... 185-186, 208-210, 212-214, 216, 223  
 DOOR BUMPERS .....214  
 DOOR CHECK LINKS .....212  
 DOOR GLASS & RELATED .....216



DOOR HANDLES . . . . . 208, 210  
 DOOR HINGES . . . . . 212  
 DOOR LATCHES . . . . . 209-210, 214  
 DOOR LOCKS . . . . . 209  
 DOOR PANELS . . . . . 185-186, 208-209  
 DOOR PULLS . . . . . 208  
 DOOR PUSHBUTTONS . . . . . 208  
 DOOR SILLS . . . . . 213  
 DOOR WEATHERSTRIP . . . . . 213-214  
 DOOR WINDOW COMPONENTS . . . . . 223  
 DRAG LINKS . . . . . 130  
 DRIVE SHAFTS . . . . . 114  
 DRIVING LIGHTS . . . . . 77, 86

**E**

EMERGENCY BRAKES . . . . . 119-120, 188  
 ENGINE ASSEMBLY LUBE . . . . . 42, 46  
 ENGINE BOLT KITS . . . . . 41  
 ENGINE COMPONENTS . . . . . 37-42  
 ENGINE GASKETS & SEALS . . . . . 45-46  
 ENGINE HAND CRANK . . . . . 58  
 ENGINE KITS . . . . . 35  
 EXHAUST . . . . . 41, 102, 104-107, 183, 202  
 EXHAUST MANIFOLDS . . . . . 41, 102, 105  
 EXHAUST & RELATED . . . . . 104-107, 183, 202

**F**

FAN . . . . . 54, 188  
 FANS . . . . . 51  
 FENDER MOULDINGS . . . . . 160  
 FENDERS . . . . . 15, 159-161  
 FIREWALL . . . . . 173, 177-178  
 FIREWALL & RELATED . . . . . 177-178  
 FLASHLIGHT . . . . . 186  
 FLOORBOARDS . . . . . 111, 179-180  
 FLOOR MAT . . . . . 179  
 FLYWHEEL RING GEAR . . . . . 109  
 FOG LIGHTS . . . . . 77-78, 87  
 FOG LIGHT SWITCH . . . . . 93  
 FRONT BUMPERS . . . . . 146-147, 149  
 FRONT SUSPENSION . . . . . 132-134  
 FUEL LINES . . . . . 96, 98, 101  
 FUEL PUMPS . . . . . 96, 99-100, 204  
 FUEL SENDING UNITS . . . . . 97-98  
 FUEL STABILIZERS . . . . . 26, 95  
 FUEL SYSTEM . . . . . 94, 98-99  
 FUSE HOLDER . . . . . 78

**G**

GARNISH MOULDINGS . . . . . 222  
 GAS . . . . . 25, 27, 94, 96-99, 180  
 GAS CAPS . . . . . 94, 99  
 GAS FILLER . . . . . 94, 98  
 GASKET SEALER . . . . . 46  
 GAS PEDALS . . . . . 180  
 GAS SHUT OFF VALVE . . . . . 98  
 GAS TANK PREP & SEALER . . . . . 96  
 GAS TANK RESTORATION KIT . . . . . 25  
 GAS TANKS . . . . . 25, 96-98  
 GAS TANK SEALER SLOSH . . . . . 27  
 GAS TANK SENDING UNITS . . . . . 97  
 GENERATORS . . . . . 51, 62, 242  
 GIFTS . . . . . 15, 18-21  
 GLASS . . . . . 215-217, 226  
 GLOVE BOX . . . . . 196-197  
 GREASE FITTINGS . . . . . 134, 137  
 GRILLES . . . . . 151-154, 156  
 GROUND STRAPS . . . . . 63

**H**

HEAD GASKET . . . . . 45  
 HEADLIGHTS . . . . . 80-86, 159, 189  
 HEADLINERS . . . . . 182-185  
 HEATER & RELATED . . . . . 54-56  
 HOG RINGS . . . . . 186  
 HOOD & RELATED . . . . . 155-158, 167  
 HORNS & RELATED . . . . . 68-69, 72, 129  
 HOSE-BULK . . . . . 203, 205  
 HOSE CONNECTOR . . . . . 205  
 HUB . . . . . 139-141  
 HUB CAPS . . . . . 140-141

**I**

IFS . . . . . 132  
 IGNITION & RELATED . . . . . 65, 67  
 INSTALLATION MANUALS . . . . . 240-241  
 INSTRUMENT GAUGES & RELATED . . . . . 98, 193-195  
 INSULATION . . . . . 29, 177, 179  
 INTAKE MANIFOLDS . . . . . 41, 94, 102, 105

**K**

KEY BLANKS . . . . . 67, 209  
 KICK PANELS . . . . . 185

NOTE: Any chemicals will be shipped domestic ground only (Lower 48 states only). No international shipping.

KING PINS.....133

**L**

LEAF SPRINGS .....134  
 LED .....80  
 LICENSE .....93, 146, 149-150  
 LICENSE LIGHTS.....93  
 LICENSE PLATES & RELATED.....93, 146, 149-150  
 LIFTERS.....39  
 LINE CLAMPS .....95, 111, 118-119  
 LOWERING BLOCKS .....136  
 LUBRICATOR .....27  
 LUG NUTS .....143

**M**

MAIN BEARINGS.....41  
 MANUALS .....237-241  
 MASTER .....118-119, 122-123, 181  
 MASTER CYLINDERS .....118-119, 122-123, 181  
 METAL PREP .....26, 96  
 MIRRORS .....191-192  
 MOTOR MOUNTS .....47  
 MUFFLERS .....105-106

**O**

OAKIE BUSHINGS.....114  
 OILING COMPONENTS .....25, 38, 42-43, 46, 194  
 OIL TROUGH ALIGNMENT TOOL .....40  
 ORIGINAL CARDS .....242-244  
 OVERFLOW TANKS .....49-50

**P**

PAINTS .....29-31, 54, 107  
 PARK LIGHTS .....73-76  
 PETCOCK.....51  
 PILOT BEARINGS .....109  
 PILOT BUSHINGS .....109  
 PISTONS & RELATED .....36, 40  
 PITMAN ARM.....128  
 PITMAN SHAFT .....129-130  
 PLASTIC BLOCK .....24  
 PLASTIGAUGE .....41  
 POINTS .....66  
 POWER STEERING .....128  
 POWER WINDOWS .....224

PRESSURE .....109  
 PRESSURE PLATES.....109  
 PUSHRODS .....39

**R**

RADIATORS .....48-51, 154  
 RADIOS .....196, 198-201  
 REAR .....115-116, 136-137, 146-147, 149, 186, 216  
 REAR AXLE .....115-116  
 REAR BUMPERS.....146-147, 149  
 REAR CORNER CAB GLASS .....216  
 REAR SPLASH APRON .....149  
 REAR SUSPENSION .....136-137  
 REGULATOR .....223  
 RESISTORS .....55  
 REVERSE POLARITY SWITCH.....59, 66, 72  
 RING & PINION.....115  
 ROCKER ARMS.....38  
 ROD BEARINGS .....40-41  
 ROD DIPPER .....40  
 ROD SERVICE .....40  
 ROLLER BEARING CONVERSION.....144  
 ROLL PANS .....146-147  
 ROTORS.....66  
 RUNNING BOARDS.....162  
 RUST TREATMENT .....26

**S**

SALES BROCHURES .....237, 239  
 SCREWS-INTERIOR.....184-185  
 SEATS .....182, 186  
 SERVICE BULLETINS .....239  
 SETTING TAPE.....219  
 SHACKLES .....133, 137  
 SHEET METAL.....165  
 SHIFTERS .....111-112  
 SHIFT KNOBS.....111, 190  
 SHOCK LINKS.....133, 136  
 SHOCKS-FRONT.....132, 137  
 SHOCKS-REAR .....136-137  
 SOUND DEADENING.....179  
 SOUND-VIBRATION DAMPING .....183  
 SPARE TIRE CARRIER.....236  
 SPARK PLUGS.....66  
 SPARK PLUG WIRES.....66  
 SPEEDOMETERS .....111, 194  
 SPINDLE NUT .....143

SPLASH APRONS .....149  
 SPOTLIGHTS ..... 77-78  
 STARTERS & RELATED ..... 58-59, 181  
 STEEL BED FLOOR .....229  
 STEERING COLUMNS & RELATED ..... 128-129, 188  
 STEERING WHEELS ..... 68-69, 128-129  
 STOVE BOLTS ..... 41  
 SUN SHADE ..... 184  
 SUNVISORS ..... 183-184  
 SWAY BAR BUSHING .....133  
 SWAY BAR-FRONT .....132

**T**

TAGS-ANTIFREEZE .....242  
 TAGS-CIGAR .....242  
 TAGS-DATA .....242  
 TAGS-DELCO REMY ..... 62, 66, 242  
 TAGS-HEATER .....242-243  
 TAGS-OIL FILTER .....243  
 TAILGATES ..... 228-229, 234-236  
 TAIL LIGHTS ..... 88, 90-93  
 TEMPERATURE GAUGE ..... 51, 194  
 TEMPLATES .....240-241  
 TERMINAL BOARDS ..... 72, 83  
 THERMOSTATS ..... 51  
 THROTTLE CABLES & RELATED ..... 101, 189-190  
 THROWOUT ARM & BEARING .....109  
 TIE RODS .....130  
 TIMING COVER ..... 40, 46  
 TIMING COVER GASKETS ..... 46  
 TIMING GEARS ..... 40  
 TIMING HOLE PLUG ..... 41, 67  
 TINNERMAN NUTS .....143  
 TIRES ..... 24, 142-143  
 TISSUE DISPENSERS ..... 191  
 TOE ..... 174  
 TOOLS ..... 27-28  
 TORQUE TUBES .....114  
 TRAFFIC LIGHT VIEWERS .....188  
 TRANSMISSIONS & COMPONENTS ..... 111-113, 206  
 TRUCK BEDS ..... 228-234  
 TRUCK COVERS ..... 24  
 TUBE SHOCK MOUNTS .....132-133  
 TURN SIGNALS ..... 73-75, 189

**U**

U-BOLT .....134

U-JOINTS .....114

**V**

VACUUM ADVANCE LINES .....101  
 VACUUM ADVANCES .....66  
 VACUUM HOSE .....205  
 VALVE COVERS .....37-38, 45  
 VALVE GRIND GASKETS .....45  
 VANITY .....191  
 VEHICLE ACCESSORIES ..... 15-17  
 VENT GLASS .....216  
 VENT WINDOW & RELATED .....222  
 VOLTAGE BOOSTERS ..... 193, 198  
 VOLTAGE CUT OUTS .....62  
 VOLTAGE REDUCERS ..... 95, 193  
 VOLTAGE REGULATORS .....63

**W**

WALL CLOCKS ..... 19-20  
 WALL SIGNS ..... 20, 242  
 WATER .....23, 50-51  
 WATER PUMPS ..... 50-51  
 WHEEL BEARING DUST COVER .....143  
 WHEEL BEARINGS .....143  
 WHEEL CYLINDERS .....123-124  
 WHEELS ..... 68-69, 128-129, 138-140  
 WINDLACE .....213  
 WINDOW CHANNELS .....223  
 WINDOW COMPONENTS .....222-224  
 WINDOW CRANKS .....224-225  
 WINDOW KNOBS .....189  
 WINDOW REGULATORS .....224-225  
 WINDSHIELD COMPONENTS .....218-220  
 WINDSHIELD CRANKS .....188-189  
 WINDSHIELD GLASS .....215-216  
 WINDSHIELD KNOBS .....189  
 WINDSHIELD MOULDINGS .....185  
 WINDSHIELD WASHERS .....205  
 WINDSHIELD WIPERS ..... 188, 202-206, 223  
 WIPER TRANSMISSION .....206  
 WIRE-BULK ..... 72, 78  
 WIRE CONDUIT .....93  
 WIRE HARNESSSES ..... 70-72, 75  
 WIRE LOOMS ..... 65, 72  
 WOODRUFF KEYS ..... 40, 46

# Curing Slow Starting Problems On 1936-1953 6 Volt Vehicles (Cadillacs Used In This Example)

BY JAY FRIEDMAN AND ART GARDNER

**W**e love six-volt Cadillacs and encourage folks to keep 'em six-volt! Unfortunately, slow or hard starting sometimes causes owners to consider converting the car to 12 volts, which usually is unnecessary and sometimes regretted afterwards.

On six-volt cars, the margin for error is much smaller than on 12-volt cars. On a 12-volt car, if the grounds are iffy, it'll probably still crank. If the 12-volt cables are skinnier than specified, it'll probably still start. If the 12-volt starter is tired or the engine is hot, it'll probably still turn over fine. But, on a six-volt car, maybe not.

Starting from only a nominal six volts (or, more technically, 7.2 volts), if the system experiences much of a voltage drop, there just isn't enough voltage potential to make things work well. So, you need a quality six-volt battery, a good charging system, an ignition system that is in tune, and, most of all, you need **proper cables and good grounds**. If you have paid attention to each of these details and still find the starter motor turning the engine slowly, here is one more trick: add a heavy ground strap directly to the starter's commutator endplate. This article explains how to do that.

Most 1936-'48 Cadillacs' battery ground straps extend from the battery to a bolt on the car's frame. Beginning in 1949, the battery's ground strap extends from this grounding point on the frame to one of the bolts holding the starter to the engine. If you read the CLC online Discussion Forum from time to time, you may have come across a series of postings some months ago that discussed an improvement, which consists

of grounding the battery directly to the "commutator endplate" of the starter.

The first time either of the authors saw one of those postings on the Forum, we were quite skeptical about whether this would really help. However, after additional reading, we not only found out all about endplates, but learned how to go about installing a new grounding bolt on a 1949's starter endplate and hooking up a ground strap to it. We did it on two cars, and, as a result, both now start perfectly.

Look at the back of your car's starter; that is, the end that does **not** go in the motor. This back end is the "commutator endplate," or, as it is called in some Cadillac literature, the "end frame." They are the same on all 1936-'52 Cadillac starters. [See photo below.]

▼ **THE ARROW** points to the commutator endplate of this starter.



Inside the starter, the endplate supports the starter's commutator and its brushes. Using a ruler or even a string, roughly determine the approximate distance from the endplate to the nearest point of your car's battery ground strap. As mentioned in a previous paragraph, on a '36-'48 car, this is probably a point on the frame, while on a '49-'52 car, it is one of the starter mounting bolts. File this distance away for the moment.

Remove the starter from the car and put it on a bench. You'll see that there are two bolts that hold the endplate to the rest of the starter. Remove these very long bolts that go right through the starter, pry open the endplate with a thin screwdriver or scraper and pull it off. (In doing so, you may hear a loud snap as the brush springs are released.) Don't let the rest of the starter components come apart, as the two long bolts hold the whole starter together. You'll see four brush assemblies on the inside of the

endplate. The brushes are the parts on the assembly with a screw through them. They fit over the commutator, which is the copper-colored round part that you can see in the main starter housing.

Hold the endplate up to the starter housing in the position it would be if it were still mounted on the starter. You'll see there is a small hole in the starter housing, into which goes a small pin on the inner perimeter of the endplate that positions the endplate on the starter. In this way, you may get a more precise idea as to the place on the outside of the endplate that is closest to the point on the frame or starter to which your current ground strap is bolted.

On a drill press, or, if you don't have one, using a hand drill, from the inside of the endplate, drill a  $\frac{3}{8}$ -inch hole in the endplate about  $\frac{3}{4}$  inch in from its outer perimeter, as near as possible to the place on the endplate you noted in the previous paragraph. Make sure the hole doesn't interfere with a brush assembly. Put a rag or piece of rolled-up paper in the hole in the center of the inside of the endplate that contains the bushing to

prevent any drill chips from going in the hole. Using a file or a "deburring" tool, clean off any burrs caused by the drilling on the perimeter of the drilled hole.

Buy a stainless steel  $\frac{3}{8}$ -inch coarse-threaded ( $\frac{3}{8} \times 16$ ) bolt  $1\frac{1}{4}$  or  $1\frac{1}{2}$  inches long, along with two stainless steel  $\frac{3}{8}$ -inch nuts and two  $\frac{3}{8}$ -inch lock washers. Using one of the nuts and one lock washer, install the bolt on the endplate with the bolt head inside the endplate and the threaded part of the bolt on the outside of the endplate.

Reinstall the endplate on the starter. Holding it at a 45-degree angle against the starter, push one, or, if you can, two of the brush assemblies over the commutator, while at the same time, you bend out the remaining brush assembly springs with a screwdriver so they go over the commutator. This is a bit tricky, so be patient. Make sure the small pin on the inner perimeter of the endplate that positions the endplate on the starter goes into the small hole in the starter housing. Reinstall and tighten the two long bolts. [See photo at right.]

Clean any paint off the other end of the starter where it mates to the motor as well as the adjacent surfaces of the motor. Reinstall the starter back on the motor.

Using the distance you estimated earlier, or, better yet, after measuring it again with the new bolt installed, obtain a ground strap of that length similar to the one in the photo below. It must be long enough to reach from the bolt that holds your battery ground

strap to the car's frame ('36-'48) or the starter ('49-'52) to the new bolt on the endplate. Ground straps like this can be found on eBay, on Amazon or at a local auto parts store. If the holes in the new ground strap are less than  $\frac{3}{8}$  inch in diameter, drill them out to  $\frac{3}{8}$  inch.

Unbolt the current ground strap from the frame or starter bolt, but not from the battery. Clean any paint or dirt off the place on the frame or starter and its bolt that the ground strap touches. Together with the original ground strap, bolt one end of your new ground strap to the same bolt on the frame or starter to which the original current ground strap is bolted. (You now have two ground straps bolted to the same place on the frame or starter.) Put the other end of the new ground strap over the new bolt on the starter endplate and fasten it with the second lock washer and the second nut.

You are now finished. [See photo, next page.] Your engine will turn over



▶ **COMMUTATOR ENDPLATE** with new grounding bolt installed.

▼ **TYPE OF** second ground strap needed, length to be determined.



#### MATERIALS NEEDED

- One 3/8-inch stainless steel coarse-threaded bolt 1 1/4 or 1 1/2 inches long;
- Two 3/8-inch coarse threaded nuts;
- Two 3/8-inch lock washers; and
- One ground strap as per the photo, length to be determined.

#### TOOLS NEEDED OTHER THAN ORDINARY HAND TOOLS

- Drill press or handheld drill; and
- Curved "starter" wrenches for the bolts holding the starter to the motor. [On most cars, the starter wrenches must be 5/8 inch.]

a lot faster and start more easily. By providing a more direct grounding of the starter commutator endplate, more of the battery's electrical potential (voltage) is applied to the starter's brushes, maximizing the effectiveness of the starter. You'll be surprised at how much of a difference this can make—we certainly were! ■

---

*Jay Friedman, winner of the 2010 THE SELF-STARTER Author of the Year award, lives in Decatur, Ga. Art Gardner lives in Marietta, Ga.*



**NEW SECOND GROUND STRAP** on a 1949-'52 starter. [A shorter second strap could have been used.] Arrow points to new grounding bolt. On a 1949-'52 motor, the battery ground strap will be attached to the same bolt at the left as the new second ground strap. On 1936-'48 cars, the second ground strap will be bolted to the grounding bolt on the frame.

**Reprinted With Permission From, "The Self-Starters"**

# Fifty Reasons We Love This '41



**Text By Dan Burrill**

**Photos By Dan Burrill  
&  
Jeff Stites**

Today cars come with many standard features that were rare options 80-years ago. This perfectly restored 1941 Chevrolet Cabriolet, owned by Ron Wade is a classic example. In fact this car is so unusual and so well done that it won the Prestigious National Vintage Chevrolet Club of America's Best of Show. But the really unusual things about this car are the 50 factory offered options or accessories that are on the car.

This is partly due to the fact that Ron Wade is a visionary when it comes to rare and collectable cars. In the early 1970's he put together a list of the 25 most desirable cars that he would like to own, cars that were low production, typically Hi-Performance, convertibles or luxury cars.

Now keep in mind that at that time he didn't own any of these cars and in some cases it would be years before he actually found the cars and started restoring them. However, he knew what he wanted, and he started buying NOS parts and accessories for these cars, while the parts were still available at swap meets and from dealers. So years later, when he actually started restoring these low production collector cars, he already had a stockpile of parts.

One of those cars high up on the wish list was this 1941 Chevrolet Cabriolet. He bought the first '41 in about 1984 and before he got started on it, some folks came

by with a better car that they were going to ship to Australia. But when they discovered the cost to ship a car that far, they opted to trade the car to Ron for a crate of original vintage Chevrolet parts and they shipped that instead, and Ron received a nicer car for his restoration project.

Although Ron had many of the required optional accessories, there were many more that were (are) so rare that it took him years to acquire them and several of the optional accessories are on this car may very well be the only ones in existence.

When talking about this car, the word, "rare," comes up about 100 times in the conversation. In fact, it took Ron years just to find the books, brochures, and parts catalogs that showed pictures of some of the original accessories and then the search was on for the actual items.



Needless to say, this is a frame off restoration that took years to complete. The car was in average condition for a '41, so once the car was completely dismantled everything needed to be cleaned, fixed, repaired, re-welded, reinforced or replaced.

Like all restored vehicles the work is tremendous and very time consuming, not to mention the financial aspect. The Restoration was done by Bill Baker; Paint and body by Keith Grendahl at New Start Autobody; Upholstery by the late Ken Jones; and a great deal of credit goes to Master Technician Ray Holland for his help in finishing the project.

After years of collecting parts, Ron's passion finally developed into a business and for the last 34-years his company, Chev's of the 40's, (Vancouver, WA), has been providing the best in restoration parts for 1937-54 Chevrolet Cars and Trucks. And, of course, the "Fabulous '41," has become the Flagship car for the company.

## Here are the 50 original accessories that make this a very rare car:

### Under The Hood

- Air Filter: The oil bath air filter.
- Valve Cover & Breather: The April 1941 Service Bulletin showed an optional valve cover and breather cap. After some searching, the item was found on a military vehicle in a wrecking yard. Ron speculates these may have been for the military as we were gearing up for WWII.
- The ground strap going from the firewall to the back of the head was only used on cars with 5-band radios.
- The external oil filter was not a standard item and was difficult to find. It was 15-years before Ron could even find what it looked like.
- The windshield washer reservoir bottle with pump on the firewall.
- Radiator overflow return tank.

### Exterior

- Antenna – Reel: Took 20-years of aggressive looking to locate one that could be restored.
- The hand crank and the crank support – front bumper. "These are the only ones we have ever seen."
- Driving Lights.
- The sharks tail exhaust tip is extremely rare.
- Fender skirts: These were very hard to find and even in their "found" condition, they were expensive. The fender skirt moldings are almost impossible to find today.
- Fold down rear guard: The rear guard had to fold down for the spare tire to be removed.
- Foot Scraper: This was the first year that Chevrolets didn't have running boards, and GM was concerned that the farmers wouldn't buy the cars because they didn't have anyplace to wipe their feet (before getting into the car). So the designers at GM made "foot scrapers," an option that received mixed reviews.



### Exterior-Continued

- Gas cap – GM locking.
- Grille guard bumper and Grille winter guard.
- The Initial holder over the rear license plate frame is a great personal touch. Is this the only one in existence? Ron has never heard of another one.
- Passenger side outside mirror.
- Spare tire inflater.
- Back up light.
- Wing tips, bumper.
- License plate frames are adjustable and the '41s are unusual because the outside corners are reversed in that they go over the top of the straight pieces instead of going under.
- Rear axle ratio 3.70:1
- Washboard, front fender.
- Whitewall tires, wheel disks, and beauty rings.





- Windshield washers.
- The Flying Lady Hood Ornament adds a lot of class, and breaks up the wide expanse of the hood and front fenders.



- Outside Thermometer is mounted on the driver's side door so it can be seen from inside the car without rolling down the window. This was a hard item to find and it took a few years for Ron to finally locate this one.

### Interior

- Armrest – center. This center armrest was an unusual item that adds a nice touch to the burgundy front seat.
- Electric clock -An interesting side note; The gold in the electric clock is a different color than the gold in the speedometer even though they were from the same year.
- The Compass is a nice touch and fits well on the center of the windshield.
- Cowl vent knob – ivory.
- Emergency brake whistle.
- Flashlight: this was another hard-to-find item.
- Super Deluxe Heater and Defroster. These are two items that we think of as being part of any modern car, but the defroster and the Super Deluxe Heater were options in 1941. The optional under seat heater couldn't be used with the Cabriolet because there was an X-member added to the frame for additional support.
- Horn, Town and Country.
- Mirror, day/night. This style mirror was only used one year, which made the search just that much more difficult.
- Mirror, lighted vanity for the ladies. The lighted vanity mirror was also a practical item because there are places to write the mileage for the next oil change, check battery, record next lube job, spark plugs, and tune motor.
- Radio – AM and 4 short wave bands. It's been said that at night you could pick up Europe.
- The left and right spot lights with the ivory ball on the handle were only offered for the first half of the model year.

- Radio, pocket portable has become a very expensive item and very hard to find a good one. This also was a 20-year search.

- This Silk Umbrella may very well be the only one that survived. The silk was oiled and over the years the silk is stuck or glued together, so the umbrella is never opened. Still in the NOS box.

- Steering wheel spinner was a neat touch and a handy item to have in the 1940's. Because they cracked easily there are very few around and they require total restoration.

- Tire pump has been restored and the new labels are available. It took years to find out what the original tire pump even looked like. Ron finally found it in a 1937 Chevy parts book.



- This NOS Tool kit is all original and the box has been faithfully reproduced.



- This all purpose combination tool was another rare item.



- Turn signals were another item that took 20-years to find.
- The clip on visor was great for reducing glare.
- Air freshener on visor.



## A Short History of Chevs of the 40's



We're not your average parts house! We didn't buy a building, slap a name on it and say, "We're Chevs of the 40's." Neither were we a planned business venture. When President Ron Wade began restoring his 1941 Chevrolet Special Deluxe Cabriolet, he found himself running in circles searching for the correct restoration parts. If he couldn't find it, he had it made. Many of the parts had to be ordered in such a large volume that he began placing classified ads selling these parts that nobody else offered.



So, where did he store all of these parts and pieces? Under the bed, on the fridge, in the rafters over the garage; virtually any place there was an empty hole in the house. That was over three decades ago. Now Chevs has over 25,000 square feet of shelf space, 20 full-time employees who run the day-to-day operation and the latest in computer technology. We constantly research the much-needed, hard-to-find parts that everyone is looking for and if there's a demand, we consider having them made. What was a rather limited supply of parts three decades ago has turned into well over 800,000 parts in stock from which you can choose.



A lot was learned restoring Ron's Cabriolet. Countless hours have dedicated to having the correct parts made as well as improving the products we sell today. Ron's Cabriolet has over 50 (yes 50) factory accessories that have been collected and restored over the last three decades. The accessories are worth more than the car itself!

1939 = 17 bars; 1940 = 16 bars

The 1941 Cabriolet took home "Best of Class" and "Best of Show" in the VCCA National Convention, held in Springfield, Illinois. It also received "Best of Class" at the Forest Grove Concourse D'Elegance, and was one of three cars on the podium for "Best of Show." (The Best of Show award went to a rare 1931 V16 Cadillac.)

He didn't do it all himself-he had help! The restoration was performed by Bill Baker; the arrow-straight body and paint is courtesy of Keith Grendahl; Ken Jones stitched up the leather upholstery; and master technician Ray Holland provided all of the nitty-gritty details that make this car factory-correct. (And, of course, the able assistance of the Chevs staff.)





**CHEVS OF THE 40'S**  
 1605 NE 112th St.  
 Vancouver, WA 98686  
 800-999-2438

PRSRST STD  
 US POSTAGE  
 PAID  
 CHEVS OF 40'S  
 VANCOUVER, WA

**Mailing address & warehouse**

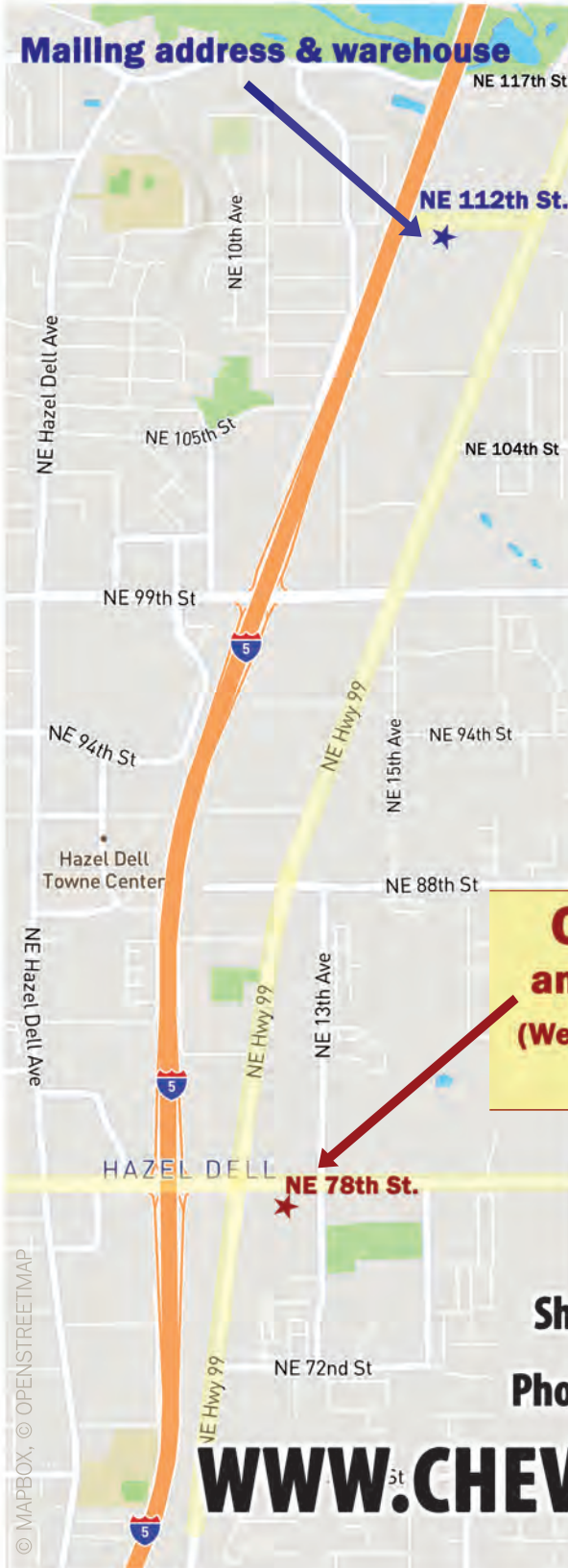

**Chevs of the 40's Showroom  
 and Cars by Ron Wade at WAAAM West  
 (Western Aeroplane and Antique Automobile Museum)  
 1015 NE 78th St. • Vancouver, WA 98665**

**West Coast Hours**

**Showroom: M-F 8 a.m. – 5 p.m.**

**Phone Orders: M-F 6 a.m. – 5 p.m.**

**WWW.CHEVSOFTHE40S.COM**



**Visit us  
 online!**