

# CHEVS OF THE 40'S

*World's most complete supplier of 1937-54 Chevrolet car & truck parts*

## **2024 EDITION CAR CATALOG**

**Order:**

**1-800-999-CHEV (2438)**

**1-360-816-0211**

**Fax: 1-800-888-CHEV (2438)**

**\$4.50**



**1-800-999-CHEV(2438)**

**Shop online: [www.chevsofthe40s.com](http://www.chevsofthe40s.com)**

*To our Valued Customers:*

For over 4 decades we have been providing the best in restoration parts for 1937–54 Chevrolet Cars & Trucks. We continue to expand our inventory of hard-to-find restoration parts while improving our selection of Street Rod Parts. We strive to provide the best in service, quality and variety of parts needed for your vehicle—from a complete restoration to a full-blown street machine. We have an easy to use Illustrated Index in the front of our catalog to make finding parts easy along with an alphabetical Parts Index in the back.

Street Rod parts are found in our STREET ROD HEADQUARTERS catalog and online at [www.STREETRODHQ.com](http://www.STREETRODHQ.com).

*Thanks for your business!*

*Ron Wade  
CEO/Owner*

## HOW TO ORDER

**ONLINE:** Order anytime by accessing our online catalog from our website, [www.chevsofthe40s.com](http://www.chevsofthe40s.com). Credit card information is secure and we don't sell our customer database to anyone.

**Call toll-free:** 1-800-999-CHEV (2438)

Our sales reps are available to assist you:

- via the phone: 6 a.m. – 5 p.m. Pacific Time, Mon. – Fri.
- in the showroom: 8 a.m. – 5 p.m., Mon. – Fri.
- via our lovable voice mail for after-hour and weekend calls.

Existing customers—Simply provide your name and customer number off your catalog label, vehicle year, series and body style, credit card number (if appropriate), part numbers with descriptions and quantities.

New customers—Please provide all of the above information as well as your phone number (in case we have a question about the order) and a complete address including zip code.

---

**Stuff our attorneys want us to say: Chev's of the 40's will not be responsible for any expenses incurred for installation, modification, fitting or shop repairs of parts. The items sold in this catalog are without warranties of any kind. Items and prices in this catalog are subject to change without notice. Information in this catalog may contain typographical errors or inaccuracies. We reserve the right to correct errors or omissions.**

## HOW TO PAY

Use **Check by Phone** to achieve prompt shipping (10 days faster than mailing a check.) And because it helps reduce our costs, our reward to you is a 4% discount on parts when you place your first electronic-check order by phone. Try it—it's convenient and secure.

**Checks** by mail are welcome; however the accounting department may hold your order on uncertified funds. At company discretion, a mailed-in check may be converted to an electronic check.

Checks and money orders need to be in U.S. funds.

*Returned checks will be charged an NSF fee.*

**Credit Cards**—Visa, MasterCard and Discover are welcome! Ship-to address must match your credit card billing address.

## HOW WE SHIP

**How We Ship:** We ship via UPS and USPS Flate Rate Priority Mail (size and weight permitting). For international orders we use UPS Expedited or USPS Priority Mail. Please talk to our sales staff for a shipping quote.

When purchasing oversized parts, some can be shipped via UPS and others need to be sent via truck freight, so please call for rates.

If paying by check, please call for shipping rates and order total.

**Shipping Time** on ground deliveries takes 2 to 14 days depending on your location. For faster service options, when placing an order, please ask your sales person for an express delivery quote.

*Most orders ship the same day!*

**Sales Tax:** Due to the Wayfair decision, we must now charge sales tax to all applicable states. Tax is calculated on the order total (including shipping). Tax rates vary according to your region.

## HOW PROBLEMS ARE HANDLED

**Damage Claims:** If a package appears to be damaged upon delivery, open the package with the delivery driver and have them note any damages. Then call Chev's of the 40s immediately to notify us of any problems/damages. Do not ship to Chev's of the 40s; we will let you know what to do next.

**Shortages:** All orders are scanned with a bar code reader before shipping. If, in the unlikely event a shipment error occurs, call us immediately.

**Back Orders:** Our computerized inventory system allows us to maintain tight control on our stocking levels. However, we do not have control over our suppliers. Back orders are not charged until they ship. Shipment occurs immediately when we receive the part.

## RETURNS/EXCHANGES

Made-to-order items, such as glass, are non-returnable. All other parts (excluding Odds & Ends) may be returned within 30 days. Damaged or altered parts cannot be returned. CODs will not be accepted. Returns subject to a 25% restocking fee.

1. Have your invoice ready.
2. Call 1-800-999-CHEV (2438).
3. Obtain return authorization number.
4. Write the number on the outside of the package and on a copy of the invoice.
5. Include invoice copy in package.

Remember: Shipping can take up to 14 days, so allow 3–4 weeks on returns. Warranty applies only to purchase price of item or replacement of part.

Unfortunately credit card companies no longer credit your credit cards for returns after 90 days. Therefore, we will issue in-store credits or a refund check.

*Note: Product pricing and availability subject to change.*

## PHOTOS

Email us high-resolution photos of your restored and street rod Chevys! We love to see them and might even put them in one of our catalogs or advertisements!



# Table of Contents & Illustrated Index

Click on a section number and jump to that location!



**Business Coupe (3-Pass.)**

- 1937–53
- No back seat
- Gas filler located behind right door (1937–48)



**Coupe (5-Pass.)**

- 1937–54
- With back seat
- Gas filler located in rear right fender (37–48)



**Hardtop**

- No pillar between door and quarter glass
- 1950–52 Backglass uses three pieces
- 1953–54 Backglass uses one piece



**Sedan**

- Pillar between door and quarter glass
- One-piece backglass
- Quarter glass rolls up and down



**Cabriolet/Convertible**

- The term "Cabriolet" was used until 1948
- The term "Convertible" started in 1949



**1942–48 Two-Door Aerosedan/Fleetline**

- Trunk is integrated with roof line "Fastback"
- Fleetline trim on fenders and fender extensions
- Fastback



**Four-Door Sedan**



**Coupe Pick-Up**



**Sedan Delivery**



**Four-Door Station Wagon**

Number ID, Production Numbers, Paint & Trim Charts (Sect. [5C](#), [8C](#))

Art, Collectibles, Tools, Car Care, Car Covers (Sect. [10C](#), [12C](#), [15C](#))

Engine (Sect. [20C](#), [22C](#), [24C](#), [26C](#))

Cooling, Heating (Sect. [30C](#), [35C](#))

Engine Electrical: Starters, Alternators, Distributors, Ignition (Sect. [40C](#), [45C](#), [50C](#), [55C](#))

Electrical (Sect. [60C](#))

Lighting: Turn Signals, Headlights, Tail Lights (Sect. [80C](#), [85C](#), [90C](#), [100C](#), [110C](#))

Fuel & Exhaust (Sect. [120C](#), [130C](#))

Clutch, Transmission, Driveline, Rear End (Sect. [140C](#), [150C](#), [160C](#), [170C](#))

Brakes, Steering (Sect. [180C](#), [190C](#))

Suspension, Wheels, Hubcaps, Bearings (Sect. [200C](#), [210C](#), [220C](#))

Bumpers, Grilles, Hoods (Sect. [230C](#), [240C](#), [250C](#))

Fenders, Running Boards, Sill Plates (Sect. [260C](#), [270C](#), [280C](#), [290C](#))

Body (Sect. [294C](#), [295C](#), [300C](#))

Firewall, Floorboard, Interior (Sect. [310C](#), [320C](#), [330C](#), [335C](#))

Dash, Mirrors, Radio, Wipers (Sect. [340C](#), [345C](#), [350C](#), [360C](#), [370C](#))

Doors (Sect. [380C](#), [390C](#), [400C](#))

Windows: Glass and Rubber (Sect. [420C](#), [430C](#), [440C](#), [450C](#), [452C](#), [455C](#), [460C](#))

Trunk, Convertible (Sect. [490C](#), [510C](#))

Manuals, Tags, Decals, Photos (Sect. [520C](#), [530C](#), [550C](#), [560C](#), [570C](#))

[Parts Index](#)



**1941 Cabriolet—Ron Wade, Owner, Chev's of the 40's**



Ron Wade's National Vintage Chevrolet Club of America's Best of Show 1941 Cabriolet has over 50 accessories: Air filter—oil bath, antenna—reel, armrest—center, back-up light, beauty rings, clock—electric, compass, cowl vent knob—ivory, crank support—front bumper, crank—hand, defroster, driving lights, emergency brake whistle, exhaust tip—sharks tail, fender skirts, flashlight, fold-down rear guard, foot scraper, gas cap—GM locking, GM caroma, grill—winterguard, grill guard—bumper, heater—super deluxe, hood

ornament—flying lady, horn—town & country, initial holder, license frames, mirror—day/night, mirror—lighted vanity, mirror—right, oil filter, passing lights, radiator screen—outside, radiator—overflow tank, radio—AM and 4-band short wave, radio—pocket portable, rear axle 3.70, rear fender guards, spare tire inflator, spotlight—left and right, steering wheel—spinner, thermometer, tire pump, tires—whitewall, tool kit, turn signals, umbrella—silk, valve cover breather, visor—clip-on, washboards—front fender, wheel disks, and windshield washers.



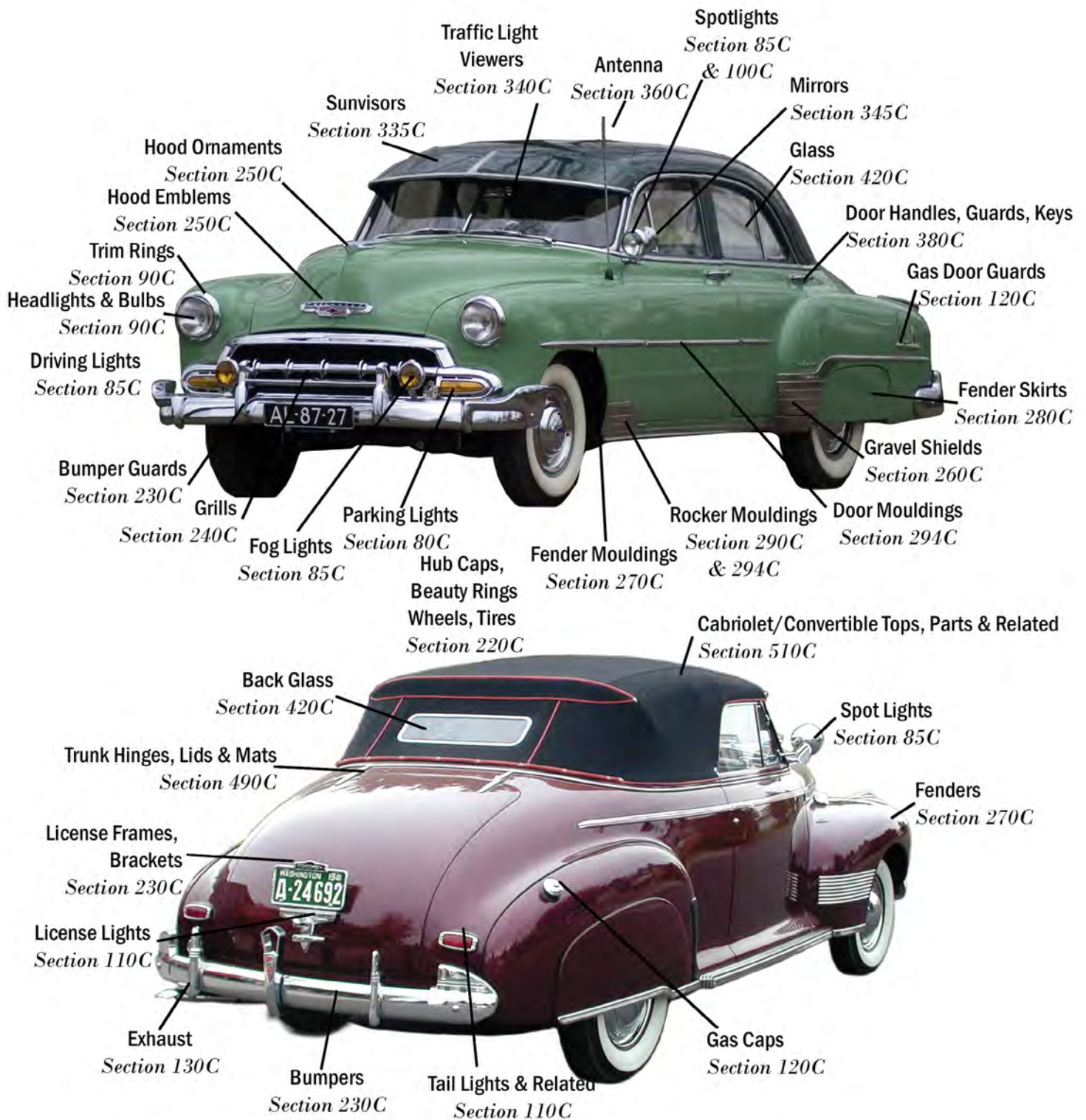

NOTE: Any chemicals will be shipped domestic ground only (Lower 48 states only). No international shipping.

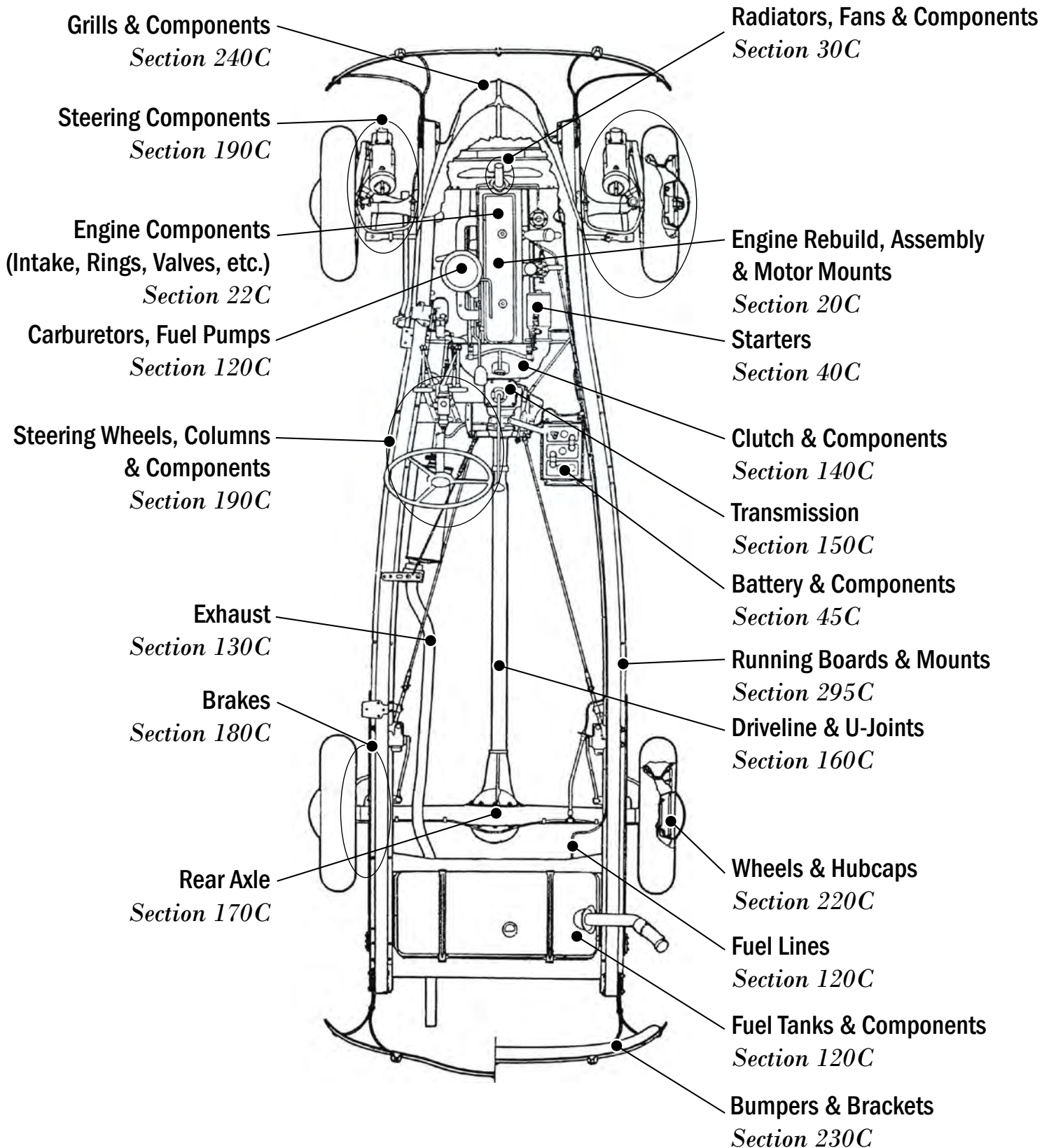



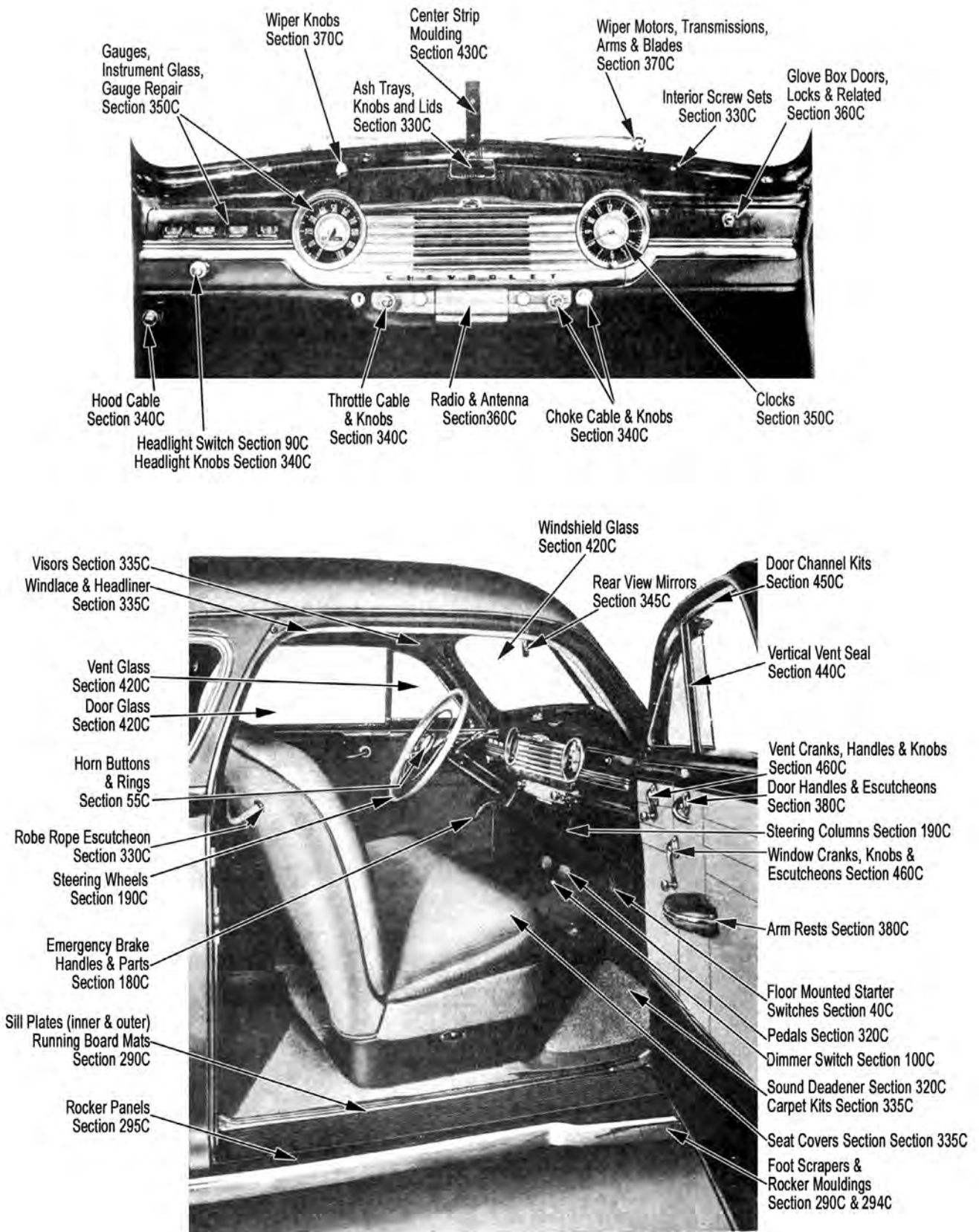

**INSTRUMENT PANEL AND FRONT COMPARTMENT**

NOTE: Any chemicals will be shipped domestic ground only (Lower 48 states only). No international shipping.

**Phone: (360) 816-0211 • (800) 999-CHEV (2438) • www.chevsofthe40s.com**

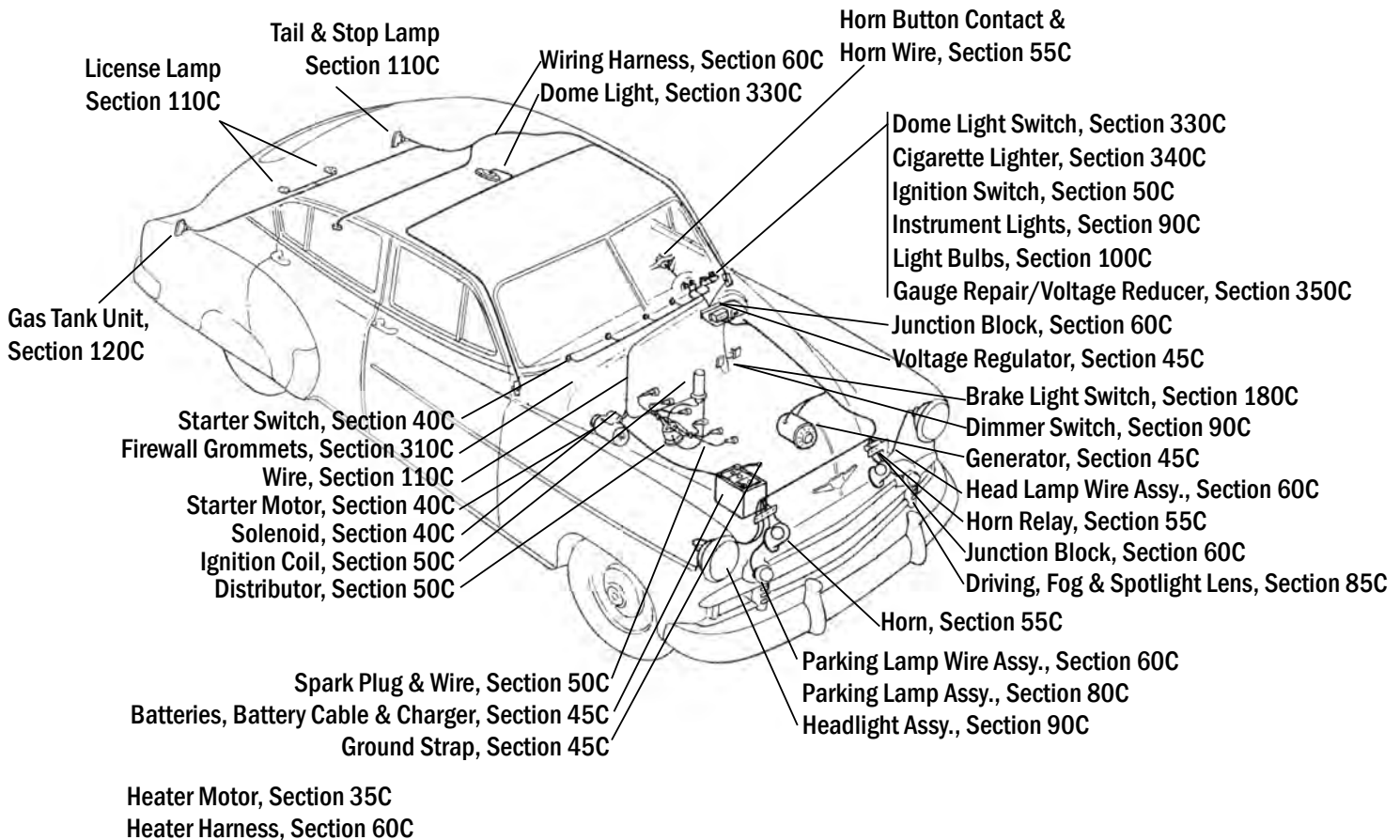
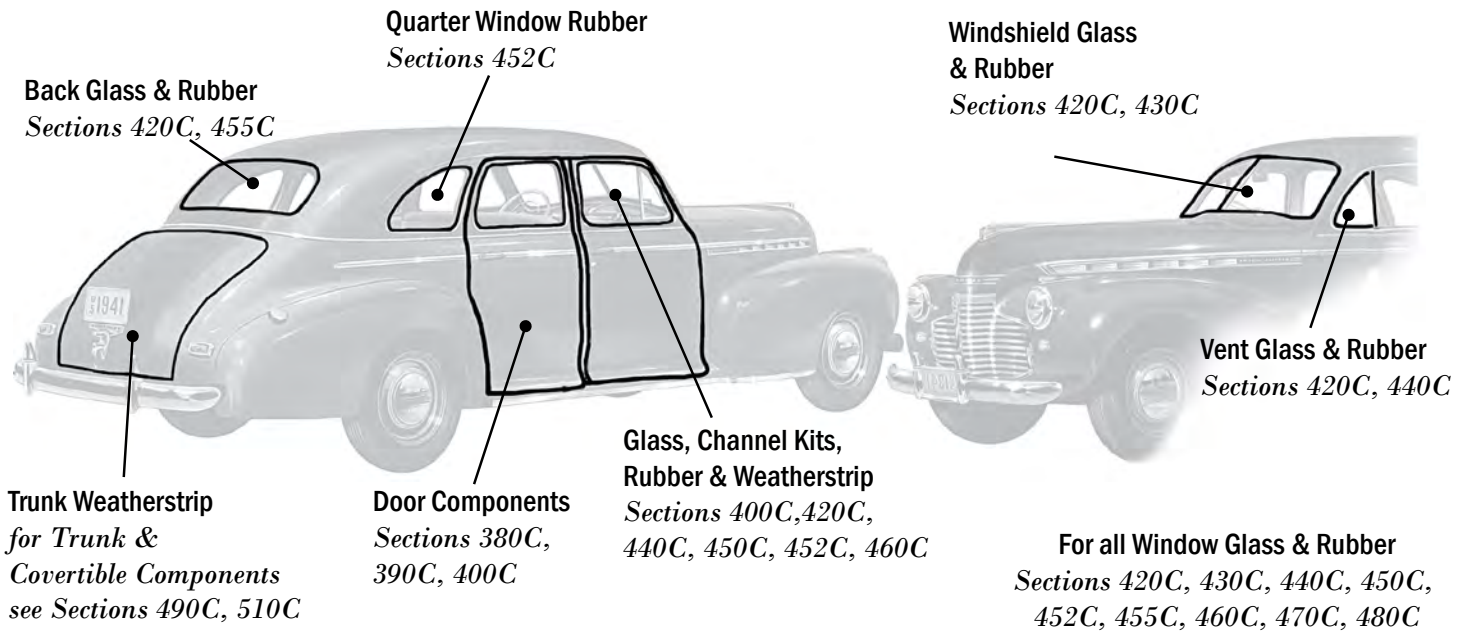



**Sheetmetal, Section 295C**

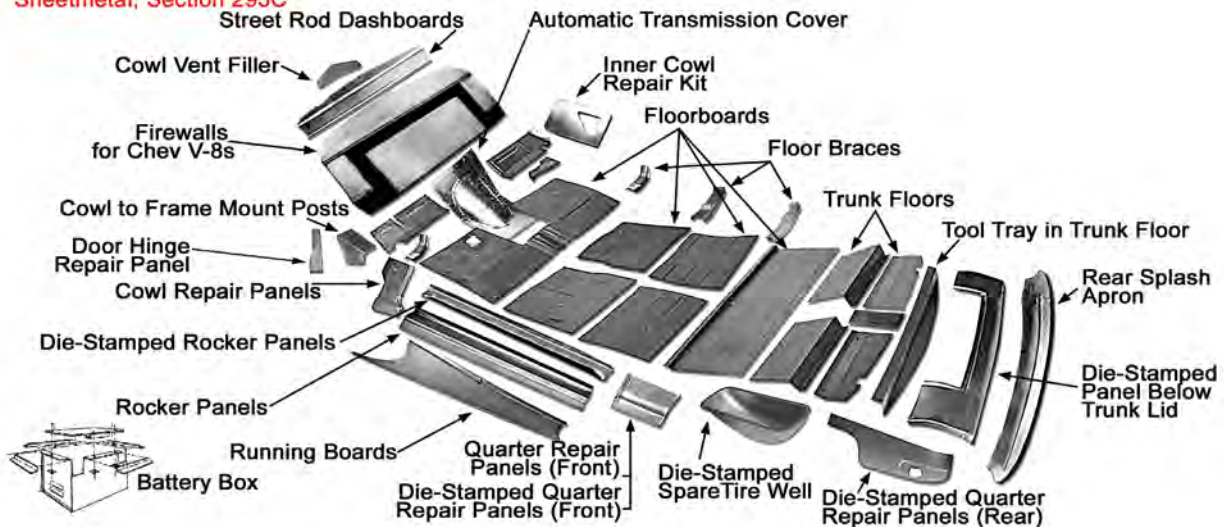

**ILLUSTRATION INDEX BY SECTION**

|  |      |
|--|------|
| Body Mountings . . . . .                   | 294C |
| Brakes . . . . .                           | 180C |
| Chassis . . . . .                          | TOC  |
| Clutch . . . . .                           | 140C |
| Column Shifter . . . . .                   | 150C |
| Convertible . . . . .                      | 510C |
| Crankshaft, Camshaft & Oil Pan . . . . .   | 20C  |
| Dash . . . . .                             | 380C |
| Door, Latches, Parts . . . . .             | 380C |
| Electrical . . . . .                       | TOC  |
| Engine & Engine Mounts . . . . .           | 20C  |
| Exhaust System . . . . .                   | 130C |
| Exterior Body & Glass . . . . .            | TOC  |
| Front Axle . . . . .                       | 210C |
| Front End . . . . .                        | 235C |
| Glass Rubber . . . . .                     | 420C |
| Grille & Front End . . . . .               | 200C |
| Interior . . . . .                         | TOC  |
| Model Serial Identification . . . . .      | 5C   |
| Moulding . . . . .                         | 294C |
| Paint Combination Chart . . . . .          | 8C   |
| Passenger Body Model Numbers . . . . .     | 5C   |
| Propeller Shaft . . . . .                  | 140C |
| Rear End Housing . . . . .                 | 150C |
| Rear Suspension . . . . .                  | 210C |
| Rubber . . . . .                           | 420C |
| Rubber & Weatherstrip . . . . .            | TOC  |
| Sheetmetal . . . . .                       | TOC  |
| Steering Column . . . . .                  | 190C |
| Transmission . . . . .                     | 140C |
| Trim Combination Chart . . . . .           | 8C   |
| Trunk . . . . .                            | 490C |
| Two-Tone Color Combination Chart . . . . . | 8C   |
| Window Channel & Rubber . . . . .          | 440C |
| Wipers . . . . .                           | 370C |

**ABBREVIATIONS**

|                      |                              |
|----------------------|------------------------------|
| ACCY . . . . .       | Accessory                    |
| ACT . . . . .        | Action                       |
| AERO . . . . .       | Fleetline 2-Door             |
| ASSY . . . . .       | Assembly                     |
| BK . . . . .         | Back                         |
| BUS . . . . .        | Business                     |
| CBL . . . . .        | Cabriolet                    |
| COE . . . . .        | Cab over Engine              |
| COL . . . . .        | Collect                      |
| COMM . . . . .       | Commercial                   |
| CONVERT . . . . .    | Convertible                  |
| CPE . . . . .        | Coupe                        |
| CVT . . . . .        | Convertible                  |
| VETT/VETTE . . . . . | Corvette                     |
| DLX . . . . .        | Delux                        |
| DR . . . . .         | Door                         |
| DIA . . . . .        | Diameter                     |
| EXC . . . . .        | Except                       |
| FNDR . . . . .       | Fender                       |
| FLINE . . . . .      | Fleetline                    |
| FRGHT . . . . .      | Freight                      |
| FRNT/FTT . . . . .   | Front                        |
| GR . . . . .         | Gear                         |
| GLS . . . . .        | Glass                        |
| HDTT . . . . .       | Hardtop                      |
| HS . . . . .         | Housing                      |
| INCL . . . . .       | Included                     |
| I.D. . . . .         | Inside Diameter              |
| INST/INSTR . . . . . | Instruction                  |
| L&R . . . . .        | Left & Right                 |
| LH/LT . . . . .      | Left Hand                    |
| MLDG . . . . .       | Moulding                     |
| MSTR . . . . .       | Master                       |
| NORS . . . . .       | New Old Replacement<br>Stock |
| O.D. . . . .         | Outside Diameter             |
| ORIG . . . . .       | Original                     |
| ORN . . . . .        | Ornament                     |

**ABBREVIATIONS, CONTINUED**

|                             |                 |
|-----------------------------|-----------------|
| PASS . . . . .              | Passenger       |
| PNL . . . . .               | Panel           |
| PG/PGLIDE/P-GLIDE . . . . . | Powerglide      |
| PR . . . . .                | Pair            |
| QTR . . . . .               | Quarter         |
| RR . . . . .                | Rear            |
| RH/RT . . . . .             | Right Hand      |
| SS/S-STEEL . . . . .        | Stainless Steel |
| SDL . . . . .               | Sedan Delivery  |
| WGN . . . . .               | Wagon           |
| SUSP . . . . .              | Suspension      |
| TRANS/TRANNY . . . . .      | Transmission    |
| UPR . . . . .               | Upper           |
| WGN . . . . .               | Wagon           |
| W-STRIP . . . . .           | Weatherstrip    |
| W-SHIELD . . . . .          | Windshield      |
| YR . . . . .                | Year            |

**MISCELLANEOUS INFO**

**Core Charge Info:** All core charges are refundable when we receive your rebuildable unit in exchange. Please remove all external parts and brackets.

**Part Number Information:** Group and part numbers are original GM when applicable so you may refer to a Chev parts book for questions.

**Exceptions:** Suffix "A"—Part not originally available by itself. Suffix "B"—Not originally available as an assembly. Other suffixes, not originally available by itself or is a modified part.

**If you have an addition or correction for this catalog, please give us a call. We want to provide the best possible service for you!**

NOTE: Any chemicals will be shipped domestic ground only (Lower 48 states only). No international shipping.

**Phone: (360) 816-0211 • (800) 999-CHEV (2438) • www.chevsofthe40s.com**

## Section 5C: Passenger Body Model Numbers

This list will identify body styles with designated job numbers, to which some parts listings will refer to in this section. The nameplate on the car will furnish the body model numbers, trim combination number, and paint combination number. Refer to Paint Combination Chart for detailed information as to colors and Duco numbers.

| Model#      | # Produced | Body Style           | Model                |
|-------------|------------|----------------------|----------------------|
| <b>1937</b> |            |                      |                      |
| 371000      |            | All .....            | DeLuxe Master Series |
| 371200      |            | All .....            | Master Series        |
| 371067      | 1,724      | Cabriolet .....      | DeLuxe Master Series |
| 371001      | 7,260      | Coach .....          | DeLuxe Master Series |
| 371201      | 15,349     | Coach .....          | Master Series        |
| 371017      | 56,166     | Coupe—5-Window ..... | DeLuxe Master Series |
| 371217      | 54,683     | Coupe—5-Window ..... | Master Series        |
| 371087      | 8,935      | Coupe—Sport .....    | DeLuxe Master Series |
| 371019      | 144,110    | Sedan—Sport .....    | DeLuxe Master Series |
| 371219      | 43,240     | Sedan—Sport .....    | Master Series        |
| 371009      | 2,221      | Sedan—Standard ..... | DeLuxe Master Series |
| 371209      | 2,755      | Sedan—Standard ..... | Master Series        |
| 371011      | 300,332    | Sedan—Town .....     | DeLuxe Master Series |
| 371211      | 178,645    | Sedan—Town .....     | Master Series        |
| 371271      |            | Sedan—Delivery ..... | Master Series        |

|             |         |                      |                      |
|-------------|---------|----------------------|----------------------|
| <b>1938</b> |         |                      |                      |
| 381000      |         | All .....            | DeLuxe Master Series |
| 381200      |         | All .....            | Master Series        |
| 381067      | 2,787   | Cabriolet .....      | DeLuxe Master Series |
| 381001      | 1,038   | Coach .....          | DeLuxe Master Series |
| 381201      | 3,326   | Coach .....          | Master Series        |
| 381017      | 2,790   | Coupe—5-Window ..... | DeLuxe Master Series |
| 381217      | 39,793  | Coupe—5-Window ..... | Master Series        |
| 381087      | 2,790   | Coupe—Sport .....    | DeLuxe Master Series |
| 381019      | 76,323  | Sedan—Sport .....    | DeLuxe Master Series |
| 381219      | 20,952  | Sedan—Sport .....    | Master Series        |
| 381009      | 236     | Sedan—Standard ..... | DeLuxe Master Series |
| 381209      | 522     | Sedan—Standard ..... | Master Series        |
| 381011      | 186,233 | Sedan—Town .....     | DeLuxe Master Series |
| 381211      | 95,050  | Sedan—Town .....     | Master Series        |
| 381271      |         | Sedan—Delivery ..... | Master Series        |

|             |         |                           |                      |
|-------------|---------|---------------------------|----------------------|
| <b>1939</b> |         |                           |                      |
| 391000      |         | All .....                 | DeLuxe Master Series |
| 391200      |         | All .....                 | Master "85" Series   |
| 391001      | 180     | Coach .....               | DeLuxe Master Series |
| 391201      | 1,404   | Coach .....               | Master "85" Series   |
| 391017      | 33,809  | Coupe—5-Window .....      | DeLuxe Master Series |
| 391217      | 41,770  | Coupe—5-Window .....      | Master "85" Series   |
| 391027      | 20,908  | Coupe—w/ Aux. Seats ..... | DeLuxe Master Series |
| 391019      | 110,521 | Sedan—Sport .....         | DeLuxe Master Series |
| 391219      | 22,623  | Sedan—Sport .....         | Master "85" Series   |
| 391009      | 68      | Sedan—Standard .....      | DeLuxe Master Series |
| 391209      | 336     | Sedan—Standard .....      | Master "85" Series   |
| 391011      | 220,181 | Sedan—Town .....          | DeLuxe Master Series |
| 391211      | 124,059 | Sedan—Town .....          | Master "85" Series   |
| 391271      |         | Sedan—Delivery .....      | Master "85" Series   |

| Model#      | # Produced | Body Style               | Model                 |
|-------------|------------|--------------------------|-----------------------|
| <b>1940</b> |            |                          |                       |
| 401000      |            | All .....                | Special DeLuxe Series |
| 401500      |            | All .....                | Master DeLuxe Series  |
| 401200      |            | All .....                | Master "85" Series    |
| 401067      | 11,820     | Cabriolet .....          | Special DeLuxe Series |
| 401017      | 25,537     | Coupe .....              | Special DeLuxe Series |
| 401517      | 28,090     | Coupe .....              | Master DeLuxe Series  |
| 401217      | 25,734     | Coupe .....              | Master "85" Series    |
| 401027      | 46,628     | Coupe—w/ Aux. Seat ..... | Special DeLuxe Series |
| 401527      | 17,234     | Coupe—w/ Aux. Seat ..... | Master DeLuxe Series  |
| 401019      | 138,811    | Sedan—Sport .....        | Special DeLuxe Series |
| 401519      | 40,924     | Sedan—Sport .....        | Master DeLuxe Series  |
| 401219      | 11,468     | Sedan—Sport .....        | Master "85" Series    |
| 401011      | 205,910    | Sedan—Town .....         | Special DeLuxe Series |
| 401511      | 143,125    | Sedan—Town .....         | Master DeLuxe Series  |
| 401211      | 66,431     | Sedan—Town .....         | Master "85" Series    |
| 401571      |            | Sedan—Delivery .....     | Master DeLuxe Series  |
| 401271      |            | Sedan—Delivery .....     | Master "85" Series    |

|             |         |                              |                       |
|-------------|---------|------------------------------|-----------------------|
| <b>1941</b> |         |                              |                       |
| 411000      |         | All .....                    | Special DeLuxe Series |
| 411200      |         | All .....                    | Master DeLuxe Series  |
| 411067      | 15,296  | Cabriolet .....              | Special DeLuxe Series |
| 411027      | 155,889 | Coupe—4-Pass. ....           | Special DeLuxe Series |
| 411227      | 79,124  | Coupe—4-Pass. ....           | Master DeLuxe Series  |
| 411027B     | 17,602  | Coupe—2-Pass. ....           | Special DeLuxe Series |
| 411227B     | 48,763  | Coupe—2-Pass. ....           | Master DeLuxe Series  |
| 411227P     |         | Coupe—2-Pass w/ PU Box ..... | Master DeLuxe Series  |
| 411019      | 148,661 | Sedan—Sport, 4-Door .....    | Special DeLuxe Series |
| 411219      | 59,538  | Sedan—Sport, 4-Door .....    | Master DeLuxe Series  |
| 411069      | 34,162  | Sedan—Fl. Line, 4-Door ..... | Special DeLuxe Series |
| 411011      | 228,458 | Sedan—Town, 2-Door .....     | Special DeLuxe Series |
| 411211      | 219,438 | Sedan—Town, 2-Door .....     | Master DeLuxe Series  |
| 411271      |         | Sedan—Delivery .....         | Master DeLuxe Series  |

|             |        |                              |  |
|-------------|--------|------------------------------|--|
| <b>1942</b> |        |                              |  |
| 421000      |        | All .....                    | Fleetmaster/Fleetline Series(Special Deluxe) |
| 421200      |        | All .....                    | Stylemaster (Master Deluxe)                  |
| 421007      | 61,855 | Aerosedan .....              | Fleetline (Special Deluxe)                   |
| 421069      | 14,530 | Sedan—4-Door .....           | Fleetline (Special Deluxe)                   |
| 421067      | 1,182  | Cabriolet .....              | Fleetmaster (Special Deluxe)                 |
| 421027      | 22,187 | Coupe—4-Pass. ....           | Fleetmaster (Special Deluxe)                 |
| 421227      | 17,442 | Coupe—4-Pass. ....           | Stylemaster (Master Deluxe)                  |
| 421027B     | 1,716  | Coupe—2-Pass. ....           | Fleetmaster (Special Deluxe)                 |
| 421227B     | 8,089  | Coupe—2-Pass. ....           | Stylemaster (Master Deluxe)                  |
| 421227P     |        | Coupe—2-Pass w/ PU Box ..... | Stylemaster (Master Deluxe)                  |
| 421019      | 31,441 | Sedan—Sport, 4-Door .....    | Fleetmaster (Special Deluxe)                 |
| 421219      | 14,093 | Sedan—Sport, 4-Door .....    | Stylemaster (Master Deluxe)                  |

Returns require a return authorization number—Please call first. • Note: Product pricing and availability subject to change.



| Model#                 | # Produced | Body Style         | Model                        |
|------------------------|------------|--------------------|------------------------------|
| <b>1942, continued</b> |            |                    |                              |
| 421011                 | 39,421     | Sedan—Town, 2-Door | Fleetmaster (Special Deluxe) |
| 421211                 | 41,872     | Sedan—Town, 2-Door | Stylemaster (Master Deluxe)  |
| 421271                 |            | Sedan—Delivery     | Stylemaster (Master Deluxe)  |

| Model#      | # Produced | Body Style              | Model                 |
|-------------|------------|-------------------------|-----------------------|
| <b>1946</b> |            |                         |                       |
| 461000      |            | All                     | Fleetmaster/Fleetline |
| 461200      |            | All                     | Stylemaster           |
| 421007      | 57,932     | Aerosedan               | Fleetline             |
| 421069      | 7,501      | Sedan—4-Door            | Fleetline             |
| 461067      | 4,508      | Cabriolet               | Fleetmaster           |
| 461027      | 27,036     | Coupe—4-Pass.           | Fleetmaster           |
| 461227      | 19,243     | Coupe—4-Pass.           | Stylemaster           |
| 461027B     |            | Coupe—2-Pass.           | Fleetmaster           |
| 461227B     | 14,267     | Coupe—2-Pass.           | Stylemaster           |
| 461227P     |            | Coupe—2-Pass. w/ PU Box | Stylemaster           |
| 461019      | 73,746     | Sedan—Sport, 4-Door     | Fleetmaster           |
| 461219      | 75,349     | Sedan—Sport, 4-Door     | Stylemaster           |
| 461011      | 56,538     | Sedan—Town, 2-Door      | Fleetmaster           |
| 461211      | 61,104     | Sedan—Town, 2-Door      | Stylemaster           |
| 461271      |            | Sedan—Delivery          | Stylemaster           |

| Model#      | # Produced | Body Style              | Model                 |
|-------------|------------|-------------------------|-----------------------|
| <b>1947</b> |            |                         |                       |
| 471000      |            | All                     | Fleetmaster/Fleetline |
| 471200      |            | All                     | Stylemaster           |
| 421007      | 159,407    | Aerosedan               | Fleetline             |
| 421069      | 54,531     | Sedan—4-Door            | Fleetline             |
| 471067      | 28,443     | Cabriolet               | Fleetmaster           |
| 471027      | 59,661     | Coupe—6-Pass.           | Fleetmaster           |
| 471027B     |            | Coupe—3-Pass.           | Fleetmaster           |
| 471227      | 34,513     | Coupe—6-Pass.           | Stylemaster           |
| 471227B     | 27,403     | Coupe—3-Pass.           | Stylemaster           |
| 471227P     |            | Coupe—3-Pass. w/ PU Box | Stylemaster           |
| 471019      | 91,440     | Sedan—Sport, 4-Door     | Fleetmaster           |
| 471219      | 42,571     | Sedan—Sport, 4-Door     | Stylemaster           |
| 471011      | 80,128     | Sedan—Town, 2-Door      | Fleetmaster           |
| 471211      | 88,534     | Sedan—Town, 2-Door      | Stylemaster           |
| 471271      |            | Sedan—Delivery          | Stylemaster           |

| Model#      | # Produced | Body Style              | Model                 |
|-------------|------------|-------------------------|-----------------------|
| <b>1948</b> |            |                         |                       |
| 481000      |            | All                     | Fleetmaster/Fleetline |
| 481200      |            | All                     | Stylemaster           |
| 421007      | 211,861    | Aerosedan               | Fleetline             |
| 421069      | 83,760     | Sedan—4-Door            | Fleetline             |
| 481067      | 20,471     | Cabriolet               | Fleetmaster           |
| 481027      | 58,786     | Coupe—6-Pass.           | Fleetmaster           |
| 481027B     |            | Coupe—3-Pass.           | Fleetmaster           |
| 481227      | 34,513     | Coupe—6-Pass.           | Stylemaster           |
| 481227B     | 18,396     | Coupe—3-Pass.           | Stylemaster           |
| 481227P     |            | Coupe—3-Pass. w/ PU Box | Stylemaster           |
| 481019      | 93,142     | Sedan—Sport, 4-Door     | Fleetmaster           |
| 481219      | 48,456     | Sedan—Sport, 4-Door     | Stylemaster           |
| 481011      | 66,208     | Sedan—Town, 2-Door      | Fleetmaster           |
| 481211      |            | Sedan—Town, 2-Door      | Stylemaster           |
| 481271      |            | Sedan—Delivery          | Stylemaster           |

| Model#      | # Produced | Body Style            | Model             |
|-------------|------------|-----------------------|-------------------|
| <b>1949</b> |            |                       |                   |
| 491000      | 2100       | All                   | Fleetline DeLuxe  |
|             |            | All                   | Styleline DeLuxe  |
| 491200      | 1500       | All                   | Fleetline Special |
|             |            | All                   | Styleline Special |
| 491007      | 180,251    | Sedan—2-Door          | Fleetline DeLuxe  |
| 491207      | 36,317     | Sedan—2-Door          | Fleetline Special |
| 491008      | 130,323    | Sedan—4-Door          | Fleetline DeLuxe  |
| 491208      | 58,514     | Sedan—4-Door          | Fleetline Special |
| 491067      | 32,392     | Convertible           | Styleline DeLuxe  |
| 491027      | 78,785     | Coupe—6-Pass.         | Styleline DeLuxe  |
| 491227      | 40,239     | Coupe—6-Pass.         | Styleline Special |
| 491227B     | 20,337     | Coupe—3-Pass.         | Styleline Special |
| 491011      | 147,347    | Sedan—2-Door          | Styleline DeLuxe  |
| 491211      | 69,398     | Sedan—2-Door          | Styleline Special |
| 491069      | 191,357    | Sedan—4-Door          | Styleline DeLuxe  |
| 491269      | 46,334     | Sedan—4-Door          | Styleline Special |
| 491061      | 3,342      | Station Wagon (Wood)  | Styleline DeLuxe  |
| 491062      | 2,664      | Station Wagon (Steel) | Styleline DeLuxe  |
| 491271      | 1508       | Sedan—Delivery        | Styleline Special |

| Model#      | # Produced | Body Style     | Model             |
|-------------|------------|----------------|-------------------|
| <b>1950</b> |            |                |                   |
| 501000      | 2100       | All            | Fleetline DeLuxe  |
|             |            |                | Styleline DeLuxe  |
| 501200      | 1500       | All            | Fleetline Special |
|             |            |                | Styleline Special |
| 501007      | 189,509    | Sedan—2-Door   | Fleetline DeLuxe  |
| 501207      | 43,682     | Sedan—2-Door   | Fleetline Special |
| 501008      | 124,287    | Sedan—4-Door   | Fleetline DeLuxe  |
| 501208      | 23,277     | Sedan—4-Door   | Fleetline Special |
| 501067      | 32,810     | Convertible    | Styleline DeLuxe  |
| 501037      | 76,662     | Bel Air        | Styleline DeLuxe  |
| 501027      | 81,536     | Coupe—6-Pass.  | Styleline DeLuxe  |
| 501227      | 28,328     | Coupe—6-Pass.  | Styleline Special |
| 501227B     | 20,984     | Coupe—3-Pass.  | Styleline Special |
| 501011      | 248,567    | Sedan—2-Door   | Styleline DeLuxe  |
| 501211      | 89,897     | Sedan—2-Door   | Styleline Special |
| 501069      | 316,412    | Sedan—4-Door   | Styleline DeLuxe  |
| 501269      | 55,644     | Sedan—4-Door   | Styleline Special |
| 501062      | 166,995    | Station Wagon  | Styleline DeLuxe  |
| 501271      | 1508       | Sedan—Delivery | Styleline Special |

| Model#      | # Produced | Body Style    | Model             |
|-------------|------------|---------------|-------------------|
| <b>1951</b> |            |               |                   |
| 511000      | 2100       | All           | Fleetline DeLuxe  |
|             |            | All           | Styleline DeLuxe  |
| 511200      | 1500       | All           | Fleetline Special |
|             |            | All           | Styleline Special |
| 511007      | 131,910    | Sedan—2-Door  | Fleetline DeLuxe  |
| 511207      | 6,441      | Sedan—2-Door  | Fleetline Special |
| 511008      | 57,963     | Sedan—4-Door  | Fleetline DeLuxe  |
| 511208      | 3,364      | Sedan—4-Door  | Fleetline Special |
| 511067      | 20,172     | Convertible   | Styleline DeLuxe  |
| 511037      | 103,356    | Bel Air       | Styleline DeLuxe  |
| 511027      | 64,976     | Coupe—6-Pass. | Styleline DeLuxe  |
| 511227      | 18,981     | Coupe—6-Pass. | Styleline Special |
| 511227B     | 17,020     | Coupe—3-Pass. | Styleline Special |
| 511011      | 262,933    | Sedan—2-Door  | Styleline DeLuxe  |
| 511211      | 75,566     | Sedan—2-Door  | Styleline Special |
| 511069      | 380,270    | Sedan—4-Door  | Styleline DeLuxe  |

NOTE: Any chemicals will be shipped domestic ground only (Lower 48 states only). No international shipping.

## Section 5C: Passenger Body Model Numbers

| Model#                 | # Produced | Body Style | Model                                 |
|------------------------|------------|------------|---------------------------------------|
| <b>1951, continued</b> |            |            |                                       |
| 511269                 | 63,718     | 1503       | Sedan—4-Door..... Styleline Special   |
| 511062                 | 23,586     | 2119       | Station Wagon..... Styleline DeLuxe   |
| 511271                 |            | 1508       | Sedan—Delivery..... Styleline Special |

| <b>1952</b> |         |      |                                       |
|-------------|---------|------|---------------------------------------|
| 521000      |         | 2100 | All..... Fleetline DeLuxe             |
|             |         |      | All..... Styleline DeLuxe             |
| 521200      |         | 1500 | All..... Styleline Special            |
| 521007      | 37,164  | 2152 | Sedan—2-Door..... Fleetline DeLuxe    |
| 521067      | 11,975  | 2137 | Convertible..... Styleline DeLuxe     |
| 521037      | 74,634  | 2154 | Bel Air..... Styleline DeLuxe         |
| 521027      | 36,954  | 2124 | Coupe—6-Pass..... Styleline DeLuxe    |
| 521227      | 8,906   | 1524 | Coupe—6-Pass..... Styleline Special   |
| 521227B     | 10,359  | 1504 | Coupe—3-Pass..... Styleline Special   |
| 521011      | 215,417 | 2102 | Sedan—2-Door..... Styleline DeLuxe    |
| 521211      | 54,781  | 1502 | Sedan—2-Door..... Styleline Special   |
| 521069      | 319,736 | 2103 | Sedan—4-Door..... Styleline DeLuxe    |
| 521269      | 35,460  | 1503 | Sedan—4-Door..... Styleline Special   |
| 521062      | 12,756  | 2119 | Station Wagon..... Styleline DeLuxe   |
| 521271      |         | 1508 | Sedan—Delivery..... Styleline Special |

| <b>1953</b> |         |      |  |
|-------------|---------|------|--|
| 531000      |         | 2400 | All..... Bel Air                               |
|             |         | 2100 | ..... Two-Ten                                  |
| 531200      |         | 1500 | All..... One-Fifty                             |
| 531011WD    | 144,401 | 2402 | Sedan—2-Door..... Bel Air                      |
| 531037D     | 99,047  | 2454 | Sport Coupe..... Bel Air                       |
| 531067D     | 24,047  | 2434 | Convertible..... Bel Air                       |
| 531069WD    | 246,284 | 2403 | Sedan—4-Door..... Bel Air                      |
| 531011W     | 247,455 | 2102 | Sedan—2-Door..... Two-Ten                      |
| 531027      | 23,961  | 2124 | Club Coupe..... Two-Ten                        |
| 531037      | 14,045  | 2154 | Sport Coupe..... Two-Ten                       |
| 531062      | 7,988   | 2119 | Station Wagon-8 Pass.“Townsmen”..... Two-Ten   |
| 531062F     | 18,258  | 2109 | Station Wagon-6 Pass.“Handyman”..... Two-Ten   |
| 531067      | 5,617   | 2134 | Convertible..... Two-Ten                       |
| 531069W     | 332,497 | 2103 | Sedan—4-Door..... Two-Ten                      |
| 531211      | 79,416  | 1502 | Sedan—2-Door..... One-Fifty                    |
| 531227      | 6,993   | 1524 | Club Coupe..... One-Fifty                      |
| 531227B     | 13,555  | 1504 | Business Coupe..... One-Fifty                  |
| 531262F     | 22,408  | 1509 | Station Wagon-6 Pass.“Handyman”..... One-Fifty |
| 531269      | 54,207  | 1503 | Sedan—4-Door..... One-Fifty                    |
| 531271      |         | 1508 | Sedan—Delivery..... One-Fifty                  |

| <b>1954</b> |         |      |  |
|-------------|---------|------|--|
| 541000      |         | 2400 | All..... Bel Air                             |
|             |         | 2100 | ..... Two-Ten                                |
| 541200      |         | 1500 | All..... One-Fifty                           |
| 541011WD    | 143,573 | 2402 | Sedan—2-Door..... Bel Air                    |
| 541037D     | 66,378  | 2454 | Sport Coupe..... Bel Air                     |
| 541067D     | 19,383  | 2434 | Convertible..... Bel Air                     |
| 541069WD    | 248,750 | 2403 | Sedan—4-Door..... Bel Air                    |
| 541062D     | 8,156   | 2419 | Station Wagon-8 Pass.“Townsmen”..... Bel Air |
| 541011W     | 194,498 | 2102 | Sedan—2-Door..... Two-Ten                    |
| 541011WA    | 66,403  | 2124 | Club Coupe..... Two-Ten                      |
| 541062F     | 27,175  | 2109 | Station Wagon-6 Pass.“Handyman”..... Two-Ten |
| 541069W     | 235,146 | 2103 | Sedan—4-Door..... Two-Ten                    |
| 541211W     | 64,855  | 1502 | Sedan—2-Door..... One-Fifty                  |
| 541211WB    | 10,770  | 1512 | Utility sedan..... One-Fifty                 |

| Model#                 | # Produced | Body Style | Model  |
|------------------------|------------|------------|--|
| <b>1954, continued</b> |            |            |  |
| 541262F                | 21,404     | 1509       | Station Wagon-6 Pass.“Handyman”..... One-Fifty |
| 541269W                | 32,430     | 1503       | Sedan—4-Door..... One-Fifty                    |
| 541271                 |            | 1508       | Sedan—Delivery..... One-Fifty                  |

## Car Model Serial Identification

| Year      | Series | Wheelbase | Type of Vehicle  |
|-----------|--------|-----------|--|
| 1937      | GA     | 112¼      | Passenger (Master DeLuxe) with Knee Action (Enclosed Type)                       |
| 1937      | GB     | 112¼      | Passenger and Sedan Delivery (Master)  |
| 1937      | HA     | 112¼      | Passenger (Master DeLuxe) with Knee Action (Enclosed Type)                       |
| 1938      | HB     | 112¼      | Passenger and Sedan Delivery (Master)  |
| 1939      | JA     | 112¼      | Passenger (Master DeLuxe) with Knee Action (Open Spring Type)                    |
| 1939      | JB     | 112¼      | Passenger and Sedan Delivery (Master “85”)                                       |
| 1940      | KH     | 113       | Passenger (Master DeLuxe) with Knee Action (Open Spring Type)                    |
| 1940      | KA     | 113       | Passenger (Special DeLuxe) with Knee Action (Open Spring Type)                   |
| 1940      | KB     | 113       | Passenger and Sedan Delivery (Master “85”) Conventional Front Axle               |
| 1941      | AH     | 116       | Passenger (Special DeLuxe) with Knee Action (Open Spring Type)                   |
| 1941      | AG     | 116       | Passenger and Sedan Delivery (Master DeLuxe) with Knee Action (Open Spring Type) |
| 1942      | BH     | 116       | Passenger (Special DeLuxe)   |
| 1942      | BG     | 116       | Passenger and Sedan Delivery (Master DeLuxe)                                     |
| 1946      | DK     | 116       | Passenger (Fleetmaster and Fleetline)  |
| 1946      | DJ     | 116       | Passenger (Stylemaster)  |
| 1947      | EK     | 116       | Passenger (Fleetmaster and Fleetline)  |
| 1947      | EJ     | 116       | Passenger (Stylemaster)  |
| 1948      | FK     | 116       | Passenger (Fleetmaster and Fleetline)  |
| 1948      | FJ     | 116       | Passenger (Stylemaster)  |
| 1949      | GK     | 2100 115  | Passenger (DeLuxe) (Styleline and Fleetline)                                     |
| 1949      | GJ     | 1500 115  | Passenger (Special) (Styleline and Fleetline)                                    |
| 1950      | HK     | 2100 115  | Passenger (DeLuxe) (Styleline and Fleetline)                                     |
| 1950      | HJ     | 1500 115  | Passenger (Special) (Styleline and Fleetline)                                    |
| 1951      | JK     | 2100 115  | Passenger (DeLuxe) (Styleline and Fleetline)                                     |
| 1951      | JJ     | 1500 115  | Passenger (Special) (Styleline and Fleetline)                                    |
| 1952      | KK     | 2100 115  | Passenger (DeLuxe) (Styleline and Fleetline)                                     |
| 1953–1955 | A      | 1500 115  | Passenger (One-Fifty) (exec. 1508)   |
| 1953–1955 | B      | 2100 115  | Passenger (Two-Ten)  |
| 1953–1955 | C      | 2400 115  | Passenger (Bel Air)  |
| 1953–1955 | D      | 1508 115  | Sedan Delivery   |
| 1953–1955 | E      | 2934 102  | Corvette   |

Returns require a return authorization number—Please call first. • Note: Product pricing and availability subject to change.



# Section 8C: Paint Combination & Trim Charts

An index of paint combination colors as shown on body name plates, identifying the corresponding DuPont numbers of particular colors included therein. Charts are provided for your convenience only. We do not carry this paint in stock.

| Comb. No.   | Model Usage | BODY                |           | BODY BELT     |           | STRIPING           |           | WHEELS            |       |
|-------------|-------------|---------------------|-----------|---------------|-----------|--------------------|-----------|-------------------|-------|
|             |             | Color               | Ducox No. | Color         | Ducox No. | Color              | Ducox No. | Color             | Dulux |
| <b>1937</b> |             |                     |           |               |           |                    |           |                   |       |
| 207         |             | Swifts Comm. Red    | Dulux 255 |               |           | Silver             | 2894202   | Black             | 231   |
| 208         |             | Export Blue         | Dulux 314 |               |           | Silver             | 2894202   | Black             | 231   |
| 209         |             | Brewster Green Med. | Dulux 267 |               |           | Gigolo Green       | 2899862   | Black             | 231   |
| 210         |             | Black               | 2422101   |               |           | Tokio Ivory        | 2895757   | Black             | 231   |
| 211         |             | Regent Maroon       | 24250721  |               |           | Gold Bronze        | SM1530AA  | Medea Maroon      | 294   |
| 212         |             | Regatta Red         | 2426957   |               |           | Silver             | 2894202   | Regatta Red       | 316   |
| 213         |             | Danube Dusk         | 2426886   |               |           | Cellini Green      | 2893253   | Danube Dusk       | 333   |
| 214         |             | Gunmetal            | 20251632  |               |           | Tokio Ivory        | 2895757   | Gunmetal          | 331   |
| 215         |             | Gazell Brown        | 20251769  |               |           | Fire Red           | 2895327   | Gazell Brown      | 332   |
| 216         |             | Beryl Green         | 20251777  |               |           | Silver             | 2894202   | Beryl Green       | 329   |
| 217         |             | Toronto Blue        | 24250986  |               |           | Silver             | 2894202   | Toronto Blue      | 330   |
| 218         |             | Swan Grey           | 24251103  | Carteret Red  | 24250852  | None               |           | Swan Grey         | 327   |
| 219         |             | Brookhaven Blue     | 20251567  |               |           | Silver             | 2894202   | Brookhaven Blue   | 334   |
| <b>1938</b> |             |                     |           |               |           |                    |           |                   |       |
| 220         |             | Swift Comm. Red     | Dulux 255 |               |           | Argent Silver      | 2894202   | Black             | 231   |
| 221         |             | Export Blue         | Dulux 314 |               |           | Argent Silver      | 2894202   | Black             | 231   |
| 222         |             | Brewster Green      | Dulux 267 |               |           | Gigolo Green       | 2899862   | Black             | 231   |
| 223         |             | Regency Blue        | 20252788  |               |           | Argent Silver      | 2894202   | Regency Blue      | 341   |
| 224         |             | Yorkshire Maroon    | 2426789   |               |           | Vermilion Light    | 2896777   | Yorkshire Maroon  | 336   |
| 225         |             | Terrace Green       | 2421454   |               |           | Dryad Green        | 28951023  | Terrace Green     | 335   |
| 226         |             | Spruce Green        | 20252234  |               |           | Nankeen Green      | 2895265   | spruce Green      | 339   |
| 227         |             | Storm Gray          | 20252578  |               |           | Vermilion Light    | 2896777   | Storm Grey        | 340   |
| 228         |             | Brookwood Beige     | 20251942  |               |           | Kildare Green      | 28950701  | Brookwood Beige   | 338   |
| 229         |             | Woodleaf Brown      | 20251635  |               |           | Nankeen Green      | 2425265   | Woodleaf Brown    | 337   |
| 230         |             | Gunmetal            | 20251632  |               |           | Vermilion Light    | 2896777   | Gunmetal          | 351   |
| 231         |             | Mayland Black       | 2422122   |               |           | Vermilion Light    | 2896777   | Mayland Black     | 353   |
| 232         |             | Indian Suntan       | 20232188  | Nankeen Cream | 2425265   | Rust "C"           | 28952396  | Indian Suntan     | 342   |
| 233         |             | Indian Suntan       | 20232188  |               |           | Nankeen Green      | 2895265   | Indian Suntan     | 342   |
| 234         |             | Silver Grey Green   | 20252194  |               |           | Sir W. Ral. Orange | 2897843   | Silver Grey Green | 350   |
| 235         |             | Regency Blue        | 20253109  |               |           | Silver             | 2894202   | Regency Blue      | 341   |
| 236         |             | Venetian Maroon     | 24232342  |               |           | Vermilion Light    | 2896777   | Venetian Maroon   | 355   |
| 237         |             | Kashan Green        | 24250686  |               |           | Primrose Yellow    | 2895009   | Kashan Green      | 357   |
| 238         |             | Alpine Green        | 2425988   |               |           | Primrose Yellow    | 2895009   | Alpine Green      | 388   |
| 239         |             | Interlaken Blue     | 20252533  |               |           | White              | 289008    | Interlaken Blue   | 359   |
| 240         |             | Mayland Black       | 2422122   |               |           | Nankeen Cream      | 2895265   | Mayland Black     | 353   |
| 241         |             | Pennant Blue        | 20251567  |               |           | White              | 289008    | Pennant Blue      | 334   |
| <b>1939</b> |             |                     |           |               |           |                    |           |                   |       |
| 242         |             | Swifts Comm. Red    | Dulux 255 |               |           | Argent Silver      | 2894202   | Black             | 231   |
| 243         |             | Export Blue         | Dulux 314 |               |           | Argent Silver      | 2894202   | Black             | 231   |
| 244         |             | Brewster Green      | Dulux 267 |               |           | Gigolo Green       | 2899862   | Black             | 231   |
| 245         |             | Mars Grey           | 20232549  |               |           | Cabbage Grey       | 28951093  | Mars Grey         | 371   |
| 246         |             | Ridge Green         | 20253334  |               |           | Chantilly Green    | 28951095  | Ridge Green       | 372   |
| 247         |             | Wood Ash Brown      | 20253254  |               |           | Beige Casino       | 28951737  | Wood Ash Brown    | 373   |
| 248         |             | Cloisonne Maroon    | 24233001  |               |           | Argent Silver      | 2894202   | Cloisonne Maroon  | 374   |
| 249         |             | Sun Beige           | 20252375  |               |           | Vermilion Light    | 2896777   | Sun Beige         | 375   |
| 250         |             | Regency Blue        | 20253109  |               |           | Argent Silver      | 2894202   | Regency Blue      | 341   |
| 251         |             | Mayland Black       | 2462048   |               |           | Nankeen Cream      | 2895265   | Mayland Black     | 353   |
| 252         |             | Mayland Black       | 2462048   |               |           | Vermilion Light    | 2896777   | Mayland Black     | 353   |
| 253         |             | Four Leaf Green     | 20232505  |               |           | None               |           | Aqualon Yellow    | 376   |
| 254         |             | Wood Ash Brown      | 20253254  |               |           | Beige Casino       | 28951737  | Wood Ash Brown    | 373   |
| 255         |             | Four Leaf Green     | 20232505  |               |           | Aqualon Yellow     | 28952985  | Four Leaf Green   | 378   |
| 256         |             | Tusk Ivory          | 24251737  |               |           | Vermilion Light    | 2896777   | Tusk Ivory        | 382   |
| 257         |             | Yosemite Green      | 20232503  |               |           | Tipperary Green    | 28952425  | Yosemite Green    | 384   |
| 258         |             | Granville Grey      | 20252875  |               |           | White              | 289-1     | Granville Grey    | 383   |

NOTE: Any chemicals will be shipped domestic ground only (Lower 48 states only). No international shipping.

## Section 8C: Paint Combination & Trim Charts

|                        |             | BODY                 |           | BODY BELT  |          | STRIPING        |          | WHEELS               |       |
|------------------------|-------------|----------------------|-----------|------------|----------|-----------------|----------|----------------------|-------|
| Comb. No.              | Model Usage | Color                | Duco No.  | Color      | Duco No. | Color           | Duco No. | Color                | Dulux |
| <b>1939, continued</b> |             |                      |           |            |          |                 |          |                      |       |
| 259                    |             | Shoreahm Beige       | 20253097  |            |          | Trianon Beige   | 28950527 | Shoreahm Beige       | 385   |
| 260                    |             | Granville Grey       | 20252875  |            |          | Vermilon Light  | 2896777  | Granville Grey       | 383   |
| 261                    |             | Italian Cream        | 24252881  |            |          | Black           | 4072122  | Italian Cream        | 391   |
| <b>1940</b>            |             |                      |           |            |          |                 |          |                      |       |
| 262                    |             | Swift Comm. Red      | Dulux 255 | Black      | 2072122  | Argent Silver   | 2894202  | Black                | 386   |
| 263                    |             | Export Blue          | Dulux 314 | Silver     | 2894202  | Totem Scarlet   | 28950165 | Black                | 386   |
| 264                    |             | Brewster Green Med.  | Dulux 267 | Cream Med. | 2896596  | Emerald Green   | 2893133  | Black                | 386   |
| 265                    |             | Ridge Green Metallic | 21353334  |            |          | Chantilly Green | 28951095 | Ridge Green Metallic | 372   |
| 266                    |             | Harbor Blue          | 21332536  |            |          | Blazon Blue     | 28950854 | Harbor Blue          | 403   |
| 267                    |             | Streamline Grey      | 21332554  |            |          | Sun Fish Orange | 2896277  | Streamline Grey      | 406   |
|                        |             |                      |           |            |          | Gold Bronze     | SM1530AA |                      |       |
|                        |             |                      |           |            |          | Tokio Ivory     | 2895757  |                      |       |
| 270                    |             | Arden Beige          | 21353042  |            |          | Tusk Ivory      | 28951737 | Arden Beige          | 409   |
| 271                    |             | Battleship Grey      | 21332541  |            |          | Vermilon Light  | 2896777  | Battleship Grey      | 407   |
| 272                    |             | Gulf Blue            | 21332523  |            |          | Gold Bronze     | SM1530AA | Gulf Blue            | 404   |
| 273                    |             | Mayland Black        | 2532122   |            |          | Vermilon Light  | 2896777  | Black                | 386   |
| 274                    |             | Mayland Black        | 2532122   |            |          | Tokio Ivory     | 2895757  | Black                | 386   |
| 275                    |             | Kingston Grey        | 25353332  |            |          | Biarritz Red    | 28953276 | Biarritz Red         | 411   |
| 276                    |             | Maple Brown          | 21353255  |            |          | Tokio Ivory     | 2895757  | Maple Brown          | 408   |
| 277                    |             | Traverse Green       | 21336141  |            |          | Tokio Ivory     | 2895757  | Traverse Green       | 405   |
| 278                    |             | Ruby Maroon          | 21333042  |            |          | Gold Bronze     | SM1530AA | Ruby Maroon          | 402   |
| 279                    |             | Kingston Grey        | 25353332  |            |          | Biarritz Red    | 28953276 | Kingston Grey        | 412   |
| 280                    |             | California Beige     | 25337053  |            |          | Biarritz Red    | 28953276 | California Beige     | 414   |
| 281                    |             | Alameda Green        | 21332508  |            |          | Tokio Ivory     | 2895757  | Alameda Green        | 413   |
| 282                    |             | Beach Ivory          | 24252881  |            |          | Black           | 2072122  | Italian Cream        | 391   |
| <b>1941</b>            |             |                      |           |            |          |                 |          |                      |       |
| 288                    |             | Ridge Green          | 21353334  |            |          | Chantilly Green | 28951095 | Ridge Green          | 372   |
| 289                    |             | Banner Beige         | 21336043  |            |          | Shawnee Red     | 2895905  | Banner Beige         | 455   |
| 290                    |             | Ruby Maroon          | 21333042  |            |          | Gold Bronze     | SM1530AA | Ruby Maroon          | 402   |
| 291                    |             | Kingston Grey        | 25353332  |            |          | Shawnee Red     | 2895905  | Kingston Grey        | 412   |
| 292                    |             | Cruiser Grey         | 21332552  |            |          | Shawnee Red     | 2895905  | Cruiser Grey         | 456   |
| 293                    |             | Squadron Grey        | 21336329  |            |          | Shawnee Red     | 2895905  | Squadron Grey        | 457   |
| 294                    |             | Constitution Blue    | 21336487  |            |          | Argent Silver   |          | Constitution Blue    | 458   |
| 295                    |             | Marine Blue          | 21332527  |            |          | Gold Bronze     | SM1530AA | Marine Blue          | 459   |
| 296                    |             | Admiral Green        | 21332515  |            |          | Chantilly Green | 28951095 | Admiral Green        | 460   |
| 297                    |             | Mayland Black        | 2532122   |            |          | Tokio Ivory     | 2895757  | Black                | 286   |
| 298                    |             | Cameo Cream          | 25337871  |            |          | Black           | 2072122  | Cameo Cream          | 461   |
| <b>1942</b>            |             |                      |           |            |          |                 |          |                      |       |
| 308                    |             | Mayland Black        | 2532122   |            |          | Tokio Ivory     | 2895757  | Black                | 386   |
| 309                    |             | Martial Maroon       | 21333039  |            |          | Gold Bronze     | SM1530AA | Martial Maroon       | 402   |
| 310                    |             | Seafoam Green        | 25354118  |            |          | White           | 289-1    | Seafoam Green        | 475   |
| 311                    |             | Volunteer Green      | 21352195  |            |          | Chantilly Green | 28951095 | Volunteer Green      | 476   |
| 312                    |             | Sport Beige          | 25351737  |            |          | Scout Brown     | 28950964 | Sport Beige          | 382   |
| 313                    |             | Santone Beige        | 21353261  |            |          | Tokio Ivory     | 2895757  | Santone Beige        | 472   |
| 314                    |             | Torpedo Grey         | 25353332  |            |          | Shawnee Red     | 2895905  | Torpedo Grey         | 412   |
| 315                    |             | Chevron Grey         | 21353476  |            |          | Shawnee Red     | 2895905  | Chevron Grey         | 473   |
| 316                    |             | Ensign Blue          | 21336863  |            |          | Gold Bronze     | SM1530AA | Ensign Blue          | 474   |
| 317                    |             | Maple Brown          | 21353255  |            |          | Tokio Ivory     | 2895757  | Maple Brown          | 408   |
| 318                    |             | Martial Maroon       | 21333039  |            |          | Gold Bronze     | SM1530AA | Martial Maroon       | 402   |
| <b>1946</b>            |             |                      |           |            |          |                 |          |                      |       |
| 336                    |             | Mayland Black        | 2532122   |            |          | Tokio Ivory     | 2895757  | Black                | 386   |
| 337                    |             | Martial Maroon       | 21333039  |            |          | Gold Bronze     | SM1530AA | Martial Maroon       | 402   |
| 338                    |             | Ensign Blue          | 21336863  |            |          | Gold Bronze     | SM1530AA | Ensign Blue          | 474   |

Returns require a return authorization number—Please call first. • Note: Product pricing and availability subject to change.



| Comb. No.   | Model Usage | BODY              |          | BODY BELT |          | STRIPING      |          | WHEELS               |       |
|-------------|-------------|-------------------|----------|-----------|----------|---------------|----------|----------------------|-------|
|             |             | Color             | Duco No. | Color     | Duco No. | Color         | Duco No. | Color                | Dulux |
| <b>1947</b> |             |                   |          |           |          |               |          |                      |       |
| 344         |             | Mayland Black     | 2532144  |           |          | Argent Silver | 2894202  | Black                | 505   |
| 345         |             | Oxford Maroon     | 20739638 |           |          | Argent Silver | 2894202  | Oxford Maroon Met.   | 512   |
| 346         |             | Lullwater Green   | 20739406 |           |          | Argent Silver | 2894202  | Lullwater Green Met. | 513   |
| 347         |             | Battleship Grey   | 20754791 |           |          | Argent Silver | 2894202  | Battleship Grey Met. | 514   |
| 348         |             | Sport Beige       | 25351737 |           |          | Scout Brown   | 28950964 | Sport Beige          | 382   |
| 349         |             | Freedom Blue      | 25350633 |           |          | Argent Silver | 2894202  | Freedom Blue         | 515   |
| <b>1948</b> |             |                   |          |           |          |               |          |                      |       |
| 370         |             | Liveoak Green     | 20736777 |           |          | Argent Silver | 2894202  | Liveoak Green        | 538   |
| 371         |             | Lake Como Blue    | 20754041 |           |          | Argent Silver | 2894202  | Lake Como Blue       | 539   |
| 372         |             | Dove Grey         | 20739112 |           |          | French White  | 28953561 | Dove Grey            | 540   |
| 373         |             | Silver Grey Green | 20755015 |           |          | French White  | 28953561 | Silver Grey Green    | 541   |
| 374         |             | Battleship Grey   | 20754791 |           |          | Argent Silver | 2894202  | Battleship Grey      | 514   |
| 375         |             | Oxford Maroon     | 20739638 |           |          | Argent Silver | 2894202  | Oxford Maroon        | 512   |
| 376         |             | Mayland Black     | 2532122  |           |          | Argent Silver | 2894202  | Black                | 505   |
| 381         |             | Satin Green       | 25339814 |           |          | French White  | 28953561 | Satin Green          | 453   |
| 384         |             | Sport Beige       | 25351737 |           |          | Swift Red     | 28954741 | Sport Beige          | 382   |
| <b>1949</b> |             |                   |          |           |          |               |          |                      |       |
| 385         |             | Mayland Black     | 2532122  |           |          | Argent Silver | 2894202  | Black                | 505   |
| 386         |             | Oxford Maroon     | 20739638 |           |          | Argent Silver | 2894202  | Oxford Maroon        | 512   |
| 387         |             | Monaco Blue       | 20739277 |           |          | Argent Silver | 2894202  | Monaco Blue          | 553   |
| 388         |             | Grecian Grey      | 2537869  |           |          | Mayland Black | 2532122  | Grecian Grey         | 551   |
| 389         |             | Vista Grey        | 20736307 |           |          | Argent Silver | 2894202  | Vista Grey           | 550   |
| 390         |             | Liveoak Green     | 20736777 |           |          | Argent Silver | 2894202  | Liveoak Green        | 538   |
| 391         |             | Satin Green       | 25339814 |           |          | French White  | 28953561 | Satin Green          | 543   |
| 392         |             | Ice Green         | 28755255 |           |          | Argent Silver | 2894202  | Ice Green            | 554   |
| 395         |             | Texas Ivory       | 25352626 |           |          | Mayland Black | 2532122  | Texas Ivory          | 552   |
| <b>1950</b> |             |                   |          |           |          |               |          |                      |       |
| 423         |             | Mayland Black     | 2532122  |           |          | Argent Silver | 2894202  | Black                | 505   |
| 424         |             | Oxford Maroon     | 20739638 |           |          | Argent Silver | 2894202  | Oxford maroon        | 512   |
| 425         |             | Grecian Grey      | 2537869  |           |          | Mayland Black | 2532122  | Grecian Grey         | 551   |
| 426         |             | Crystal Green     | 28755255 |           |          | Argent Silver | 2894202  | Crystal Green        | 554   |
| 427         |             | Falcon Grey       | 28155501 |           |          | Argent Silver | 2894202  | Falcon Grey          | 563   |
| 428         |             | Windsor Blue      | 28655498 |           |          | French White  | 28953561 | Windsor Blue         | 564   |
| 429         |             | Mist Green        | 25355504 |           |          | Mayland Black | 2532122  | Mist Green           | 565   |
| 430         |             | Rodeo Beige       | 28155505 |           |          | French White  | 28953561 | Rodeo Beige          | 566   |
| 431         |             | Moonlite Cream    | 25339829 |           |          | Mayland Black | 2532122  | Moonlite Cream       | 562   |
| 437         |             | Grecian Grey      | 2537869  |           |          | Argent Silver | 2894202  | Empire Red           | 567   |
| <b>1951</b> |             |                   |          |           |          |               |          |                      |       |
| 442         |             | Mayland Black     | 2532122  |           |          | Argent Silver | 2894202  | Black                | 505   |
| 443         |             | Burgandy Red      | 28285638 |           |          | Argent Silver | 2894202  | Burgandy Red         | 580   |
| 444         |             | Thistle Grey      | 25370397 |           |          | Mayland Black | 2532122  | Thistle Grey         | 579   |
| 445         |             | Fathom Green      | 28655685 |           |          | Argent Silver | 2894202  | Fathom Green         | 577   |
| 446         |             | Shadow Grey       | 28655659 |           |          | Argent Silver | 2894202  | Shadow Grey          | 578   |
| 447         |             | Trophy Blue       | 28155656 |           |          | Argent Silver | 2894202  | Trophy Blue          | 575   |
| 448         |             | Aspen Green       | 28155657 |           |          | Mayland Black | 2532122  | Aspen Green          | 576   |
| 449         |             | Aztec Tan         | 25355647 |           |          | French White  | 28953561 | Aztec Tan            | 574   |
| 450         |             | Moonlight Cream   | 25339829 |           |          | Mayland Black | 2532122  | Moonlight Cream      | 562   |
| <b>1952</b> |             |                   |          |           |          |               |          |                      |       |
| 465         |             | Onyx Black        | 2532247  |           |          | Argent Silver | 2894202  | Black                | 505   |
| 466         |             | Birch Grey        | 25355987 |           |          | Onyx Black    | 2532247  | Birch Grey           | 600   |
| 467         |             | Dusk Grey         | 28655988 |           |          | Argent Silver | 2894202  | Dusk Grey            | 608   |
| 469         |             | Spring Green      | 25355989 |           |          | Onyx Black    | 2532247  | Spring Green         | 602   |
| 470         |             | Emerald Green     | 28655976 |           |          | Argent Silver | 2894202  | Emerald Green        | 601   |
| 472         |             | Admiral Blue      | 28655991 |           |          | Argent Silver | 2894202  | Admiral Blue         | 609   |

NOTE: Any chemicals will be shipped domestic ground only (Lower 48 states only). No international shipping.

## Section 8C: Paint Combination & Trim Charts

|                        |                            | BODY            |          | BODY BELT |          | STRIPING      |          | WHEELS          |       |
|------------------------|----------------------------|-----------------|----------|-----------|----------|---------------|----------|-----------------|-------|
| Comb. No.              | Model Usage                | Color           | Duco No. | Color     | Duco No. | Color         | Duco No. | Color           | Dulux |
| <b>1952, continued</b> |                            |                 |          |           |          |               |          |                 |       |
| 477                    |                            | Twilight Blue   | 25355992 |           |          | Onyx Black    | 2532247  | Twilight Blue   | 604   |
| 478                    |                            | Sahara Beige    | 25355979 |           |          | Onyx Black    | 2532247  | Sahara Beige    | 603   |
| 479                    |                            | Regal Maroon    | 20755986 |           |          | Argent Silver | 2894202  | Regal Maroon    | 599   |
| 481                    |                            | Cherry          | 25355994 |           |          | Argent Silver | 2894202  | Cherry          | 606   |
| 482                    |                            | Honeydew        | 25355993 |           |          | Onyx Black    | 2532247  | Honeydew        | 605   |
| 483                    |                            | Saddle Brown    | 28655978 |           |          | Argent Silver | 2894202  | Saddle Brown    | 607   |
| <b>1953</b>            |                            |                 |          |           |          |               |          |                 |       |
| 480                    | 1011W-27-37-67-69W         | Onyx Black      | 2532247  |           |          | Argent Silver | 2894202  | Black           | 505   |
| 480                    | 1211-27-27B-69-71          | Onyx Black      | 2532247  |           |          | Argent Silver | 2894202  | Black           | 505   |
| 480                    | Bel Air                    | Onyx Black      | 2532247  |           |          | None          |          | Driftwood Grey  | 623   |
| 490                    | 1011W-27-67-69W            | Driftwood Grey  | 25357335 |           |          | Onyx Black    | 2532247  | Driftwood Grey  | 623   |
| 490                    | 1211-27-27B-69-71          | Driftwood Grey  | 25357335 |           |          | Onyx Black    | 2532247  | Driftwood Grey  | 623   |
| 490                    | 1011WD-67D-69WD            | Driftwood Grey  | 25357335 |           |          | None          |          | Driftwood Grey  | 623   |
| 496                    | 1011W-27-69W               | Dusk Grey       | 28655988 |           |          | Argent Silver | 2894202  | Dusk Grey       | 608   |
| 496                    | 1211-27-27B-69-71          | Dusk Grey       | 28655988 |           |          | Argent Silver | 2894202  | Dusk Grey       | 608   |
| 496                    | 1011WD-69WD                | Dusk Grey       | 28655988 |           |          | None          |          | Driftwood Grey  | 623   |
| 498                    | 1200                       | Surf Green      | 25357332 |           |          | Onyx Black    | 2532247  | Surf Green      | 620   |
| 498                    | 1000 (exc. Bel Air)        | Surf Green      | 25357332 |           |          | Onyx Black    | 2532247  | Surf Green      | 620   |
| 498                    | Bel Air                    | Surf Green      | 25357332 |           |          | None          |          | Campus Cream    | 624   |
| 499                    | 1011W-27-62-62F-69W        | Woodland Green  | 28657333 |           |          | Argent Silver | 2894202  | Woodland Green  | 621   |
| 499                    | 1200 Series                | Woodland Green  | 28657333 |           |          | Argent Silver | 2894202  | Woodland Green  | 621   |
| 499                    | 1011WD-69WD                | Woodland Green  | 28657333 |           |          | None          |          | Campus Cream    | 624   |
| 501                    | 1011W-27-69W               | Regatta Blue    | 28657497 |           |          | Argent Silver | 2894202  | Regatta Blue    | 639   |
| 501                    | 1211-27-27B-69-71          | Regatta Blue    | 28657497 |           |          | Argent Silver | 2894202  | Regatta Blue    | 639   |
| 501                    | 1011WD-69WD                | Regatta Blue    | 28657497 |           |          | None          |          | Driftwood Grey  | 623   |
| 503                    | 1011W-27-37-67-69W         | Horizon Blue    | 25357331 |           |          | Onyx Black    | 2532247  | Horizon Blue    | 619   |
| 503                    | 1211-27-27B-69             | Horizon Blue    | 25357331 |           |          | Onyx Black    | 2532247  | Horizon Blue    | 619   |
| 503                    | Bel Air                    | Horizon Blue    | 25357331 |           |          | None          |          | Driftwood Grey  | 623   |
| 504                    | 1011W-27-62-62F-69W        | Sahara Beige    | 25355979 |           |          | Onyx Black    | 2532247  | Sahara Beige    | 603   |
| 504                    | 1200 Series                | Sahara Beige    | 25355979 |           |          | Onyx Black    | 2532247  | Sahara Beige    | 603   |
| 504                    | 1011WD-69WD                | Sahara Beige    | 25355979 |           |          | None          |          | Sahara Beige    | 603   |
| 505                    | 1011W-27-69W               | Madeira Maroon  | 28157334 |           |          | Argent Silver | 2894202  | Madeira Maroon  | 622   |
| 505                    | 1211-27-27B-69-71          | Madeira Maroon  | 28157334 |           |          | Argent Silver | 2894202  | Madeira Maroon  | 622   |
| 505                    | 1011WD-69WD                | Madeira Maroon  | 28157334 |           |          | None          |          | Sahara Beige    | 603   |
| 506                    | 1067                       | Target Red      | 25357344 |           |          | Argent Silver | 2894202  | Target Red      | 626   |
| 506                    | 1067D                      | Target Red      | 25357344 |           |          | None          |          | Driftwood Grey  | 623   |
| 507                    | 1067                       | Campus Cream    | 25357211 |           |          | Onyx Black    | 2532247  | Campus Cream    | 624   |
| 507                    | 1067D                      | Campus Cream    | 25357211 |           |          | None          |          | Campus Cream    | 624   |
| 508                    | 1067D                      | Sungold         | 25357336 |           |          | None          |          | Driftwood Grey  | 623   |
| 509                    | 1000 (exc. Bel Air)        | Saddle Brown    | 28655978 |           |          | Argent Silver | 2894202  | Saddle Brown    | 607   |
| 509                    | 1211-27-27B-62F-69         | Saddle Brown    | 28655978 |           |          | Argent Silver | 2894202  | Saddle Brown    | 607   |
| 509                    | Bel Air                    | Saddle Brown    | 28655978 |           |          | None          |          | Sahara Beige    | 603   |
| <b>1954</b>            |                            |                 |          |           |          |               |          |                 |       |
| 540                    | 1011W-11WA-69W-1211-69W-71 | Onyx Black      | 2532247  |           |          | Argent Silver | 2894202  | Onyx Black      | 505   |
| 540                    | 1011WD-37D-67D-69WD        | Onyx Black      | 2532247  |           |          | None          |          | Onyx Black      | 505   |
| 541                    | 1011W-11WA-69W-1211-69W-71 | Surf Green      | 25357332 |           |          | Onyx Black    | 2532247  | Surf Green      | 620   |
| 541                    | 1011WD-69WD                | Surf Green      | 25357332 |           |          | None          |          | Surf Green      | 620   |
| 542                    | 1011W-11WA-62F-69W         | Bermuda Green   | 28157601 |           |          | Argent Silver | 2894202  | Bermuda Green   | 645   |
| 542                    | 1211-69W-71                | Bermuda Green   |          |           |          | Argent Silver | 2894202  | Bermuda Green   | 645   |
| 542                    | Bel Air                    | Bermuda Green   |          |           |          | None          |          | Bermuda Green   | 645   |
| 543                    | 10112-11WA-69W-1211-69W-71 | Horizon Blue    | 25357331 |           |          | Onyx Black    | 2532247  | Horizon Blue    | 619   |
| 543                    | 10112D-37D-67D-69WD        | Horizon Blue    |          |           |          | None          |          | Horizon Blue    | 619   |
| 544                    | 1011W-11WA-69W-1211-69W-71 | Biscayne Blue   | 28157600 |           |          | Argent Silver | 2894202  | Biscayne Blue   | 646   |
| 544                    | 1011WD-69WD                | Biscayne Blue   |          |           |          | None          |          | Biscayne Blue   | 646   |
| 545                    | 1011W-62F-69W-1211-62F-69W | Shoreline Beige | 25357602 |           |          | Onyx Black    |          | Shoreline Beige | 647   |
| 545                    | 1011WD-62D-69WD            | Shoreline Beige |          |           |          | None          |          | Shoreline Beige | 647   |
| 546                    | 1011W-62F-69W-1211-69W     | Saddle Brown    | 28655978 |           |          | Argent Silver | 2894202  | Saddle Brown    | 607   |

Returns require a return authorization number—Please call first. • Note: Product pricing and availability subject to change.



|                        |                            | BODY         | BODY BELT |       | STRIPING |               | WHEELS   |              |       |
|------------------------|----------------------------|--------------|-----------|-------|----------|---------------|----------|--------------|-------|
| Comb. No.              | Model Usage                | Color        | Duco No.  | Color | Duco No. | Color         | Duco No. | Color        | Dulux |
| <b>1954, continued</b> |                            |              |           |       |          |               |          |              |       |
| 546                    | 1011WD-37D-67D-69WD        | Saddle Brown |           |       |          | None          |          | Saddle Brown | 607   |
| 547                    | 1011W-11WA-69W-1211-69W-71 | India Ivory  | 25357337  |       |          | Onyx Black    | 2532247  | India Ivory  | 628   |
| 547                    | 1011WD-37D-67D-69WD        | India Ivory  |           |       |          | None          |          | India Ivory  | 628   |
| 548                    | 1011W-69W-1211-69W-71      | Shadow Grey  | 28657631  |       |          | Argent Silver | 2894202  | Shadow Grey  | 654   |
| 548                    | 1011WD-69WD                | Shadow Grey  |           |       |          | None          |          | Shadow Grey  | 654   |
| 549                    | 1011W-69W-1211-62F-69W     | Morocco Red  | 25357750  |       |          | Argent Silver | 2894202  | Morocco Red  | 658   |
| 549                    | 1011WD-69WD                | Morocco Red  |           |       |          | None          |          | Morocco Red  | 658   |
| 550                    | SDL                        | Romany Red   | 25354741  |       |          | Argent Silver | 2894202  | Romany Red   | 506   |
| 550                    | Conv.                      | Romany Red   |           |       |          | None          |          | Romany Red   | 506   |
| 551                    | Conv.                      | Fiesta Cream | 25357604  |       |          | None          |          | Fiesta Cream | 650   |
| 552                    | Conv.                      | Turquoise    | 25357605  |       |          | None          |          | Turquoise    | 651   |
| 553                    | Conv.                      | Pueblo Tan   | 25357606  |       |          | None          |          | Pueblo Tan   | 652   |

## Two-Tone Color Combinations Chart

|             |             | UPPER BODY         | LOWER BODY |                 | WHEEL STRIPING |                 | WHEELS   |                      |       |
|-------------|-------------|--------------------|------------|-----------------|----------------|-----------------|----------|----------------------|-------|
| Comb. No.   | Model Usage | Color              | Duco No.   | Color           | Duco No.       | Color           | Duco No. | Color                | Dulux |
| <b>1940</b> |             |                    |            |                 |                |                 |          |                      |       |
| None        |             | Harbor Blue        | 21332536   | Kingston Grey   | 25353332       | Blazon Blue     | 28950854 | Harbor Blue          | 403   |
| None        |             | Traverse Green     | 21336141   | Kingston Grey   | 25353332       | Tokio Ivory     | 2895757  | Traverse Green       | 405   |
| None        |             | Battleship Grey    | 21332541   | Kingston Grey   | 25353332       | Vermilion Light | 2896777  | Battleship Grey      | 407   |
| None        |             | Ridge Green        | 21353334   | Traverse Green  | 21336141       | Chantilly Green | 28951095 | Ridge Green          | 372   |
| None        |             | Mayland Black      | 2532122    | Glamour Grey    | 21336381       | Nankeen Cream   | 2895265  | Mayland Black        | 353   |
| None        |             | Ruby Maroon        | 21333042   | Arden Beige     | 21353042       | Gold Bronze     | SM1530AA | Ruby Maroon          | 402   |
| None        |             | Kingston Grey      | 25353332   | Battleship Grey | 21332541       | Biarritz Red    | 28953276 | Kingston Grey        | 412   |
| <b>1941</b> |             |                    |            |                 |                |                 |          |                      |       |
| 301         |             | Indian Suntan      | 21332188   | Santone         | 21353261       | Tokio Ivory     | 2895757  | Indian Suntan        | 342   |
| 302         |             | Squadron Grey      | 21336329   | Nassak Grey     | 2536518        | Shawnee Red     | 2895905  | Squadron Grey        | 457   |
| 303         |             | Ridge Green        | 21353334   | Cimmaron Green  | 21336112       | Chantilly Green | 28951095 | Ridge Green          | 372   |
| 304         |             | Marine Blue        | 21332527   | Squadron Grey   | 21336329       | Gold Bronze     | SM1530AA | Marine Blue          | 459   |
| <b>1942</b> |             |                    |            |                 |                |                 |          |                      |       |
| 319         |             | Volunteer Green    | 21352195   | Seafoam Green   | 25354118       | Chantilly Green | 28951095 | Volunteer Green      | 476   |
| 320         |             | Sport Beige        | 25351737   | Scout Brown     | 25350964       | Scout Brown     | 28950964 | Sport Beige          | 382   |
| 321         |             | Torpedo Grey       | 25353332   | Fortress Grey   | 25334411       | Shawnee Red     | 2895905  | Torpedo Grey         | 412   |
| 322         |             | Fleet Blue         | 21336566   | Wing Blue       | 25354123       | White           | 289-1    | Fleet Blue           | 477   |
| <b>1946</b> |             |                    |            |                 |                |                 |          |                      |       |
| 339         |             | Seafoam Green      | 25354118   | Volunteer Green | 21352195       | White           | 289-1    | Seafoam Green        | 475   |
| 340         |             | Sport Beige        | 25351737   | Scout Brown     | 25350964       | Scout Brown     | 28950964 | Sport Beige          | 382   |
| 341         |             | Wing Blue          | 25354123   | Fleet Blue      | 21336566       | White           | 289-1    | Wing Blue            | 443   |
| <b>1947</b> |             |                    |            |                 |                |                 |          |                      |       |
| 350         |             | Sport Beige        | 25351737   | Lullwater Green | 20739406       | Argent Silver   | 2894202  | Lullwater Green Met. | 513   |
| 351         |             | Lakeside Green     | 20736865   | Lullwater Green | 20739406       | Argent Silver   | 2894202  | Lullwater Green Met. | 513   |
| 352         |             | Ozone Blue         | 20752418   | Freedom Blue    | 25350633       | Argent Silver   | 2894202  | Freedom Blue         | 515   |
| 353         |             | Sport Beige        | 25351737   | Scout Brown     | 25350964       | Argent Silver   | 2894202  | Scout Brown          | 440   |
| 354         |             | Oxford Maroon Met. | 20739638   | (Station Wagon) |                | Argent Silver   | 2894202  | Oxford Maroon Met.   | 512   |
| 355         |             | Maple Brown Met.   | 21353255   | (Station Wagon) |                | Tokio Ivory     | 2895757  | Maple Brown Met.     | 408   |
| <b>1948</b> |             |                    |            |                 |                |                 |          |                      |       |
| 377         |             | Satin Green        | 25339414   | Marsh Brown     | 20755021       | Argent Silver   | 2894202  | Marsh Brown          | 542   |
| 378         |             | Silver Grey Green  | 20755015   | Liveoak Green   | 20736777       | Argent Silver   | 2894202  | Liveoak Green        | 538   |
| 379         |             | Dove Grey          | 20739112   | Battleship Grey | 20754791       | Argent Silver   | 2894202  | Battleship Grey      | 514   |
| 380         |             | Dove Grey          | 20739112   | Lake Como Blue  | 20754041       | Argent Silver   | 2894202  | Lake Como Blue       | 539   |
| 393         |             | Satin Green        | 25339814   | Liveoak Green   | 20736777       | Argent Silver   | 2894202  | Liveoak Green        | 538   |

NOTE: Any chemicals will be shipped domestic ground only (Lower 48 states only). No international shipping.

## Section 8C: Paint Combination & Trim Charts

|             |                        | UPPER BODY      |          | LOWER BODY      |          | WHEEL STRIPING |          | WHEELS          |       |
|-------------|------------------------|-----------------|----------|-----------------|----------|----------------|----------|-----------------|-------|
| Comb. No.   | Model Usage            | Color           | Duco No. | Color           | Duco No. | Color          | Duco No. | Color           | Dulux |
| <b>1949</b> |                        |                 |          |                 |          |                |          |                 |       |
| 394         |                        | Grecian Grey    | 2537869  | Vista Grey      | 20736307 | Argent Silver  | 2894202  | Vista Grey      | 550   |
| 396         |                        | Liveoak Green   | 20736777 | (Station Wagon) |          | Argent Silver  | 2894202  | Liveoak Green   | 538   |
| 397         |                        | Oxford Maroon   | 20739638 | (Station Wagon) |          | Argent Silver  | 2894202  | Oxford Maroon   | 512   |
| <b>1950</b> |                        |                 |          |                 |          |                |          |                 |       |
| 432         |                        | Grecian Grey    | 2537869  | Falcon Grey     | 28155501 | Mayland Black  | 2532122  | Grecian Grey    | 551   |
| 433         |                        | Mist Green      | 25355504 | Crystal Green   | 28755255 | Mayland Black  | 2532122  | Mist Green      | 565   |
| 434         |                        | Mist Green      | 25355504 | Mayland Black   | 2532133  | Mayland Black  | 2532122  | Mist Green      | 565   |
| 435         |                        | Windsor Blue    | 28655498 | Grecian Grey    | 2537869  | French White   | 28953561 | Windsor Blue    | 564   |
| 436         |                        | Moonlite Cream  | 28339829 | Falcon Grey     | 28155501 | Mayland Black  | 2532122  | Moonlite Cream  | 562   |
| 438         |                        | Grecian Grey    | 2537869  | Empire Red      | 25339896 | Argent Silver  | 2894202  | Empire Red      | 567   |
| 439         |                        | Oxford Maroon   | 20739638 | (Station Wagon) |          | Argent Silver  | 2894202  | Oxford Maroon   | 512   |
| 440         |                        | Rodeo Beige     | 28155505 | (Station Wagon) |          | French White   | 28953561 | Rodeo Beige     | 566   |
| 441         |                        | Crystal Green   | 28755255 | (Station Wagon) |          | Argent Silver  | 2894202  | Crystal Green   | 554   |
| <b>1951</b> |                        |                 |          |                 |          |                |          |                 |       |
| 451         |                        | Thistle Grey    | 2537869  | Shadow Grey     | 28655659 | Mayland Black  | 2532122  | Thistle Grey    | 579   |
| 452         |                        | Aspen Green     | 28155657 | Fathom Green    | 28655658 | Mayland Black  | 2532122  | Aspen Green     | 576   |
| 453         |                        | Moonlight Cream | 25339829 | Mayland Black   | 2532122  | Mayland Black  | 2532122  | Moonlight Cream | 562   |
| 454         |                        | Trophy Blue     | 28155656 | Thistle Grey    | 25370397 | Argent Silver  | 2894202  | Trophy Blue     | 575   |
| 455         |                        | Shadow Grey     | 28655659 | Thistle Grey    | 25370397 | Argent Silver  | 2894202  | Shadow Grey     | 578   |
| 456         |                        | Fathom Green    | 28655658 | Aspen Green     | 28155657 | Argent Silver  | 2894202  | Fathom Green    | 577   |
| 457         |                        | Aztec Tan       | 25355647 | (Station Wagon) |          | French White   | 28953561 | Aztec Tan       | 574   |
| 458         |                        | Fathom Green    | 28655658 | (Station Wagon) |          | Argent Silver  | 2894202  | Fathom Green    | 577   |
| <b>1952</b> |                        |                 |          |                 |          |                |          |                 |       |
| 468         |                        | Birch Grey      | 25355987 | Dusk Grey       | 28655988 | Onyx Black     | 2532247  | Birch Grey      | 600   |
| 471         |                        | Spring Green    | 25355989 | Emerald Green   | 28655976 | Onyx Black     | 2532247  | Spring Green    | 602   |
| 473         |                        | Twilight Blue   | 25355992 | Admiral Blue    | 28655991 | Onyx Black     | 2532247  | Twilight Blue   | 604   |
| 474         |                        | Emerald Green   | 28655976 | Spring Green    | 25355989 | Argent Silver  | 2894202  | Emerald Green   | 601   |
| 484         |                        | Twilight Blue   | 25355992 | Birch Grey      | 25355987 | Onyx Black     | 2532247  | Twilight Blue   | 604   |
| 485         |                        | Spring Green    | 25355989 | Birch Grey      | 25355987 | Onyx Black     | 2532247  | Spring Green    | 602   |
| 486         |                        | Saddle Brown    | 28655978 | Sahara Beige    | 25355979 | Argent Silver  | 2894202  | Saddle Brown    | 607   |
| 487         |                        | Regal Maroon    | 20755986 | Sahara Beige    | 25355979 | Argent Silver  | 2894202  | Regal Maroon    | 599   |
| 488         |                        | Sahara Beige    | 25355979 | Saddle Brown    | 28655978 | Onyx Black     | 2532247  | Sahara Beige    | 603   |
| 489         |                        | Birch Grey      | 25355987 | Onyx Black      | 2532247  | Onyx Black     | 2532247  | Birch Grey      | 600   |
| 491         |                        | Regal Maroon    | 20755986 | Onyx Black      | 2532247  | Argent Silver  | 2894202  | Regal Maroon    | 599   |
| 492         |                        | Bittersweet     | 25355995 | Beach White     | 25357044 | Bittersweet    | 25355995 | Beach White     | 611   |
| 493         |                        | Honeydew        | 25355993 | Onyx Black      | 2532247  | Onyx Black     | 2532247  | Honeydew        | 605   |
| 494         |                        | Admiral Blue    | 28655991 | Birch Grey      | 25355987 | Argent Silver  | 2894202  | Admiral Blue    | 609   |
| <b>1953</b> |                        |                 |          |                 |          |                |          |                 |       |
| 497         | 1211-27-27B-69,1027    | Dusk Grey       | 28655988 | Driftwood Grey  | 25357335 | Onyx Black     | 2532247  | Driftwood Grey  | 623   |
| 500         | 1011W-27-37-62-62F-69W | Woodland Green  | 28657333 | Surf Green      | 25357332 | Onyx Black     | 2532247  | Surf Green      | 620   |
| 500         | 1211-27-27B-62F-69     | Woodland Green  | 28657333 | Surf Green      | 25357332 | Onyx Black     | 2532247  | Surf Green      | 620   |
| 500         | 1011WD-37D-69WD        | Woodland Green  | 28657333 | Surf Green      | 25357332 | None           |          | Campus Cream    | 624   |
| 502         | 1211-27-27B-69, 1027   | Regatta Blue    | 28657497 | Horizon Blue    | 25357331 | Onyx Black     | 2532247  | Horizon Blue    | 619   |
| 510         | 1011W-37-69W           | India Ivory     | 2535737  | Horizon Blue    | 25357331 | Onyx Black     | 2532247  | Horizon Blue    | 619   |
| 510         | 1011WD-37D-69WD        | India Ivory     | 2535737  | Horizon Blue    | 25357331 | None           |          | Driftwood Grey  | 623   |
| 511         | 1011W-27-69W           | India Ivory     | 2535737  | Regatta Blue    | 28657497 | Argent Silver  | 2894202  | Regatta Blue    | 639   |
| 511         | 1011WD-37D-69WD        | India Ivory     | 2535737  | Regatta Blue    | 28657497 | None           |          | Driftwood Grey  | 623   |
| 512         | 1011W-37-69W           | Campus Cream    | 25357211 | Woodland Green  | 28657333 | Argent Silver  | 2894202  | Woodland Green  | 621   |
| 512         | 1011WD-37D-69WD        | Campus Cream    | 25357211 | Woodland Green  | 28657333 | None           |          | Campus Cream    | 624   |
| 513         | 1011W-37-69W           | Woodland Green  | 28657333 | Campus Cream    | 25357211 | Onyx Black     | 2532247  | Campus Cream    | 624   |
| 513         | 1011WD-37D-69WD        | Woodland Green  | 28657333 | Campus Cream    | 25357211 | None           |          | Campus Cream    | 624   |
| 514         | 1011W-27-37-62-62F-69W | Saddle Brown    | 28655978 | Sahara Beige    | 25355979 | Onyx Black     | 2532247  | Sahara Beige    | 603   |
| 514         | 1211-27-27B-62F-69     | Saddle Brown    | 28655978 | Sahara Beige    | 25355979 | Onyx Black     | 2532247  | Sahara Beige    | 603   |
| 514         | 1011WD-37D-69WD        | Saddle Brown    | 28655978 | Sahara Beige    | 25355979 | None           |          | Sahara Beige    | 603   |
| 515         | 1011W-37-69W           | Sahara Beige    | 25355979 | Saddle Brown    | 28655978 | Argent Silver  | 2894202  | Saddle Brown    | 607   |

Returns require a return authorization number—Please call first. • Note: Product pricing and availability subject to change.



| Comb. No.              | Model Usage             | UPPER BODY      |          | LOWER BODY      |          | WHEEL STRIPING |          | WHEELS          |       |
|------------------------|-------------------------|-----------------|----------|-----------------|----------|----------------|----------|-----------------|-------|
|                        |                         | Color           | Duco No. | Color           | Duco No. | Color          | Duco No. | Color           | Dulux |
| <b>1953, continued</b> |                         |                 |          |                 |          |                |          |                 |       |
| 515                    | 1011WD-37D-69WD         | Sahara Beige    | 25355979 | Saddle Brown    | 28655978 | None           |          | Sahara Beige    | 603   |
| 516                    | 1011WD-37D-69WD         | India Ivory     | 25357337 | Sungold         | 25357336 | None           |          | Driftwood Grey  | 623   |
| 517                    | 1011W-69W               | Target Red      | 25357344 | India Ivory     | 25357337 | Argent Silver  | 2894202  | Target Red      | 626   |
| 517                    | 1011WD-69WD             | Target Red      | 25357344 | India Ivory     | 25357337 | None           |          | Driftwood Grey  | 623   |
| <b>1954</b>            |                         |                 |          |                 |          |                |          |                 |       |
| 554                    | 1011W-62F-69W           | Shoreline Beige | 25357602 | Bermuda Green   | 28157601 | Argent Silver  | 2894202  | Bermuda Green   | 645   |
| 554                    | 1211-69W                | Shoreline Beige | 25357602 | Bermuda Green   | 28157601 | Argent Silver  | 2894202  | Bermuda Green   | 645   |
| 554                    | Bel Air                 | Shoreline Beige | 25357602 | Bermuda Green   | 28157601 | None           |          | Bermuda Green   | 645   |
| 555                    | 1011W-11WA-69W          | India Ivory     | 25357337 | Surf Green      | 25357332 | Onyx Black     | 2532247  | Surf Green      | 620   |
| 555                    | 1011WD-69WD             | India Ivory     | 25357337 | Surf Green      | 25357332 | None           |          | Surf Green      | 620   |
| 556                    | 1011W-11WA-62F-69W      | India Ivory     | 25357337 | Horizon Blue    | 25357331 | Onyx Black     | 2532247  | Horizon Blue    | 619   |
| 556                    | Bel Air                 | India Ivory     | 25357337 | Horizon Blue    | 25357331 | None           |          | Horizon Blue    | 619   |
| 557                    | 1011W-11WA-69W-1211-69W | India Ivory     | 25357337 | Biscayne Blue   | 28157600 | Argent Silver  | 2894202  | Biscayne Blue   | 646   |
| 557                    | 1011WD-37D-69WD         | India Ivory     | 25357337 | Biscayne Blue   | 28157600 | None           |          | Biscayne Blue   | 646   |
| 558                    | 1011W-69W-1211-69W      | Bermuda Green   | 28157601 | Shoreline Beige | 25357602 | Onyx Black     | 2532247  | Shoreline Beige | 647   |
| 558                    | 1011-WD-37D-69WD        | Bermuda Green   | 28157601 | Shoreline Beige | 25357602 | None           |          | Shoreline Beige | 647   |
| 559                    | 1011W-62F-69W           | Shoreline Beige | 25357602 | Saddle Brown    | 28655978 | Argent Silver  | 2894202  | Saddle Brown    | 607   |
| 559                    | 1062D                   | Shoreline Beige | 25357602 | Saddle Brown    | 28655978 | None           |          | Saddle Brown    | 607   |
| 560                    | 1011W-11WA-69W-1211-69W | India Ivory     | 25357337 | Onyx Black      | 2532247  | Argent Silver  | 2894202  | Onyx Black      | 505   |
| 560                    | 1011WD-37D-69WD         | India Ivory     | 25357337 | Onyx Black      | 2532247  | None           |          | Onyx Black      | 505   |
| 561                    | 1011WA                  | India Ivory     | 25357337 | Romany Red      | 25354741 | Argent Silver  | 2894202  | Romany Red      | 506   |
| 561                    | 1037D                   | India Ivory     | 25357337 | Romany Red      | 25354741 | None           |          | Romany Red      | 506   |
| 562                    | 1011WA                  | Bermuda Green   | 28157601 | Fiesta Cream    | 25357604 | Onyx Black     | 2532247  | Fiesta Cream    | 650   |
| 562                    | 1011WD-37D-69WD         | Bermuda Green   | 28157601 | Fiesta Cream    | 25357604 | None           |          | Fiesta Cream    | 650   |
| 563                    | 1011WD-37D-69WD         | India Ivory     | 25357337 | Turquoise       | 25357605 | None           |          | Turquoise       | 651   |
| 564                    | 1011WD-37D-69WD         | Shoreline Beige | 25357602 | Pueblo Tan      | 25357606 | None           |          | Pueblo Tan      | 652   |
| 565                    | 1262F                   | Morocco Red     | 25357750 | Shoreline Beige | 25357602 | Onyx Black     | 2532247  | Shoreline Beige | 647   |
| 566                    | 1262F                   | Shoreline Beige | 25357602 | Morocco Red     | 25357750 | Argent Silver  | 2894202  | Morocco Red     | 658   |

NOTE: Any chemicals will be shipped domestic ground only (Lower 48 states only). No international shipping.

## Section 8C: Paint Combination & Trim Charts

### Trim Chart

Note: If trim is not listed under group in which it is used, refer to yardage material group #15.500.

| Comb. No.   | Material                    | Models                   |
|-------------|-----------------------------|--------------------------|
| <b>1941</b> |                             |                          |
| 115         | Tan Pile Fabric             | 1200 (exc. 1227B-27P-71) |
| 116         | Tan Striped Pile Fabric     | 1000                     |
| 117         | Tan Striped Cloth           | 1000                     |
| 118         | Tan Pile Fabric             | 1227B-27P                |
| 119         | Tan Pile Fabric             | 1227B-27P                |
| 120         | Tan Leather                 | Cbl.                     |
| 121         | Green Leather               | Cbl.                     |
| 122         | Blue Leather                | Cbl.                     |
| 123         | Red Leather                 | Cbl.                     |
| 124         | Blue-Grey Leather           | Sdl.                     |
| 126         | Tan and Brown Striped Cloth | 1069                     |
| 127         | Blue Cloth                  | 1011-19-27               |
| 128         | Green Cloth                 | 1011-19-27               |

| Comb. No.      | Material                 | Models           |
|----------------|--------------------------|------------------|
| <b>1942-46</b> |                          |                  |
| 129            | Greyish Tan Pile Fabric  | 1200 (exc. Sdl.) |
| 130            | Grey Striped Pile Fabric | 1011-19-27-27B   |
| 131            | Tan Novelty Bedford Cord | 1011-19-27-27B   |
| 132            | Tan Striped Fabric       | 1007-69          |
| 133            | Tan Leather              | Cbl.             |
| 134            | Grey Leather             | Cbl.             |
| 135            | Blue Leather             | Cbl.             |
| 136            | Red Leather              | Cbl.             |
| 137            | Blue-Grey Leather        | Sdl.             |
| 141            | Grey Striped Pile Fabric | 1007             |

| Comb. No.   | Material                 | Models        |
|-------------|--------------------------|---------------|
| <b>1946</b> |                          |               |
| 142         | Grey Striped Pile Fabric | 1009          |
| 179         | Tan Leather              | Station Wagon |

| Comb. No.   | Material                 | Models           |
|-------------|--------------------------|------------------|
| <b>1947</b> |                          |                  |
| 129         | Greyish Tan Pile Fabric  | 1200 (exc. Sdl.) |
| 130         | Grey Striped Pile Fabric | 1011-19-27-27B   |
| 131         | Tan Novelty Bedford Cord | 1011-19-27-27B   |
| 132         | Tan Striped Fabric       | 1007-69          |
| 137         | Blue-Grey Leather        | Sdl.             |
| 143         | Tan Leather              | Cbl.             |
| 144         | Blue Leather             | Cbl.             |
| 145         | Red Leather              | Cbl.             |
| 146         | Tan Leather              | Cbl.             |
| 147         | Blue Leather             | Cbl.             |
| 148         | Red Leather              | Cbl.             |
| 149         | Tan Leather              | Station Wagon    |

| Comb. No.   | Material                 | Models                    |
|-------------|--------------------------|---------------------------|
| <b>1948</b> |                          |                           |
| 137         | Blue-Black Leather       | Sdl.                      |
| 144         | Blue Leather             | Cbl.                      |
| 145         | Red Leather              | Cbl.                      |
| 149         | Tan Leather              | Station Wagon             |
| 150         | Gray Striped Pile Fabric | 1011-19-27-27B            |
| 151         | Tan Striped Pile Fabric  | 1011-19-21                |
| 152         | Tan Novelty Bedford Cord | 1011-19-27-1211-19-27-27B |
| 153         | Tan Striped Fabric       | 1007-69                   |

| Comb. No.          | Material                | Models           |
|--------------------|-------------------------|------------------|
| <b>1948, cont.</b> |                         |                  |
| 155                | Green Leather           | Cbl.             |
| <b>1949</b>        |                         |                  |
| 156                | Tan Striped Pile Fabric | 1200 (exc. Sdl.) |
| 157                | Tan Striped Pile Fabric | 1007-8-11-27-69  |
| 158                | Tan Striped Cloth       | 1007-8-11-27-69  |
| 160                | Red Leather             | Cbl.             |
| 161                | Blue Leather            | Cbl.             |
| 162                | Green Leather           | Cbl.             |
| 163                | Brown Leather           | Sdl.             |
| 166                | Brown Leather           | Station Wagon    |
| 167                | Black Leather           | Cbl.             |

| Comb. No.   | Material                       | Models                |
|-------------|--------------------------------|-----------------------|
| <b>1950</b> |                                |                       |
| 170         | Grey Striped Cloth             | 1200 (exc. Sdl.)      |
| 171         | Grey Striped Broadcloth        | 1000 (exc. CBL., B-A) |
| 175         | Red Leather—Grey Pile Cord     | Cbl.                  |
| 176         | Green Leather—Grey Pile Cord   | Cbl.                  |
| 177         | Blue Leather—Grey Pile Cord    | Cbl.                  |
| 179         | Black Leather—Grey Pile Cord   | Cbl.                  |
| 185         | Red Leather—Grey Pile Cord     | Bel Air               |
| 186         | Green Leather—Grey Pile Cord   | Bel Air               |
| 187         | Blue Leather—Grey Pile Cord    | Bel Air               |
| 189         | Black Leather—Grey Pile Cord   | Bel Air               |
| 195         | Red Leather—Tan Bedford Cord   | Cbl.                  |
| 196         | Green Leather—Tan Bedford Cord | Cbl.                  |
| 197         | Blue Leather—Tan Bedford Cord  | Cbl.                  |
| 199         | Black Leather—Tan Bedford Cord | Cbl.                  |
| 163         | Brown Leather                  | Sdl.                  |
| 166         | Brown Leather                  | Station Wagon         |

| Comb. No.   | Material                | Models        |
|-------------|-------------------------|---------------|
| <b>1951</b> |                         |               |
| 163         | Brown Imitation Leather | Sdl.          |
| 202         | Tan Imitation Leather   | Station Wagon |
| 172         | Grey Imitation Leather  | Taxi Cab      |

| Comb. No.   | Material                     | Models                            |
|-------------|------------------------------|-----------------------------------|
| <b>1952</b> |                              |                                   |
| 210         | Light Grey Pattern Cloth     | 1200 (exc. Sdl.)                  |
| 211         | Light Grey Chevron Cloth     | 1000 (exc. Conv., B-A, Sta. Wag.) |
| 211         | Dark Grey Broadcloth         | 1000 (exc. Conv., B-A, Sta. Wag.) |
| 212         | Light Blue Chevron Cloth     | 1000 (exc. Conv., B-A, Sta. Wag.) |
| 212         | Dark Blue Broadcloth         | 1000 (exc. Conv., B-A, Sta. Wag.) |
| 213         | Light Green Chevron Cloth    | 1000 (exc. Conv., B-A, Sta. Wag.) |
| 224         | Tan and Brown Leather        | Conv.                             |
| 225         | Red Leather                  | Conv.                             |
| 226         | Light and Dark Green Leather | Conv.                             |
| 227         | Light and Dark Blue Leather  | Conv.                             |
| 229         | Black Leather                | Conv.                             |
| 234         | Tan Leather—Brown Cloth      | Bel Air                           |
| 235         | Red Leather—Grey Cloth       | Bel Air                           |

Returns require a return authorization number—Please call first. • Note: Product pricing and availability subject to change.

| Comb. No. | Material | Models |
|-----------|----------|--------|
|-----------|----------|--------|

**1952, continued**

|     |                             |               |
|-----|-----------------------------|---------------|
| 236 | Green Leather—Green Cloth   | Bel Air       |
| 237 | Blue Leather—Blue Cloth     | Bel Air       |
| 239 | Black Leather—Grey Cloth    | Bel Air       |
| 240 | White Leather—Coral Cloth   | Bel Air       |
| 216 | Dark Grey Imitation Leather | Sdl.          |
| 218 | Tan Imitation Leather       | Station Wagon |
| 214 | Grey Imitation Leather      | Taxi Cab      |

**1953**

|     |  |                              |
|-----|--|------------------------------|
| 241 | Light Grey—Dark Grey Pattern Cloth       | 1000 (exc. Conv., Sta. Wag.) |
| 242 | Light Blue—Dark Blue Pattern Cloth       | 1000 (exc. Conv., Sta. Wag.) |
| 253 | Light Green—Dark Green Pattern Cloth     | 1000 (exc. Conv., Sta. Wag.) |
| 244 | Light Tan—Brown Pattern Cloth            | 1000 (exc. Conv., Sta. Wag.) |
| 249 | Light Grey Pattern Cloth                 | 1200 (exc. Sta. Wag., Sdl.)  |
| 245 | Light Grey Ladder Pattern & Plain Cloth  | 1011 WD, 1069 WD             |
| 246 | Light Blue Ladder Pattern & Plain Cloth  | 1011 WD, 1069 WD             |
| 247 | Light Green Ladder Pattern & Plain Cloth | 1011 WD, 1069 WD             |
| 248 | Light Tan Ladder Pattern & Plain Cloth   | 1011 WD, 1069 WD             |
| 254 | Light Tan Pattern Cloth                  | 1037 D                       |
| 254 | Tan Imitation Leather                    | 1037 D                       |
| 256 | Light Green Pattern Cloth                | 1037 D                       |
| 256 | Light Green Imitation Leather            | 1037 D                       |
| 257 | Light Blue Pattern Cloth                 | 1037 D                       |
| 257 | Light Blue Imitation Leather             | 1037 D                       |
| 258 | Yellow & White Pattern Cloth             | 1037 D                       |
| 258 | White Imitation Leather                  | 1037 D                       |
| 259 | Black & White Pattern Cloth              | 1037 D                       |
| 259 | White Imitation Leather                  | 1037 D                       |
| 284 | Brown—Tan Imitation Leather              | 1067                         |
| 285 | Red Imitation Leather                    | 1067                         |
| 286 | Dark Green—Light Green Imitation Leather | 1067                         |
| 287 | Dark Blue—Light Blue Imitation Leather   | 1067                         |
| 264 | Brown—Tan Imitation Leather              | 1067 D                       |
| 265 | Red—White Imitation Leather              | 1067 D                       |
| 266 | Dark Green—Light Green Imitation Leather | 1067 D                       |
| 267 | Dark Blue—Light Blue Imitation Leather   | 1067 D                       |
| 268 | Yellow—White Imitation Leather           | 1067 D                       |
| 269 | Black—White Imitation Leather            | 1062, 1062 F                 |
| 278 | Beige—Brown Imitation Leather            | 1062, 1062 F, 1262 F         |
| 280 | Beige—Green Imitation Leather            | 1062, 1062 F                 |
| 277 | Light Green Imitation Leather            | 1262 F                       |
| 276 | Beige Imitation Leather                  | 1271                         |
| 278 | Beige—Brown Imitation Leather            | 1062, 1062 F, 1262 F         |
| 280 | Beige—Green Imitation Leather            | 1062, 1062 F                 |
| 277 | Light Green Imitation Leather            | 1262 F                       |
| 276 | Beige Imitation Leather                  | 1271                         |

| Comb. No. | Material | Models |
|-----------|----------|--------|
|-----------|----------|--------|

**1954**

|     |  |                             |
|-----|--|-----------------------------|
| 300 | Light Grey Pattern Cloth                               | 1200 (exc. Sta. Wag., Sdl.) |
| 332 | Light Blue—White Imitation Leather                     | 1011 WA                     |
| 333 | Light Green—White Imitation Leather                    | 1011 WA                     |
| 334 | Black—White Imitation Leather                          | 1011 WA                     |
| 304 | Light Grey Pattern—Dark Grey Pattern Cloth             | 1011 W-69 W                 |
| 305 | Light Blue Pattern—Dark Blue Pattern Cloth             | 1011 W-69 W                 |
| 306 | Light Green Pattern—Dark Green Plain Cloth             | 1011 W-69 W                 |
| 307 | Light Tan Pattern—Dark Brown Plain Cloth               | 1011 W-69 W                 |
| 309 | Dark Grey Pattern Cloth—Light Grey Imitation Leather   | 1011 WD-69 WD               |
| 310 | Dark Blue Pattern Cloth—Light Blue Imitation Leather   | 1011 WD-69 WD               |
| 311 | Dark Green Pattern Cloth—Light Green Imitation Leather | 1011 WD-69 WD               |
| 330 | Beige Pattern Cloth—Dark Tan Imitation Leather         | 1011 WD-69 WD               |
| 331 | Turquoise Pattern Cloth—White Imitation Leather        | 1011 WD-69 WD               |
| 325 | Red—White Imitation Leather                            | Conv.                       |
| 326 | Dark Green—Light Green Imitation Leather               | Conv.                       |
| 327 | Dark Blue—Light Blue Imitation Leather                 | Conv.                       |
| 328 | Beige—Tan Imitation Leather                            | Conv.                       |
| 329 | Black—White Imitation Leather                          | Conv.                       |
| 337 | Turquoise—White Imitation Leather                      | Conv.                       |
| 314 | Dark Blue Pattern Cloth—Light Blue Imitation Leather   | Spt. Cpe.                   |
| 315 | Dark Green Pattern Cloth—Light Green Imitation Leather | Spt. Cpe.                   |
| 316 | Red Pattern Cloth—White Imitation Leather              | Spt. Cpe.                   |
| 317 | Turquoise Pattern Cloth—White Imitation Leather        | Spt. Cpe.                   |
| 318 | Beige Pattern Cloth—Tan Imitation Leather              | Spt. Cpe.                   |
| 319 | Black Pattern Cloth—White Imitation Leather            | Spt. Cpe.                   |
| 323 | Green—Straw Imitation Leather                          | 1062 D-62 F                 |
| 324 | Beige—Straw Imitation Leather                          | 1062 D-62 F                 |
| 322 | Maroon—Beige Imitation Leather                         | 1262 F                      |
| 303 | Grey Imitation Leather                                 | 1271                        |
| 371 | Green Imitation Leather                                | 1262 F                      |

NOTE: Any chemicals will be shipped domestic ground only (Lower 48 states only). No international shipping.

Phone: (360) 816-0211 • (800) 999-CHEV (2438) • www.chevsofthe40s.com



**SECTION 010C  
RESTORATION PARTS**

**Gift Certificates**



**GIFTCERT0025...ALL**  
\$25 Gift Certificate -0 ..

**\$25.00 EA** ⚠️

**GIFTCERT0050.....ALL**

\$50 Gift Certificate -0 .. **\$50.00 EA**



**GIFTCERT0075.....ALL**

\$75 Gift Certificate -0 .. **\$75.00 EA**



**GIFTCERT0100.....ALL**

\$100 Gift Certificate -0 ..

**\$100.00 EA** ⚠️

**GIFTCERT0150.....ALL**

\$150 Gift Certificate -0 ..

**\$150.00 EA** ⚠️

**GIFTCERT0200.....ALL**

\$200 Gift Certificate -0 ..

**\$200.00 EA** ⚠️

**GIFTCERT0500.....ALL**

\$500 Gift Certificate -0 ..

**\$500.00 EA** ⚠️

**GIFTCERT1000.....ALL**

\$1000 Gift Certificate -0 ..

**\$1,000.00 EA** ⚠️

**GIFTCERT5000.....ALL**

\$5000 Gift Certificate -0 ..

**\$5,000.00 EA** ⚠️

**Fender/Trunk Script Emblems**



**R6274.....ALL**

"Hotrod" Emblem -0.2 .. **\$13.75 EA** ⚠️



**R6276.....ALL**

"Blown" Emblem -0.15 .. **\$9.50 EA** ⚠️



**R6278.....ALL**

"Turbocharged" Emblem -0.15 ..

**\$7.75 EA** ⚠️

**Vehicle Accessories**



**CHEVSFRESH...37-64**  
Chevs of the 40s air freshener, detail spray scent -0 .. **\$2.50 EA** ⚠️

**Vehicle Accessories, cont.**



**10887.....ALL**

Chrome bullet wing nut license fastener.

Set of 4 -0.15 .. **\$6.25 SET** ⚠️

**8BALL70204...ALL**

Fuzzy 8 Ball

Black -0.15 .. **\$7.75 EA** ⚠️



**985094.....ALL**

Glass jewel reflector. Specify Red, Green, Blue, Amber, Burnt Orange, Purple, Clear, Light Blue, Yellow, Rainbow. (2 pcs).

9.777 -0.2 .. **starting at \$20.00 PR** ⚠️



**DICE.....ALL**

Classic Fuzzy Dice, Chose Black, Blue or Red -0.15 .. **\$5.00 PR** ⚠️

**DLK70023...ALL**

8 Ball Door Lock

Knob -0.15 .. **\$7.75 PR** ⚠️



**DLK70044...ALL**

Chrome Metal Tube Door Lock Knob -0.2

..... **\$8.00 PR** ⚠️



**Vehicle Accessories, cont.**



**FLAG01.....ALL**

License Plate Frame Accessory, U.S.A.

Flag -0.4 .. **\$3.25 EA** ⚠️



**FLAG02.....ALL**

Flag Holder -chrome 5 Post -0.15

..... **\$12.00 EA** ⚠️



**FLAG03.....ALL**

Flag Holder-Chrome 3 Post -0.15

..... **\$12.25 EA** ⚠️



**LF70045.....ALL**

8 Ball License Plate Fastener -0.2

..... **\$6.50 PR** ⚠️



**LF70065.....ALL**

Lion Head License Plate Fastener -0.2

..... **\$7.75 PR** ⚠️



**LF70070.....ALL**

Chrome Dice License Plate Fastener -0.2

..... **\$6.75 PR** ⚠️



**Vehicle Accessories, cont.**



**LF70071.....ALL**  
 Chrome Bullet License Plate Fastener -0.2  
 ..... **\$8.75 PR** ⚠️



**LF70072.....ALL**  
 Dice License Plate Fastener Green With White Dots -0.15  
 ..... **\$5.00 PR** ⚠️



**LF70073.....ALL**  
 Dice License Plate Fastener Purple With White Dots -0.15  
 ..... **\$5.50 PR** ⚠️



**LF70074.....ALL**  
 Large 8 Ball License Plate Fastener -0.15  
 ..... **\$7.00 PR** ⚠️



**LF70096.....ALL**  
 Iron Cross License Plate Fastener -0.15  
 ..... **\$6.00 PR** ⚠️



**LF70315.....ALL**  
 Chrome Skull License Plate Fastener -0.15  
 ..... **\$6.75 PR** ⚠️

**Vehicle Accessories, cont.**



**VC69978.....ALL**  
 Chrome Large 8 Ball Valve Cap -0.2  
 ..... **\$11.00 SET** ⚠️



**VC69981.....ALL**  
 Chrome Dice Valve Caps -0  
 ..... **CALL** ⚠️



**VC70004.....ALL**  
 Skull Valve Caps -0.15  
 ..... **\$7.25 SET** ⚠️



**VC70005.....ALL**  
 Dice Valve Caps-Red With White Dots -0.15  
 ..... **\$5.00 SET** ⚠️



**VC70006.....ALL**  
 Dice Valve Caps-White With Black Dots -0.15  
 ..... **\$5.00 SET** ⚠️



**VC70007.....ALL**  
 Dice Valve Caps-Black With White Dots -0.15  
 ..... **\$5.00 SET** ⚠️



**VC70008.....ALL**  
 Dice Valve Caps-Blue With White Dots -0.15  
 ..... **\$5.00 SET** ⚠️

**Vehicle Accessories, cont.**



**VC70022.....ALL**  
 8 Ball Valve Caps -0.15  
 ..... **\$5.00 SET** ⚠️



**VC70038.....ALL**  
 Chrome Spike Valve Caps -0.15  
 ..... **\$8.75 SET** ⚠️



**VINTAGE01.....ALL**  
 Registration holder for your column w/ springs. 5-1/4" X 3-1/4" -0.15  
 ..... **\$14.00 EA** ⚠️



**VINTAGE02.....ALL**  
 Registration holder w/ clamps for your Sun Visor. Reproduction protector for your registration card. 5-1/4" x 3-3/8" -0.15  
 ..... **\$13.25 EA** ⚠️



**WASITFD.....ALL**  
 Bluetooth speaker fuzzy dice. Easy setup with built in microphone & stereo speakers makes hands free calling safe & easy. Works with your

smart phone for calling, music, navigation & more. Rechargeable long play battery. USB charging cord included. Great in the shop or at cruise nights too. -0.15

..... **\$109.25 EA** ⚠️

**T-Shirts**

**SHIRTO1.....ALL**  
 Chev's Logo T-Shirt. Available in Red, White, Blue or Black. S, M, L, XL, XXL, XXXL -0.15  
 ..... **\$15.00 EA** ⚠️

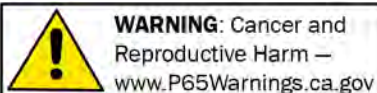

Chemicals shipped domestic ground only (Lower 48 states only). No international shipping.

**Phone: (360) 816-0211 • (800) 999-CHEV (2438) • www.chevsofthe40s.com**



**T-Shirts, cont.**



**SHIRT04 . . . . .ALL**  
 '41 Cabriolet "Bustin Through". Available in Black or Blue. S, M, L, XL, XXL, XXXL -0.15  
 . . . . . **\$15.00 EA** ⚠



**SHIRT07 . . . . .ALL**  
 47-53 Truck "Bustin Through". Available in black or blue, S, M, L, XL, XXL, XXXL -0.15  
 . . . . . **\$15.00 EA** ⚠



**SHIRT08 . . . . .ALL**  
 T-Shirt "52 Bustin' Through". Available in black or blue, S, M, L, XL, XXL, XXXL -0.15  
 . . . . . **\$15.00 EA** ⚠



**SHIRT09 . . . . .ALL**  
 T-Shirt "39 Bustin' Through". Available in black or blue, S, M, L, XL, XXL, XXXL -0.15  
 . . . . . **\$15.00 EA** ⚠



**SHIRT10 . . . . .ALL**  
 T-Shirt "37 Bustin' Through". Available in black or blue, S, M, L, XL, XXL, XXXL -0.15  
 . . . . . **\$15.00 EA** ⚠



**SHIRT11 . . . . .ALL**  
 T-Shirt "40 Bustin' Through". Available in black or red, S, M, L, XL, XXL, XXXL -0.15  
 . . . . . **\$15.00 EA** ⚠



**SHIRT13 . . . . .ALL**  
 Street Rod Headquarters basic Available in black. S, M, L, XL, XXL, XXXL -0  
 . . . . . **\$15.00 EA** ⚠

**Hoodies**



**HOODIE-CH1 . . . . .ALL**  
 Large or XL cotton hoodies with Chevs chest logo. Choose Black, Blue, Grey, Navy or Red. 0.000 -0.15  
 . . . . . **\$31.00 EA** ⚠

**HOODIE-CH2 . . . . . ALL**  
 XXL ( Black, Blue, Grey, Navy or Red.) or XXXL ( Black, Blue, Grey, Navy or Red.). Single Chevs logo on left chest. 0.000 -0  
**\$24.50 EA** ⚠

**Hats**



**HAT-CHEVS1B. . . . .ALL**  
 Black preformed ball cap with Chevs embroidered logo and red, white & blue detailing on brim. One size fits all with velcro closure. -0.15  
**\$14.00 EA** ⚠



**HAT-CHEVS1N. . . . .ALL**  
 Navy preformed ball cap with Chevs embroidered logo and red, white & blue detailing on brim. One size fits all with velcro closure. -0.15  
**\$14.00 EA** ⚠



**HAT-CHEVS2 . . . . .ALL**  
 Beanie/ Stocking cap 8". Navy with Chevs embroidered logo. One size fits all. -0.15  
**\$14.00 EA** ⚠



**HAT-CHEVS3 . . . . .ALL**  
 Beanie/ Stocking cap 12". Navy with Chevs embroidered logo. One size fits all. -0.15  
**\$14.00 EA** ⚠

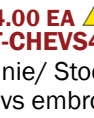

**HAT-CHEVS4. . . . .ALL**  
 Beanie/ Stocking cap 12". Black with Chevs embroidered logo. One size fits all. -0.15  
**\$14.00 EA** ⚠



**HAT-CHEVS5 . . . . .ALL**  
 Beanie/ Stocking cap 8". Black with Chevs embroidered logo. One size fits all. -0.15  
**\$14.00 EA** ⚠

**Vintage Chevrolet Cooler**



**BLACKCOOLER . . . . .ALL**  
 Black beverage cooler. 16-1/2" x 7-1/2" x 9-3/8" internal dimensions. 0.000 -0  
**\$92.50 EA** ⚠



**BLUECOOLER . . . . .ALL**  
 Blue beverage cooler. 16-1/2" x 7-1/2" x 9-3/8" internal dimensions. 0.000 -0  
**\$92.50 EA** ⚠



**REDCOOLER . . . . .ALL**  
 Red beverage cooler. 16-1/2" x 7-1/2" x 9-3/8" internal dimensions. 0.000 -0  
**\$92.50 EA** ⚠

**Artwork**



**ART3 . . . . .ALL**  
 Chevy Farm. 15" X 30" color print of classic cars. Limited print run of 650. 0.000 -0.15  
**\$75.00 EA** ⚠

**Wall Clocks**

Neon to light up your garage, den, workshop or anywhere you can find a place for these large clocks.



**CLOCK01GMMPALL**  
 Antique Sinclair Green Neon -0.15  
 . . . . . **\$159.00 EA** ⚠



Wall Clocks, cont.



**CLOCK01RMMPALL**  
Antique Sinclair Red  
Neon -0.15  
..... **\$159.00 EA** ⚠



**CLOCK02MMP .ALL**  
Chevy Garage Blue  
Neon -0.15  
..... **\$159.00 EA** ⚠



**CLOCK03MMP .ALL**  
Ford Motor Co Blue  
Neon -0.15  
..... **\$159.00 EA** ⚠



**CLOCK04MMP .ALL**  
Gear Head Blue  
Neon -0.15  
..... **\$159.00 EA** ⚠



**CLOCK05MMP .ALL**  
Genuine Chevy Parts  
Blue Neon -0.15  
..... **\$203.75 EA** ⚠



**CLOCK06MMP .ALL**  
GMC Truck White  
Neon -0.15  
..... **\$159.00 EA** ⚠



**CLOCK07MMP .ALL**  
GULF Blue  
Neon -0.15  
..... **\$159.00 EA** ⚠

Wall Clocks, cont.



**CLOCK08BMMPALL**  
Mobile Gas Blue  
Neon -0.15  
..... **\$205.00 EA** ⚠



**CLOCK08RMMPALL**  
Mobile Gas Red  
Neon -0.15  
..... **\$159.00 EA** ⚠



**CLOCK09MMP .ALL**  
Moon Eyes Yellow  
Neon -0.15  
..... **\$178.50 EA** ⚠



**CLOCK10MMP .ALL**  
Penzoil Red  
Neon -0.15  
..... **\$159.00 EA** ⚠



**CLOCK11MMP .ALL**  
Road Runner Orange  
Neon -0.15  
..... **\$159.00 EA** ⚠



**CLOCK12MMP .ALL**  
Corvette Garage Red  
Neon -0.15  
..... **\$159.00 EA** ⚠



**CLOCK13MMP .ALL**  
Genuine Ford Parts  
Blue Neon -0.15  
..... **\$181.75 EA** ⚠

Wall Clocks, cont.



**CLOCK14MMP .ALL**  
Poly Gas Green  
Neon -0.15  
..... **\$159.00 EA** ⚠



**CLOCK15MMP .ALL**  
Pontiac Service Red  
Neon -0.15  
..... **\$159.00 EA** ⚠



**CLOCK16MMP .ALL**  
Sunoco Gas Yellow  
Neon -0.15  
..... **\$159.00 EA** ⚠



**CLOCK17MMP .ALL**  
76 Gas Blue  
Neon -0.15  
..... **\$159.00 EA** ⚠



**CLOCK18MMP .ALL**  
Olds Rocket Red  
Neon -0.15  
..... **\$159.00 EA** ⚠



**CLOCK19MMP .ALL**  
Rat Fink Green  
Neon -0.15  
..... **\$159.00 EA** ⚠



**CLOCK20MMP .ALL**  
HURST Red  
Neon -0.15  
..... **\$159.00 EA** ⚠



**WARNING:** Cancer and Reproductive Harm — [www.P65Warnings.ca.gov](http://www.P65Warnings.ca.gov)

Chemicals shipped domestic ground only (Lower 48 states only). No international shipping.

Phone: (360) 816-0211 • (800) 999-CHEV (2438) • [www.chevsofthe40s.com](http://www.chevsofthe40s.com)



**Wall Clocks, cont.**



**CLOCK21MMP .ALL**  
Super Chevy Service  
Yellow Neon -0.15  
..... **\$159.00 EA** ⚠



**CLOCK22MMP .ALL**  
Gilmore Gas red  
Neon -0.15  
..... **\$159.00 EA** ⚠



**CLOCK23BMMPALL**  
OK Used Cars Blue  
Neon -0.15  
..... **\$159.00 EA** ⚠



**CLOCK23RMMPALL**  
OK Used Cars Red  
Neon -0.15  
..... **\$159.00 EA** ⚠

**Wall Sign**



**CHEVYGAR** .....**ALL**  
Polished stainless steel, laser cut "Chevy Garage" wall sign. 32" x 13" tall. Great for any garage, office or game room. -0.15  
**\$49.00 EA** ⚠

**Stools**



**STOOLB1** .....**ALL**  
Buick Service.  
0.000 -0.15  
..... **\$125.00 EA** ⚠

**Stools, cont.**



**STOOLB2** .....**ALL**  
Chevy Bowtie.  
0.000 -0.15  
..... **\$125.00 EA** ⚠



**STOOLB3** .....**ALL**  
Belair w/ backrest.  
0.000 -0.15  
..... **\$165.00 EA** ⚠



**STOOLG1** .....**ALL**  
GMC Trucks.  
0.000 -0.15  
..... **\$125.00 EA** ⚠



**STOOLO1** .....**ALL**  
Oldsmobile Service.  
0.000 -0.15  
..... **\$125.00 EA** ⚠



**STOOLP** .....**ALL**  
Chevrolet Parts.  
Yellow, red and blue swivel seat.  
0.000 -0.15  
..... **\$125.00 EA** ⚠



**STOOLP1** .....**ALL**  
Pontiac Service.  
0.000 -0.15  
..... **\$125.00 EA** ⚠



**STOOLPB** .....**ALL**  
Chevrolet Parts.  
Yellow, red and blue swivel with backrest.  
0.000 -0.15  
..... **\$165.00 EA** ⚠

**Stools, cont.**



**STOOLS** .....**ALL**  
Chevrolet Service stool. Blue and white swivel seat.  
0.000 -0.15  
..... **\$125.00 EA** ⚠



**STOOLSB** .....**ALL**  
Chevrolet Service. Blue and white swivel seat with backrest. 0.000 -0.15  
..... **\$150.00 EA** ⚠

**Car Wash & Cleaners**



**ADPD001** .....**ALL**  
"Car Shampoo" Adam's soap, specially-formulated Car Wash Soap is pH-balanced

and won't strip the protective coating off your finish. This soap suds like crazy and is biodegradable. New formula can be used in a foam gun or foam cannon. 16 oz. bottle. 8.800 -0.15 ..... **\$11.00 EA** ⚠



**ADPD011** .....**ALL**  
"CARPET & UPHOLSTERY CLEANER", Adam's Non-toxic, non-

allergenic cleaner. Contains no soap and will not create suds. 8.800 -0.15 ..... **\$13.00 EA** ⚠



**ADPD012** .....**ALL**  
"GLASS CLEANER", Adam's Glass Cleaner out performs the competition and you will

love it. 16oz. spray bottle. 8.800 -0.15 ..... **\$15.25 EA** ⚠

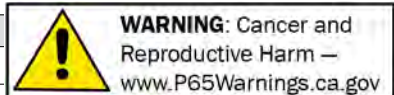

**Car Wash & Cleaners, cont.**



**ADPD014 .....ALL**  
 "UNDERCARRIAGE  
 SPRAY" Adam's All  
 Purpose Cleaner. Don't  
 let ugly, soiled wheel

wells ruin your beautiful detail job! Spray Adams All Purpose Cleaner in your fender wells and give them a good scrubbing with a fender brush. Let the cleaner dwell while you clean the tire and wheel, then give everything a thorough rinsing. After washing, allow to air dry, blow dry or towel dry then spray a light coating of Invisible Undercarriage Spray to all areas of the fender well, then work the product in with an old towel. When you're finished, your black fender well liners will have a perfect satin black finish. Works great for engine bays too!! 16oz. spray bottle. 8.800 -0.15

..... **\$14.00 EA** ⚠️



**ADPD015 .....ALL**  
 "ALL-PURPOSE  
 CLEANER", Adam's  
 heavy duty w/ lemon  
 scent. Tough on dirt but

easy on your car. Cleans wheels, tires, engines, and more. Safely cleans your foam buffing & polishing pads. 16oz. Spray bottle. 8.800 -0.15

..... **\$11.75 EA** ⚠️

**ADPDEWC16 .....ALL**  
 Wheel Cleaner For Delicate Wheel  
 Finishes. 8.800 -0

..... **\$12.00 EA** ⚠️



**ADPDWC16 .....ALL**  
 "DEEP WHEEL  
 CLEANER" the ultimate  
 way to remove stubborn  
 brake dust and metallic

contamination from your wheels. Adam's 36oz. spray. 8.800 -0.15

..... **\$19.25 EA** ⚠️

**ADPDWC1GAL ....ALL**  
 "DEEP WHEEL  
 CLEANER" the ultimate  
 way to remove stubborn  
 brake dust and metallic

contamination from your wheels. Adam's 1 Gallon 8.800 -0.15

..... **\$70.00 EA** ⚠️



**ADPG001 .....ALL**  
 "CAR Shampoo" Adam's  
 soap, specially-  
 formulated Car Wash  
 Soap is pH-balanced

and won't strip the protective coating off your finish. This soap suds like crazy and is biodegradable. New formula can be used in a foam gun or foam cannon. 1 gallon. 8.800 -0.15

..... **\$46.75 EA** ⚠️

**Car Wash & Cleaners, cont.**



**ADPTID16 .....ALL**  
 "TOTAL INTERIOR  
 DETAILER SPRAY" is  
 your one step solution  
 for a clean, dressed,

and factory looking interior. Adam's 16 oz. bottle. 8.800 -0.15

..... **\$14.00 EA** ⚠️



**ADPTID1GAL .....ALL**  
 "TOTAL INTERIOR  
 DETAILER" is your one  
 step solution for a  
 clean, dressed, and

factory looking interior. Adam's 1 Gallon. 8.800 -0.15

..... **\$46.75 EA** ⚠️

**Wax & Polish**



**ADPD004 .....ALL**  
 "REVIVE HAND POLISH",  
 removes moderate  
 oxidation, swirl marks,  
 and fading, Adam's 14

ounces. 8.800 -0.15

..... **\$17.75 EA** ⚠️



**ADPD005 .....ALL**  
 "SWIRL & HAZE  
 REMOVER", Adam's 16  
 oz. Not a rubbing  
 compound and less

abrasive than toothpaste. Gently removes scratches from clearcoats and painted surfaces. For use by hand or machine. For best results, combine with Revive Polish. 8.800 -0.15

..... **\$19.00 EA** ⚠️



**ADPD006 .....ALL**  
 "BUTTER WAX", Adam's  
 16 oz. bottle. Contains  
 special blend of  
 polymers, resins and

natural Carnauba without cleaners or abrasives and will not stain plastic or rubber. Use Clay Bar and Revive Polish on imperfect finishes before applying Butter Wax. 12-oz bottle covers many vehicles. 8.800 -0.15

..... **\$23.50 EA** ⚠️



**ADPD007 .....ALL**  
 "BRILLIANT GLAZE",  
 Adam's 16 oz. bottle.  
 Add depth and clarity to  
 chrome, glass and

paintwork. Extreme ease of use with ultra-high gloss results. Not for use on oxidized finishes. 8.800 -0.15

..... **\$29.25 EA** ⚠️

**Wax & Polish**



**ADPD017 .....ALL**  
 "FINE MACHINE  
 POLISH", Adam's 16  
 oz. Polish your car's  
 clearcoat to a jewel-like

finish. Designed for application by dual-action car polishers. After just one or two uses, your clearcoat will have perfect clarity so you can enjoy all of the rich color below. Use it several times a year to maintain perfect gloss, without thinning your clearcoat.

To protect your finely polished finish, follow up with Machine Super Wax or Buttery Wax. Both products will add additional gloss, depth and rich color. 8.800 -0.15

..... **\$25.00 EA** ⚠️



**ADPD018 .....ALL**  
 "MACHINE SUPER  
 SEALANT", Protect your  
 paint for months in just  
 a matter of minutes.

Easy application and built to last through the toughest elements.. 16oz. 8.800 -0.15

..... **\$26.75 EA** ⚠️

**Metal Polish**



**ADPD009 .....ALL**  
 "METAL POLISH #1"  
 Adam's Works on  
 stainless, brass, billet,  
 chrome, and nickel (for

use on non-clear coated parts). 8.800 -0.15

..... **\$23.50 EA** ⚠️



**ADPD010 .....ALL**  
 "METAL POLISH #2",  
 Adam's contains no  
 abrasives. Highest gloss  
 metal polish on the

market w/ effortless application. Keep a mirror-like finish on brass, stainless, billet, nickel, and chrome. 8.800 -0.15

..... **\$43.00 EA** ⚠️

**Dressing & Conditioners**



**ADPD002LR ....37-64**  
 Pumpkin spice scented  
 "DETAIL SPRAY",  
 Adam's 16 oz. bottle.  
 We use this spray and it

works! A waterless car wash, clay bar lubricant or to enhance the depth and clarity of paint, chrome, plastic, aluminum, and glass. Removes dirt, smudges and grime, leaving surfaces with a smooth, ultra-high gloss finish. Use in the sun or shade, and in hot or cool temperatures. 8.800 -0.15

..... **\$13.00 EA** ⚠️

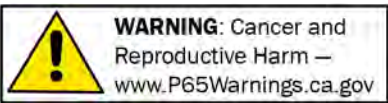

Chemicals shipped domestic ground only (Lower 48 states only). No international shipping.

**Phone: (360) 816-0211 • (800) 999-CHEV (2438) • www.chevsofthe40s.com**



**Dressing & Conditioners**



**ADPD020 .....37-64**  
 "H2O Guard & Gloss"  
 Adam's 16oz spray  
 bottle. Delivers lasting  
 protection and

unmatched gloss in a unique water-  
 activated formula that's fast and easy to  
 apply. The patented blend of acrylic resins  
 and water activated nano-polymers leaves  
 your paint slick and protected. The optical  
 grade resins and detergent resistant  
 polymers provide months of protection for  
 any exterior surface including paint, trim,  
 and glass. -0.15 ..... **\$17.00 EA** ⚠



**ADPD002 .....ALL**  
 "DETAIL SPRAY",  
 Adam's 16 oz. bottle.  
 We use this spray and it  
 works! A waterless car

wash, clay bar lubricant or to enhance the  
 depth and clarity of paint, chrome, plastic,  
 aluminum, and glass. Removes dirt,  
 smudges and grime, leaving surfaces with  
 a smooth, ultra-high gloss finish. Use in  
 the sun or shade, and in hot or cool  
 temperatures. 8.800 -0.15 .. **\$15.00 EA**  
 ⚠

**ADPD002C .....ALL**  
 "DETAIL SPRAY", Adam's 16 oz. bottle. We  
 use this spray and it works! A waterless  
 car wash, clay bar lubricant or to enhance  
 the depth and clarity of paint, chrome,  
 plastic, aluminum, and glass. Removes  
 dirt, smudges and grime, leaving surfaces  
 with a smooth, ultra-high gloss finish. Use  
 in the sun or shade, and in hot or cool  
 temperatures. 8.800 -0 .. **\$15.00 EA** ⚠



**ADPD003 .....ALL**  
 "V.R.T." RUBBER  
 DRESSING, Adam's 12  
 oz. bottle. Enhance &  
 protect plastic, rubber,

tires, moldings, dashboards and door  
 panels. Applies easily with a sponge  
 without a greasy film. Adds U.V. protection  
 to keep vehicle interiors and exteriors  
 looking and feeling like new. 8.800 -0.15  
 ..... **\$23.50 EA** ⚠



**ADPD008 .....ALL**  
 "LEATHER  
 CONDITIONER", Adam's  
 Nourish and conditions  
 leather upholstery with

this thick, non-greasy cream. Contains  
 U.V. blocking agents and will never dry  
 your leather. 16 oz. bottle. 8.800 -0.15  
 ..... **\$29.25 EA** ⚠

**Dressing & Conditioners**



**ADPD013 .....ALL**  
 "IN & OUT SPRAY",  
 Adam's restores badly  
 faded plastic, rubber,  
 flat painted surfaces

and AC vents to their original luster and  
 shine. 8.800 -0.15 ..... **\$16.00 EA** ⚠



**ADPD016 .....ALL**  
 "TIRE SHINE" Adam's  
 Tire Shine gives you a  
 Lustrous deep and Long  
 lasting Shine or the Wet

look. 8.800 -0.15 ..... **\$17.50 EA** ⚠



**ADPG002 .....ALL**  
 "DETAIL SPRAY",  
 Adam's 1 gallon refill.  
 We use this spray and it  
 works! A waterless car

wash, clay bar lubricant or to enhance the  
 depth and clarity of paint, chrome, plastic,  
 aluminum, and glass. Removes dirt,  
 smudges and grime, leaving surfaces with  
 a smooth, ultra-high gloss finish. Use in  
 the sun or shade, and in hot or cool  
 temperatures. 8.800 -0.15 .. **\$45.25 EA**  
 ⚠



**ADPG003 .....ALL**  
 "V.R.T." RUBBER  
 DRESSING, Adam's 1  
 gallon refill. Enhance &  
 protect plastic, rubber,

tires, moldings, dashboards and door  
 panels. Applies easily with a sponge  
 without a greasy film. Adds U.V. protection  
 to keep vehicle interiors and exteriors  
 looking and feeling like new. 8.800 -0.15  
 ..... **\$105.00 EA** ⚠

**303 Aerospace Protectant**

Keeps UV-sensitive materials "like new"  
 year after year. Gives 100% prevention of UV  
 caused slow-fade with regular use. No other  
 protectant beautifies as intensely, protects as  
 powerfully or lasts as long.

**Clay Bar**



**ADPA001 .....ALL**  
 "CLAY BAR", Adam's  
 removes surface  
 contamination without  
 skid or swirl marks. The large 4-oz bar is  
 suitable for 8-10 vehicles. 8.800 -0.15 ..

**\$12.25 EA** ⚠

**Wash Pad**



**ADPP010 .....ALL**  
 Adam's 10" Car Wash Pad.  
 Made of plush synthetic wool to ensure  
 you are washing without introducing new  
 swirls or scratches! -0.15 ..... **\$10.00 EA**  
 ⚠

**Detail Sponge & Applicators**

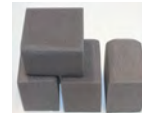

**ADPA003 .....ALL**  
 Large washable sponge  
 applies a thin, even  
 coat of Adam's Vinyl,  
 Rubber, & Tire (V.R.T.)

without the mess. 4 sponges. 8.800 -0.15  
 ..... **\$11.00 SET** ⚠



**ADPBRSWAB15 .....ALL**  
 "Interior Detailing Swabs", Adam's 15  
 Pack 8.800 -0.15 ..... **\$12.75 SET** ⚠

**ADPBRSWAB6 .....ALL**  
 "Interior Detailing Swabs", Adam's 6 Pack  
 8.800 -0.15 ..... **\$5.75 SET** ⚠



**ADPM001 .....ALL**  
 Large washable sponge.  
 Adam's 8.800 -0.15 ..  
**\$11.50 SET** ⚠



**ADPTSPONGE .....ALL**  
 Large washable  
 detail sponge.  
 Adam's 8.800 -0.15  
 ..... **\$2.75 SET** ⚠

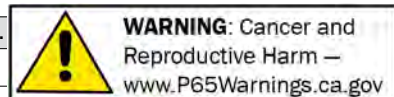

**Towels**

**ADPM0010.....ALL**  
Adam's microfiber glass cleaning towel. Pairs perfectly with Adam's glass cleaner to leave a streak free surface. (2 Pack) -0.15 ..... **\$7.75 EA** ⚠



**ADPM002.....ALL**  
Adams Microfiber Polishing Towel is the softest, safest and most effective polishing towel

on the market. Measuring 16" x 24", the thick yellow towel is ideal for removing polish and Detail Spray. We use two polishing towels for a standard detail. 8.800 -0.15 ..... **\$11.75 EA** ⚠



**ADPM008.....ALL**  
Ultra-soft waffle starfiber jumbo microfiber drying towel. 25" x 36". Adam's

8.800 -0.15 ..... **\$23.50 EA** ⚠

**Water Blade**

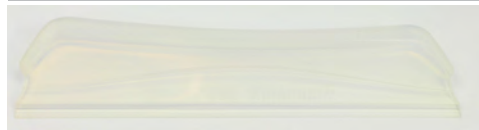

**ALLWB1.....ALL**  
Dry your car in 1/3 the time! The super soft medical grade silicone blade will never scratch your paint. The original California Water Blade. -0.15 ..... **\$12.00 EA** ⚠

**Polishing Ball**



**POWERBALL...ALL**  
Mother's "PowerBall" Use with your favorite polishing compound/ liquid on a drill/ screw gun to revitalize metal, plastic and more. 6"

dia. 8.800 -0.15 ..... **\$32.75 EA** ⚠

**Tire Care**



**91800.....ALL**  
Wide White has been developed specifically to aid in restoring and beautifying wide whitewall tires. This cleaner is safe to use on white rubber and is made from

environmentally friendly ingredients. Restore your sidewalls to snowy white luster. -0 ..... **\$15.00 EA** ⚠

**Duster**



**DUSTER.....ALL**  
California cotton duster w/ plastic handle. 8.800 -0.15 ..... **\$15.95 EA** ⚠



**DUSTERW.....ALL**  
California cotton duster w/ wood handle. 8.800 -0.15 ..... **\$21.75 EA** ⚠

**Car Cover - Flannel**



**306800F.....35-56**  
Flannel. Specify year and model when ordering. 16.550 -0.15 .....starting at **\$216.00 EA** ⚠

**Car Cover - Polycotton**



**306800.....35-56**  
Polycotton. Specify year and model when ordering. 16.550 -0.15 .....starting at **\$185.00 EA** ⚠

**Car Cover - Accessories**



**306800B.....ALL**  
Storage bag. 16.550 -0.15 ..... **\$17.25 EA** ⚠



**306800L.....ALL**  
Lock set. 16.550 -0.15 ..... **\$15.00 EA** ⚠

**Plastic Block**

Scaled engine. Plastic block w/ steel inserts allow you to bolt on actual parts such as valve covers, exhaust headers, front engine pieces, intake and more. Great for engine/ chassis setup, garage display, education, coffee table, etc. Add harmonic balancer to aid in checking front component clearances.



**PAP-200.....ALL**  
Chevy SB, long block w/heads. 0.000 -0 ..... **\$493.75 EA** ⚠



**PAP-201.....ALL**  
Chevy SB, short block. 0.000 -0 ..... **\$410.00 EA** ⚠



**PAP-2041.....ALL**  
Harmonic balancer for Chevy SB. Mount crank pulley for front end clearance. 0.000 -0 ..... **\$105.00 EA** ⚠



**PAP-2120.....ALL**  
Chevy BB, long block w/heads. 0.000 -0 ..... **\$661.25 EA** ⚠



**PAP-2121.....ALL**  
Chevy BB, short block. 0.000 -0 ..... **\$520.00 EA** ⚠

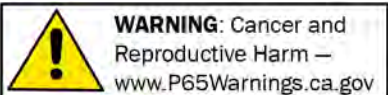

**WARNING: Cancer and Reproductive Harm** — www.P65Warnings.ca.gov

Chemicals shipped domestic ground only (Lower 48 states only). No international shipping.

**Phone: (360) 816-0211 • (800) 999-CHEV (2438) • www.chevsofthe40s.com**

**Plastic Block**



**PAP-2125** .....ALL  
 Harmonic balancer for Chevy BB. Mount crank pulley for front end clearance.  
 0.000 -0 ..... **\$105.00 EA** ⚠

**SECTION 012C  
 STREET ROD PARTS**

**Battery Jump Starter**



**GB40** .....ALL  
 Compact, yet powerful 1,000 Amp lithium-ion jump starter that delivers 7,000 Joules of starting power. Its patented safety technology features spark-proof technology and reverse polarity protection making it safe for anyone to use. Designed for use with gas engines up to 6 liters and diesel engines up to 3 liters and doubles as a portable power source for recharging smartphones, tablets and more. -0.15  
 ..... **\$125.00 EA** ⚠



**GB70** .....ALL  
 The GB70 is a portable lithium-ion battery jump starter pack that delivers 2,000-amps (15,700 J3S) for jump starting a dead battery in seconds. It features a patented safety technology that provides spark-proof connections and reverse polarity protection making safe and easy for anyone to use. It's a powerful battery booster that doubles as a portable power source for recharging USB devices, like a smartphone, tablet and more, or powering 12-volt devices, like a tire inflator, power inverter and much more. And designed for a car, boat, RV, truck and more with gas engines up to 8 liters, and diesel engines up to 6 liters. -0.15 ... **\$250.75 EA** ⚠

**Oil Pad**



**OILPAD** .....ALL  
 Absorbs oil, water, etc. Holds approx 1 gallon (3 ft x 3 ft). 8.821 -0.15 **\$16.50 EA** ⚠

**Oil Pad, cont.**



**OILPAD1** .....ALL  
 Absorbs oil, water, etc. Holds over 1 gallon. (3 ft x 5 ft). 8.821 -0.15 ... **\$22.49 EA** ⚠

**Gas Tank Restoration Kit**



**PORTANK** .....ALL  
 Portank, Restore your tanks. Cleaner, metal prep, sealer (Slosh) and instructions. 3.001 -0.15 .. **\$95.00 KIT** ⚠

**Gas Tank Cleaner**

Works fast & makes petroleum-based cleaners nearly obsolete. Can be diluted with water up to 10 times its volume while remaining potent. Removes grease, oil, mildew, algae, musty odors, soap films & wax. Use it to clean canvas, vinyl, nylon, holding tanks, grease traps, auto parts and more.



**PORCLEAN** ... ALL  
 1 quart.  
**MARINE-CLEAN**  
 cleans and degreases in one application without leaving residues, noxious fumes or flammable solvents.  
 It makes petroleum-

based cleaners almost obsolete because it can be diluted with water up to 3, 4, 5 and even 10 times its volume while remaining more potent than other cleaners. 3.001 -0.15

..... **\$13.25 EA** ⚠

**Fuel Stabilizer**

Keep fuel fresh. Removes water, cleans carburetors & fuel injectors. Protects engine from gum, varnish, rust, and corrosion. Eliminates need to drain fuel before storage. Special dispenser bottles measure exactly without waste. Contains NO alcohol.



**111801** .....ALL  
**STA-BIL** stabilizer. 8 oz bottle treats 20 gallons, for one year. 3.001 -0  
 ..... **\$8.25 EA** ⚠



# Section 012C: Tools, Adhesives & Sealers, Brake Fluid, Gas Tank Prep & Sealer, Carburetor & Brake Cleaners and Polishers

012C

## Fuel Stabilizer, cont.



**111801B .....ALL**  
STA-BIL fuel stabilizer. 32 oz bottle treats 80 gallons, for one year. 3.001 -0.15

**\$21.00 EA** ⚠

## Gas Tank Sealer



**3657942C .....ALL**  
Gas tank sealer slosh, seals gas tank. Alcohol and Ethanol proof. Not for use with (MEK)

Methyl Ethyl Ketone. 3.001 -0.15  
**\$35.25 QT** ⚠

## Metal Prep

Provides adhesion for POR-15 paint (Sect. 15) on aluminum and shiny polished metal surfaces. Etches metal and leaves a zinc phosphate coating. Non-caustic, non-corrosive, non-toxic & non-flammable.



**PORMETAL ....ALL**  
Etches Metal and Leaves a Zinc Phosphate Coating. Provides the best adhesion for POR-15 on any metal surface.

Water based, OSHA approved biodegradable solution. 3.001 -0.15

**\$20.75 QT** ⚠

## Lubricator & Bolt Loosener



**PBBLASTER...ALL**  
Powerful rust inhibitor, bolt loosener/penetrant. -0.3

**\$12.25 EA** ⚠

## Rust Remover



**1001PL .....ALL**  
Rust Remover. Works great, is biodegradable and non-caustic. Our shop loves this product. Great for cleaning inside gas tanks. Sold as a concentrate that

makes 3 gallons. 8.800 -0.15

**\$30.00 EA** ⚠

## Rust Preventer, cont.



**RPM8 .....ALL**  
This is liquid Rust Preventative Magic in an 8 ounce tub. The new wax-like product is easy to apply and will protect bare metal from rusting. It will not reverse rust or remove it, so you will need to sandblast or glass bead any rusty parts clean first. -0.15

**\$35.09 EA** ⚠

## Carburetor Cleaner



**6505259 .....ALL**  
Gumout, 16 oz spray can. Cleans carburetors, linkage, choke valves and unpainted metal parts. 3.725 -0.15

**\$6.50 EA** ⚠

## Brake Cleaner



**6129423 .....ALL**  
Superior cleaner. Many uses (spray can). APPLICATIONS: ABS, disc, drum, brake cylinders, brake drums, brake linings, brake shoes, calipers, clutch discs, disc brake pads, discs. Safe for use on all brake systems including: Springs & Wedge brakes.

4.683 -0.2

**\$4.00 EA** ⚠

## Brake Fluid



**5450285B....ALL**  
Master "Fade Free" DOT 4 (12 oz). 4.683 -0.15

**\$7.00 EA** ⚠

## Brake Fluid, cont.



**603486B.....ALL**  
Mac's, DOT 5, silicone. Less corrosion. 12 ounce bottle. 4.683 -0.15

**\$14.25 EA** ⚠

## Adhesives & Sealers



**01608 .....ALL**  
3M plastic & emblem adhesive (5 oz. tube).

8.800 -0.15

**\$11.25 EA** ⚠



**1015BP .....ALL**  
Gasket sealer, high temp silicone. Black (3.35 oz tube).

8.800 -0.15

**\$12.75 EA** ⚠



**306105 .....ALL**  
Super Glue Gel. Bonds to ABS, Ceramic, cork, G10 Epoxy Glass, Leather and paper. Splice window gaskets & sponge weather strip & more. 8.800 -0.15

**\$3.50 EA** ⚠



**306106 .....ALL**  
LOCTITE Super Glue, Ultra Gel Control. Bonds to Metal, Rubber, Ceramics, Wood, Leather, Paper & Plastics. Rubber to metal & rubber to rubber bonding. Splice

window gaskets & sponge weather strip & more. 8.800 -0.15

**\$6.00 EA** ⚠



**511113 .....ALL**  
Quality Spray adhesive for bowdrill cloth. Best product available for all interior trim. (14 oz. spray can). 8.800 -0.2

**\$16.50 EA** ⚠

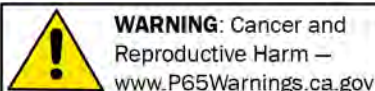

**WARNING: Cancer and Reproductive Harm** —  
www.P65Warnings.ca.gov

Chemicals shipped domestic ground only (Lower 48 states only). No international shipping.

Phone: (360) 816-0211 • (800) 999-CHEV (2438) • www.chevsofthe40s.com

**Section 012C: Tools, Adhesives & Sealers, Brake Fluid, Gas Tank Prep & Sealer, Carburetor & Brake Cleaners and Polishers**

**Adhesives & Sealers, cont.**



**511114.....ALL**  
3M, Black weatherstrip cement, 5-oz tube. Superior product!. 8.800-0.2 .....  
**\$23.75 EA** ⚠



**986199A.....ALL**  
3M Contact cement for rubber to metal. Bonds instantly. Industrial quality for gravel guards, running board rubber, etc. 8.800-0.15

**\$79.50 QT** ⚠  
**GL14.....ALL**  
Windshield sealer. Seals leaks in new & old installation. Will not dry out rubber. Remains pliable. 8.991-0.15 .....  
**\$13.00 EA** ⚠



**Adhesive Remover**



**3M8987.....ALL**  
Specially blended solvent for removal of light paint overspray, adhesive residue, wax, grease, tree sap, dirt, road tar, oil and bugs in aerosol form. -0.15 .....  
**\$19.75 EA** ⚠

**Safety Wire Pliers**



**R809.....ALL**  
Safety Wire Pliers - 9". -0.15 .....  
**\$39.75 EA** ⚠

**Interior Tools**



**3703632C.....39-48**  
Removes horseshoe clips-interior handle 10.511-0.3 .....  
**\$17.00 EA** ⚠



**3703632A.....49-57**  
Removes horseshoe clips-interior handle. 10.511-0.2 .....  
**\$5.75 EA** ⚠

**SECTION 012C RESTORATION PARTS**

**TOOL7672.....ALL**  
Headliner installation tool, economy version. Used for pushing material into tight corners or channels. -0.15 .....  
**\$13.75 EA** ⚠

**Tools**



**4088134A....ALL**  
Installs door handle ferrules. Return tool in same condition as sent for a \$20 refund. Does not fit with 4125630 10.537-0.15 .....  
**\$50.25 EA** ⚠

**Clutch Head Driver W/ Bits**



**DRIVER.....ALL**  
Magnetic clutch head driver, Chev's imprint. w/ 5 bits (1/8 in., 5/32 in., 3/16 in., 1/4 in., 5/16 in.) 8.821-0.15 .....  
**\$22.25 SET** ⚠

**Clutch Head Bits**

- 3685592.....ALL**  
Clutch head bit 5/32 in. (1/4 in. drive) 8.821-0.4 .....  
**\$5.00 EA** ⚠
- 3685593.....ALL**  
Clutch head bit 1/4 (1/4 in. drive) 8.821-0.4 .....  
**\$4.75 EA** ⚠
- 3685594.....ALL**  
Clutch head bit 3/16 in. (1/4 in. drive) 8.821-0.3 .....  
**\$2.75 EA** ⚠
- 3685595.....ALL**  
Clutch head bit 5/16 in. (1/4 in. drive) 8.821-0.2 .....  
**\$8.50 EA** ⚠
- 3685598.....ALL**  
Clutch head bit 1/8 in. (1/4 in. drive) 8.821-0.15 .....  
**\$2.50 EA** ⚠

**Clutch Bit Holder**



**3685596.....ALL**  
Clutch bit holder for your 1/4 in. drive ratchet. Holds clutch head bits. 8.821-0.2 .....  
**\$7.00 EA** ⚠

**Tool Bag**



**986362.....ALL**  
Tool bag. Superb reproduction w/ pictures of tools which may be found at swap meets. 13-5/8" x 6". 8.821-0.15 .....  
**\$29.00 EA** ⚠

**Engine, Drivetrain Tools**



**38352226.....37-53**  
Tool used to align oil dipper troughs in pan (\$375 refundable deposit upon return of tool) 1.427-0.15 .....starting at **\$477.00 Rent** ⚠



**595005A.....37-54**  
Drive shaft bushing puller to rent (return in original condition for \$20.00 refund). 5.451-0.15 .....  
**\$95.00 EA** ⚠



**J14505.....39**  
Vacuum shift adjustment tool w/ instructions. 4.045-0.2 .....  
**\$12.50 EA** ⚠



**J14525.....40-48**  
Vacuum shift adjustment tool w/ instructions. 4.045-0.4 .....  
**\$8.00 EA** ⚠



**838956A.....ALL**  
Tool to align clutch disc. 0.866-0.3 .....  
**\$12.25 EA** ⚠





**Body Tools**



**017531A.....40-48**  
Hood spring installation & removal tool w/ instructions. 8.015 -0.15 ... **\$65.75 EA** ⚠



**3847415T.....42-54**  
Inserts back glass rubber lock strip. 16.469 -0.3 ... **\$61.00 EA** ⚠



**017531.....49-54**  
Hood spring installation & removal tool w/ instructions. 8.015 -0.15 ... **\$78.25 SET** ⚠



**4601061T.....53-58**  
Removes chrome wiper transmission nut 10.160 -0.15 ... **\$15.50 EA** ⚠



**010351.....ALL**  
Removes mouldings (Amazing!) 8.821 -0.15 ... **\$20.50 EA** ⚠



**01832.....ALL**  
To install windshield & back window rubber (exc 41-48 w/ mouldings) 8.821 -0.15 ... **\$18.75 EA** ⚠



**WELDCLAMP.....ALL**  
Aligns panels together for precise butt welds -0.15 ... **\$23.50 SET** ⚠

**Genius Battery Chargers**



**GENIUS10.....ALL**  
most powerful, highest-performing, energy-efficient, and compact chargers yet. The

GENIUS5 is a 6-volt and 12-volt battery charger, battery maintainer, and battery desulfator rated at 10-amps for lead-acid automotive, marine, and deep-cycle batteries, including flooded, gel, AGM, and maintenance-free, plus lithium-ion batteries. -0 ... **\$125.00 EA** ⚠

**GENIUS2.....ALL**  
most powerful, highest-performing, energy-efficient, and compact chargers yet. The GENIUS2 is a 6-volt and 12-volt battery charger, battery maintainer, and battery desulfator rated at 2-amps for lead-acid automotive, marine, and deep-cycle batteries, including flooded, gel, AGM, and maintenance-free, plus lithium-ion batteries. -0 ... **\$65.00 EA** ⚠

**GENIUS5.....ALL**  
most powerful, highest-performing, energy-efficient, and compact chargers yet. The GENIUS5 is a 6-volt and 12-volt battery charger, battery maintainer, and battery desulfator rated at 5-amps for lead-acid automotive, marine, and deep-cycle batteries, including flooded, gel, AGM, and maintenance-free, plus lithium-ion batteries. -0 ... **\$90.00 EA** ⚠

**Battery Terminal Cleaner**



**10653CLNR .. ALL**  
Battery top post cleaner -0.15 ... **\$12.00 EA** ⚠

**Basic Auto Electricity Book**

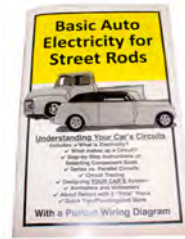

**WASBAEB .... ALL**  
Contains sections on: What is Electricity? Covers the battery, alternator, voltage regulator, grounding and fuses, designing a simple circuit & more including.

Circuit Diagram, Ammeter and Volt Meter usage. A full 48 pages plus Fold out Circuit Diagram and 8-1/2" x 14" Pullout Wiring Diagram to remove and customize to match your own car's circuits. 0.000 -0.15

..... **\$11.75 EA** ⚠

**Lubricator & Bolt Loosener**



**511115.....ALL**  
Graphite lubricant for your speedometer cable, .5 oz tube. -0.15 ... **\$5.00 EA** ⚠

**Stainless Steel Tubing**



**SSTUBING.....ALL**  
304 seamless tubing in 1/2", 5/8" & 3/4" O.D. Can be cut to length. Total lengths up to 20 ft sticks (oversize shipping on long lengths). -0 ... starting at **\$10.00 FT** ⚠

**Interior Tools**



**4173376A.....49-65**  
Sets vent window pivot pin. 10.669 -0.15

**\$5.00 EA** ⚠  
**ALLHRDR.....ALL**  
1-1/4" wide with black painted hardwood handle, roller tool for applying sound deadening. -0.15 ... **\$23.00 EA** ⚠



**TOOL13575.....ALL**  
Headliner installation tool, -0.15 ... **\$35.75 EA** ⚠

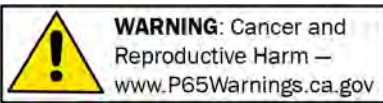

Chemicals shipped domestic ground only (Lower 48 states only). No international shipping.

**Phone: (360) 816-0211 • (800) 999-CHEV (2438) • www.chevsofthe40s.com**



**SECTION 015C  
STREET ROD PARTS**

**POR-15 Rust Preventative Paint**



**POR-15QT . . . . .ALL**  
1 quart. POR-15 Rust-preventative coating applied directly over rusted or seasoned metal surfaces. Dries as rock hard, nonporous finish that won't chip, crack or peel. Prevents rust from reoccurring. Choose Black, Semi-Gloss Black, Grey, Silver or Clear.

8.800 -0.15 . . . . . **\$48.50 QT** ⚠

**Sound Deadener Thermal Protection**



**DEADENER . . . . .ALL**  
Engineered for the interior & exterior side of body panels. 200% decrease in noise & vibration. Bonds to metal, fiberglass & wood. Covers 30 sq. ft. 8.800 -0.15 . . .

**\$85.00 GALLON** ⚠



**SPRAYGUN . . . . .ALL**  
Spray gun. Siphon-feed spray gun for DEADENER. 8.800 -0.15 . . . . . **\$89.50 EA** ⚠



**VB-1SPRO . . . . .ALL**  
For exterior automotive panels such as inside fender wells, wheel arches and underside

of the floor pan. Converts structural resonance and vibration into low level heat through friction. It remains soft which allows it to absorb the impact of road debris. (NOTE: Only apply to exterior surfaces due to prolonged outgassing). 18 oz. aerosol can. Covers 4 sq. ft. 8.800 -0.15 . . . . . **\$14.50 EA** ⚠

**Zero Rust Paint**



**511112C . . . . .ALL**  
Satin black w/ rust inhibitors. Use on core supports, inner fender panels, etc. (12 oz. spray). Match to GM satin black.

8.800 -0.15 . . . . . **\$23.25 EA** ⚠

**POR-15 Rust Paint Solvent**



**POR-15QTSLV . . . . .ALL**  
Thinner. Use for easy cleanup or thinning of POR-15 paint. 8.800 -0.15 . . . . . **\$15.75 QT** ⚠

**Hi Temp Engine Paint**



**986959B . . . . .ALL**  
VHT Hi-Temp Gloss Black Engine enamel (11 oz. spray can). 8.800 -0.15 . . . . . **\$18.00 EA**



**986959FB . . . . .ALL**  
VHT Hi-Temp Flat Black Engine enamel (11 oz. spray can). 8.800 -0.15 . . . . . **\$17.00 EA** ⚠



**9869590 . . . . .ALL**  
VHT Hi-Temp Chevy Orange enamel (12 oz. spray can). 8.800 -0.15 . . . . . **\$12.75 EA** ⚠



**986959R . . . . .ALL**  
VHT Hi-Temp Universal Red Engine enamel (11 oz. spray can). 8.800 -0.15 . . . . . **\$14.00 EA**



**986959SB . . . . .ALL**  
VHT Hi-Temp Chevy GM Satin Black Engine enamel (11 oz. spray can). 8.800 -0.15 . . . . . **\$17.50 EA** ⚠

**\$17.50 EA** ⚠



**986959UA . . . . .ALL**  
VHT Hi-Temp Universal Aluminum Engine enamel (11 oz. spray can). 8.800 -0.15 . . . . . **\$14.50 EA** ⚠

**\$14.50 EA** ⚠

**Cast Blast Paint**



**3657963D . . . . .ALL**  
Cast blast paint high temp 1200 degree. Grey, fresh cast look for exhaust manifolds, etc. Rust preventative, 11 oz spray can. 3.609 -0.15 . . . . . **\$18.00 EA** ⚠

**\$18.00 EA** ⚠



**3657963F . . . . .ALL**  
Grey cast color paint, For non high heat applications. Gives fresh cast look. Rust preventative, 11 oz spray can. 3.609 -0.15 . . . . . **\$6.75 EA** ⚠

**\$6.75 EA** ⚠

**Inner Fender Panel Paint**



**511112D . . . . .ALL**  
Semi-flat black spray paint for use on core supports and inner fender panels. 8.800 -0.15 . . . . . **\$15.50 EA** ⚠

**\$15.50 EA** ⚠

**SECTION 015C  
RESTORATION PARTS**

**Cab Interior Paint**



**604481P . . . . .40-46**  
Beige hammertone-for cab interior (thin w/ enamel thinner) 16.080 -0.15 . . . . .

**\$110.00 QT** ⚠



**3693291P . . . . .47-53**  
Semi flat brown, slight metallic for cab interior. Acrylic enamel (thin w/ enamel thinner). 16.080 -0.15 . . . . . **\$42.00 QT** ⚠

**\$42.00 QT** ⚠



**3700359P . . . . .47-54**  
Pulsar grey, for cab interior, 47-54 Panel & Suburban 54 deluxe cab, interior enamel 16.080 -0.15 . . . . . **\$60.50 QT** ⚠

**\$60.50 QT** ⚠



**985734S . . . . .54**  
Pearl beige for interior of cab. 16.080 -0.15 . . . . . **\$60.50 QT** ⚠

**Clear Coat Paint**



**10200Z . . . . .ALL**  
Gloss Clear Coat For Bare Metal Surfaces. Great for use on polished metal to keep the shine. 8.800 -0.15 . . . . . **\$17.25 EA** ⚠

**Engine Paint**



**986959A . . . . .29-52**  
Engine Grey. Reduce using Xylene (max of 15%). 8.800 -0.15 . . . . . **\$43.25 QT** ⚠

**\$43.25 QT** ⚠



**986959S . . . . .29-52**  
Chevy Engine Grey hi-temp (16 oz. spray can). Color has been tested and is correct. 8.800 -0.15 . . . . . **\$27.75 EA** ⚠

**\$27.75 EA** ⚠



**986970G . . . . .37-46**  
Engine (olive) GMC 8.800 -0.15 . . . . . **\$56.75 QT** ⚠

**\$56.75 QT** ⚠



**986970M . . . . .47-59**  
Engine (red orange) GMC 8.800 -0.15 . . . . . **\$63.75 QT** ⚠

**\$63.75 QT** ⚠



**986970A . . . . .53-62**  
Engine Blue 8.800 -0.15 . . . . . **\$56.75 QT** ⚠

**\$56.75 QT** ⚠

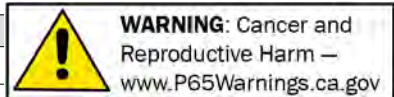

**Engine Paint, cont.**



**986970S.....53-62**  
Chevy Engine Blue  
(12-3/4 oz. spray can).  
8.800 -0.15 **\$27.50 EA**



**Hi Temp Engine Paint**

**986959SL .....ALL**  
Dupli-Color Silver High Temp Paint With  
Ceramic (12 oz Can) 8.800 -0 .....  
**\$14.00 EA**

**Carburetor Paint**



**12910 .....ALL**  
Carburetor renew,  
bronze (5 oz. spray  
can). Fuel and additive  
resistant 8.800 -0 .....

**CALL**

**Dash Bottom And Steering Column  
Paint**



**4115190A ..... 41**  
Tan w/ pink cast. For  
dash bottom & steering  
column. Special Deluxe,  
quart.

The manufacturer suggests a reduction of  
8:1 to 4:1, no hardener is necessary.

10.232 -0 ..... **\$81.25 QT**



**4115190B ..... 41**  
Tan w/ pink cast for  
dash bottom & steering  
column. Special Deluxe.  
12 oz spray 10.232 -0.15  
..... **\$25.00 EA**

**Battery Tray Paint**



**12998 .....ALL**  
Battery tray Corrosion  
resistant, black (12 oz  
spray). 8.800 -0.15 .....  
**\$15.00 EA**

**Heater Paint**



**604481P.....42-46**  
Heater beige  
hammer tone (thin w/  
enamel thinner).  
16.080 -0.15 .....

**\$110.00 QT**

**Exhaust Paint**



**3657963C .....ALL**  
Exhaust paint stainless  
steel pigments. For  
exhaust manifolds &  
pipes. Gives a soft grey,

metallic finish. Pint 3.609 -0 ... **CALL**



**3657963E.....ALL**  
Exhaust paint clear,  
high temp (1200  
degree) for exhaust etc,  
11 oz spray can.

3.609 -0.15 ..... **\$21.25 EA**



**3657963FA.....ALL**  
Exhaust paint very high  
temp, flat aluminum for  
manifolds & pipes. 11  
oz spray can. 3.609 -0

..... **\$19.00 EA**

**Inner Fender Panel Paint**



**511112.....ALL**  
Zero Rust Inner fender  
panel satin black-also  
great for core supports.  
(quart) 8.800 -0.15 .....

**\$40.00 QT**

**Hub Caps And Trim Paint**



**306505.....ALL**  
Black, for hub caps &  
trim (special lettering  
enamel) 1/2 pint  
8.800 -0.15 **\$34.25 EA**



**306553.....ALL**  
Blue, for hub caps &  
trim (special lettering  
enamel). 1/2 pint.  
8.800 -0.15 **\$38.25 EA**



**306567.....ALL**  
Red, for hub caps &  
trim (special lettering  
enamel) 1/2 pint  
8.800 -0.15 **\$46.00 EA**

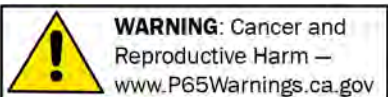

Chemicals shipped domestic ground only (Lower 48 states only). No international shipping.

**Phone: (360) 816-0211 • (800) 999-CHEV (2438) • www.chevsofthe40s.com**

# Section 020C: Engine Kits

| Model Year | 216 CU INCH ID NUMBERS<br>(stamped in block above starter) | BLOCK NUMBERS    |
|------------|--|------------------|
| 37         | 1 to 1187821   | 838101<br>838710 |
| 38         | 1187822 – 1915446<br>& B1 – B10502                         | 838710           |
| 39         | 1915447 – 2697267<br>& B10503 – B105461                    | 838941           |
| 40         | 2697268 – 3665902<br>& B105462 – B221935                   | 839132           |
| 41         | AA 1001 – AA 1163720<br>& AC 1001 – AC 19549               | 839400           |

| Model Year | 216 CU INCH ID PREFIXES<br>(stamped in block above starter)  | BLOCK NUMBERS |
|------------|--|---------------|
| 42         | 2AA, 2AC, BA   | 839770        |
| 46         | DA   | 839770        |
| 47         | EA   | 839770        |
| 48         | FA   | 3835253       |
| 49         | GA   | 3835253       |
| 50         | AHCA, AHCM, BHCA, BHCM, HAA,<br>HAM, HAC, HAP, HBA, HBM, HCA, HCM,<br>HCD, HCQ                     | 3835497       |
| 51         | AJCA, AJCM, BJCA, BJCM, JAA, JAM,<br>JAC, JAP, JBA, JBM, JCA, JCM, JCD, JCQ                        | 3835497       |
| 52         | AKCA, AKCM, BKCA, BKCM, KAA,<br>KAM, KAC, KAP, KBA, KBM, KCA, KCM,<br>KCD, KCQ                     | 3835849       |
| 53         | ALLC, ALCP, BLCC, BLCP, LAG, LAT, LAJ,<br>LAV, LBA, LBM, LCA, LCM, LCC, LCP,<br>LCD, LCQ, LCH, LCU | 3835849       |

Numbers are listed here as a guide only.  
Your assistance in updating this list is appreciated!

| Model Year | 235 CU INCH ID NUMBERS<br>(stamped in block above starter)   | BLOCK NUMBERS      |
|------------|--|--------------------|
| 41         | AG, AL   | 3660439            |
| 42         | BG, BL   | 839751             |
| 46         | BG, BL – 1ST DESIGN  | 839751             |
| 46         | DDA, DDM, DEA, DEM – 2ND DESIGN  | 839751             |
| 47         | EDA, EDM, EEA, EEM   | 3835335            |
| 48         | FDA, FDM, FEA, FEM   | 3835309            |
| 49         | GDA, GDM, GEA, GEM   | 3835309            |
| 50         | HDA, HDM, HEA, HEM   | 2692703            |
| 51         | JDA, JDM, JEA, JEM   | 2692703            |
| 52         | KDA, KDM, KEA, KEM   | 3835692            |
| 53         | LDA, LDM, LEA, LEM, LAA  | 3701946<br>3701483 |
| 54         | T54 OR F54 followed by:<br>L, LA, M, MA, MB, N, P, Q, R, S, T, TA, U,<br>UA, UB, X, XZ, XB, Y, YE, YG, Z, ZC, ZE, ZH | 3701481            |
| 54         | EXCEPT 53 ST   | 3701481            |
| 54         | FIRST SERIES   | 3733949            |
| 55         | THROUGH 4/1/56   | 3836233            |

| Model Year | 261 CU INCH ID PREFIXES | BLOCK NUMBERS      |
|------------|-------------------------|--------------------|
| 54-55      | FIRST SERIES            | 3702436<br>3703414 |
| 56         | ALL                     | 3836340            |
| 57         | ALL                     | 3836340            |
| 55-57      | ALL                     | 3836340            |
| 58         | ALL                     | 3836340            |
| 59         | ALL                     | 3759365            |
| 60-62      | ALL                     | 3769923            |

## ENGINE CAMSHAFT, CRANKSHAFT AND OIL PAN

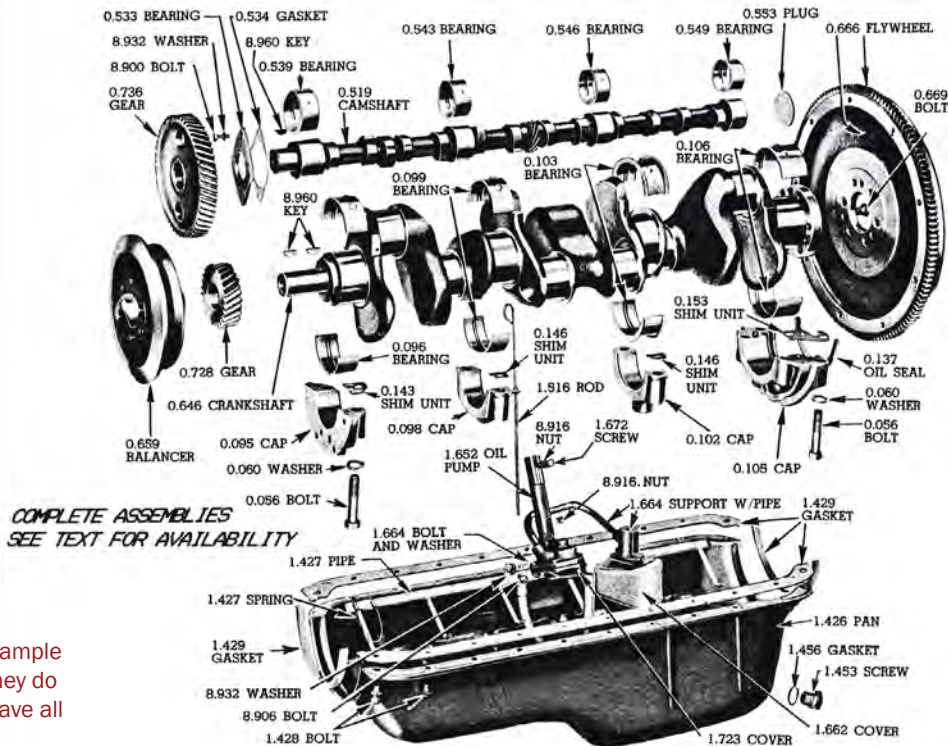

Illustrations are for example and reference only. They do not indicate that we have all the parts shown.

Returns require a return authorization number—call first. • Product pricing & availability subject to change.



**WARNING:** Cancer and Reproductive Harm —  
www.P65Warnings.ca.gov





**SECTION 020C  
RESTORATION PARTS**

Oversize shipping charges apply. Please call for rate.

**Engine Kit**

When ordering: SPECIFY exact year and size of engine (216ci, 235ci or 261ci), HYDRAULIC or solid lifters, standard or exact oversize of rod, main bearings, pistons and rings. Also SPECIFY stick shift or powerglide.

Call for availability of pistons & bearings before boring block or having crank turned.

**MEK1 Engine Kit**

MEK1 contains all parts necessary to overhaul a complete short block assembly. Including: Rods machined for insert bearings, rod bearings, main bearings, pistons with pins, piston rings, new camshaft, lifters, cam bearings, timing gears, full gasket set, soft plugs, plastiguage, oil pump, bolt boots & block sealant lube (1937-39 includes pushrods). \*Assembly lube no longer included.

- MEK139** ..... **37-39**
- 216. Includes pushrods, does not include oil pump 0.001 -0.15 ..... **\$1,800.00 KIT** ⚠
- MEK140** ..... **40**
- 216 0.001 -0.15 ..... **\$2,025.00 KIT** ⚠
- MEK147** ..... **41-47**
- 216 0.001 -0.15 ..... **\$1,845.00 KIT** ⚠
- MEK153** ..... **48-53**
- 216 0.001 -0 ..... **\$1,475.00 KIT** ⚠
- MEK152** ..... **50-52**
- 235. For Powerglide. Car only. 0.001 -0 ..... **\$1,600.00 KIT** ⚠
- MEK162** ..... **53-62**
- 235. Except 53 stick 0.001 -0 ..... **\$1,300.00 KIT** ⚠

**EK Engine Kit**

EK contents are same as MEK1 except w/ out pistons/rings & converted rods.

- EK39** ..... **37-39**
- Includes pushrods 0.001 -0.15 ..... **\$750.00 KIT** ⚠
- EK47** ..... **40-47**

The kit contains:

- Rod bearings (specify size)
- Cam bearings
- camshaft
- Lifters
- Timing gears
- Full gasket set
- Soft plug set
- Plastiguage (used to measure bearing tolerances)
- Bolt boots (go on rod bolts to protect crank) 0.001 -0.15 ..... **\$825.00 KIT** ⚠
- EK53** ..... **48-53**
- Except 53 Powerglide 0.001 -0 ..... **\$895.00 KIT** ⚠

**EK Engine Kit, cont.**

- EK62** ..... **53-62**
- Except 53 stick 0.001 -0.15 ..... **\$675.00 KIT** ⚠
- EK58** ..... **54-58**
- For solid lifter 261ci 0.001 -0.15 ..... **\$715.00 KIT** ⚠

**RRK Re-Ring Kit**

RRK contains: Rod bearings, piston rings, full gasket set, plastiguage, assembly lube & bolt boots.

- RRK39** ..... **37-39**
- Piston re-ring kit (RRK) that includes: Full gasket set
- Rod bearings (choose size, std. to .060)
- Piston rings (choose size)
- Bolt boots for rod installation (protect crank)
- Plastiguage (for measuring bearing tolerances)
- Assembly Lube 0.001 -0.15 ..... **\$625.00 KIT** ⚠
- RRK53** ..... **40-53**
- Except 53 Powerglide 0.001 -0.4 ..... **\$625.00 KIT** ⚠
- RRK62** ..... **53-62**
- Except 53 stick 0.001 -0.3 ..... **\$625.00 KIT** ⚠

**RRK3 (Re-Ring Kit W/ Main Bearings)**

RRK3 contents are same as RRK except main bearings are included.

- RRK339** ..... **37-39**
- Includes: Full gasket set
- Rod bearings (choose size)
- Main bearings (choose size)
- Piston rings (choose size)
- Bolt boots for rod installation (protect crank)
- Plastiguage (for measuring bearing tolerances)
- Assembly Lube 0.001 -0.4 ..... **\$625.00 KIT** ⚠
- RRK347** ..... **40-47**
- Includes: Full gasket set
- Rod bearings (choose size)
- Main bearings (choose size)
- Piston rings (choose size)
- Bolt boots for rod installation (protect crank)
- Plastiguage (for measuring bearing tolerances)
- Assembly Lube 0.001 -0.4 ..... **\$625.00 KIT** ⚠
- RRK353** ..... **48-53**
- Except 53 Powerglide 0.001 -0.4 ..... **\$625.00 KIT** ⚠
- RRK362** ..... **53-62**
- Except 53 stick 0.001 -0.4 ..... **\$625.00 KIT** ⚠

**CLK (Cam & Lifter Kit)**

CLK contains: Reground camshaft, lifters & timing cover gasket set.

- CLK39** ..... **37-39**
- Solid lifter w/ pushrods 0.001 -0.3 ... **\$525.00 KIT** ⚠
- CLK53** ..... **40-53**
- Solid lifter exc 53 Powerglide 0.001 -0.15 ..... **\$315.00 KIT** ⚠
- CLK62** ..... **53-62**
- Hydraulic lifter exc 53 stick 0.001 -0.15 ..... **\$360.00 KIT** ⚠
- CLK58** ..... **54-58**
- Solid lifter. 0.001 -0.15 .. **\$549.00 KIT** ⚠

**CLK3 (Cam, Lifter Kit & Timing Gears)**

CLK3 contents are the same as CLK except timing gears are included.

- CLK339** ..... **37-39**
- Solid lifter w/ pushrods 0.001 -0.15 .. **\$425.00 KIT** ⚠
- CLK353** ..... **40-53**
- Solid lifter exc 53 Powerglide 0.001 -0 ..... **\$450.00 KIT** ⚠
- CLK362** ..... **53-62**
- Hydraulic lifter exc 53 stick 0.001 -0.15 ..... **\$425.00 KIT** ⚠
- CLK358** ..... **54-58**
- Solid lifter. 0.001 -0.15 .. **\$671.75 KIT** ⚠

**PRK (Piston & Ring Kit)**

PRK contains: Pistons with pins and piston rings.

- PRK40** ..... **37-40**
- Domed piston 0.001 -0.15 ..... **\$341.00 KIT** ⚠
- PRK53** ..... **41-53**
- 216ci 0.001 -0.15 .... **\$312.00 KIT** ⚠
- PRK62** ..... **41-62**
- 235ci (exc 53 Powerglide) 0.001 -0.15 ..... **\$288.00 KIT** ⚠
- PRK61** ..... **54-62**
- 261ci 0.001 -0.15 .... **\$353.00 KIT** ⚠

Returns require a return authorization number—call first. • Product pricing & availability subject to change.

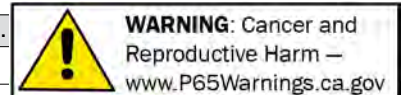



**SECTION 022C  
RESTORATION PARTS**

Note: Pilot bearing bushing see Section 140C.  
Note: Engine electrical see Section 40C, 45C & 50C.

Note: Fuel pump & carburetor see Section 120C.

Note: Price subject to bearing availability.  
Before grinding crank shaft, please contact us to be sure undersize bearings needed are available.

**Valve And Rocker Cover Set**



**3836614S** .....50-62  
235ci chromed side cover & valve cover w/ breather cap and gaskets. Excellent finish. 0.386 -0 ..... **\$116.00 SET** ⚠

**Side Covers Chevy Six Cylinder**



**3701541F** .....50-62  
Finned plain aluminum side cover. Fits 235ci-261ci. 0.439 -0 .. **\$259.50 EA** ⚠



**3701541FP** .....50-62  
Finned polished aluminum side cover. Fits 235ci-261ci. 0.439 -0 .. **\$329.75 EA** ⚠

**37015410F** .....50-62  
Offenhauser Finned polished aluminum side cover. Fits 235ci-261ci. -0 ..... **\$399.25 EA** ⚠



**3701541W** .....50-62  
"Wayne" Finned aluminum side cover. Superb reproduction, fits 235ci-261ci. 0.439 -0.15 ..... **\$350.00 EA** ⚠



**R9108** .....ALL  
Chrome 1950-62 Chevy 235 6-cyl Side Plate. -0.15 ..... **\$61.75 EA** ⚠

**Valve Cover Chevy Six Cylinder**



**3686784C** .....37-53  
Chrome 1937-53 Chevy 216 6-cyl Valve Cover - Unbaffled. -0.15 .. **\$86.00 EA** ⚠



**R9107** .....50-62  
Chrome 1950-62 Chevy 235 6-cyl Valve Cover - Unbaffled. -0.15 .. **\$76.50 EA** ⚠

**Finned Valve Cover**



**3686784F** .....37-62  
Finned aluminum valve cover for 216 & 235. -0 ..... **\$349.75 EA** ⚠



**3686784FP** .....37-62  
Finned polished aluminum valve cover for 216 & 235. -0 ..... **\$480.00 EA** ⚠

**Offenhauser Valve Cover**



**38366140** .....37-62  
Offenhauser Ribbed for 235ci. Polished aluminum valve cover. 0.386 -0.15 ..... **\$427.00 EA** ⚠

**Wayne Valve Cover**



**3686784W** .....37-62  
"Wayne" Finned aluminum cover. Superb reproduction. 0.386 -0.15 .. **\$399.00 EA** ⚠

**Valve Cover Hardware**



**838083B** .....37-62  
Studs, washers & nuts for Wayne or Offy valve cover 0.413 -0.15 ... **\$38.00 SET** ⚠

**8380830TB** .....37-62  
Studs, washers & acorn nuts for OTB valve cover 0.413 -0 ..... **\$45.25 SET** ⚠

**Valve Cover Grommets**



**838083** .....34-53  
2 pcs 0.413 -0.15 ... **\$6.00 PR** ⚠

**Valve Cover Acorn Nut**



**131502** .....29-53  
Stainless 8.915 -0.3 ..... **\$9.00 PR** ⚠



**131502C** .....29-53  
Chrome 8.915 -0.15 ..... **\$6.50 PR** ⚠



**131502P** .....29-53  
Polished stainless 8.915 -0.15 ..... **\$28.25 PR** ⚠

**Valve Cover Breather**



**OTB-6810FP** ....37-62  
Finned Polished Aluminum 90 Degree Mount -0 ..... **\$109.25 EA** ⚠



**OTB-6811F** ....37-62  
Finned Aluminum 90 Degree Mount -0 ..... **\$89.00 EA** ⚠



**OTB-6801** .....ALL  
Finned polished aluminum. 1" dia. neck for 1-1/4" hole using a rubber grommet. -0.15 ..... **\$65.25 EA** ⚠

**Oil Fill Cap**



**OTB-6152FP** ....37-62  
Finned Polished Aluminum Oil Cap 2-5/8" Dia 1" Tall -0 ..... **\$45.25 EA** ⚠



**OTB-6153F** ....37-62  
Finned Aluminum Oil Cap 2-5/8" Dia 1" Tall -0 ..... **\$35.25 EA** ⚠



**3835665** .....46-57  
Breather on rocker cover, replacement. 0.386 -0.3 ..... **\$12.00 EA** ⚠

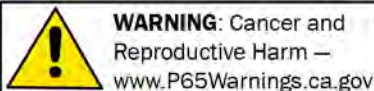

Chemicals shipped domestic ground only (Lower 48 states only). No international shipping.

**Phone: (360) 816-0211 • (800) 999-CHEV (2438) • www.chevsofthe40s.com**



**Oil Fill Cap, cont.**



**6150SP.....ALL**  
Valve cover Sprocket  
Polished Oil Cap  
Polished Diameter - 3".  
Height - 1-1/8". -0

**\$55.00 EA** ⚠



**6151S.....ALL**  
Valve cover Sprocket  
Unpolished Oil Cap  
Polished Diameter - 3".  
Height - 1-1/8". -0

**\$45.00 EA** ⚠

**Pistons**



**602806.....37-40**  
Fits 216 Specify oversize (6 pcs) 0.629-0.15  
..... starting at **\$296.00 SET** ⚠

**605260.....41-53**  
Fits 216 Specify oversize (6 pcs)  
0.629-0.15 ..... starting at **\$267.00 SET** ⚠

**369398.....41-62**  
Fits 235 Specify oversize (6 pcs)  
0.629-0.15 ..... starting at **\$228.00 SET** ⚠

**3707460.....54-62**  
Fits 261 Specify oversize (6 pcs)  
0.629-0.15 ..... starting at **\$288.00 SET** ⚠

**Rings**



**608021.....37-53**  
Fit 216ci (specify oversize) 0.643-0.15  
..... starting at **\$45.00 SET** ⚠

**370405.....41-53**  
235ci exc 53 Powerglide (specify  
oversize) 0.643-0.15 ..... starting  
at **\$60.00 SET** ⚠

**370527.....53-54**  
235ci exc 53 stick (specify oversize)  
0.643-0.2 ..... starting at **\$60.00 SET** ⚠

**3720210.....54-62**  
261ci (specify oversize) 0.643-0.15 ...  
starting at **\$65.00 SET** ⚠

**Wrist Pins**



**838570.....37-62**  
Standard 0.636-0.15  
..... **\$4.75 EA** ⚠

**Plastigauge**



**609118P.....ALL**  
To check bearing clearance. 0.143-0.15  
..... **\$7.75 EA** ⚠

**Main Bearings And Shims**



**384706.....37-39**  
Standard to .075 under. 0.099-0.15 ..  
starting at **\$250.00 SET** ⚠

**384206.....40-47**  
Standard size to .075 under. 0.099-0.15  
..... starting at **\$251.00 SET** ⚠



**609118B.....40-53**  
Shims for main bearings. 0.143-0.15 ..  
**\$58.50 SET** ⚠

**368847.....48-53**  
Standard, .002, .010, .020, .030 exc 53  
Powerglide. 0.099-0.15 ..... starting  
at **\$210.00 SET** ⚠

**368855.....48-53**  
.040, .050, .060 (exc 53 Powerglide).  
0.099-0.15 ..... starting at **\$130.00 SET** ⚠

**370394.....53-62**  
Standard to .040 exc 53 stick. 0.099-0.15  
..... starting at **\$106.00 SET** ⚠

**Rod Bearings And Shims**



**3692517.....29-53**  
.009 thick shims for  
bearings. 12 per set.  
0.619-0.15 ..... **\$50.50 SET** ⚠



**370485.....37-53**  
Standard size to .060. (exc '53  
Powerglide). 0.616-0.15 ..... starting  
at **\$200.00 SET** ⚠

**370486.....53-62**  
Except 53 stick 0.616-0.15 ..... starting  
at **\$154.00 SET** ⚠

**Rod Service**



**602235A.....37-53**  
Send in your rods and we will machine  
them for insert bearings. 0.603-0 **CALL**  
⚠

**Rod**

Note: SPECIFY exact model engine with rod  
casting number when possible. \$35 core  
charge refundable on rebuildable rod.

**602235N.....37-47**  
Babbitt rods. Standard size only (NOS).  
0.603-0.4 ..... **\$54.00 EA** ⚠

**Rod Bolt And Nut**



**3835449.....33-53**  
Except 53 Powerglide  
0.623-0.15 **\$5.50 EA**  
⚠



**107823.....ALL**  
Pal lock nuts for rod  
bolts 0.626-0.4 ....  
**\$11.00 SET** ⚠

**Rod Dipper**



**3834884.....33-53**  
Used. For connecting  
rod. 0.604-0.15 .....  
**\$4.99 EA** ⚠

**Rod Bolt Boots**



**986047B.....ALL**  
Protects crankshaft  
during assembly  
8.800-0.15 ..... **\$2.75 PR** ⚠

**Valve Seats**



**3688065A.....38-52**  
Intake exc 50-52 235ci 0.296-0.2  
..... **\$6.75 EA** ⚠

**3835318A.....38-52**  
Exhaust exc 50-52 235ci 0.297-0.2 ..  
..... **\$6.75 EA** ⚠

**3683569A.....50-52**  
Exhaust 235ci 0.297-0.15 ..... **\$12.75 EA**  
⚠

**3835519A.....50-62**  
Intake 235ci 0.296-0.3 .. **\$6.75 EA** ⚠

**3683569B.....53-62**  
Exhaust 235ci 0.297-0.15 ... **\$5.00 EA**  
⚠

**Valve Guide**

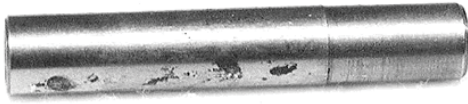

- 3688758** ..... **38-40**
- Intake 0.283 -0.15 ..... **\$6.50 EA** ⚠
- 3688759** ..... **38-40**
- Exhaust 0.283 -0.15 ..... **\$7.50 EA** ⚠
- 3688761** ..... **41-62**
- Exhaust 0.283 -0.15 ..... **\$7.25 EA** ⚠
- 3708168** ..... **41-62**
- Intake 0.283 -0.3 ..... **\$6.75 EA** ⚠

**Valve**

**1 Groove**



- 838437** ..... **35-40**
- Intake 0.296 -0.15 ..... **\$15.50 EA** ⚠
- 838717** ..... **35-40**
- Exhaust (1 groove) 0.297 -0.4 ..... **\$102.75 EA** ⚠
- 3835318** ..... **41-49**
- Exhaust (2 groove)
- Note: replaces 839412 single groove. Must use 3835392 cap and 3835333 seal.
- 0.297 -0.15 ..... **\$33.75 EA** ⚠
- 839504** ..... **41-49**
- Intake (1 groove) 0.296 -0.4 ..... **\$15.50 EA** ⚠

**2-Groove**



- 3688065** ..... **41-53**
- Intake (2 groove) exc 50 & later 235ci. 0.296 -0.2 ..... **\$25.25 EA** ⚠
- 3835608** ..... **41-53**
- Exhaust exc 50 & later 235ci (2 groove) 0.297 -0.15 ..... **\$17.50 EA** ⚠
- 3835519** ..... **50-52**
- Intake, 235ci only (1 groove). 0.296 -0.3 ..... **\$15.50 EA** ⚠
- 3683569** ..... **50-62**
- Exhaust, 216 1950-1953, 235 1950-1962 (2 grooves). 0.297 -0.4 ..... **\$27.00 EA** ⚠
- 3835910** ..... **53-62**
- Intake, 235ci only (2 grooves). 0.296 -0.15 ..... **\$17.00 EA** ⚠

**Valve Spring Cap**



- 837264N** ..... **35-42**
- Valve spring cap (NOS) 0.309 -0.15 ..... **\$2.00 EA** ⚠



- 837624** ..... **35-47**
- Inlet (set of 6) 0.309 -0 ..... **CALL** ⚠



- 3835392N** ..... **47-48**
- Valve Spring Cap (NORS) 0.309 -0.2 ..... **\$2.50 EA** ⚠

**Valve Springs**



- 3835626** ..... **28-52**
- 216ci engines 0.303 -0.15 ..... **\$4.75 EA** ⚠
- 3704142** ..... **53-58**
- 235ci & 261ci engines 0.303 -0.2 ..... **\$7.75 EA** ⚠

**Valve Seals**



- 3835333** ..... **38-57**
- 12 pcs 0.308 -0.3 ..... **\$8.50 SET** ⚠

**Valve Stem Locks**



- 838029** ..... **34-57**
- Key (12 pcs) 0.310 -0.2 ..... **\$8.00 SET** ⚠

**Rocker Arm Shaft**



- 839592** ..... **40-58**
- Requires 2 0.353 -0 ..... **CALL** ⚠

**Rocker Arm**



- 837385B** ..... **34-54**
- Adjusting screw & nut. 0.429 -0.4 ..... **\$15.00 EA** ⚠

**Rocker Assembly**



- 838244B** ..... **37-39**
- Fits 216ci (\$100 core) 0.352 -0.15 ..... **\$425.00 PR** ⚠
- 609925** ..... **40**
- Fits 216ci (\$100 core) 0.352 -0.15 ..... **\$295.50 PR** ⚠
- 609924** ..... **41-53**
- Fits 216ci (\$100 core) 0.352 -0.15 ..... **\$335.00 PR** ⚠

**Rocker Assembly, cont.**

- 3729191** ..... **50-58**
- 235ci (\$100 core) 0.352 -0.15 ..... **\$363.50 PR** ⚠

**Lifters**



- 838774** ..... **29-39**
- Solid 0.459 -0.15 ..... **\$12.25 EA** ⚠



- 839263A** ..... **37-55**
- Solid, NOS original 40-55 (37-39 must be used w/ pushrods) 0.459 -0.15 ..... **\$19.75 EA** ⚠

#3835776) 0.459 -0.15



- 5230850** ..... **50-58**
- Hydraulic, w/ Powerglide 0.459 -0.15 ..... **\$19.50 EA** ⚠

**Pushrods**



- 3835776** ..... **37-53**
- 10-1/4". Fits 216ci, 37-39, use w/ lifter #839263 0.426 -0.4 ..... **\$13.00 EA** ⚠
- 3836261** ..... **41-55**
- 10-5/8". All 235ci exc Powerglide 0.426 -0.4 ..... **\$13.00 EA** ⚠
- 3835777** ..... **50-62**
- 11-1/4". All 235ci w/ Powerglide 0.426 -0.2 ..... **\$13.00 EA** ⚠

**Camshaft**



- 3836491** ..... **37-53**
- For solid lifters, new 0.519 -0.15 ..... **\$195.00 EA** ⚠
- 3836485** ..... **50-53**
- For hydraulic lifters, new 0.519 -0.15 ..... **\$285.00 EA** ⚠
- 3836485R** ..... **50-53**
- For hydraulic lifters, reground (\$100 core) 0.519 -0.2 ..... **\$125.00 EA** ⚠
- 3713919** ..... **54-55**
- For solid lifters, new, exc Powerglide & 261ci (for 261ci use part #3836484) 0.519 -0.15 ..... **\$182.50 EA** ⚠
- 3713919R** ..... **54-55**
- For solid lifters reground (\$40 core) exc Powerglide & 261ci (for 261ci use part #383684R) 0.519 -0 ..... **CALL** ⚠
- 3836484** ..... **54-58**
- For solid lifters, new, 235ci, 261ci 0.519 -0.15 ..... **\$285.50 EA** ⚠
- 3836483** ..... **54-62**
- For hydraulic lifters, new 0.519 -0.15 ..... **\$143.50 EA** ⚠
- 3836483R** ..... **54-62**
- For hydraulic lifters, reground (\$40 core) 0.519 -0 ..... **CALL** ⚠

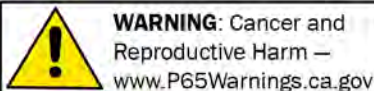

Chemicals shipped domestic ground only (Lower 48 states only). No international shipping.

**Phone: (360) 816-0211 • (800) 999-CHEV (2438) • www.chevsofthe40s.com**



**Camshaft, cont.**

**3836484R** ..... **54-62**  
For solid lifters, reground, 235ci, 261ci  
(\$40 core) 0.519 -0 ..... **CALL** ⚠

**Camshaft Bearings**



**838846B** ..... **37-53**  
Camshaft bearings.  
0.539 -0.15 .....  
**\$39.25 SET** ⚠

**3836191** ..... **54-58**  
Camshaft bearings 0.539 -0.15 .....  
**\$53.00 SET** ⚠

**Camshaft Thrust Plate And Spacer**



**3702305** ..... **37-57**  
Thrust plate & spacer  
0.533 -0.15 .....  
**\$25.75 SET** ⚠

**Camshaft Thrust Plate Screws**



**3702305A** ..... **37-57**  
Thrust plate screws  
0.533 -0.3 ..... **\$1.50 SET**  
⚠

**Timing Gear Cover**



**838869C** ..... **37-62**  
Timing gear cover  
chrome. Fits cars and  
trucks 1937-62 216ci ,  
235ci, 261ci also fits

GMC 1939-1959 trucks with 228ci,  
248ci, 270ci and 302ci engines -0 ..  
**\$64.25 EA** ⚠

**Timing Gear**



**3835371B** ..... **37-62**  
Aluminum crank & camshaft gear.  
Matched set 0.728 -0.15 ..... **\$151.25 SET**  
⚠

**Woodruff Keys**



**106751** ..... **ALL**  
For harmonic balancer,  
crank and cam gears (3  
pcs) 8.960 -0.4 ..... **\$2.75 SET** ⚠

**Dampner Balancer**



**605203** ..... **37-54**  
Sleeve, repair seal  
surface on crank  
dampner 0.659 -0.2  
..... **\$11.00 EA** ⚠

**605635** ..... **ALL**  
Recondition yours. 216ci, 235ci engines.  
0.659 -0.15 ..... **\$199.50 EA** ⚠

**Engine Bolt Kit Stainless Steel**



**368253A** ..... **37-53**  
Hex head Chevy 216ci (exc 53 powerglide)  
includes bolts for distributor, side cover,  
valve cover, timing cover, thermostat, oil  
pan, intake & exhaust, fuel pump & water  
pump, also includes lube. 0.386 -0.15

**\$69.00 SET** ⚠  
**3836614A** ..... **53-54**  
Hex head for a Chevy 235ci engine.

Includes bolts for distributor, side cover,  
valve cover, timing cover, thermostat, oil  
pan, intake & exhaust, fuel pump & water  
pump and lube. 0.386 -0.15 .....

**\$77.25 SET** ⚠  
**3836614B** ..... **55-62**

Hex head for a Chevy 235/ 261ci engine.  
Includes bolts for distributor, side cover,  
valve cover, timing cover, thermostat, oil  
pan, intake & exhaust, fuel pump & water  
pump and lube. 0.386 -0.15 .....

**\$77.00 SET** ⚠

**Stove Bolt**



**839301** ..... **40-60**  
W/ lock washer correct  
for timing cover,  
pushrod cover & oil pan  
(8 pcs) 1.428 -0 .....

**\$8.00 SET** ⚠

**Cylinder Head Bolts**



**3837543** ..... **34-62**  
Long - Used 0.293 -0.15 ..... **\$4.75 EA** ⚠

**3837544** ..... **37-62**  
Short 0.293 -0.4 ..... **\$8.50 EA** ⚠

**Manifold Clamps & Bolts**



**838546B** ..... **37-57**  
Intake - Exhaust manifold clamps  
(spreaders). Cast reproduction. 3.273 -0.15  
..... **\$55.25 SET** ⚠

**Manifold Clamps & Bolts, cont.**



**838546BK** ..... **37-57**  
Intake - Exhaust  
manifold bolt kit  
3.273 -0.3 .....



**\$5.00 SET** ⚠  
**838546U** ..... **37-57**  
Intake - Exhaust  
manifold clamps  
(spreaders). used  
3.273 -0 .....

**\$50.00 SET** ⚠

**Sleeves Metal**



**837273** ..... **34-53**  
Intake to head 216ci. Exc 50-53 235ci (3  
piece set) 3.281 -0.15 ..... **\$7.50 SET** ⚠

**3835506** ..... **50-62**  
Intake to head 235ci,  
261ci (3 piece set)

3.281 -0.15 ..... **\$7.50 SET** ⚠

**Engine Assembly Lube**

Synthetic oils enable Royal Purple to make  
superior lubricants, but it is Royal Purple's  
advanced Synslide additive technology  
that gives Royal Purple's EP lubricants their  
amazing performance. Engine Performance  
magazine raves about this product.



**986047** ..... **ALL**  
Clevite Bearing  
Guard, 8 oz bottle.  
8.800 -0.15  
..... **\$10.25 EA** ⚠



**986047D** ..... **ALL**  
Royal Purple.  
Synthetic, 8 oz  
bottle. 8.800 -0  
..... **\$19.75 EA** ⚠

**Timing Hole Plug**



**836802A** ..... **ALL**  
Rubber (rare) 0.714 -0.15  
..... **\$10.75 EA** ⚠





**Soft Plug Set**



**3835121.....37-54**  
For complete plug kit you'll also need expansion plug  
#838127 0.034-0.2  
**\$10.00 SET** ⚠

**Expansion Plug**



**838127.....38-54**  
Block, rear of camshaft  
1-31/32in. 0.553-0.15  
**\$1.00 EA** ⚠



**838128.....38-54**  
Block, rear of camshaft  
1-5/8in. 0.553-0.4  
**\$15.00 EA** ⚠

**Oil Pan Plug**



**344690.....28-57**  
W/ washer, 1/2 in., standard size 1.456-0.4  
**\$3.50 EA** ⚠

**344690B.....28-57**  
W/ washer, 1/2 in., single oversize  
1.456-0.2 **\$4.75 EA** ⚠

**344690C.....28-57**  
W/ washer, 1/2 in., double oversize  
1.456-0.15 **\$3.00 EA** ⚠

**344690D.....28-57**  
W/ washer, 1/2 in., triple oversize  
1.456-0.15 **\$2.50 EA** ⚠

**Alignment Tool**



**38352226.....37-53**  
Tool used to align oil dipper troughs in pan (\$375 refundable deposit upon return of tool) 1.427-0.15 .....starting at **\$477.00 Rent** ⚠

**Gasket Oil Fill Cap**



**836446.....31-48**  
Oil Fill Cap Gasket. Exc 48 3/4T & larger  
1.517-0.2 **\$2.25 EA** ⚠

**Oil Dip Stick Tube**



**838179.....37-39**  
Dip Stick 1.516-0 **CALL** ⚠  
**3685702.....49-54**  
Dip Stick Tube. Cut to length 6 3/4in.  
1.516-0 **CALL** ⚠

**Oil Pressure Line**



**609912.....36-53**  
Rocker arm, exc Powerglide w/ 235ci  
1.519-0.15 **\$28.50 EA** ⚠



**1399637B.....37-54**  
Engine to oil gauge.  
1.519-0.2 **\$26.00 EA** ⚠



**217276A.....50-55**  
NOS rocker arm oiler kit  
1.519-0.15 **\$15.00 EA** ⚠

**Oil Distributor Valve**



**839173.....40-53**  
Oil Distributor Valve  
Gasket 1.790-0.3  
**\$3.25 EA** ⚠

**Oil Pickup Grommet**



**3701563.....53-54**  
Grommet, oil pickup  
tube to screen  
assembly 1.664-0.4  
**\$1.75 EA** ⚠

**Oil Pump**



**838440.....37-39**  
For 216ci engine 1.652-0.15  
**\$195.00 EA** ⚠

**Oil Pump, cont.**

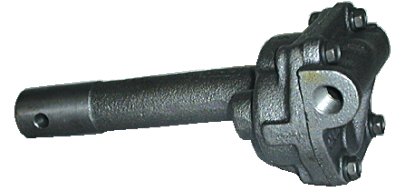

**839157.....40-53**  
Fits 216 & 235ci (exc 53 Powerglide).  
1.652-0.15 **\$299.00 EA** ⚠



**839157A.....40-53**  
Rebuild kit, exc Powerglide 1.652-0  
**CALL** ⚠



**839164.....40-53**  
Drive gear. Exc 53  
Powerglide (NOS)  
1.659-0.4 **\$5.00 EA** ⚠



**3702363.....53-54**  
Fits 235ci, exc 53 stick 1.652-0.15  
**\$200.00 EA** ⚠



**3702363A.....53-54**  
Rebuild kit, exc 53 stick 1.652-0.15  
**\$75.00 EA** ⚠

**Bee Hive Oil Filter**



**5573017A.....ALL**  
Super reproduction,  
painted. Hard to find  
item 1.836-0.15  
**\$225.00 EA** ⚠



**5573017C.....ALL**  
Mount bracket for Bee  
Hive Oil Filter, painted  
1.836-0.15  
**\$23.25 EA** ⚠



**WARNING: Cancer and Reproductive Harm** —  
www.P65Warnings.ca.gov

Chemicals shipped domestic ground only (Lower 48 states only). No international shipping.

**Phone: (360) 816-0211 • (800) 999-CHEV (2438) • www.chevsofthe40s.com**

**Bee Hive Oil Filter, cont.**



**5573017FILT. . . ALL**  
Filter Element for  
Beehive, 5" x 4"  
1.836 -0.15  
..... **\$14.25 EA** ⚠



**5573017GASK .ALL**  
Gasket For Beehive  
Filter 1.836 -0.15  
..... **\$3.75 EA** ⚠

**Oil Filter Element**



**5572288A. . . . ALL**  
3-1/2 in. o.d. x  
4-1/16 in. high,  
#P203. 1-1/8 in. I.D.  
1.836 -0.15  
..... **\$25.75 EA** ⚠



**5572288B. . . . ALL**  
4-1/16 in. o.d. x  
4-11/16 in. high.  
1.836 -0.15  
..... **\$29.50 EA** ⚠



**5572288C. . . . ALL**  
4-1/4 in. o.d. x 5  
in. high, #P115 I.D.  
9/16 in. 1.836 -0.15  
..... **\$37.00 EA** ⚠



**5572288D. . . . ALL**  
4-1/16 in. o.d.  
x 7-3/4 in. high,  
#P117. Inside  
hole 9/16 in. i.d.  
1.836 -0.15  
..... **\$30.75 EA** ⚠

**Oil Filter Hose**



**3654629 . . . . . 29-54**  
19 in. 3.163 -0.15 . . . . . **\$47.00 EA** ⚠  
**3702341 . . . . . 37-54**  
13 in. 3.163 -0.15 . . . . . **\$49.00 EA** ⚠

**Odds And Ends, cont.**

Please call for availability on all Odds & Ends parts. Once part is sold, it may no longer be in stock.

**605487N . . . . . 29-32**  
Connecting rod bolts NOS 0.623 -0 . . . . .  
**\$23.00 EA** ⚠  
**362477 . . . . . 29-36**  
Wrist Pins, .003 O.S. (NOS) 1.000 -0.4 . . . . .  
**\$6.00 SET** ⚠  
**838774N. . . . . 29-39**  
Lifters (Solid) (NOS) 0.459 -0.2 **\$22.00 EA**  
⚠  
**364822. . . . . 33-34**  
Piston rod. Fits passenger, CC & DC  
standard bore only. 0.603 -0.4 . . . . .  
**\$150.00 EA** ⚠  
**609533N . . . . . 33-36**  
Timing Gear Cover (NOS) 0.206 -0.4 . . . . .  
**\$65.00 EA** ⚠  
**836867. . . . . 33-36**  
Rocker Arm Shaft Oil Connector (NOS)  
1.928 -0.4 . . . . . **\$12.00 EA** ⚠  
**837365. . . . . 34-37**  
Valve Spring All exc dc 0.303 -0.3 . . . . .  
**\$3.75 EA** ⚠  
**838999. . . . . 34-40**  
Rocker Arm- Exhaust 0.333 -0.4 . **\$7.00 EA**  
⚠  
**837385U . . . . . 34-54**  
Rocker arm & nut used 0.429 -0.4 . . . . .  
**\$5.00 EA** ⚠  
**837656. . . . . 35-36**  
Oil pan seal at front crankcase. NOS-shelf  
worn. 0.213 -0.2 . . . . . **\$3.00 EA** ⚠



**837264N. . . . . 35-42**  
Valve spring cap (NOS)  
0.309 -0.15 . . . . . **\$2.00 EA**  
⚠

**838220. . . . . 37-39**  
Rocker Shaft Sleeve 1/8in. Id On One  
End, 1/2in. Id On Other End 1.928 -0.15 . . . . .  
**\$2.00 EA** ⚠  
**838244. . . . . 37-39**  
Shaft Valve Rocker Arm (12-1/16in.  
Overall Length) 0.353 -0.4 . . **\$15.00 EA** ⚠  
**838963N . . . . . 37-39**  
Body oil distributor valve (NOS) 1.785 -0.4  
. . . . . **\$20.00 EA** ⚠  
**6028060N . . . . . 37-40**  
Pistons. Fits 216ci standard bore (NOS).  
0.629 -0.4 . . . . . **\$41.75 EA** ⚠  
**60280660A . . . . . 37-40**  
Piston .060in. 0.629 -0.4 . . . **\$45.00 EA** ⚠  
**60280680A . . . . . 37-40**  
Pistons .080in. (NOS) 0.629 -0.4 . . . . .  
**\$35.00 EA** ⚠  
**60280680N . . . . . 37-40**  
Pistons. 216ci Engine .080 over (NOS)  
0.629 -0.4 . . . . . **\$200.00 SET** ⚠  
**838993. . . . . 37-40**  
Rocker Arm- Left Intake 0.333 -0.4 . . . . .  
**\$7.00 EA** ⚠

**Odds And Ends, cont.**

**838994. . . . . 37-40**  
Rocker Arm- Right Intake 0.333 -0.4 . . . . .  
**\$7.00 EA** ⚠  
**3847065N . . . . . 37-47**  
Main bearing-front intermediate 0.099 -0.4  
. . . . . **\$10.00 EA** ⚠  
**00205. . . . . 37-53**  
Cambearings .030 (NOS) 0.539 -0.4 . . . . .  
**\$15.50 SET** ⚠  
**3835246 . . . . . 37-53**  
Pushrod cover seal. Cork. Fits all 216ci  
0.454 -0.4 . . . . . **\$1.00 EA** ⚠  
**3835344 . . . . . 37-53**  
Push rod cover. Fits 216ci (Used) 1.000 -0.4  
. . . . . **\$25.00 EA** ⚠



**608202 . . . . . 37-53**  
Rings for 216ci .020  
(NOS) 0.643 -0.4 . . . . .  
**\$60.00 SET** ⚠

**838246. . . . . 37-53**  
Rocker shaft support with 216 0.349 -0.4  
**\$40.00 EA** ⚠  
**355936. . . . . 37-54**  
Valve rocker shaft retainer hair pin  
0.376 -0.4 . . . . . **\$5.00 EA** ⚠  
**3835508 . . . . . 37-54**  
Rocker arm shaft spring (2-5/16" length)  
0.376 -0.4 . . . . . **\$8.00 EA** ⚠  
**602325. . . . . 37-57**  
Shims for crankshaft front bearing  
0.146 -0.4 . . . . . **\$5.00 SET** ⚠  
**839304. . . . . 38-50**  
Spring Valve All Exc PG (NOS) 0.603 -0.2 . . . . .  
**\$3.00 EA** ⚠  
**3847075N . . . . . 40-47**  
Main bearing, .020 (NOS) 0.096 -0.4 . . . . .  
**\$10.00 EA** ⚠  
**609121. . . . . 40-50**  
Shims for crankshaft rear bearing  
0.153 -0.4 . . . . . **\$5.00 EA** ⚠  
**3712747. . . . . 40-52**  
Pipe & Cover Oil Pump (NOS) 1.664 -0.4 . . . . .  
**\$20.00 EA** ⚠  
**3695373 . . . . . 41-55**  
Exhaust Valve Rotor Assembly 0.309 -0.2  
. . . . . **\$3.00 EA** ⚠



**3835392N . . . . . 47-48**  
Valve Spring Cap  
(NORS) 0.309 -0.2 . . . . .  
**\$2.50 EA** ⚠

**3835548 . . . . . 50**  
Rocker Arm. Exhaust, 235ci Engine  
0.333 -0.4 . . . . . **\$16.00 EA** ⚠  
**3701490 . . . . . 53-61**  
Connecting Rod (fits 53 Pg & All 54-61)  
0.603 -0.4 . . . . . **\$75.00 EA** ⚠  
**3731676. . . . . 54-60**  
Piston ring set. NOS, fits 261ci engine,  
standard bore. 0.643 -0.4 . **\$60.00 SET** ⚠  
**3836026 . . . . . 55**  
Exhaust Valves (Pass Exc P/g) (NOS)  
0.297 -0.4 . . . . . **\$10.00 EA** ⚠

Returns require a return authorization number—call first. • Product pricing & availability subject to change.

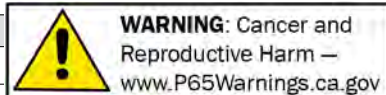



**Odds And Ends, cont.**

- 3720106**.....**55-57**  
Dipstick-powerglide (Used) 12.000-0.4 ...  
**\$35.00 EA** ⚠
- 3728993N** .....**55-57**  
Rear main bearings (NOS) 0.960-0.4 ....  
**\$15.00 PR** ⚠
- 3836755** .....**57**  
Valve spring cap cover V-8 0.308-0.4 ....  
**\$10.00 SET** ⚠
- 3730859** .....**57-58**  
Exhaust Valve, All exc Powerglide 1.000-0.3  
..... **\$4.00 EA** ⚠
- 38355144** .....**ALL**  
Push rod cover used 235ci (10 bolt holes  
5-21/32 x 27) 0.439-0 ..... **\$25.00 EA** ⚠
- 955-INEX** .....**ALL**  
Oil Regulator Valve Silencing Cap 0.303-0.4  
..... **\$20.00 SET** ⚠

**SECTION 024C  
RESTORATION PARTS**

**Rear Main Seal**



**3835774G**.....**40-58**  
As original rope.  
Replaces original  
asbestos type.  
Graphite (2 pcs).

0.137 -0.15

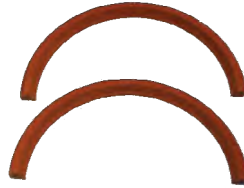

**3835774R** .....**56-62**  
Rubber (2 pcs) 235-261 0.137 -0.15  
..... **\$54.25 SET** ⚠

**Overhaul Gasket**

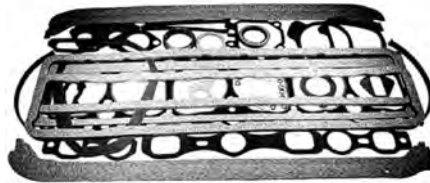

**3702872**.....**37-53**  
Overhaul complete set. All 216ci (exc 53  
P.G.) 0.010 -0.15 ..... **\$148.75 SET** ⚠

**3702872A** .....**50-52**  
Overhaul complete set. Fits 235ci. 0.010-0

..... **\$199.00 SET** ⚠

**PORCLEAN** .....**ALL**

Porclean, 1 quart. 03.001 -0.15  
..... **\$11.69 EA** ⚠



**3719628**.....**53-62**  
Overhaul complete set. Fits 235ci  
0.010 -0.15 ..... **\$156.25 SET** ⚠



**3836107B** .....**54-62**  
Overhaul complete set. Fits 261ci  
0.010 -0.15 ..... **\$123.25 SET** ⚠

**Oil Pan Gasket**



**602373**.....**37-39**  
Oil pan 1.429-0.15 ..... **\$20.50 SET** ⚠



**604338**.....**40-55**  
Oil pan 1.429-0.15 ..... **\$19.75 SET** ⚠

**Head Gasket**



**839541**.....**37-53**  
Head gasket 216ci motor. 0.289 -0.15  
..... **\$56.00 EA** ⚠

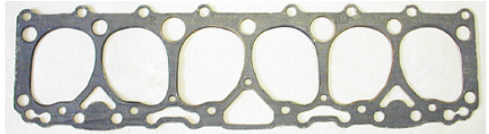

**3835562** .....**50-52**  
Head gasket 235ci motor 0.289 -0.15  
..... **\$127.75 EA** ⚠



**3701296** .....**53-62**  
Head gasket 235ci motor 0.289 -0.15  
..... **\$67.25 EA** ⚠



**3836107**.....**54-62**  
Head gasket for 261ci 0.289 -0.15  
..... **\$83.75 EA** ⚠

**Valve Cover Gasket**



**3694248** .....**37-53**  
Valve cover 1/4in. thick 0.423 -0.15  
..... **\$14.25 EA** ⚠



**3696781** .....**54-62**  
Valve cover cork. 0.423 -0.15  
..... **\$16.50 EA** ⚠



**WARNING: Cancer and Reproductive Harm** —  
www.P65Warnings.ca.gov

Chemicals shipped domestic ground only (Lower 48 states only). No international shipping.

**Phone: (360) 816-0211 • (800) 999-CHEV (2438) • www.chevsofthe40s.com**



# Section 024C: Engine Gaskets & Seals

## Valve Grind Gasket

Valve Grind Gasket Sets Include:  
 Head gasket  
 Valve cover gasket  
 Push rod cover gasket  
 Intake and exhaust manifold gaskets  
 Thermostat housing gaskets

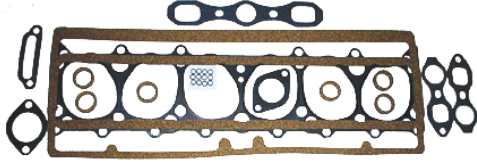

**3691929** ..... **37-53**  
 Valve Grind Exc 50-53 235ci. 0.289-0.15  
 ..... **\$80.25 SET** ⚠



**370738** ..... **50-53**  
 Valve Grind Fits 235ci, exc 53 Powerglide.  
 0.289-0.15 ..... **\$72.00 SET** ⚠



**3709428** ..... **53-62**  
 Valve Grind Fits 235ci, exc 53 manual  
 trans 0.289-0.15 ..... **\$95.25 SET** ⚠



**3709429** ..... **54-57**  
 Valve Grind Fits 261ci 0.289-0.15  
 ..... **\$59.00 SET** ⚠

## Front Timing Cover Seal



**3835946** ..... **37-58**  
 Front of timing cover.  
 0.209-0.3 .....  
**\$13.75 EA** ⚠

## Timing Cover Gasket



**839048B** ..... **37-62**  
 Timing Cover Complete set w/ seal  
 0.005-0.15 ..... **\$26.50 SET** ⚠

## Push Rod Cover Gasket



**602336** ..... **37-53**  
 Push rod Cover Gasket w/ plug seals. Exc  
 50-53 235ci 0.443-0.15 ..... **\$29.00 SET**  
 ⚠



**3835515** ..... **50-62**  
 Push rod Cover Paper. Fits 235ci & 261ci  
 0.443-0.15 ..... **\$16.75 SET** ⚠

## Intake And Exhaust Manifold Gasket



**602483A** ..... **37-53**  
 Intake & exhaust  
 manifold. Fits 216ci  
 (3pcs) 3.270-0.15 ..... **\$22.75 SET** ⚠



**3707045** ..... **50-62**  
 Intake & exhaust manifold. Fits 235ci &  
 261ci (3pcs) 3.270-0.15 ..... **\$21.50 SET**  
 ⚠

## Manifold Gasket



**838290** ..... **37-53**  
 Rectangle between  
 manifolds. Fits 216ci  
 3.272-0.15 .....  
**\$7.00 EA** ⚠



**3835572** ..... **50-62**  
 Rectangle between  
 manifolds. Fits 235ci &  
 261ci 3.272-0.15  
**\$7.75 EA** ⚠

## Oil Fill Cap Gasket



**836446** ..... **31-48**  
 Oil Fill Cap Gasket. Exc 48 3/4T & larger  
 1.517-0.2 ..... **\$2.25 EA** ⚠

## Oil Distributor Valve Gasket



**839173** ..... **40-53**  
 Oil Distributor Valve  
 Gasket 1.790-0.3  
 ..... **\$3.25 EA** ⚠

## Gasket Sealer



**1015BP** ..... **ALL**  
 Gasket sealer, high  
 temp silicone. Black  
 (3.35 oz tube).  
 8.800-0.15  
 ..... **\$12.75 EA** ⚠

## Engine Assembly Lube



**986047** ..... **ALL**  
 Clevite Bearing  
 Guard, 8 oz bottle.  
 8.800-0.15  
 ..... **\$10.25 EA** ⚠



**986047D** ..... **ALL**  
 Royal Purple.  
 Synthetic, 8 oz  
 bottle. 8.800-0  
 ..... **\$19.75 EA** ⚠

Returns require a return authorization number—call first. • Product pricing & availability subject to change.



**WARNING:** Cancer and  
 Reproductive Harm —  
 www.P65Warnings.ca.gov

**SECTION 026C  
STREET ROD PARTS**

**Frame Adapters Chevy V8  
Transplants**



**3659291M . . . . .37-48**  
Bolt-in, for Chev V8 into  
37-48 Chev Car  
0.027 -0.15 . . . . .

**\$108.00 PR** ⚠



**3693425N . . . . .37-54**  
Weld-in, for Chev V8  
into 37-54 Chev Car  
0.027 -0.2 . . . . .

**\$85.00 PR** ⚠

**SECTION 026C  
RESTORATION PARTS**

Note: Transmission Mounts see Section 150C

**Motor Mount Front**



**3693425 . . . . .35-51**  
2 per car 0.027 -0.2

**\$25.50 EA** ⚠



**3700332B . . . . .52-54**  
1 upper, 1 lower (2  
pairs per car). 0.027 -0

. . . . . **\$26.25 PR** ⚠

**Motor Mount Rear**



**377928 . . . . .35-48**  
Rectangular shape (2  
per car), fits all 35-47 &  
48 Cabriolet. 0.027 -0.1

. . . . . **\$26.00 EA** ⚠



**756057 . . . . .35-48**  
M shaped (exc.  
Cabriolet). 2 per car.  
Original 48 part,  
requires use of 48

engine brackets. 0.027 -0 . **\$28.25 EA**



**3688111 . . . . .49-51**  
2 per car 0.027 -0.3  
**\$16.00 EA** ⚠

**SECTION 030C  
STREET ROD PARTS**

**Radiator Aluminum**

- ALUMRAD..... 37**  
Billet fill neck, rear mount. 1.219 -0.15  
**\$612.00 EA** ⚠️
- ALUMRADT..... 37**  
Rear mount fill neck w/ internal trans cooler. 1.219 -0.15 ..... **\$685.00 EA** ⚠️
- ALUMRAD ..... 38-39**  
Top mount fill neck, offset. 1.219 -0.15 .. **\$680.00 EA** ⚠️
- ALUMRADT..... 38-39**  
Top mount fill neck, offset w/ internal trans cooler. 1.219 -0.15 . **\$685.00 EA** ⚠️
- ALUMRAD ..... 40-41**  
Top mount fill neck, offset. 1.219 -0.15 .. **\$612.00 EA** ⚠️
- ALUMRADT..... 40-41**  
Top mount fill neck, offset w/ internal trans cooler. 1.219 -0.15 . **\$685.00 EA** ⚠️
- ALUMRAD ..... 42-48**  
Top mount fill neck, offset. Size 19 3/4" W X 24" H. 1.219 -0.15 ..... **\$578.00 EA** ⚠️
- ALUMRADT..... 42-48**  
Top mount fill neck, offset w/ internal trans cooler. Size 19 3/4" W X 24" H. 1.219 -0.15 ..... **\$630.25 EA** ⚠️
- ALUMRAD ..... 49-54**  
Top mount fill neck, offset. Size: 23" H X 22" W. 1.219 -0.15 ..... **\$578.00 EA** ⚠️
- ALUMRADT..... 49-54**  
With internal trans cooler. 12" without overdrive trans, 20" with overdrive trans. 1.219 -0.15 ..... **\$650.75 EA** ⚠️

**Radiator Aluminum (ALUMRAD) Upgrades**

- ALUMRADACMOUNT..... ALL**  
Mount AC condenser to radiator 1.219 -0.15 ..... **\$40.00 EA** ⚠️
- ALUMRADFAN..... ALL**  
Electric fan for aluminum radiators. 16", 2360CFM. Straight fan blades. 1.219 -0.15 ..... **\$150.25 EA** ⚠️
- ALUMRADFANCOVER..... ALL**  
Polished aluminum fan cover for electric fan. 1.219 -0.15 ..... **\$60.25 EA** ⚠️
- ALUMRADFANMOUNT ..... ALL**  
Mount Fan to radiator 1.219 -0 ..... **\$65.00 EA** ⚠️
- ALUMRADFANWIRE ..... ALL**  
Single Fan Wiring Harness 1.219 -0 ..... **\$127.00 EA** ⚠️
- ALUMRADSHROUD ..... ALL**  
Aluminum fan shroud for radiators listed above. 1.219 -0.15 ..... **\$99.75 EA** ⚠️
- POLISHRAD ..... ALL**  
Upgrade your radiator to a fully polished. 1.219 -0 ..... **\$125.00 EA** ⚠️
- POLISHSHROUD..... ALL**  
Upgrade fan shroud to polished 1.219 -0.15 ..... **\$40.00 EA** ⚠️

**Radiator (Aluminum) Stamped Tanks**

High efficiency all aluminum, dual large core radiator with transmission cooler.  
Dual 1 1/8" high flow tubes; double the capacity of stock 2-row. 33% more capacity than 3-row 1/2"



- 3121096A ..... 42-48**  
100 percent TIG welded  
All Aluminum  
16 fins per inch  
Corrugated fins that

give more surface area and more thermal transfer

Pressure tested  
For manual trans  
Direct fitment for 43-48 Chevy Car  
Upper Hose 1.25 Inch  
Lower Hose 1.50 Inch 1.219 -0 .....

- \$450.00 EA** ⚠️



- 3130944AL ..... 49-54**  
Chevy Cars W/ V8  
1.219 -0.15 ..... **\$380.00 EA** ⚠️

**Radiator V8 Copper Brass**

Copper radiators for Chevrolet small block V8.



- 313904541 ..... 40-41**  
Chevy Car W/ V8 small block, 4 core w/ trans cooler. 1.219 -0.15 . **\$677.75 EA** ⚠️
- 313904548 ..... 42-48**  
Chevy Car W/ V8 small block, 4 core w/ trans cooler. 1.219 -0.15 .. **\$677.50 EA** ⚠️
- 313904554 ..... 49-54**  
Chevy Car V8 small block, 4 core w/ trans cooler. Includes U-nuts. 1.219 -0.15 .... **\$548.25 EA** ⚠️

**Radiator Brace V Rod**



- 597498..... 37-38**  
Radiator To Cowl (polished Stainless Steel)  
1.309 -0.15 ..... **\$159.75 EA** ⚠️

**Radiator Brace V Rod, cont.**

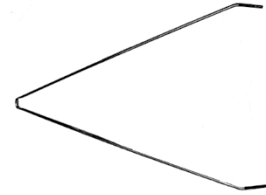

- 350332..... 39**  
39 Car. Radiator to cowl. Polished stainless steel. 1.309 -0.15 . **\$202.50 EA** ⚠️

**SECTION 030C  
RESTORATION PARTS**

**Radiator Copper Brass**

Oversize shipping charges apply. Please call for rate.

The following radiators use petcock part number 3663932

- 3109032 ..... 38**  
6 cylinder, 3 core 1.219 -0.15 ..... **\$448.75 EA** ⚠️



- 3114869 ..... 40-41**  
6 cylinder, 3 core 1.219 -0.15 ..... **\$448.75 EA** ⚠️
- 3121096 ..... 42-48**  
6 cylinder, 3 core 1.219 -0.15 ..... **\$448.75 EA** ⚠️
- 3130944 ..... 49-54**  
6 cylinder, 3 core 1.219 -0.15 ..... **\$620.00 EA** ⚠️

**Trans Cooler Lines**

Oversize shipping charges apply. Please call for rate.

- 348750T..... 50-54**  
Steel, Pre-bent. Powerglide (specify year when ordering). 8.964 -0 ..... *starting at* **\$45.00 SET** ⚠️
- 348750TS ..... 50-54**  
Stainless, Pre-bent. Powerglide (specify year when ordering). 8.964 -0 ..... *starting at* **\$75.00 SET** ⚠️

**Radiator Cap**



- 594498..... 37-47**  
No pressure 1.203 -0.2 ..... **\$9.25 EA** ⚠️



- 594498AC ..... 37-47**  
AC Delco RC-10. No pressure. 1.203 -0 .. **CALL** ⚠️

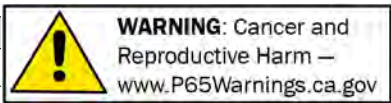



**Radiator Cap, cont.**



**850501.....48-53**  
4 lb genuine AC  
1.203-0.15 .....  
**\$12.00 EA** ⚠️



**850795R.....48-57**  
7 lbs. Not like original  
1.203-0.15 .....  
**\$7.50 EA** ⚠️



**850795.....54-57**  
7 lb genuine AC  
1.203-0.15 .....  
**\$15.00 EA** ⚠️

**Overflow Tank**



**985528.....37-54**  
Original GM  
accessory with  
hose, mounting  
bracket and screws  
1.290-0.15  
.....  
**\$127.25 EA** ⚠️

**Overflow Tank Decal**



**DEC03.....39-48**  
Gold with red wings.  
19.200-0.4 .....  
**\$6.50 EA** ⚠️



**DEC28.....49-54**  
Clear with orange  
lettering. 19.200-0.15  
.....  
**\$11.25 EA** ⚠️

**Overflow Tank Hose Set**



**601607B.....37-48**  
For accessory overflow tank w/ original  
GM instruction sheet 1.240-0.3 .....  
**\$14.50 SET** ⚠️

**601607C.....49-54**  
For accessory overflow tank w/ original  
GM instruction sheet 1.240-0.3 .....  
**\$14.50 SET** ⚠️

**Core Support Pads And Shims**



**367314.....33-54**  
Radiator core support mount 1.270-0.3  
.....  
**\$10.00 SET** ⚠️

**Core Support Bolt Kit**



**458395.....37-39**  
Radiator core support to frame. 1.270-0.2  
.....  
**\$3.50 SET** ⚠️



**3676480.....40-54**  
Radiator core support  
to frame. 1.270-0.4  
.....  
**\$3.25 SET** ⚠️

**Radiator U-nuts**



**005738.....49-54**  
Radiator to core support (6pcs) included  
with 1949-54 radiator (#3130944).  
1.219-0.4 .....  
**\$4.00 SET** ⚠️

**Radiator Petcock**



**134519.....37-39**  
Not as original.  
1.229-0.15 .....  
**\$5.25 EA** ⚠️



**3113456.....40-47**  
1/8" NPT 1.229-0.15  
.....  
**\$24.75 EA** ⚠️



**3663932.....48-52**  
This is a radiator drain  
valve known as a  
petcock. Fits 1948-52  
and also fits most

1953-57. 1.229-0.3 .....  
**\$5.00 EA** ⚠️



**3719518.....53-57**  
This is a radiator drain  
valve known as a  
petcock. Fits 1953-57.  
1.229-0.3 .....  
**\$4.25 EA**

**Petcock In Engine Block**

**120842.....ALL**  
1/8" NPT Fits Engine Block 8.951-0 ..  
**\$4.99 EA** ⚠️

**Radiator Wire Grommet**



**3689096.....49-54**  
Left of radiator  
1-5/16in. o.d. For  
headlight harness pass  
thru. 9.775-0.15 .....

**\$11.50 EA** ⚠️

**Radiator Hose Set**



**37013630.....37-40**  
(3 hose set) GM script hoses with 6  
original clamps & metal elbow (hoses are  
trim-to-fit) 1.159-0 .....  
**CALL** ⚠️

**3701363C.....41**  
(3 hose set) GM script hoses with 6  
original clamps & metal elbow 1.159-0.15  
.....  
**\$49.25 SET** ⚠️

**3702348B.....42-48**  
GM script hoses with 6 original clamps &  
metal elbow (3 hose set) 1.159-0.15 ....  
**\$67.25 SET** ⚠️



**3694277B.....49-54**  
Hoses with 4 original clamps (2 hose set).  
1.159-0.15 .....  
**\$32.00 SET** ⚠️

**3694277C.....50-54**  
(3 hose set) With 6 original clamps.  
Powerglide (hoses are trim-to-fit). 1.159-0.2  
.....  
**\$35.25 SET** ⚠️

**Radiator Hose Clamps**



**111616.....ALL**  
Upper hose (original) (2 pcs). 1.166-0.2  
.....  
**\$6.00 SET** ⚠️



**111619.....ALL**  
Lower hose (original) (2 pcs). 1-7/8"  
hoses. 5/8" band. 1.166-0.2 .....  
**\$6.00 SET** ⚠️

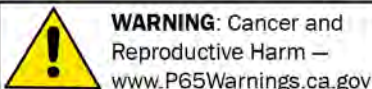

**WARNING: Cancer and Reproductive Harm** —  
www.P65Warnings.ca.gov

Chemicals shipped domestic ground only (Lower 48 states only). No international shipping.

**Phone: (360) 816-0211 • (800) 999-CHEV (2438) • www.chevsofthe40s.com**

030C

**Upper Hose**



**364382A** ..... **37-41**  
GM script, 5-5/8in. 1.159 -0.15 .....  
**\$6.00 EA** ⚠



**3702348** ..... **42-54**  
GM script molded upper hose. 1.159 -0.2  
..... **\$8.00 EA** ⚠

**Metal Elbow**



**378248** ..... **35-40**  
In lower hose. 1.173 -0.15 ..... **\$17.50 EA** ⚠  
**3656796** ..... **41-48**  
In lower hose. 1.173 -0.15 ..... **\$32.00 EA** ⚠

**Lower Hoses**

**3701363A** ..... **37-40**  
(2 pcs) (hoses are trim-to-fit). 1.159 -0.3  
**\$12.00 SET** ⚠  
**3701363B** ..... **41-48**  
(2 pcs). 1.159 -0.3 ..... **\$12.00 SET** ⚠  
**1255503** ..... **50-54**  
GM script, Powerglide (2 pieces) (hoses  
will need to be trimmed to fit) 1.159 -0.3  
**\$12.00 SET** ⚠

**Molded Lower Hose**



**3692230** ..... **41-48**  
GM script, replaces metal elbow & 2  
hoses. 1.173 -0.3 ..... **\$15.75 EA** ⚠  
**3694277** ..... **49-54**  
Moulded lower hose. 1.173 -0.15 .....  
**\$14.00 EA** ⚠

**Thermostat Housing**



**839232B** ..... **40-57**  
Lower thermostat  
housing / water neck,  
all 6 cyl. 1.251 -0.15  
**\$54.25 EA** ⚠



**839232T** ..... **40-57**  
Upper thermostat  
housing / water neck,  
all 6 cyl. 1.251 -0.15  
**\$50.50 EA** ⚠



**OTB-6413** ..... **ALL**  
1/2" aluminum  
thermostat housing  
spacer. Used to space  
thermostat housing

away from aftermarket valve covers.  
Includes mounting hardware. Fits 216ci,  
235ci, 261ci -0 ..... **\$55.25 EA** ⚠

**Thermostat**



**3123995** ..... **29-54**  
180 degree. 1.246 -0.3  
..... **\$20.25 EA** ⚠



**3133598** ..... **29-54**  
160 degree. 1.246 -0.2  
..... **\$12.75 EA** ⚠

**Thermostat Housing Gasket**



**838341** ..... **37-57**  
Thermostat housing  
gasket. Fits gooseneck.  
1.154 -0.2 ..... **\$2.50 EA**



**Gasket Head To Water Outlet**



**3838297** ..... **37-62**  
Head to water outlet  
1.252 -0.15 ..... **\$2.00 EA**



**Bushing**



**3837160** ..... **38-62**  
For temp gauge. 3/8"  
I.D. 1/2" NPT O.D.  
1.150 -0.15 .....  
**\$10.75 EA** ⚠

**Water Pump**

Note: 1937-38 & 1939-40 cores are becoming  
difficult to find. You may be required to send in  
your core for a rebuild.



**3741033** ..... **29-54**  
W/ short shaft (narrow) 3/8" pulley (not  
polished). For use on 55 & later 235ci &  
261ci engines (\$100 core). 1.069 -0  
..... **CALL** ⚠



**3741033LP** ..... **29-54**  
For doing a 235ci conversion in earlier  
chevys. Includes gasket for '55 & later  
235ci & 261ci 6-cylinders. 1.069 -0.3  
..... **\$160.00 EA** ⚠



**598308** ..... **37-38**  
W/ gasket (\$150 core). 1.069 -0.3  
..... **\$275.00 EA** ⚠

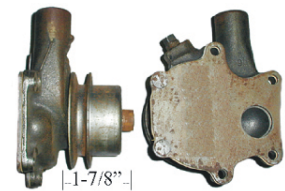

**838903** ..... **39-40**  
W/ gasket (\$150 core). 1.069 -0.3  
..... **\$225.00 EA** ⚠



**939467** ..... **41-52**  
W/ gasket (\$75 core). 1.069 -0.15  
..... **\$144.00 EA** ⚠



**Water Pump, cont.**

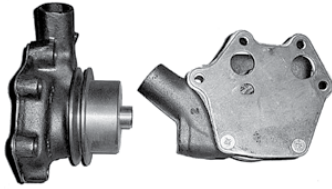

**3836804** .....**53-54**  
W/ gasket (narrow 3/8" pulley). \$75.00  
core charge. 1.069 -0.15 ..... **\$120.00 EA**

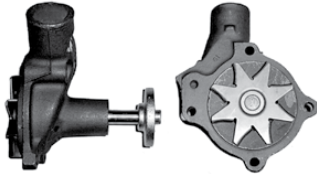

**3774212** .....**54-62**  
Fits 261ci. W/ Gasket 1.069 -0.15 .....  
**\$92.75 EA**



**WPADAPT** .....**ALL**  
Water Pump Adapter Plate For 55 & Up  
235, 261 Engines To Use Earlier 41-54  
Water Pumps 1.069 -0.15 ..... **\$49.00 EA**

**Water Pump Rebuild Service**

**REBUILDWP** .....**ALL**  
Rebuild service for your water pump. -0.3  
..... starting at **\$238.50 EA**

**Backing Plate Water Pump**



**838151** .....**37-40**  
Metal backing plate  
behind the water pump  
1.113 -0.15 .....  
**\$32.75 EA**

**Backing Plate Water Pump Gasket**



**383150** .....**37-40**  
Backing plate gasket  
1.114 -0.2 ..... **\$5.00 EA**



**839469** .....**41-54**  
Backing plate gasket  
1.114 -0.3 ..... **\$7.00 EA**

**Water Pump to Block Gasket**



**838137** .....**37-40**  
Water pump to block  
1.079 -0.2 ..... **\$5.75 EA**



**3836048** .....**41-54**  
Water pump to block  
1.079 -0.2 ..... **\$5.00 EA**

**Water Pump to Block Gasket, cont.**



**3836162** .....**55-61**  
Water pump to block.  
For water pump w/  
short pulley & shaft  
(part # 3741033 55 &  
later 235ci & 261ci engines) 1.069 -0.15  
..... **\$4.25 EA**

**Water Pump Pulley**



**3836804A** .....**53-54**  
Cast Iron pulley 3/8"  
belt 1.069 -0.2 .....  
**\$37.50 EA**

**Fan**



**838277** .....**37-54**  
Black finish fan blade. Fits 37-40 GA, HA,  
KH & 41-54 Passenger. 1.064 -0.15 .....  
**\$37.50 EA**

**Belt**



**3680776** .....**37-52**  
For fan & generator  
1.066 -0.15 ..... **\$24.00 EA**

**3703633** ..... **53-54**  
Power steering pump. 1.066 -0.2 .....  
**\$8.25 EA**

**3713313** ..... **53-54**  
For fan & generator 1.066 -0.15 ..... **\$7.00 EA**

**Odds And Ends**

Please call for availability on all Odds & Ends  
parts. Once part is sold, it may no longer be in  
stock.

**3114869T** .....**40-41**  
Radiator Top-(upper Tank), '40 -'41  
2.000 -0.4 ..... **\$65.00 EA**

**4114598U** .....**46-48**  
Cowl vent fits wagon Used 10.307 -0 .....  
**\$50.00 EA**

**3702022N** .....**49-50**  
Airflow ventilator (NOS) right side 9.810 -0  
..... **\$45.00 EA**

**3123756** .....**49-54**  
Upper Radiator Tank (NOS) harrison  
2.000 -0.4 ..... **\$85.00 EA**

**3701635** ..... **53**  
Radiator Grille Bar Center Support  
18.000 -0 ..... **\$25.00 EA**

**3702500** ..... **53**  
Radiator grille support NOS 1.266 -0.4 ...  
**\$8.00 EA**

**3705100** ..... **54**  
Radiator Grille Bar Center Support  
18.000 -0.4 ..... **\$25.00 EA**

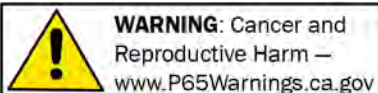

Chemicals shipped domestic ground only (Lower 48 states only). No international shipping.

**Phone: (360) 816-0211 • (800) 999-CHEV (2438) • www.chevsofthe40s.com**



**OLD AIR — Air Conditioning & Heating System — GREAT FOR 6-CYLINDER APPLICATIONS!**

**Complete Universal systems with everything you need to install Heat & Air Conditioning in your vehicle (minus refrigerant).** These Hurricane units are designed for efficiency and minimal use of space to allow for stereos, glove boxes, wiper motors, etc. Choose Hurricane unit with Upper, Lower or Side exit fittings (see dimensions below). System includes Sanden 508 Compressor (or equivalent), mounting brackets, Condenser (you'll need to measure your radiator), Receiver/ Drier, Binary Pressure Safety Switch, A/C & Heater Hose, Wire Harness, Clamps, 4 inch Vent Hose Kit, Control Panel w/ Knobs and more. Pick 4 vents to best suit your dash (some double vents count as 2). Optional items include Electronic Slide Controls (Vertical or Horizontal) in black or aluminum finish, Chrome Drier or Polished Compressor.

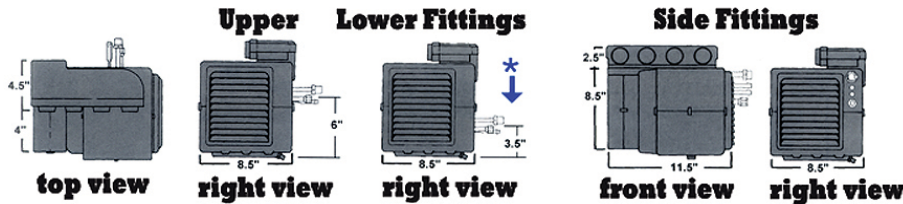

Condensers use flat tubes not round creating greater frontal area which equates to improved cooling.

The Heat & Defrost units for these systems mounts directly to your firewall. A/C & Heater lines pass through a custom rubber grommet that fits into the factory blower motor hole (shown below). Take a look at our In-Dash Vent and Switch kit below. These systems are designed for easy installation with custom condenser mounting, aluminum lines and step-by-step instructions. Retains cowl vent and majority of glove box. Has floor Heat and De-Humidified Defrost.



A little tight on defroster space for your HVAC unit? Just let your sales rep know that you want the 90 degree defroster outlet option. And hey, we won't even charge you for it.



90° Defrost Option  
Requires only 1-7/8" space above for duct hose routing, includes "Y" adapter.



Standard Defrost Outlets  
Allow 2-1/2" to 3" above for duct hose routing

**SECTION 035C  
STREET ROD PARTS**

**Air Conditioning And Heating System**











- AC1000C** ..... **ALL**  
Complete System with Upper HVAC fittings and Cable Controls. 9.779 -0.15 .....  
**\$1,266.00 SET** ⚠
- AC1100C** ..... **ALL**  
Complete System with Upper HVAC fittings and Electronic Controls. 9.779 -0.15 .....  
**\$1,366.25 SET** ⚠
- AC2000C** ..... **ALL**  
Complete System with 90-degree HVAC fittings and Cable Controls. 9.779 -0.15 .....  
**\$1,266.00 SET** ⚠
- AC2100C** ..... **ALL**  
Complete System with right side HVAC fittings and Electronic Controls. 9.779 -0.15 .....  
**\$1,376.00 SET** ⚠
- AC3000C** ..... **ALL**  
Complete System with Lower HVAC fittings and Cable Controls. 9.779 -0.15 .....  
**\$1,266.00 SET** ⚠
- AC3100C** ..... **ALL**  
Complete System with Lower HVAC fittings and Electronic Controls. 9.779 -0.15 .....  
**\$1,366.25 SET** ⚠

**Air Conditioning And Heating System Upgrade**

-  **ACDRIERUP** ..... **ALL**  
Chrome drier for air conditioning. With polished mounting bracket. 8" L x 2-1/2" dia. With sight glass. 9.779 -0.15 .....  
**\$78.00 EA** ⚠
-  **ACDVENT** ..... **ALL**  
Defroster vent. Replaces missing or worn vents. Plastic. 9.779 -0.15 .....  
**\$18.50 EA** ⚠
-  **ACPNL-E** ..... **ALL**  
Electronic controls. Smooth servo action. Available in Horizontal or Vertical cover plate and Brushed Aluminum or Black finish. 9.779 -0 .....  
.....starting at **\$85.00 EA** ⚠

**Air Conditioning System Vents**

Note: Choose the 4 vents that best fit your application: (VENT-3 and VENT-20 count as 2 vents). Vents included with A/C kits. Vents also sold separately.

-  **VENT-1** ..... **ALL**  
HVAC vent under dash, rectangular (2" x 6-1/4") . 9.779 -0.15 .....  
**\$15.50 EA** ⚠
-  **VENT-10** ..... **ALL**  
HVAC vents under dash, round corner. 9.779 -0.15 .....  
**\$36.50 PR** ⚠
-  **VENT-14** ..... **ALL**  
HVAC vents kick panel louvers (pair). 9.779 -0.15 .....  
**\$36.50 PR** ⚠
-  **VENT-2** ..... **ALL**  
HVAC vents under dash, round (3" x 4-1/2" ) . 9.779 -0.15 .....  
**\$16.00 EA** ⚠
-  **VENT-20** ..... **ALL**  
HVAC vents under dash, rectangular double vent (2" x 10" ), Counts as 2. 9.779 -0.15 .....  
**\$29.00 EA** ⚠
-  **VENT-21** ..... **ALL**  
HVAC vents in dash, rectangular (3-1/2" x 3-1/2" ) . 9.779 -0.15 .....  
**\$18.50 EA** ⚠
-  **VENT-3** ..... **ALL**  
HVAC vents under dash, rectangular double vent (2" x 11-1/2" ). Counts as 2. 9.779 -0.15 .....  
**\$29.00 EA** ⚠
-  **VENT-5** ..... **ALL**  
HVAC vents in dash, rectangular (1-3/8" x 4-3/4" ) . 9.779 -0.15 .....  
**\$16.00 EA** ⚠
-  **VENT-6** ..... **ALL**  
HVAC vents in dash, rectangular (1-3/8" x 3-3/4" ) . 9.779 -0.15 .....  
**\$16.00 EA** ⚠
-  **VENT-7** ..... **ALL**  
HVAC vents in dash, rectangular (2-3/4" x 2-1/2" ) . 9.779 -0.15 .....  
**\$16.00 EA** ⚠
-  **VENT-8** ..... **ALL**  
HVAC vents in dash, rectangular (2" x 5-1/4" ) . 9.779 -0.15 .....  
**\$16.00 EA** ⚠

**Universal Heater**



- 50515-VUH** ..... **ALL**  
GEN II COMPAC heater only with electronic servo controls & 3 speed fan. 9.779 -0.15 .....  
**\$273.75 EA** ⚠

**Universal Heater Defroster**



- 506101** ..... **ALL**  
GEN II COMPAC heater / defroster with electronic servo controls & 3 speed fan. 9.779 -0.15 .....  
**\$342.50 KIT** ⚠

**Fan**



- 40848** ..... **ALL**  
12 volt 6" steel blade heady duty fan. -0.15 .....  
**\$43.25 EA** ⚠

**Alternator And Compressor Brackets**

- 15273-VCB** ..... **37-54**  
1954 & earlier 216 & 235 Chev 6-cylinder. Single pulley. 9.779 -0.15 .....  
**\$208.50 SET** ⚠

**SECTION 035C  
RESTORATION PARTS**

**Heater Switch**



- 3112682B** . . . **ALL**  
Heater switch 6v, rotary rheostat, clamps to dash bottom. Variable speed. 8.852 -0.15 .....  
**\$19.75 EA** ⚠



**Heater Switch, cont.**



**3112682C.....ALL**  
 Heater switch 12v, rotary rheostat, clamps to dash bottom. 3 speed. 8.852-0.2 ..... **\$31.75 EA** ⚠️

**Heater Motor NOS**

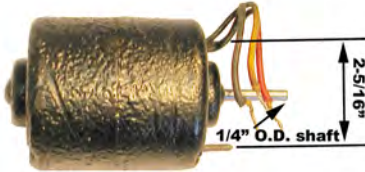

**5047730.....40-48**  
 Heater Motor 6v exc airflow (5-1/2 in. x 2-7/8 in. diameter) (NOS) 8.855-0 ... **CALL** ⚠️  
**5047730.....49-54**  
 Heater motor 6v exc. airflow (5-1/2 in. x 2-7/8 in. diameter) (NOS) 8.855-0 ... **CALL** ⚠️

**Heater & Defroster Motor**



**5047531.....37-54**  
 Heater/Defroster motor 6v replacement (5 in. x 2-3/4 in. diameter) 1-3/8 in. shaft, reversible. 8.855-0.15 .. **\$55.50 EA** ⚠️



**5047849.....37-54**  
 Heater/Defroster motor 12v replacement, (5 in. x 2-7/8 in. diameter) 1-1/2 in. shaft, reversible. 8.855-0.15 **\$109.25 EA** ⚠️

**Defroster Duct Hose**



**3119156R.....ALL**  
 Defroster duct hose 1-1/2 in. i.d. 36 in. length. Plastic replacement (original was cloth covered, wound wire) 9.779-0 ... **\$25.25 EA** ⚠️

**Defroster Duct Hose, cont.**

**3119719.....ALL**  
 Defroster duct hose 1-3/4 in. i.d. 36 in. length. Cloth covered. 9.779-0.15 ..... **\$27.50 EA** ⚠️  
**3125764.....ALL**  
 Defroster duct hose 2 in. i.d. 36 in. length. Cloth covered. 9.779-0.15 ..... **\$33.25 EA** ⚠️

**Heater Grommet**



**3691292A.....49-54**  
 Heater Hose Grommet For 5/8 in. heater hose (thru firewall) 8.846-0.15 ..... **\$6.25 PR** ⚠️

**Heater And Defroster Hose**



**3691292.....ALL**  
 Heater Hose Black, 5/8" I.D., 7/8" O.D. hose 8.846-0.2 ..... **\$3.75 FT** ⚠️

**Heater And Defroster Hose Clamps**



**432645.....ALL**  
 Heater Hose Clamps Fits 5/8" I.D. hose. Original (4 pcs) 1.166-0.2 ..... **\$6.50 SET** ⚠️

**Aluminum Bundle Straps**



**13196.....ALL**  
 .25" W X 4.05" L Used to bundle wires or hoses. -0.2 **\$4.00 EA** ⚠️



**13197.....ALL**  
 .25" W X 7.15" L Used to bundle wires or hoses -0.2 **\$5.00 EA** ⚠️

**Heater And Defroster Knob**

**604622.....41**  
 Heater door (Special Deluxe) ivory replacement 12.018-0.15 .. **\$14.00 EA** ⚠️

**Heater And Defroster Knob, cont.**



**3129274A.....51-52**  
 Heater/Defroster knobs - Temp, defrost, air, ivory (3) Original color and quality. 8.861-0.25 ..... **CALL** ⚠️

**Heater And Defroster Shutoff Valve**



**985533.....35-54**  
 Heater shutoff valve replacement, screws into water pump. For 5/8" hose. 8.870-0 ..... **\$45.00 EA** ⚠️

**Heater And Defroster Nipple**



**3106066.....29-54**  
 Heater/Defroster Nipple connects heater hose to engine. 8.866-0.2

**\$64.50 EA** ⚠️

**Heater Control Valve**

**3125537.....49-52**  
 Rebuild service using your core. (RANCO ONLY) 9.795-0.15 ..... **\$110.00 EA** ⚠️  
**3129491.....53-54**  
 Rebuild service using your core.(RANCO ONLY) 9.795-0.15 ..... **\$110.00 EA** ⚠️  
**3129491C.....53-54**  
 Rebuild service using your core.(RANCO ONLY) 9.795-0 ..... **\$124.75 EA** ⚠️

**Heater Control Valve Rebuild Kit**



**3128267C.....47-54**  
 Heater control valve rebuild kit, w/ instructions. 8.861-0.15 **\$17.00 EA** ⚠️

**Heater Core**



**3106035.....36-37**  
 Harrison standard round heater core. Designed to fit Harrison 172 housing. Made in USA! -0.15 ..... **\$299.25 EA** ⚠️



**Heater Core, cont.**



**3108712** ..... **38-42**  
Harrison model 143 round heater core.  
New, made in USA! -0.15 ... **\$449.00 EA**  
⚠️

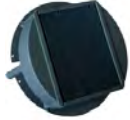

**3114410** ..... **40-41**  
Harrison deluxe heater core 112. Made in USA! -0.15 ..... **\$299.25 EA** ⚠️



**3118913** ..... **46-48**  
Heater core super deluxe new, made in USA! -0.15 ..... **\$299.25 EA** ⚠️

**Heater Core Rebuild**

Call for quote on all other heater core rebuilds including underseat heaters.

**3115605R** ..... **37-54**  
Rebuild your heater core 8.854 -0.15  
**CALL** ⚠️

**Seal Heater Motor**



**5047684A** ..... **49-54**  
Seal. Heater motor to firewall. 8.855 -0.15  
**\$9.00 EA** ⚠️

**Heater And Defroster Wiring Harness**



**3106048B** ... **37-49**  
Heater & defroster wiring harness  
8.853 -0 ..... **\$76.00 EA** ⚠️

**Fresh Air Vent**



**3688805** ..... **49-54**  
Rubber connector sleeve, fresh air duct  
9.786 -0.15 ..... **\$8.00 PR**  
⚠️



**3695657** ..... **49-54**  
Gaskets, fresh air inlet valve to cowl 9.810 -0.2  
..... **\$7.00 PR** ⚠️

**Fresh Air Vent Cable Assembly**



**1990701R** ..... **51-52**  
Knob, cable & bracket.  
Good condition.  
Original color and quality. 9.787 -0 **CALL**

**Fresh Air Vent Knob**



**1990701A** ..... **51-52**  
Knob Original color and quality. 9.787 -0 **CALL**  
⚠️

**Cowl Vent Knob**



**985603** ..... **39-48**  
Ivory accessory  
9.691 -0.25 .....  
**\$15.00 EA** ⚠️

**Cowl Vent Seal**



**4081958** ..... **37-48**  
Rubber 10.331 -0.15 ..... **\$24.50 EA** ⚠️

**Cowl Vent Drain Hose**



**4101941** ..... **37-48**  
Molded 10.344 -0.2 ..... **\$28.75 EA** ⚠️

**Heater Paint**



**604481P** ... **42-46**  
Heater beige hammer-tone (thin w/ enamel thinner).  
16.080 -0.15  
..... **\$110.00 QT** ⚠️

**Defroster Decal**



**DEC06** ..... **42-54**  
On/off defroster decal 19.200 -0.15  
..... **\$3.00 EA** ⚠️

**Heater Decal**



**DEC29** ..... **49-51**  
Decal-Harrison  
19.200 -0.15 .....  
**\$11.25 EA** ⚠️

**Heater Decal, cont.**



**DEC27** ..... **53-54**  
Decal 19.200 -0.15  
..... **\$7.75 EA** ⚠️

**Heater Operation Card**

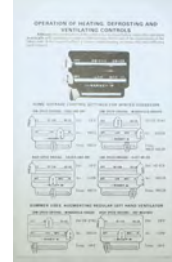

**TAG17** ..... **49-50**  
Operation card  
19.100 -0.15  
..... **\$9.00 EA** ⚠️



**TAG28** ..... **51-52**  
Operation card  
19.100 -0.15  
..... **\$9.00 EA** ⚠️

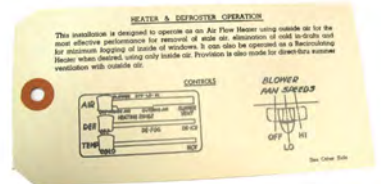

**TAG27** ..... **53-54**  
Operation card air flow heater 19.100 -0.15  
..... **\$4.99 EA** ⚠️

**Odds And Ends**

Please call for availability on all Odds & Ends parts. Once part is sold, it may no longer be in stock.

**604638** ..... **35-36**  
Accy. Heater Baffle For Super Deluxe Heater 2.000 -0.4 ..... **\$15.00 EA** ⚠️  
**986062** ..... **41-48**  
Heater- Deluxe used. Needs to be restored. (Needs correct name plate.)  
8.854 -0.4 ..... **\$250.00 EA** ⚠️

**986101** ..... **47-48**  
Heater w/ blower motor 8.845 -0.4 .....  
**\$500.00 EA** ⚠️  
**3688936** ..... **49-50**  
Air flow baffle, right NOS 12.803 -0.4 .....  
**\$65.00 EA** ⚠️

**3125537C** ..... **49-52**  
Heater control valve core. Needs rebuild  
9.795 -0.4 ..... **\$50.00 EA** ⚠️  
**3126680** ..... **51-52**  
Heater Control Head Without Knobs  
8.852 -0.4 ..... **\$45.00 EA** ⚠️

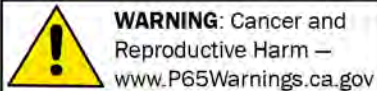

**WARNING: Cancer and Reproductive Harm** —  
www.P65Warnings.ca.gov

Chemicals shipped domestic ground only (Lower 48 states only). No international shipping.

Phone: (360) 816-0211 • (800) 999-CHEV (2438) • www.chevsofthe40s.com

035C





**SECTION 040C  
RESTORATION PARTS**

**Starter Switch**

**WKS1 .....37-54**

Electric switch kit when switching from foot operated starter (part # 1913369GR) -0.15



**\$55.75 EA** ⚠️

**820052A .....38-48**

For foot operated starter. 2.100 -0.3

**\$19.50 EA** ⚠️

**1996037 .....49-50**

Chrome button in dash. 2.100 -0.15

**\$49.00 EA** ⚠️

**1996055 .....50-52**

Chrome Button In Dash - Delco 2.100 -0.15

**\$50.00 EA** ⚠️

**Starter Pedal Return Spring**

**3654152 .....37-48**

Return spring 2.029 -0.15

**\$4.50 EA** ⚠️

**Starter Solenoid Boot**

**1912448 .....49-58**

This is the rubber boot for the starter solenoid plunger. 2.113 -0.15

**\$7.50 EA** ⚠️

**Starter Solenoid**

**1118135 .....49-54**

Also fits 53-55 Corvette (solenoid only) 2.100 -0.15

**\$80.00 EA** ⚠️



**Starter Solenoid Repair Kit**



**1118135A .....49-54**

Also fits 53-55 Corvette 2.100 -0

**\$25.00 EA** ⚠️

**1118135A .....54-55**

Double Duty & 54-55 Hydromatic 2.100 -0

**\$25.00 EA** ⚠️

**Insulator**



**1118135C .....49-64**

Molded, keeps solenoid cool. 2.100 -0.15

**\$16.75 EA** ⚠️

**Polarity Reverse Switch**

**1889827 .....41-42**

On starter, w/ 1 in. x 1-1/2 in. base (NOS) 2.117 -0.4

**\$55.00 EA** ⚠️



**1907122 .....46-48**

On starter (NOS) 2.117 -0.4

**\$44.00 EA** ⚠️



**Polarity Reverse Switch Wiring Harness**

**1881929 .....41-48**

Wiring harness for reverse polarity switch. 2.122 -0.15

**\$43.75 EA** ⚠️



**Engine Crank**



**3661378 .....37-47**

If you have the muscles, this is the ultimate starter. Manual start. Hardened steel reproduction. 0.239 -0

**\$63.00 EA** ⚠️

**Starter**



**1107108 .....38-48**

6 volt Foot operated (\$50 core) 2.041 -0.15

**\$199.00 EA** ⚠️

**1107108C .....38-48**

12 volt, foot operated (\$50 core) 2.041 -0

**\$250.00 EA** ⚠️

**Starter, cont.**



**1913369 .....49-54**

Rebuilt 6 volt. Uses solenoid (\$100 core). Fits Passenger & DUBL-DUTI Trucks.

2.041 -0.15 **\$229.75 EA** ⚠️

**1913369C .....49-54**

Rebuilt 12 volt. Uses solenoid (\$100 core). Fits Passenger & DUBL-DUTI Trucks.

2.041 -0 **\$249.75 EA** ⚠️



**1913369GR .....ALL**

High torque gear reduction starter. Built in solenoid 12v, fits 139 tooth Flywheel. Has multiple mounting positions. -0.15

**\$349.00 EA** ⚠️

**Starter Rebuild Service**

**1864489 .....37-54**

Rebuild yours 2.041 -0.15 **\$185.00 EA**

**Starter Rebuild Kit**



**1900558 .....37-54**

W/ brushes, springs, bushing (29 pcs). For 1937 needs 810620 bushing. 2.053 -0.1

**\$75.00 KIT** ⚠️

**Starter Drive**

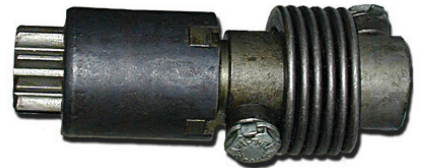

**1859020 .....34-37**

Starter drive assembly 2.086 -0.15

**\$89.99 EA** ⚠️

**2873789 .....38-54**

Starter drive assembly. 9T 2.086 -0.15

**\$28.00 EA** ⚠️

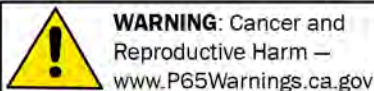

**WARNING: Cancer and Reproductive Harm** — www.P65Warnings.ca.gov

Chemicals shipped domestic ground only (Lower 48 states only). No international shipping.

**Phone: (360) 816-0211 • (800) 999-CHEV (2438) • www.chevsofthe40s.com**



**Starter Brush Set**



**811553.....25-54**  
Set of 4 2.051 -0.3  
**\$5.00 SET** ⚠

**Starter Bushing**



**810620.....29-37**  
Drive end 2.083 -0.4  
**\$2.50 EA** ⚠



**1839345.....38-54**  
Drive end 2.083 -0.4  
**\$2.50 EA** ⚠



**810620A.....38-54**  
Non-drive end 2.083 -0.4  
**\$2.50 EA** ⚠

**Starter Band**



**817114.....29-54**  
Covers openings on starter. 2.070 -0.4  
**\$9.50 EA** ⚠

**Delco Remy Metal Tag**



**PLATE07.....37**  
Generator, starter & distributor 19.400 -0.15  
**\$7.00 EA** ⚠



**PLATE05.....38-54**  
Generator, Starter or Distributor. Includes rivets. 19.400 -0.15  
**\$7.00 EA** ⚠

**Starter Oiler**



**114998.....29-54**  
Hinged lid. 5/16 in.  
o.d. insert. 2.305 -0.15  
**\$22.00 EA** ⚠

**Odds And Ends**

Please call for availability on all Odds & Ends parts. Once part is sold, it may no longer be in stock.

**813550.....25-37**

Commutator end frame 25-37 Chevy.  
26-29, 33-34 Pontiac 2.067 -0.4 .....  
**\$15.00 EA** ⚠

**598070.....38-50**

Clip-Starter Lever Pull Back 2.108 -0 .....  
**\$7.50 EA** ⚠

**1908580.....50-54**

Starter Commutator End Frame, Pass  
3.000 -0.4 ..... **\$15.00 EA** ⚠

**1873789.....50-56**

Starter drive (NOS) 12V fits Corvette  
1.053 -0 ..... **\$30.00 EA** ⚠

**1952563.....51-56**

Starter Solenoid Contact, Buick 3.000 -0.3  
..... **\$4.00 EA** ⚠

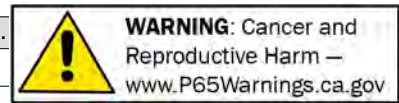

**SECTION 045C  
STREET ROD PARTS**

**Battery Jump Starter**



**GB40.....ALL**  
Compact, yet powerful 1,000 Amp lithium-ion jump starter that delivers 7,000 Joules of starting power. Its patented safety technology features spark-proof technology and reverse polarity protection making it safe for anyone to use. Designed for use with gas engines up to 6 liters and diesel engines up to 3 liters and doubles as a portable power source for recharging smartphones, tablets and more. -0.15

**\$125.00 EA** ⚠️



**GB70.....ALL**  
The GB70 is a portable lithium-ion battery jump starter pack that delivers 2,000-amps (15,700 J3S) for jump starting a dead battery in seconds. It features a patented safety technology that provides spark-proof connections and reverse polarity protection making safe and easy for anyone to use. It's a powerful battery booster that doubles as a portable power source for recharging USB devices, like a smartphone, tablet and more, or powering 12-volt devices, like a tire inflator, power inverter and much more. And designed for a car, boat, RV, truck and more with gas engines up to 8 liters, and diesel engines up to 6 liters. -0.15

**\$250.75 EA** ⚠️

**12 Volt Conversion Kits**



**12VKIT03....37-54**  
Includes 100 amp alternator with 5/8" pulley, bracket & hardware, 10 AWG charge wire, coil, horn relay, headlight

relay, fuel gauge voltage reducer, instructions. -0.15

**\$525.50 EA** ⚠️

**12 Volt Conversion Kits, cont.**



**12VKIT04....37-54**  
Includes 100 amp alternator with 3/8" pulley, bracket & hardware, 10 AWG charge wire, coil, horn relay, headlight

relay, fuel gauge voltage reducer, instructions. -0.15

**\$504.00 EA** ⚠️



**12VKIT06....37-54**  
Includes 63 amp alternator with 3/8" pulley, bracket & hardware, 10 AWG charge wire, coil, starter solenoid,

horn relay, headlight relay, fuel gauge voltage reducer, instructions. -0

**CALL** ⚠️



**12VKIT07....37-54**  
Includes 100 amp alternator with 5/8" pulley, bracket & hardware, 10 AWG charge wire, coil, starter solenoid,

horn relay, headlight relay, fuel gauge voltage reducer, instructions. -0.15

**\$476.00 EA** ⚠️



**12VKIT08....37-54**  
Includes 100 amp alternator with 3/8" pulley, bracket & hardware, 10 AWG charge wire, coil, starter solenoid,

horn relay, headlight relay, fuel gauge voltage reducer, instructions. -0.15

**\$476.00 EA** ⚠️

**Alternator**



**89502C.....ALL**  
6v-60 amp, 7.5v show chrome housing, 3/8" 2 groove pulley, internally regulated, comes w/ D.A. plug, uses original wiring,

new. 2.275 -0

**\$296.50 EA** ⚠️



**89502S.....ALL**  
6v-60 amp, 7.5v internally regulated, single groove 3/8" pulley. †(Rebuilt) 2.275 -0.15

**\$168.00 EA** ⚠️

**Alternator, cont.**



**905021.....ALL**  
10SI 12v, 63 Amp Internally Regulated With 3/8 "Pulley -0.15  
..... **\$180.25 EA** ⚠️



**905022.....ALL**  
CS130 12v, 100 Amp Internally Regulated With 3/8 "Pulley -0.15  
..... **\$195.50 EA** ⚠️



**905023.....ALL**  
10SI 12v 63 amp, Chrome Internally Regulated 1-Wire With 3/8 "Pulley -0.15  
..... **\$166.00 EA** ⚠️



**905024.....ALL**  
10SI 12v 100 amp, Chrome Internally Regulated 1-Wire With 5/8 "Pulley -0.15  
..... **\$197.25 EA** ⚠️



**90502S.....ALL**  
12v-60 amp, 14v internally regulated, simple two wire hookup, replace any 12v generator, comes with D.A. plug, new. 2.275 -0.15

**\$326.50 EA** ⚠️

**PowerGen**



**82051.....ALL**  
Powermaster-PowerGen GM Long (90A,12V) Black -0.15  
..... **\$446.75 EA** ⚠️



**82057.....ALL**  
Powermaster-PowerGen GM Long (60A,6V Neg Ground) Black -0.15  
..... **\$457.75 EA** ⚠️



**82111.....ALL**  
Powermaster-PowerGen GM Short (90A,12v) Black 2.275 -0.15  
..... **\$446.75 EA** ⚠️



**82117.....ALL**  
Powermaster-PowerGen GM Short (60A,6V Neg Ground ) Black -0.15  
..... **\$457.75 EA** ⚠️

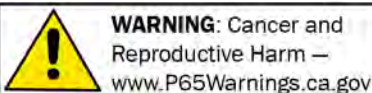

**WARNING: Cancer and Reproductive Harm** —  
www.P65Warnings.ca.gov

Chemicals shipped domestic ground only (Lower 48 states only). No international shipping.

**Phone: (360) 816-0211 • (800) 999-CHEV (2438) • www.chevsofthe40s.com**

045C

# Section 045C: Alternators, Generators, Voltage Regulators, Batteries, Battery Trays & Battery Cables

## Alternator Pulley



**90502WP . . . . .37-52**  
Fits 5/8 in. belt.  
2.274 -0.15 . . . . .

**\$40.00 EA** ⚠



**89502P . . . . .ALL**  
3/8" 2 groove.  
2.274 -0.15 . . . . .

**\$37.50 EA** ⚠

## Mount Bracket



**839446B . . . . .37-55**  
Universal alternator bracket. 2.277 -0.15

**\$103.50 EA** ⚠



**839446D . . . . .37-55**  
Alternator bracket. Mounting hardware included. 2.277 -0.2 . . . . .

**\$76.00 KIT** ⚠



**3714376B . . . . .55-62**  
Alternator bracket (12v or 6v alt. 55-62 requires narrow pulley pump & 53-up crank pulley). Mounting hardware included. 2.277 -0.2 . . . . .

**\$76.00 EA** ⚠

## D.A. Plug



**89502 . . . . .ALL**  
Connects 6v or 12v alternator to original wiring. 2.275 -0.15 . . . . .

**\$36.75 EA** ⚠



**SECTION 045C  
RESTORATION PARTS**

**Genius Battery Chargers**



**GENIUS10.....ALL**  
most powerful, highest-performing, energy-efficient, and compact chargers yet. The

GENIUS5 is a 6-volt and 12-volt battery charger, battery maintainer, and battery desulfator rated at 10-amps for lead-acid automotive, marine, and deep-cycle batteries, including flooded, gel, AGM, and maintenance-free, plus lithium-ion batteries. -0 .. **\$125.00 EA** ⚠

**GENIUS2.....ALL**  
most powerful, highest-performing, energy-efficient, and compact chargers yet. The GENIUS2 is a 6-volt and 12-volt battery charger, battery maintainer, and battery desulfator rated at 2-amps for lead-acid automotive, marine, and deep-cycle batteries, including flooded, gel, AGM, and maintenance-free, plus lithium-ion batteries. -0 .. **\$65.00 EA** ⚠

**GENIUS5.....ALL**  
most powerful, highest-performing, energy-efficient, and compact chargers yet. The GENIUS5 is a 6-volt and 12-volt battery charger, battery maintainer, and battery desulfator rated at 5-amps for lead-acid automotive, marine, and deep-cycle batteries, including flooded, gel, AGM, and maintenance-free, plus lithium-ion batteries. -0 .. **\$90.00 EA** ⚠

**Battery Terminal Cleaner**

**10653CLNR ...ALL**  
Battery top post cleaner -0.15  
..... **\$12.00 EA** ⚠



**Generator**



**1102744.....40-52**  
Rebuilt 10-1/2 in. long, 6v (\$75 core) - 5/8 in. belt pulley. To determine your generator size measure all the way to end of pulley. 2.275 -0.15 ... **\$194.75 EA** ⚠

**Generator, cont.**



**1100024.....52-54**  
Rebuilt 9-1/2 in. long, 6v (\$75 core). Narrow belt pulley. To determine your generator size measure all the way to the end of pulley. 2.275 -0.15 ... **\$194.75 EA** ⚠

**Generator Rebuild Service**

**1100502.....29-54**  
Rebuild service for your generator 2.275 -0.15 ..... **\$195.00 EA** ⚠

**Generator Rebuild Kit**



**597667.....35-52**  
Pulley 5/8" belt 2.274 -0.2 **\$39.50 EA** ⚠



**1901243.....40-54**  
W/ brushes, gaskets, etc. (41 pcs). Pulley end bearing #954378 not included. 2.286 -0 ..... **CALL** ⚠

**Generator Brush Set**



**1857963.....37-39**  
3 pieces 2.285 -0.2 **\$16.00 SET** ⚠  
**1878209.....40-54**  
2 pieces 2.285 -0.3 **\$9.25 SET** ⚠

**Generator Bearing**



**954378.....29-57**  
Pulley end 2.306 -0.2 ..... **\$7.50 EA** ⚠



**954685.....53-57**  
Commutator end 2.298 -0.15 ..... **\$12.00 EA** ⚠

**Generator Bushing**



**812823.....29-48**  
Commutator end 2.298 -0 ... **CALL** ⚠



**812824.....49-52**  
Commutator end 2.298 -0.4 . **\$3.50 EA** ⚠

**Generator Oiler**



**816341.....29-54**  
Metal, as original. 3/16 in. o.d. insert 2.305 -0.15 ..... **\$6.00 EA** ⚠

**Generator Band**



**816340.....29-52**  
Covers opening in generator. 2.299 -0.3 **\$8.50 EA** ⚠

**Generator Bolt And Nut**



**3682642B.....37-54**  
Set (generator to motor) 2.277 -0.15 ..... **\$5.25 SET** ⚠

**Delco Remy Metal Tag**



**PLATE07.....37**  
Generator, starter & distributor 19.400 -0.15 ..... **\$7.00 EA** ⚠



**PLATE05.....38-54**  
Generator, Starter or Distributor. Includes rivets. 19.400 -0.15 ..... **\$7.00 EA** ⚠

**Drive Belts**



**3680776.....37-52**  
For fan & generator 1.066 -0.15 .....

**\$24.00 EA** ⚠  
**3703633.....53-54**  
Power steering pump. 1.066 -0.2 .....

**\$8.25 EA** ⚠  
**3713313.....53-54**  
For fan & generator 1.066 -0.15 **\$7.00 EA** ⚠

**Voltage Cut Out**



**1867781.....29-39**  
Car and truck except COE 2.319 -0.2 ..... **\$85.00 EA** ⚠

**Voltage Regulator**



**1118301A.....40-52**  
35 Amp 6 Volt 2.500 -0.15 ..... **\$265.75 EA** ⚠

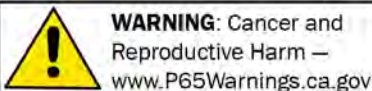

**WARNING: Cancer and Reproductive Harm —**  
www.P65Warnings.ca.gov

Chemicals shipped domestic ground only (Lower 48 states only). No international shipping.

Phone: (360) 816-0211 • (800) 999-CHEV (2438) • www.chevsofthe40s.com

045C

# Section 045C: Alternators, Generators, Voltage Regulators, Batteries, Battery Trays & Battery Cables

## Voltage Regulator, cont.



**1118331**.....**53-54**  
45 Amp 6 Volt  
2.500 -0.15 .....  
**\$138.00 EA** ⚠️

## Ground Strap



**529404A** .....**29-54**  
13in. 2.341 -0.15 ..... **\$18.00 EA** ⚠️



**529404N** .....**29-54**  
13in. NOS 2.341 -0 ..... **\$25.00 EA** ⚠️  
**1878280A** ..... **40-48**  
16-1/2in. replacement. 2.341 -0.15 .....  
**\$24.00 EA** ⚠️

## Battery Cable Positive



**1854073** .....**29-36**  
Original cloth cover (exc EC, FC) 25-1/4in.  
2.342 -0 ..... **\$50.00 EA** ⚠️  
**5288946** .....**37-54**  
Exc 40-48 39-1/2in. 1/0 Wire 2.342 -0  
..... **\$57.00 EA** ⚠️  
**5288944** .....**40-48**  
14in. 2.342 -0.15 ..... **\$34.75 EA** ⚠️

## Battery Mat



**3686708B** .....**ALL**  
Anti-corrosion pad to protect your battery  
tray. 7 3/4" X 12" x 1/8" thick. 2.333 -0.3  
..... **\$15.25 EA** ⚠️

## Battery Hold Down



**3653224B** .....**40-48**  
W/ bolts 2.335 -0.15 .. **\$21.50 SET** ⚠️

## Battery Hold Down, cont.



**3653224C** .....**49-54**  
W/ J-hooks 2.335 -0.15 ..... **\$21.00 SET** ⚠️



**3653224A** .....**ALL**  
Adjustable for 9-3/16" X 7-3/16", 10-3/4"  
X 7-3/16" batteries -0.3 .. **\$16.25 EA**  
⚠️

## Battery Cover



**354120** .....**29-36**  
Inspection cover in floor 16.547 -0.15  
..... **\$19.75 EA** ⚠️



**597973A** .....**37-39**  
Seal for battery  
inspection cover in floor.  
12.541 -0.15 .....  
**\$43.50 EA** ⚠️

## Battery Tray



**593779** .....**37-39**  
Superb reproduction 2.333 -0.2 .....  
**\$57.25 EA** ⚠️

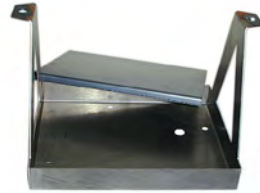

**3653225R** .....**40-48**  
Replacement (not original) 2.333 -0.15  
..... **\$54.75 EA** ⚠️

## Battery Tray, cont.



**3700058** .....**49-54**  
Superb 2.333 -0.15 ..... **\$36.00 EA** ⚠️

## Battery Tray Paint



**12998** .....**ALL**  
Battery tray  
Corrosion resistant,  
black (12 oz spray).  
8.800 -0.15  
..... **\$15.00 EA** ⚠️

## Odds And Ends

Please call for availability on all Odds & Ends parts. Once part is sold, it may no longer be in stock.

**1873956** .....**35-39**  
Generator Brush Plate (NOS) 2.287 -0.4 ..  
**\$30.00 EA** ⚠️  
**00940** .....**52-54**  
Battery Filler Cap Accessory. Save A  
Battery 2.332 -0.4 ..... **\$35.00 SET** ⚠️  
**00991** .....**57**  
Generator 12 volt rebuilt 3.000 -0.3 .....  
**\$200.00 EA** ⚠️  
**806915** .....**ALL**  
Nut for Generator amature- Fits CORVAIR  
2.280 -0.4 ..... **\$0.50 EA** ⚠️





**SECTION 050C  
STREET ROD PARTS**

**Pertronix Electronic Ignition System**

Delivers twice the voltage to the spark plugs, increasing horsepower, fuel economy, and spark plug life.

2:1 improvement over "points" in current fall time for increased coil output.

Rotating cobalt magnets trigger a Hall Effect integrated circuit, no points to burn, no moving parts to wear out.

Epoxy molding makes our module impervious to dirt, oil, grease and moisture.

Stable timing, no need for any adjustments. Will fit entirely inside the distributor (part #1112362 & 1112358). Simple and easy to install.



**1112362E12** ..... **40-53**  
Chevy 6cyl. 12v. 2.384 -0.15 .....

**\$188.25 SET** ⚠

**1112362E6** ..... **40-53**  
Chevy 6cyl. 6v. 2.384 -0 .. **\$179.00 SET**

**1112388E12** ..... **54-62**  
Chevy 6cyl. 12v. 2.384 -0.15 .....

**\$194.75 EA** ⚠

**1112388E6** ..... **54-62**  
Chevy 6cyl. 6v. 2.384 -0.15 .. **\$193.75 EA**

**Ignition Coil Pertronix 6 Volt**



**PER40001** ..... **ALL**  
6 Volt Chrome. 1.5 Ohm primary resistance.  
2.384 -0.15 .....

**\$76.00 EA** ⚠



**PER40011** ..... **ALL**  
6 Volt Black. 1.5 Ohm primary resistance.  
2.384 -0.15 .....

**\$55.75 EA** ⚠

**Ignition Coil Pertronix 12 Volt**



**PER40501** ..... **ALL**  
12 Volt Chrome. 3.0 Ohm primary resistance.  
2.384 -0.15 .....

**\$78.50 EA** ⚠



**PER40511** ..... **ALL**  
12 Volt Black. 3.0 Ohm primary resistance.  
2.384 -0.15 .....

**\$69.00 EA** ⚠

**Spark Plug Wires HEI Distributors**



**PEDC9066-E** ..... **ALL**  
Chevy in-line 6 cyl.,  
Black 0.000 -0.15 ..

**\$118.75 SET** ⚠

**Wire Looms**



**5298107L** ..... **ALL**  
Chrome. Fits 216ci, 235ci. 0.000 -0.15 ..

**\$38.75 SET** ⚠

**Distributor**



**PED62720** ..... **ALL**  
Chevy 6cyl 1949-62  
216,235,261ci. DUI  
electronic Distributor  
50,000 volt coil &  
Dyna-Module allows  
wider plug gaps  
& instant throttle  
response. 0.000 -0.15

**\$414.00 EA** ⚠

**Ballast Resistor**



**1931614** ..... **ALL**  
For 12v (coil). 2.173 -0.2 .. **\$16.00 EA** ⚠

**SECTION 050C  
RESTORATION PARTS**

**Spark Plug Wires**

**VPW2B** ..... **ALL**  
These are Vintage cloth wrapped black  
spark plug wires with 90 degree spark  
plug boots. -0.15 .....

**\$69.00 SET** ⚠

**Spark Plugs**



**1559494** ..... **33-54**  
Genuine AC 14 mm plug  
(exc 41-48) (6 pcs)  
2.270 -0.15 .....

**\$31.25 SET** ⚠



**1559459** ..... **41-48**  
Genuine AC 10 mm plug  
(6 pcs) 2.270 -0.15 ..

**\$31.25 SET** ⚠

**Spark Plug Wire O Rings**



**3652191** ..... **29-59**  
Rubber, holds plug  
wires. 1-5/16 in. o.d.,  
3/4 in. i.d. 2.251 -0.4 ..

**\$2.50 SET** ⚠

**Spark Plug Wire Set**



**5298107** ..... **34-54**  
Superb reproduction w/ GM stamped on  
metal ends. Copper core. 2.239 -0.15 ..

**\$46.25 SET** ⚠

**Ignition Coil**

**1115380** ..... **47-54**  
6v, Delco (NOS) 2.170 -0 .. **CALL** ⚠



**1115380A** ..... **47-54**  
6v, replacement 2.170 -0.2 .. **\$56.75 EA**

⚠



**1115091** ..... **47-59**  
12v, Replacement 2.170 -0.15 .....

**\$32.75 EA** ⚠

**Distributor**



**1112362** ..... **40-53**  
Exc 53 powerglide  
(\$40 core) 2.361 -0.2 ..

**\$175.00 EA** ⚠

**1112358** ..... **53-57**  
Exc 53 stick shift (\$35 core) 2.361 -0.3 ..

**\$227.50 EA** ⚠

**Distributor Cap**



**824735** ..... **33-53**  
Except 53 235ci  
2.364 -0.15 .....

**\$23.00 EA** ⚠



**1924248** ..... **53-57**  
With 235ci, 261ci  
2.367 -0.15 .....

**\$30.50 EA** ⚠

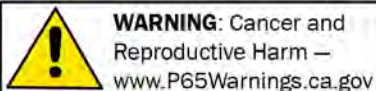

**WARNING: Cancer and Reproductive Harm** —  
www.P65Warnings.ca.gov

Chemicals shipped domestic ground only (Lower 48 states only). No international shipping.

**Phone: (360) 816-0211 • (800) 999-CHEV (2438) • www.chevsofthe40s.com**

050C



**Rotor**



**820445.....33-52**  
All exc CC, DC & 53  
235ci 2.382-0.15 .....  
**\$9.75 EA** ⚠️  
**1924245.....53-57**  
All, exc 53 216ci  
2.382-0.2 ... **\$6.00 EA**  
⚠️

**Points**

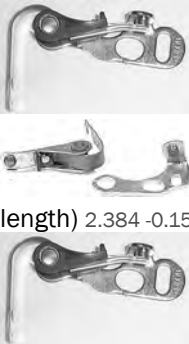

**1855720.....33-40**  
2-1/8 in. overall length  
2.384-0.15 .....  
**\$12.50 SET** ⚠️  
**1882391.....41-48**  
With polarity reversing  
switch (1-3/4 in. overall  
length) 2.384-0.15 .....  
**\$15.50 SET** ⚠️  
**1855720.....48-53**  
All (exc 48 w/ polarity  
reversing switch & 53  
235ci) 2-1/8 in. overall  
length. 2.384-0.15 ...

**\$12.25 SET** ⚠️



**1924571....53-57**  
All (exc 216ci)  
2-3/16 in. overall  
length. 2.384-0.15  
..... **\$16.00 SET** ⚠️

**Condenser**



**1928111.....37-54**  
Ignition 2.393-0.15  
**\$9.00 EA** ⚠️

**Hold Down Screw**



**816784.....ALL**  
Condenser & points  
2.387-0.4 **\$1.50 EA**  
⚠️

**Polarity Reverse Switch**



**1889827....41-42**  
On starter, w/ 1 in. x  
1-1/2 in. base (NOS)  
2.117-0.4  
..... **\$55.00 EA** ⚠️  
**1907122....46-48**  
On starter (NOS)  
2.117-0.4  
..... **\$44.00 EA** ⚠️

**Polarity Reverse Switch Wiring Harness**



**1881929....41-48**  
Wiring harness for  
reverse polarity  
switch. 2.122-0.15  
..... **\$43.75 EA** ⚠️

**Delco Remy Metal Tag**



**PLATE07.....37**  
Generator, starter & distributor 19.400-0.15  
..... **\$7.00 EA** ⚠️



**PLATE05.....38-54**  
Generator, Starter or Distributor. Includes  
rivets. 19.400-0.15 ..... **\$7.00 EA** ⚠️

**Timing Hole Plug**



**836802A.....ALL**  
Rubber (rare) 0.714-0.15  
..... **\$10.75 EA** ⚠️

**Vacuum Advance**

\$10 shipping & handling fee for rebuild service



**1116076R.....37-54**  
Rebuild service (we rebuild your core)  
2.410-0.15 ..... **\$50.00 EA** ⚠️

**1909343A.....39-51**  
W/ bracket & timing  
mark 90 degrees to  
vacuum chamber  
2.410-0.15 .....  
**\$38.00 EA** ⚠️

**1116076.....53-54**  
All 6 cylinders.  
2.410-0.15 .....  
**\$49.50 EA** ⚠️

**Ignition Switch**

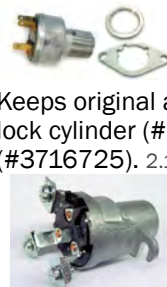

**1116452.....40-50**  
Switch with "Start" &  
"Accessory" positions.  
Keeps original appearance. Use with GM  
lock cylinder (#1458180) on '49-'57 cars  
(#3716725). 2.188-0 ..... **\$44.00 EA** ⚠️

**1116452D.....49-50**  
Reproduction. Bolts in  
as original. Screw  
terminal. Foot starter &  
push button only.  
2.188-0.15 ..... **\$41.75 EA** ⚠️

**1116469D.....51-52**  
As original for 1951-52  
car (no accessory  
position). Fits 1954-55  
(1st Series) Chevy truck also. 2.188-0.15  
..... **\$52.50 EA** ⚠️

**1116469.....51-57**  
Perfect fit 51-52  
(original 53-57), w/  
"Start" (6v or 12v).  
Uses GM lock cylinder (#3716725) &  
bezel (#1930492). 2.188-0.15 .....  
**\$48.75 EA** ⚠️



**1116452A.....ALL**  
Using a fork lift ignition switch? Use our  
flush mount switch w/ mounting bracket.  
Keep original appearance use lock  
cylinder #1458180 or #3716725  
(including keys). 2.188-0 ..... **\$45.00 SET**  
⚠️

**Ignition Switch Mounting Plate**

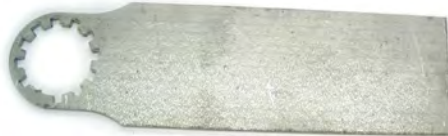

**3688155.....ALL**  
Universal mounting plate conforms to your  
dash to mount your switch (cylinder not  
included). 2.192-0.3 ..... **\$10.25 EA** ⚠️

**Ignition Switch Bezel**



**1930492.....51-54**  
Chrome nut 2.198-0.15  
..... **\$11.50 EA** ⚠️

**3707716.....53-54**  
Plastic 2.198-0.15  
..... **\$31.75 EA** ⚠️

**Section 055C: Steering Wheels, Horns & Related**

**Ignition Lock**

**1458180.....35-47**  
Cylinder & non-GM keys. Exc 48-57 Passenger. 2.188 -0.15



**\$13.00 EA** ⚠️

**3716725.....48-57**  
Cylinder & non-GM keys. 2.188 -0.15



**\$17.75 EA** ⚠️

**Key Blank**

**601272.....35-54**  
Original GM round head. Fits trunk, glove box & locking gas cap 2.187 -0.2 **\$5.25 EA**



**3694624.....35-57**  
Original GM octagon head. Fits ignition, door & spare tire locks. 2.187 -0.15 **\$3.75 EA** ⚠️



**\$3.75 EA** ⚠️

**Odds And Ends**

Please call for availability on all Odds & Ends parts. Once part is sold, it may no longer be in stock.

**1853749U.....33-34**  
Electric lock cable (no key cylinder) 2.188 -0.4 **\$50.00 EA** ⚠️

**1847432.....34-37**  
Armature (Starter) All exc Dc 2.279 -0.4 **\$42.00 EA** ⚠️

**1861895U.....36-39**  
Headlight knob (black) w/ shaft. Original color and quality. 2.486 -0 **\$5.50 EA** ⚠️

**1716076U.....37-54**  
Vacuum advance (Used) 2.410 -0 **\$25.00 EA** ⚠️

**1855520.....39-48**  
Points 6.168 -0.4 **\$15.00 EA** ⚠️

**1112362U.....40-53**  
Distributor with points and cond (Used). 2.361 -0.4 **\$75.00 EA** ⚠️

**1559459N.....41-48**  
Spark Plugs. 10mm (NORS) 2.270 -0.15 **\$2.75 EA** ⚠️

**3691803N.....50-52**  
Washer (NOS)-Starter over rear thrust. 4.117 -0.4 **\$5.00 EA** ⚠️

**1112363.....51-52**  
Distributor, w/o contact plate (NOS) 2.361 -0.4 **\$75.00 EA** ⚠️

**1916806.....51-53**  
Distributor stud 2.400 -0.15 **\$2.00 EA** ⚠️

**1119760R.....57**  
Starter solenoid Delco 2.100 -0 **\$30.00 EA** ⚠️

**1869573.....57**  
Bracket, Holds Condenser 8cyl Use w/ # 1112330 (NOS) 2.393 -0.15 **\$2.00 EA** ⚠️

**5559697.....ALL**  
Spark Plug, M-8, 84ts, 85ts, 104 3.000 -0.2 **\$3.00 EA** ⚠️

**SECTION 055C STREET ROD PARTS**

**Horn**



**46128.....ALL**  
Wolf Whistle. Designed as Original. Works Reliably. Die Cast Metal with all Metal Hardware.

Classic Wolf Sound. Has Strong Vacuum Hose and Instructions. -0.15 **\$90.00 EA** ⚠️



**HORN3.....ALL**  
Ooogah horn. Heavy duty 12 volt motor. Easy installation. Limited

lifetime warranty. 2.810 -0.2 **\$46.00 EA** ⚠️

**Horns**



**9000518.....40-54**  
W/ relay, 12v (pair). 2.810 -0.15 **\$69.00 SET** ⚠️

**SECTION 055C RESTORATION PARTS**

**Steering Wheel**



**986545B.....50-52**  
Accessory. Black, "butterfly" horn ring wheel. Originally used on 50-52 cars but will

fit multiple year spans from 1940 up. Horn button not like original. 6.513 -0.15 **\$352.75 EA** ⚠️



**986545W.....50-52**  
Accessory. White, "butterfly" horn ring wheel. Originally used on 50-52 cars but

will fit multiple year spans from 1940 up. Horn button not like original. 6.513 -0.15 **\$352.75 EA** ⚠️

**759205.....53**  
Bel Air Black With Unpainted Horn Button 6.513 -0.15 **\$363.50 EA** ⚠️



**759206.....54**  
Bel Air Black With Unpainted Horn Button 6.513 -0.15 **\$363.50 EA** ⚠️

**Spinner Steering Wheel Center Bar**



**985575PM.....40**  
Maroon. Behind horn bar. 6.513 -0.15 **\$175.00 EA** ⚠️



**985575PT.....40**  
Tan horn bar. 6.513 -0.15 **\$175.00 EA** ⚠️

**Spinner Steering Wheel Grips**



**985575GM.....40**  
Maroon 6.513 -0.15 **\$112.00 EA** ⚠️



**985575GT.....40**  
Tan. 6.513 -0.15 **\$112.25 PR** ⚠️



**Horn Bar**



**753880B.....40**  
Chrome for spinner wheel. 2.830 -0 **CALL** ⚠️

**Cup & Retainer (Spinner Steering Wheel)**



**753878B.....40**  
Superb reproduction. Brushed aluminum. 2.821 -0 **CALL** ⚠️



**754165B.....41**  
Superb reproduction. Brushed aluminum. 2.821 -0 **CALL** ⚠️

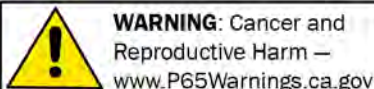

**WARNING: Cancer and Reproductive Harm** — www.P65Warnings.ca.gov

Chemicals shipped domestic ground only (Lower 48 states only). No international shipping.

**Phone: (360) 816-0211 • (800) 999-CHEV (2438) • www.chevsofthe40s.com**

055C



**Horn Ring**



**754061 . . . . .41-48**  
 Chrome 2.830 -0  
 . . . . . **CALL** ⚠



**986005R . . . . .42-48**  
 Accessory for banjo wheel. 11-1/8" OD with 3 wide flat spokes. Horn button not included. 2.830 -0



**756855 . . . . .49-50**  
 Fits two spoke steering wheel 2.830 -0.15  
 . . . . . **\$114.75 EA** ⚠

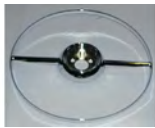

**754475 . . . . .53-54**  
 This is the chrome horn ring for 53-54 cars. 2.830 -0.15  
 . . . . . **\$83.75 EA** ⚠

**Horn Button**



**755867E . . . . .42-48**  
 4-7/8" o.d. for banjo steering wheel, original 46-48. 2.820 -0



**758477F . . . . .53**  
 Clear w/ Bowtie 2.820 -0.15  
 . . . . . **\$25.00 EA** ⚠



**759457 . . . . .53-54**  
 Power steering, original 54, handmade, very nice. 2.820 -0  
 . . . . . **CALL** ⚠

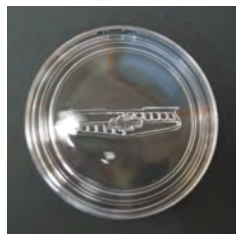

**759456D . . . . .54**  
 Clear w/ emblem. 2.820 -0.15  
 . . . . . **\$25.00 EA** ⚠

**Horn Button Metal**



**753838C . . . . .29-37**  
 Exc 37 GA (Master Deluxe w/ knee action shocks). 2.817 -0.15  
 . . . . . **\$8.75 EA** ⚠



**753327C . . . . .37-40**  
 Except GB, KA. 2.817 -0.2  
 . . . . . **\$10.00 EA** ⚠

**Horn Button Contact**



**759037 . . . . .47-57**  
 Contact w/ spring. Fits 49-57 cars (& Corvette), 37-57 Comm & Util. 2.819 -0.15

**\$6.75 EA** ⚠

**Horn Contact Plate**



**758566 . . . . .53-54**  
 Horn button snaps over, 53 150 series, 54 Sedan Delivery. 2-1/2" O.D., 9/16" I.D.

2.819 -0.15

**\$24.50 EA** ⚠

**Horn Pivot Ring**



**758104 . . . . .49-52**  
 Cars with horn ring. 2" o.d. Screws and tension ring included. 2.816 -0.15

⚠

**\$25.00 EA**



**757517 . . . . .50-54**  
 Plastic, 1-13/16in. o.d. 2.816 -0

**\$8.00 EA** ⚠

**Horn Ring Insulator**



**757520 . . . . .50-54**  
 7/16in. o.d., 50-52 accessory wheel (3 pcs). 2.819 -0.15

**\$16.50 SET** ⚠

**Horn Relay**



**1116775A . . . . .34-54**  
 6v, replacement. 2.815 -0.2

**\$20.00 EA** ⚠



**1116775B . . . . .ALL**  
 12v 2.815 -0.15

**\$15.50 EA** ⚠

**Grommet**



**1850660 . . . . .37-38**  
 Town & Country trumpet horn support. 2.845 -0.15

**\$56.75 PR** ⚠



**1874357 . . . . .39**  
 Town & Country trumpet horn support (uses 2). 2.845 -0.15

**\$45.00 EA** ⚠

**Wire Harness**



**1997713A . . . . .37-42**  
 Town & Country horn 2.832 -0  
 . . . . . **\$96.00 EA** ⚠

**Wire Pigtails**



**1860035 . . . . .40-48**  
 On horns 2.814 -0.15

**\$19.75 PR** ⚠

**1860035A . . . . .49-52**  
 On horns 2.814 -0

**\$15.00 PR** ⚠

**1860035B . . . . .53-54**  
 On horn, cloth covered. 2.814 -0.15

**\$17.25 EA** ⚠

**1860035C . . . . .53-54**  
 On horn, plastic covered 2.814 -0

**\$20.00 EA** ⚠

**Horn Wire Grommet**



**9000516 . . . . .40-54**  
 Horn wire thru horn cover (2 pcs). 2.810 -0.3

**\$5.00 SET** ⚠

**Horn Button Assembly**



**753838 . . . . .29-37**  
 S-wire, rubber button & metal cap (exc. 37 GA). 2.817 -0

**\$27.50 SET** ⚠

**753327 . . . . .37-39**  
 S-wire, rubber button & metal cap, fits GA, HA, HB, JB. 2-3/8in. x 4-3/8in. 2.817 -0

**CALL** ⚠

**753629 . . . . .39-40**  
 W/ s-wire, rubber button & metal cap-fits JA, KB, KH, 2-1/2in. x 2-7/8in. 2.817 -0.15

**\$45.00 SET** ⚠

**754058 . . . . .41-48**  
 Cars w/ horn ring. 2.816 -0.4

**\$25.00 SET** ⚠





**Horn Button S Wire**



- 753838B.....29-37**  
Exc 37 GA 3-3/4in. long  
2.817 -0.15 .....  
**\$8.75 EA** ⚠
- 753327A.....37-39**  
Fits GH, HA, HB, JB.  
3-3/4in. long. 2.817 -0  
..... **CALL** ⚠
- 753629A.....39-40**  
Fits JA, KB, KH. 2-1/4in.  
long. 2.817 -0.15 ...  
**\$15.00 EA** ⚠

**Horn Button Pad**



- 753838A.....29-37**  
Rubber (exc 37 GA).  
2.817 -0 **\$20.00 EA**  
⚠
- 752705.....37-38**  
Accessory banjo wheel.  
2.816 -0.15 .....  
**\$26.75 EA** ⚠
- 753327B.....37-40**  
Rubber (exc GB, KA).  
2.817 -0.15 .....  
**\$17.75 EA** ⚠
- 753656..... 40**  
W/ horn ring or spin  
wheel. 2.816 -0.2 ...  
**\$35.25 EA** ⚠
- 754240..... 41**  
Spinner wheel.  
2.816 -0.15 .....  
**\$35.25 EA** ⚠
- 754052.....41-46**  
Cars w/out horn ring.  
2.816 -0.15 .....  
**\$21.75 EA** ⚠
- 754062.....41-48**  
Cars w/ horn ring.  
2.816 -0.4 .....  
**\$20.00 EA** ⚠
- 754063.....41-48**  
Grommet (for screws  
under cap), cars w/  
horn ring (3 pcs).  
2.816 -0.15 ..... **\$22.50 SET** ⚠
- 756458.....41-48**  
Rubber ring under  
steering wheel, cars w/  
out horn ring. 2.819 -0.15  
..... **\$22.00 EA** ⚠
- 755904.....42-48**  
Accessory banjo wheel.  
2.816 -0.15 .....  
**\$29.25 EA** ⚠

**Bushing With Horn Wire**



- 1854761.....31-39**  
Bushings under steering  
wheel W/ horn wire  
6.521 -0 ..... **\$82.50 EA** ⚠

**Bearing With Horn Wire**



- 264887 .....39-48**  
Bearing under  
steering wheel,w/  
horn wire - exc  
beam axle (JB, KB).  
6.521 -0.4  
..... **\$25.00 EA** ⚠



- 270255 .....49-54**  
Bearing under  
steering wheel, w/  
horn wire. Except  
power steering.  
6.521 -0  
..... **\$48.00 EA** ⚠

**Odds And Ends**

- Please call for availability on all Odds & Ends parts. Once part is sold, it may no longer be in stock.
- 753741..... 40**  
Chrome spinner rim for steering wheel  
6.513 -0 ..... **\$80.00 EA** ⚠
  - 985575U ..... 40**  
Steering wheel deluxe spinner. Needs to  
be restored. (Call for price) 6.513 -0 .....  
**\$800.00 EA** ⚠
  - 755851W.....41-46**  
Steering wheel (wheel only) fits SPD & MD  
6.513 -0 ..... **\$100.00 EA** ⚠
  - 755781U .....42-46**  
Pass horn cap-Chevy emblem w/ winged  
figure. Needs paint (Used) 2.820 -0.4 ....  
**\$50.00 EA** ⚠
  - 756439U .....47-48**  
Horn Cap With Ring. Very nice (Used).  
2.820 -0 ..... **\$250.00 EA** ⚠
  - 757095U ..... 49**  
Horn ring assessor (Used) 2.830 -0 **CALL**  
⚠
  - 270255N .....49-54**  
Bearing under steering wheel (NOS) fits  
all except PG 6.521 -0 .... **\$125.00 EA** ⚠

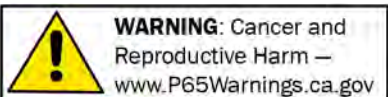

**WARNING:** Cancer and Reproductive Harm – www.P65Warnings.ca.gov

Chemicals shipped domestic ground only (Lower 48 states only). No international shipping.

**Phone: (360) 816-0211 • (800) 999-CHEV (2438) • www.chevsofthe40s.com**

**SECTION 060C  
STREET ROD PARTS**

**Main Wire Harness Street Rod  
Route 9**



**510625.....ALL**  
Route 9 Universal Wiring System from American Autowire. We often receive requests for a basic, or smaller sized, complete wiring system, and this kit is designed just for that market. -0.15  
**\$329.50 EA ⚠**

**Main Wire Harness Street Rod  
Highway 15**

HIGHWAY 15 "STREET ROD" WIRING KIT. This is a complete fuse panel and full wiring kit.  
- Developed to handle the most demanding power requirements and accessories.  
- Longer coils of wire so you can place the fuse box where YOU want it.



**13237.....ALL**  
American Autowire Highway 15-Street Rod Wire Harness 8.055 -0.15  
**\$559.75 KIT ⚠**

**Main Wire Harness Street Rod  
Highway 15-Nostalgia**

HIGHWAY 15 "NOSTALGIA" WIRING KIT. Complete fuse panel and full wiring kit. As if directly out of the 50s, this great looking system is put together with the top selling street rod wiring system. The traditional Braid & Lacquer wire, with its high gloss finish and extremely colorful flare will add that needed finishing touch while giving the best, safest and easiest to install electrical component system available today! Same great components and features as the standard Highway 15 harness such as:  
- Longer coils of wire so you can place the fusebox where YOU want it.

**Main Wire Harness Street Rod  
Highway 15-Nostalgia, cont.**



**500944.....ALL**  
American Autowire Highway 15-Nostalgia (Braided & Lacquered Wiring Kit) -0.15  
**\$1,659.00 KIT ⚠**

**Main Wire Harness Street Rod  
Highway 22**

The Highway 22 Panel packs all of the punch of a high-powered OEM system into a smaller, easy-to-install and extremely compact front loading package. The components used in this panel far exceed the power handling capabilities of any other manufacturer's system. Easy clamp-style system makes adding and removing wires easy! No Terminals! No Crimping! No Screws! Each Highway Series wiring kit comes with complete, easy to understand instructions to guide you through every step.



**500695.....ALL**  
Includes modern fuse box, instruction sheet, dash harness, instrument cluster kit, parking lamp kit, rear body kit, power plus front lighting kit, engine & starter kit, courtesy light connection kit, fuse relay flasher kit, ignition switch, headlight switch, dimmer switch and wire ties.  
2.555 -0.15  
**\$619.75 KIT ⚠**

**Clamp**



**120521.....ALL**  
1/4 in. bolt-on strap.  
For wire or tube (4 pcs).  
8.950 -0.4

**\$3.75 SET ⚠**



**120521A.....ALL**  
5/16 in, insulated bolt-on strap. For wire or tube (4 pcs).  
8.950 -0.4

**\$3.25 SET ⚠**



**120521B.....ALL**  
3/8 in. bolt-on strap.  
For wire or tube (4 pcs).  
8.950 -0.4

**\$4.25 SET ⚠**

**Basic Auto Electricity Book**

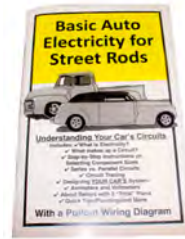

**WASBAEB . . . . ALL**  
Contains sections on: What is Electricity? Covers the battery, alternator, voltage regulator, grounding and fuses, designing a simple circuit & more including.

Circuit Diagram, Ammeter and Volt Meter usage. A full 48 pages plus Fold out Circuit Diagram and 8-1/2" x 14" Pullout Wiring Diagram to remove and customize to match your own car's circuits.  
0.000 -0.15

**\$11.75 EA ⚠**

**SECTION 060C  
RESTORATION PARTS**

Note: Turn signals are located in Section 80C.  
Note: 1937-39 kits include headlight & tail light harness plus headlight pigtail. Headlight socket is not included, original headlight socket must be used.  
Note: 1940-48 kits include headlight, tail light and park light harness plus tail light pigtails. For turn signal pigtails & sockets see Section 80C.  
Note: 1949-54 kits include headlight and park light harness plus headlight and park light pigtails but no tail light harness. For turn signal pigtails & sockets see Section 80C.  
Note: Headlight pigtail is included in main wire harness  
Note: 1953 early production cars use cloth covered harnesses. 1953 late production cars use plastic - please specify.

**Main Wire Harness**

Note: Our cloth-covered wiring harnesses below are superb reproductions with braided harness cover, and numbered ends for easy installation.



**1865875 . . . . . 37**  
This is the main wire harness that includes the headlight and tail light harnesses.

\*NOTE\*  
(does not include headlight sockets).  
2.555 -0  
**\$650.25 EA ⚠**

**Main Wire Harness, cont.**

- 5288755** ..... **38**  
Includes the headlight and tail light harnesses. (does not include headlight sockets). 2.555 -0 ..... **\$650.00 EA** ⚠
- 1873702** ..... **39**  
Includes the headlight and tail light harnesses. (does not include headlight sockets). 2.555 -0 ..... **\$645.00 EA** ⚠
- 1878860** ..... **40**  
Exc bus cpe 2.555 -0 ..... **\$743.50 EA** ⚠
- 1878860A** ..... **40**  
Bus Cpe 2.555 -0 ..... **\$729.00 EA** ⚠
- 1882438** ..... **41**  
Exc Cabriolet 2.555 -0 .. **\$783.75 EA** ⚠
- 5273682** ..... **41**  
Cabriolet 2.555 -0.15 ... **\$832.00 EA** ⚠
- 5275017** ..... **42**  
Cabriolet 2.555 -0.2 .. **\$1,142.00 EA** ⚠
- 1885092** ..... **42-48**  
Exc Cabriolet, Sedan Delivery, Wagon 2.555 -0 ..... **\$832.00 EA** ⚠
- 1885092S** ..... **42-48**  
Sedan Delivery 2.555 -0 **\$832.00 EA** ⚠
- 1885092W** ..... **42-48**  
Wagon 2.555 -0.15 ..... **\$964.00 EA** ⚠
- 1885092B** ..... **46-47**  
Cabriolet 2.555 -0 ..... **\$989.00 EA** ⚠
- 1885092C** ..... **48**  
Cabriolet 2.555 -0 ..... **\$832.00 EA** ⚠
- 5288799** ..... **49**  
Does not include tail light harness. 2.555 -0.15 ..... **\$798.00 EA** ⚠
- 5290967** ..... **50**  
Main wiring harness that has cloth covered wire like original. 2.555 -0 ..... **\$798.00 EA** ⚠
- 3695265** ..... **51-52**  
Main wiring harness that has cloth covered wire like original. 2.555 -0 ..... **\$817.00 EA** ⚠
- 5299861** ..... **53**  
W/ turn signal (cloth cover) 2.555 -0 ... **\$880.00 EA** ⚠
- 2960849** ..... **53-54**  
W/ turn signal (plastic covered) 2.555 -0 ..... **\$880.00 EA** ⚠

**Headlight Pigtail**



- 920774** ..... **37**  
Headlight and parking light pigtails for a 1937. 2.750 -0 ..... **\$81.00 SET** ⚠
- 922082** ..... **38**  
Headlight and parking light pigtails for a 1938. 2.750 -0 ..... **\$81.00 SET** ⚠
- 923367** ..... **39**  
Headlight and parking light pigtails for a 1939. 2.750 -0 ..... **\$81.00 SET** ⚠

**Headlight And Parklight Pigtails**

Note: Headlight & parklight pigtails are included in main wire harness



- 5930046B** ..... **40**  
Headlight and parking light pigtails for a '40. 2.750 -0 ..... **\$80.00 SET** ⚠
- 5932924B** ..... **41**  
Headlight and parking light pigtails for a '41. 2.750 -0.15 ..... **\$88.25 SET** ⚠
- 5932925B** ..... **42-48**  
Headlight and parking light pigtails for a '42-8. 2.750 -0 ..... **\$88.00 SET** ⚠
- 5932926B** ..... **49-52**  
Headlight and parking light pigtails for a '49-52. 2.750 -0 ..... **\$85.00 SET** ⚠
- 5932927B** ..... **53-54**  
Headlight and parking light pigtails for a '53-54. 2.750 -0 ..... **\$92.00 SET** ⚠

**Tail Light Harness**

- 4560084** ..... **49**  
2- & 4-door Sedan, exc Fleetline 2-door 13.090 -0.15 ..... **\$310.00 EA** ⚠
- 4560084W** ..... **49**  
Wagon 13.090 -0.15 .. **\$310.00 EA** ⚠
- 4560358** ..... **49**  
Coupe exc Deluxe 13.090 -0.15 ..... **\$310.00 EA** ⚠



- 4560580** ..... **49**  
Deluxe Coupe & Fleetline 2-door 13.090 -0.15 ..... **\$310.00 EA** ⚠
- 4564229** ..... **49**  
Sedan Delivery 13.090 -0.15 ..... **\$310.00 EA** ⚠
- 4579842** ..... **49-50**  
Convertible 13.090 -0 ..... **\$432.00 EA** ⚠
- 4579257** ..... **50**  
Bel Air Hardtop 13.090 -0 ..... **\$310.00 EA** ⚠
- 4579820** ..... **50**  
Wagon 13.090 -0.15 .. **\$310.00 EA** ⚠
- 4579821** ..... **50**  
Sedan Delivery 13.090 -0.15 ..... **\$310.00 EA** ⚠
- 4579825** ..... **50**  
2- & 4-door Sedan, exc. Fleetline 2-door. 13.090 -0 ..... **\$310.00 EA** ⚠
- 4579845** ..... **50**  
Coupe (all) & Fleetline 2-door 13.090 -0.15 ..... **\$377.00 EA** ⚠

**Tail Light Harness, cont.**

- 4587322** ..... **51-52**  
Deluxe 2- & 4-door Sedan exc Fleetline 2-door 13.090 -0 ..... **\$310.00 EA** ⚠
- 4587753** ..... **51-52**  
Deluxe Coupe & Fleetline 2-door 13.090 -0.15 ..... **\$319.00 EA** ⚠
- 4587793** ..... **51-52**  
Fleetline 2-door & Coupe exc Deluxe model 13.090 -0.15 ... **\$310.00 EA** ⚠
- 4588045** ..... **51-52**  
Styleline 2-door Sedan (exc Deluxe), all 4-door 13.090 -0 ..... **\$310.00 EA** ⚠
- 4588184** ..... **51-52**  
Convertible 13.090 -0 ..... **\$432.00 EA** ⚠
- 4588759** ..... **51-52**  
Hardtop 13.090 -0 ..... **\$310.00 EA** ⚠
- 4589369** ..... **51-52**  
Sedan Delivery 13.090 -0.15 ..... **\$310.00 EA** ⚠
- 4589576** ..... **51-52**  
Wagon 13.090 -0.15 .. **\$310.00 EA** ⚠
- 4605621C** ..... **53**  
150 2-door, 4-door Club Coupe, cloth covered 13.090 -0 ..... **\$312.00 EA** ⚠
- 4605657B** ..... **53**  
Bel Air 13.090 -0 ..... **\$312.00 EA** ⚠
- 4605657C** ..... **53**  
210, cloth covered 13.090 -0 ..... **\$312.00 EA** ⚠
- 4606322C** ..... **53**  
Sedan Delivery, cloth covered 13.090 -0.15 ..... **\$312.00 EA** ⚠
- 4606400C** ..... **53**  
150 Wagon, cloth covered 13.090 -0 ..... **\$312.00 EA** ⚠
- 4632532C** ..... **53**  
Convertible, cloth covered 13.090 -0 ..... **\$436.00 EA** ⚠
- 4632809C** ..... **53**  
Hardtop, cloth covered 13.090 -0 ..... **\$312.00 EA** ⚠
- 4605621** ..... **53-54**  
150 2-door, 4-door Club Coupe, plastic covered 13.090 -0.15 ..... **\$312.00 EA** ⚠
- 4605657** ..... **53-54**  
210, Bel Air, 2-door & 4-door 13.090 -0.15 ..... **\$312.00 EA** ⚠
- 4606322** ..... **53-54**  
Sedan Delivery, plastic covered 13.090 -0.15 ..... **\$312.00 EA** ⚠
- 4606571** ..... **53-54**  
Bel Air, 2- & 4-door, plastic 13.090 -0.15 ..... **\$325.00 EA** ⚠
- 4632532** ..... **53-54**  
Convertible, plastic covered 13.090 -0 ..... **\$312.00 EA** ⚠
- 4632809** ..... **53-54**  
Hardtop, plastic covered 13.090 -0.15 ..... **\$312.00 EA** ⚠

**WARNING:** Cancer and Reproductive Harm — [www.P65Warnings.ca.gov](http://www.P65Warnings.ca.gov)

Chemicals shipped domestic ground only (Lower 48 states only). No international shipping.

**Phone: (360) 816-0211 • (800) 999-CHEV (2438) • [www.chevsofthe40s.com](http://www.chevsofthe40s.com)**

060C



**Tail Light Pigtail**



**5275301A** .....**40-48**  
Tail light pigtail 13.090 -0.15 .....  
**\$25.75 PR** ⚠

**Back Up Light Harness**



**5933127A** .....**42-48**  
Includes sockets 2.697 -0 .....  
**\$76.00 EA** ⚠

**986408A** .....**51-52**  
Does not include  
light sockets. 2.697 -0  
..... **\$76.00 EA** ⚠



**986663A** .....**53-54**  
Does not include  
light sockets.  
2.697 -0.15  
..... **\$79.75 EA** ⚠

**Powerglide Harness**

Note: Powerglide harness sold separately, see listing.



**3695202** .....**50-53**  
Cloth covered 2.525 -0 .. **\$151.00 EA**  
⚠  
**5299869** ..... **53-54**  
Plastic covered 2.525 -0 . **\$156.00 EA**  
⚠

**Clock Harness**



**1882368C** ..... **39**  
Rare electric clock 9.772 -0 ..... **\$96.00 EA**  
⚠

**1882368D** ..... **40**  
Mechanical clock 9.772 -0 .. **\$33.00 EA**  
⚠

**1882368B** ..... **41**  
Rare electric clock 9.772 -0.15 .....  
**\$59.50 EA** ⚠

**1882368E** ..... **41**  
Mechanical clock 9.772 -0 .. **\$41.00 EA**  
⚠

**Heater Harness**



**3106048B**...**37-49**  
Heater & defroster  
wiring harness  
8.853 -0  
..... **\$76.00 EA** ⚠

**Horn Harness**



**1997713A**...**37-42**  
Town & Country horn  
2.832 -0  
..... **\$96.00 EA** ⚠



**1860035**...**40-48**  
On horns 2.814 -0.15  
..... **\$19.75 PR** ⚠

**1860035A** ..... **49-52**  
On horns 2.814 -0 ..... **\$15.00 PR** ⚠

**1860035B** ..... **53-54**  
On horn, cloth covered. 2.814 -0.15 .....  
**\$17.25 EA** ⚠

**1860035C** ..... **53-54**  
On horn, plastic covered 2.814 -0 .....  
**\$20.00 EA** ⚠

**Polarity Reverse Switch Wiring Harness**



**1881929**...**41-48**  
Wiring harness for  
reverse polarity  
switch. 2.122 -0.15  
..... **\$43.75 EA** ⚠

**Wire Loom**



**1846572** .....**ALL**  
Black, original hard cover to protect wiring,  
1/4 in. i.d. 2.530 -0.2 ..... **\$2.25 FT** ⚠

**1846573** ..... **ALL**  
Black, original hard cover to protect  
wiring, 3/8 in. i.d. 2.530 -0.15 .. **\$2.00 FT**  
⚠

**1846574** ..... **ALL**  
Black, original hard cover to protect  
wiring, 5/16 in. i.d. 2.530 -0.15 ..... **\$1.50 FT**  
⚠

**1846575** ..... **ALL**  
Black, original hard cover to protect  
wiring, 7/16 in. i.d. 2.530 -0.15 ..... **\$2.00 FT**  
⚠

**1846576** ..... **ALL**  
Black, original hard cover to protect  
wiring, 1/2 in. i.d. 2.530 -0.15 .. **\$2.00 FT**  
⚠

**Wire**



**985776A**.....**ALL**  
Armored steel covered. 9.773 -0.3 .....  
**\$0.75 IN** ⚠

**985777W** ..... **ALL**  
Lacquer coated braided, white. 9.773 -0.2  
..... **\$0.25 IN** ⚠

**Clip**



**148129**.....**ALL**  
(1/2 in. Slot) wiring or  
tubing (4 Pcs) 8.950 -0.15  
..... **\$7.25 SET** ⚠

**3735074A**.....**ALL**  
1/8 in. slot, wiring or  
tubing (4 pcs) 8.950 -0.15  
..... **\$7.50 SET** ⚠

**3735074C**.....**ALL**  
3/8 in. slot, gas, brake  
line, wire harness (4  
pcs). 8.950 -0.15 ....  
**\$8.25 SET** ⚠

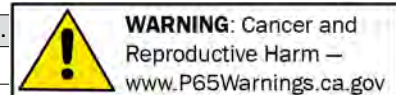

**Aluminum Bundle Straps**



**13196.....ALL**  
 .25" W X 4.05" L  
 Used to bundle wires or hoses. -0.2  
**\$4.00 EA** ⚠



**13197.....ALL**  
 .25" W X 7.15 L"  
 Used to bundle wires or hoses -0.2  
**\$5.00 EA** ⚠

**Terminal Boards**



2-3/8" center to center

**1865535 .....37-39**  
 (3 terminal) main wiring to headlight & park light pigtailed w/ rivets (some 37-39 cars were equipped w/ 3 terminal boards). Mounting holes: 2-3/8" center-to-center. 2.560 -0.15 ..... **\$24.00 PR** ⚠



3" center to center

**1998756 .....37-54**  
 (4 terminal) main wiring to headlight & park light pigtailed w/ rivets. Mounting holes: 3" center-to-center. 2.560 -0.15

**\$32.00 PR** ⚠

**1998757.....37-54**

This is a terminal board with 5 terminals for the main wiring to headlight and park light pigtailed w/ rivets. 2.560 -0

**\$38.00 SET** ⚠

**Junction Block**



**1998776.....49-54**  
 Gasket. Fuse box junction block cover  
 2.483 -0.3 .....  
**\$10.00 EA** ⚠



**986630.....53-54**  
 (accessory) use to install factory accessories (NOS) 2.483 -0.3 .....  
**\$20.00 EA** ⚠

**Junction Block Fuse Holder**



**1998776A.....49-52**  
 Fuse holder for accessory junction block (one needed for each accessory heater, radio, fan, fog lights, etc) 2.483 -0.15

**\$16.75 EA** ⚠



**3699166A.....53-54**  
 Fuse holder for accessory junction block (one needed for each accessory heater, radio, fan, fog lights, etc) 2.483 -0.15

**\$18.25 EA** ⚠

**Odds And Ends**

Please call for availability on all Odds & Ends parts. Once part is sold, it may no longer be in stock.

**1848532 .....34-37**

Spring Starter Motor 3.000 -0.4 .....  
**\$10.00 EA** ⚠

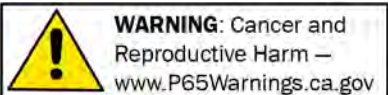

**WARNING: Cancer and Reproductive Harm** —  
[www.P65Warnings.ca.gov](http://www.P65Warnings.ca.gov)

Chemicals shipped domestic ground only (Lower 48 states only). No international shipping.

**Phone: (360) 816-0211 • (800) 999-CHEV (2438) • www.chevsofthe40s.com**

**SECTION 080C  
RESTORATION PARTS**

**Turn Signal Kit With Harness**



**9857206K .....37-52**  
W/ (2) 6v halogen bulbs, wire harness, flasher sockets & switch (specify year when ordering). 2.761-0 .....starting at **\$325.00 SET** ⚠

**9857212K .....37-52**  
W/ (2) 12v halogen bulbs, wire harness, flasher sockets & switch (specify year when ordering). 2.761-0 .....starting at **\$315.00 SET** ⚠

**Turn Signal Kit No Harness**



**9857207K .....37-52**  
W/ (2) 6v halogen bulbs, flasher sockets & switch, w/out wire harness (specify year when ordering). 2.761-0 .....starting at **\$115.00 SET** ⚠



**9857208K .....37-52**  
W/ (2) 12v Halogen Bulbs, Flasher Sockets & Switch. Wire harness not included. Specify year when ordering. 2.761-0 .....starting at **\$106.00 SET** ⚠

**Turn Signal Harness**



**985720A39 .....37-39**  
Cloth, w/ flasher socket, extra pigtail for park lights and instructions 2.761-0 ... **\$226.75 EA** ⚠

**985720A40 ..... 40**  
Cloth, w/ flasher socket, extra pigtail for park lights and instructions 2.761-0 ... **\$226.75 EA** ⚠

**985720B ..... 40-41**  
Signal harness for rare, original switch w/ original instructions 2.761-0 ..... **\$255.00 EA** ⚠

**985720A41 ..... 41**  
Cloth, w/ flasher socket, extra pigtail for park lights and instructions 2.761-0 ... **\$251.00 EA** ⚠

**Turn Signal Harness, cont.**

**985720A48 ..... 42-48**  
Cloth, w/ flasher socket, extra pigtail for park lights and instructions 2.761-0 ... **\$251.00 EA** ⚠

**985720C ..... 49-52**  
Cloth, w/ flasher socket, extra pigtail for park lights and instructions 2.761-0.15 . **\$305.25 EA** ⚠

**985720CP ..... 49-52**  
Plastic, w/ flasher socket, extra pigtail for park lights and instructions. 2.761-0 ... **\$251.00 EA** ⚠

**Turn Signal Switch**



**985720A12 ....40-41**  
Like original, 12 volt. -0 ..... **\$475.00 EA** ⚠



**985720A6 .....40-41**  
Like original, 6 volt. -0 ..... **CALL** ⚠



**5944127 ....53-54**  
Original w/ pigtails 2.895-0.15 ..... **\$25.00 EA** ⚠



**985720 .....ALL**  
Superior, with four way flasher 2.895-0.15 ..... **\$38.50 EA** ⚠



**985720E .....ALL**  
Economy 2.895-0.15 ..... **\$25.00 EA** ⚠

**Metal Cover**

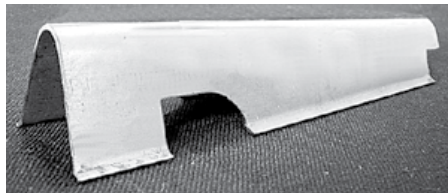

**921782 .....40-41**  
Turn signal wire (on steering column) 2.895-0.3 ..... **\$30.75 EA** ⚠

**Metal Cover, cont.**

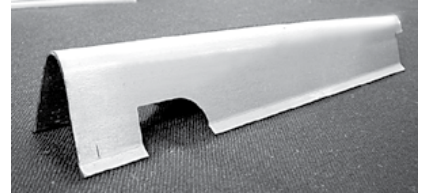

**917082 .....42-48**  
Turn signal wire (on steering column) 2.895-0.3 ..... **\$35.00 EA** ⚠



**928799A .....51-52**  
Turn signal wire (on steering column) 2.895-0 ..... **CALL** ⚠

**Turn Signal Flasher LED**



**3713382L .....ALL**  
12V. For use w/ LED lights (3 prong). Low load . 2.892-0.15 ... **\$10.75 EA** ⚠



**3713382L2 .....ALL**  
12v. For use w/ LED lights (2 prong). Low load. 2.892-0.15 .... **\$11.50 EA** ⚠



**FF552NL .....ALL**  
12v. For use w/ LED lights (2 prong). Adjustable blinker speed. 2.892-0.15 ...

**\$51.75 EA** ⚠



**FF552NLF .....ALL**  
12v. For use w/ LED (2 prong). Fixed blinker speed. 2.892-0.15 .. **\$10.75 EA** ⚠



**FF552NLP .....ALL**  
12v. For use w/ LED (2 prong). Fully adjustable PULSING blinker speed control. 2.892-0.15 .

**\$51.25 EA** ⚠

**Turn Signal Flasher Audible**



**1335230TA .....ALL**  
Audible flasher. 6v, 3 prong. 2.892-0.15 ..... **\$20.50 EA** ⚠



**Turn Signal Flasher Audible, cont.**

**3713382TA** .....ALL  
Audible flasher. 12v, 3 prong. 2.892 -0.15

**\$32.50 EA** ⚠



**FF552TA** .....ALL  
Audible flasher. 12v, 2 prong. -0.15  
**\$6.25 EA** ⚠

**Turn Signal Flasher**

**1335230**.....ALL  
6v 3 prong 2.892-0.4  
**\$7.00 EA** ⚠

**3713382**.....ALL  
12v 3 prong 2.892-0.15  
**\$7.00 EA** ⚠

**Flasher Socket**

**5297633**.....ALL  
three prong. 2.892-0.4  
**\$15.75 EA** ⚠

**Sockets And Bulbs For Park Lights With Turn Signals**



- 1873702S** .....37-39  
6v 2.750-0.15 ..... **\$12.00 SET** ⚠
- 1873702U** .....37-39  
12v 2.750-0.2 ..... **\$13.50 SET** ⚠
- 5930046S** .....40  
6v 2.750-0.15 ..... **CALL** ⚠
- 5930046U** .....40  
12v -0.15 ..... **CALL** ⚠
- 5932924S** .....41  
6v 2.750-0.15 ..... **\$14.75 SET** ⚠
- 5932924U** .....41  
12v 2.750-0.15 ..... **\$15.25 SET** ⚠
- 5932925S** .....42-48  
6v 2.050-0.2 ..... **\$17.50 SET** ⚠
- 5932925U** .....42-48  
12v 2.750-0.2 ..... **\$17.50 SET** ⚠
- 5939396S** .....49-53  
6v 2.750-0.15 ..... **\$12.00 SET** ⚠
- 5939396U** .....49-53  
12v 2.750-0.2 ..... **\$13.50 SET** ⚠
- 5939396T** .....54  
6v 2.750-0.15 ..... **\$12.00 SET** ⚠
- 5939396V** .....54  
12v 2.750-0.15 ..... **\$12.00 SET** ⚠

**Bulbs LED**

Note: LEDs are very directional and need to be angled correctly to be bright. Minimal current draw.



**145416ALED6A**...ALL  
6V Amber, offset pins.  
Replaces bulb #1154.  
8.991-0.2 **\$11.75 EA** ⚠



**145416J** .....ALL  
12V Amber, offset pins.  
Replaces bulb #1157.  
Use LED flasher  
#3713382L. 8.991-0



**145416K**.....ALL  
12v Amber, straight pins. Replaces bulb #1156. Use LED flasher #3713382L. 8.991-0.15  
**\$12.25 EA** ⚠



**145416LED6A**...ALL  
6V Amber, straight pins. single contact Replaces bulb #1156. 8.991-0.15  
**\$14.00 EA** ⚠

**145416N** .....ALL  
12v Amber, straight pins. Replaces bulb #1156. Use LED flasher #3713382L. 8.991-0.15  
**\$15.00 EA** ⚠

**Park Light Assembly**



**595825**.....37-39  
Retainer plate & wire guide for park light  
2.585-0.15  
**\$21.00 L&R** ⚠



**916957**.....37-39  
Accessory. Complete assembly, 12v  
2.585-0.15 ..... **\$126.75 EA** ⚠



**916957T**.....37-39  
Accessory. Complete with turn signal. 12v  
2.585-0.15 ..... **\$147.75 EA** ⚠

**Park Light Assembly, cont.**



**916372C** .....41  
W/ chrome rim. Fits left or right. 12v bulb. Wired for turn signals. 2.585-0.15  
**\$120.25 EA** ⚠



**928647A**.....51  
Includes bucket, socket, bulb & gasket (no lens).  
2.585-0.15  
**\$97.00 EA** ⚠



**928647AC**.....51  
Includes bucket, socket, bulb & gasket and glass  
lens. 2.585-0.15  
**\$100.00 EA** ⚠

**Rubber Boot**

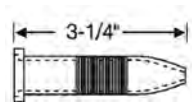

**5931846**.....41  
Rubber boot on park light for pigtail  
2.596-0.15

**\$29.75 PR** ⚠



**5933167A**.....42-48  
Rubber boot on park light for pigtail 2.596-0.2  
**\$23.75 EA** ⚠

**Park Light Lens**



**920249**.....37-39  
Accessory Glass  
2.589-0.15  
**\$23.25 EA** ⚠



**924854**.....40  
Glass 2.589-0.3  
**\$24.00 EA** ⚠



**5935778**.....41  
Glass 2.589-0.3  
**\$9.75 EA** ⚠



**5933885**.....42  
Left (NOS) 2.589-0  
**CALL** ⚠



**5936809**.....47-48  
New glass park light lens left or right.  
2.589-0.15 ..... **\$25.25 EA** ⚠



**5939934**.....51  
Glass 2.589-0.15  
**\$11.00 EA** ⚠



**5943032**.....52  
Park Light Lens.  
2.589-0.15

**\$14.00 EA** ⚠

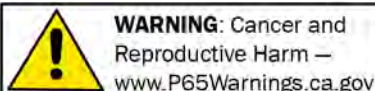

**WARNING: Cancer and Reproductive Harm** —  
www.P65Warnings.ca.gov

Chemicals shipped domestic ground only (Lower 48 states only). No international shipping.

**Phone: (360) 816-0211 • (800) 999-CHEV (2438) • www.chevsofthe40s.com**

# Section 080C: Turn Signals, Flush Mount Kits, LED Bulbs & Park Lights

## Park Light Lens, cont.

-  **5943220..... 53**  
Glass 2.589 -0.15 ...  
**\$9.00 EA** ⚠️
-  **5942343..... 54**  
Clear Plastic 2.589 -0.15  
..... **\$10.25 EA** ⚠️
-  **5942343A ..... 54**  
Amber Plastic 2.589 -0.15  
..... **\$7.00 EA** ⚠️

## Park Light Lens Gasket

-  **922758..... 40**  
Cork 2.590 -0.15 .....  
**\$3.50 PR** ⚠️
-  **5931549..... 41**  
Park Light Lens Gasket  
2.590 -0.1 ..... **\$3.75 PR**  
⚠️
-  **5936031..... 46**  
Park Light Lens Gasket  
(2 pcs). 2.590 -0.15 ..  
**\$6.00 PR** ⚠️

-  **4963808..... 47-48**  
Park Light Lens Gasket.  
2.590 -0.2 ..... **\$10.25 PR**  
⚠️

-  **5938157..... 49-50**  
Park Light Lens Gasket  
(2 pcs). 2.590 -0.2 ..  
**\$11.00 PR** ⚠️

-  **5939935..... 51**  
Park Light Lens Gasket  
(2 pcs). 2.590 -0.3 ..  
**\$9.75 PR** ⚠️

-  **5943033..... 52**  
Park Light Lens Gasket.  
2.590 -0.2 ..... **\$10.00 PR**  
⚠️

-  **5943221..... 53**  
Park Light Lens Gasket.  
2.590 -0.15 ..... **\$4.75 PR**  
⚠️

-  **5942344..... 54**  
Park Light Lens Gasket  
(2 pcs). 2.590 -0.15 ..  
**\$6.50 PR** ⚠️

## Mounting Pads



- 603313..... 37-39**  
Park light to fender (2 pcs) 2.599 -0.15  
**\$21.00 PR** ⚠️

## Mounting Pads, cont.

-  **3650817..... 40**  
Park light to fender  
2.599 -0.15 ..... **\$6.00 PR**  
⚠️
-  **3658571..... 41**  
Park light to fender  
2.599 -0.15 .....  
**\$20.50 PR** ⚠️

## Park Light Rim Screws

-  **923315..... 40**  
Stainless steel (2 pcs)  
2.688 -0.3 ..... **\$0.75 SET**  
⚠️
-  **5941434..... 41**  
Stainless steel (can be  
used for tail light)  
2.688 -0.4 ..... **\$1.75 SET**  
⚠️
-  **441784..... 47-48**  
Stainless steel (4 pcs)  
2.594 -0.4 ..... **\$4.25 SET**  
⚠️

## Park Light Rim

-  **5930230..... 40**  
Stainless 2.593 -0.15  
**\$29.75 EA** ⚠️



- 5931551..... 41**  
Chrome 2.593 -0.2 ..... **\$21.50 EA** ⚠️



- 5931551N..... 41**  
Painted (NOS) 2.585 -0 ..... **\$30.00 EA** ⚠️



- 5936033B..... 46**  
Rim for park light. Pair 2.593 -0.15 .....  
**\$340.00 L&R** ⚠️

- 5936811B..... 47-48**  
1947-48 Parking Light Rims. Beautiful  
detail in new chrome. 2.589 -0 ..... **CALL**  
⚠️

## Park Light Rim, cont.

-  **928541A..... 49**  
1949 park light body/rim. Just need to  
install your lens and backing plate.  
2.585 -0.15 ..... **\$255.00 L&R** ⚠️



- 928560A..... 50**  
1950 park light body/rim. Just need to  
install your lens and backing plate.  
2.585 -0.15 ..... **\$255.00 L&R** ⚠️

-  **5943222..... 53**  
Park Light Rim. Chrome  
2.593 -0.15 .....  
**\$10.00 EA** ⚠️

## Park Light Housing



- 3703154..... 53**  
Park Light Housing With Bezel Chrome.  
5000.000 -0 ..... **\$316.00 L&R** ⚠️

## Grill Extension For Park Lights



- 3703149B..... 53**  
Chromed grill extensions. 1.268 -0 .....  
**\$243.50 L&R** ⚠️



- 3705307B..... 54**  
Chromed park light extensions. 2.599 -0.15  
..... **\$261.75 PR** ⚠️

Returns require a return authorization number—call first. • Product pricing & availability subject to change.

72 Phone: (360) 816-0211 • (800) 999-CHEV (2438) • www.chevsofthe40s.com

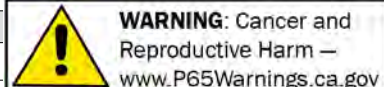



**Grill Extension For Park Lights, cont.**



**3705307C** ..... **54**  
 cast aluminum brackets for park light housings. 2.599-0.2 ..... **\$24.00 PR** ⚠



**5942334** ..... **54**  
 Park Light Rim. 2.593-0.15 .. **\$40.00 PR** ⚠

**Odds And Ends**

Please call for availability on all Odds & Ends parts. Once part is sold, it may no longer be in stock.

**5935778U** ..... **41-46**

Lens-park Light Used (orig 41) 2.590-0.4 .. **\$20.00 EA** ⚠

**929841N** ..... **42**

Rim-park Light (nos) Left Painted 2.593-0.4 ..... **\$35.00 EA** ⚠

**929841U** ..... **42**

Rim-park Light Used Left Painted 2.593-0.4 ..... **\$20.00 EA** ⚠

**5931551U** ..... **42-46**

Rim. 41 Parklight, 42-48 Backup light (Used). 02.697 / 2.593-0.4 ... **\$7.00 EA** ⚠

**3701634** ..... **53**

Pad, lamp bracket 11.950-0.4 **\$20.00 EA** ⚠

**5943220AP** ..... **53**

Lens-park Light (NOS) (plastic) 2.589-0.4 **\$12.00 EA** ⚠

**594322U** ..... **53**

Rim-park Light (used Very Nice) 2.593-0.4 ..... **\$25.00 EA** ⚠

**SECTION 085C RESTORATION PARTS**

Note: Headlight and spotlight bulbs see Section 100C.

**985573PL** ..... **40-42**

Passing Lamp Lens - Guide Super Ray 7-7/8" -0 ..... **\$90.00 EA** ⚠

**Driving Lights**

Note: GM SCRIPT Driving Lights include brackets. Fog lights are amber, driving lights are clear.

**985573DL** ..... **36-39**

Driving Lamp Lens - Guide Super Ray 7-7/8" -0 ..... **\$90.00 EA** ⚠



**409185** ..... **ALL**

Clear, 6v, 5 in. (specify year when ordering). 9.774-0 starting at **\$244.00 PR** ⚠

**409185A** ..... **ALL**

Clear, 12v, 5 in. (specify year when ordering). 9.774-0.4 ..... starting at **\$241.00 PR** ⚠

**409186** ..... **ALL**

Clear, 6v, 6 in. (specify year when ordering). 9.774-0 starting at **\$244.00 PR** ⚠

**409186A** ..... **ALL**

Clear 12v, 6 in. (specify year when ordering). 9.774-0 starting at **\$244.00 PR** ⚠

**Fog Light**



**985174** ..... **37-38**

Amber nice repro w/ brackets. 9.774-0 **\$309.50 PR** ⚠

**985174C** ..... **37-38**

Amber nice repro w/ chrome brackets. 9.774-0 ..... **\$309.50 PR** ⚠



**985444** ..... **39**

Amber nice repro w/ brackets. 9.774-0 **\$309.00 PR** ⚠

**Fog Light, cont.**

**985444C** ..... **39**

Amber nice repro w/ chrome brackets. 9.774-0 ..... **\$316.25 PR** ⚠

**985448** ..... **40**

Amber nice repro w/ brackets. -0 ..... **\$310.00 PR** ⚠

**985448C40** ..... **40**

Amber nice repro w/ chrome brackets. -0 ..... **\$310.00 PR** ⚠



**409182** ..... **ALL**

Amber with GM script. 6v, 5 in. dia. (specify year when ordering). 9.774-0 starting at **\$244.00 PR** ⚠

**409182A** ..... **ALL**

Amber with GM script. 12v, 5 in. dia. (specify year when ordering). 9.774-0 starting at **\$244.00 PR** ⚠

**409183** ..... **ALL**

Amber with GM script. 6v, 6in. dia. (specify year when ordering). 9.774-0 starting at **\$244.00 PR** ⚠

**409183A** ..... **ALL**

Amber with GM script. 12v, 6in. dia. (specify year when ordering). 9.774-0 starting at **\$244.00 PR** ⚠

**Fog Light Lens**



**921415** ..... **37-38**

Amber. 6-5/16" o.d. 9.774-0.15 ..... **\$29.00 EA** ⚠



**923706** ..... **39**

Amber (original repro). 6-3/4" dia. 9.774-0 ..... **CALL** ⚠

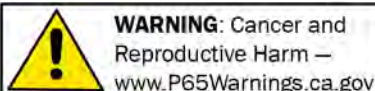

**WARNING: Cancer and Reproductive Harm** — www.P65Warnings.ca.gov

Chemicals shipped domestic ground only (Lower 48 states only). No international shipping.

**Phone: (360) 816-0211 • (800) 999-CHEV (2438) • www.chevsofthe40s.com**

085C



**Fog Light Lens, cont.**



**923706R** ..... **39**  
Amber. Fits reproduction fog lights. 6-1/4"  
o.d. 9.774 -0.15 ..... **\$35.25 EA** ⚠

**Fog Light Rim**



**5930366** ..... **40**  
Chrome (NOS). 7" o.d. 9.774 -0 ..... **CALL**  
⚠

**Fog Light Emblem**



**984716E** ..... **41**  
Painted details  
9.774 -0 ..... **CALL** ⚠

**Fog Light Bracket**



**986120A** ..... **42-54**  
Grommet (rubber), in  
apron. 9.774 -0.15 .....  
**\$22.00 PR** ⚠

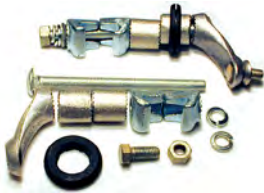

**5933244** ..... **ALL**  
W/ apron on bumper brackets. 9.774 -0  
..... **\$75.00 SET** ⚠

**Switch**



**924160** ..... **ALL**  
Fog light, backup  
light, etc, rotary.  
Clamps to dash  
bottom. 9.774 -0.2  
..... **\$23.00 EA** ⚠

**Spotlights**

Note: GM SCRIPT Spotlights which include  
right or left bracket and template.



**985993B** ..... **37-54**  
6v, 5 in. Specify year (39 not available) &  
left or right when ordering. 9.773 -0 .....  
starting at **\$284.00 EA** ⚠

**985993C** ..... **37-54**  
6v, 6 in. (original in 42-48). Specify year  
(39 not available) & left or right when  
ordering. 9.773 -0 ..... starting at **\$284.00 EA**  
⚠

**985993D** ..... **37-54**  
12v, 5 in. Specify year (39 not available)  
& left or right when ordering. 9.773 -0 .....  
starting at **\$273.00 EA** ⚠

**985993E** ..... **37-54**  
12v, 6 in. Specify year (39 not available)  
& left or right when ordering. 9.773 -0.4 .....  
starting at **\$273.00 EA** ⚠

**Spotlight Brackets**



**1937-38 Shown**

**985993L** ..... **37-54**  
Left (specify year when ordering).  
9.773 -0.15 ..... starting at **\$54.00 EA** ⚠



**985993R** ..... **37-54**  
Right (specify year when ordering). 9.773 -0  
..... starting at **\$54.00 EA** ⚠

**Spotlight Handle**



**985998B** ..... **ALL**  
Ivory w/ chrome housing & switch for  
spotlight. 9.773 -0.15 ..... **\$60.00 EA** ⚠

**Spotlight Ornament**



**985993N** ..... **37-54**  
W/ GM tag. Mounts  
on top of spotlight,  
fog light or driving  
light. 9.773 -0.15  
..... **\$17.50 EA** ⚠

**GM Script Tag**



**985993M** ... **37-54**  
Top of driving lights,  
fog lights and  
spotlight. 9.773 -0.15  
..... **\$9.59 EA** ⚠

**Fuse Holder**



**985775A** ..... **ALL**  
Metal fuse holder.  
9.773 -0.15 .....  
**\$12.00 EA** ⚠

**Wire Assembly**



**985774A** ..... **ALL**  
W/ armored steel  
covered, cloth wire &  
metal fuse holder for  
spotlight, as original.  
9.773 -0.2 ..... **\$31.00 SET** ⚠

**Wire**



**985776A** ..... **ALL**  
Armored steel covered. 9.773 -0.3 .....  
**\$0.75 IN** ⚠  
**985777W** ..... **ALL**  
Lacquer coated braided, white. 9.773 -0.2  
..... **\$0.25 IN** ⚠

**SECTION 090C  
STREET ROD PARTS**

**Headlight 7" Conversion Kit**



**920544S . . . . .37-38**

This kit consist of a foam/rubber seal that allows you to use 7" lights. Does not include the bucket, headlight or trim. NOTE:

Will not work with #31378 or #31379 or #S2010LED Headlights. Cars only 2.727 -0.3

**\$18.75 PR** ⚠️

**Sealed Beam Conversion Kit**



**923344S . . . . . 39**

Convert your stock housing to 7 inch sealed beam. Includes inner & outer bucket, sealed beam, pigtail & retaining ring. Modification

to original housing required. Includes mounting instructions. Cars only 2.727 -0

**\$159.00 EA** ⚠️

**Headlight Halogen with LED Turn Signal**

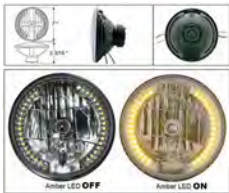

**31378 . . . . .ALL**

7 inch, 12 Volt H-4 Halogens with amber LED turn signal or marker lights One row of LED lights on each side. Glass lens.

2.726 -0.15 **\$70.25 EA** ⚠️



**31379 . . . . .ALL**

7 inch, 12 Volt H-4 Halogens with white LED turn signal or marker lights. One row of LED lights on each side. Glass lens.

2.726 -0.15 **\$72.50 EA** ⚠️

**Headlight Halogen with LED Turn Signal, cont.**



**S2010LED . . . . .ALL**

7 inch, 12 Volt H-4 Halogens with amber LED turn signal-marker lights. One row of LEDs at the bottom of light. Glass lens.

-0.15 **\$54.00 EA** ⚠️

**Headlight Halogen with LED Halo**



**31380HALO . . . . .ALL**

7 Inch, 12 Volt Headlight H-4 Halogens With Multi Color LED Halo, Includes Remote (No Turn Signal).

NOTE: Will not work on 37-38 Sealed Beam Conversion Kit (#920544S) -0.15

**\$285.25 PR** ⚠️



**31381HALO . . . . .ALL**

7 Inch, 12 Volt Headlight H-4 Halogens With White LED Halo (No Turn Signal)

NOTE: Will not work on 37-38 Sealed Beam Conversion Kit (#920544S) -0.15

**\$230.25 PR** ⚠️

**31382HALO . . . . .ALL**

7 Inch, 12 Volt Headlight H-4 Halogens With Multi-Color LED Halo, includes remote. Black Illusion (No Turn Signal)

-0.15 **\$335.25 PR** ⚠️



**31383HALO . . . . .ALL**

7 Inch, 12 Volt Headlight H-4 Halogens With Multi Color LED Halo and Amber Turn signals, Includes Remote.

NOTE: Will not work on 37-38 Sealed Beam Conversion Kit (#920544S) -0.15

**\$335.25 PR** ⚠️

**Headlight Halogen with LED Halo, cont.**



**31384HALO . . . . .ALL**

7 Inch, 12 Volt Headlight H-4 Halogens With White LED Halo and Amber Turn Signals.

NOTE: Will not work on 37-38 Sealed Beam Conversion Kit (#920544S) -0.15

**\$280.25 PR** ⚠️

**LED Headlight Kit**



**5947212L . . . . .ALL**

Includes 2 - 7 inch headlights and LED bulbs. -0

**\$150.00 SET** ⚠️

**LED Headlight Conversion**



**MAI011 . . . . .ALL**

Hi/Low beam LED headlight conversion kit. Replaces H4 bulbs.

Voltage: DC 10V-32V. -0.15 **\$65.00 PR**

⚠️

**HID Headlight Conversion Plug And Play**



**HIDCONV01 . . . . .ALL**

Low beam Xenon HID w/ H4 Halogen high beam. 6000K.(off-road use only).

2.727 -0.15 **\$100.00 PR** ⚠️

**HIDCONV02 . . . . .ALL**

Low & High beam Xenon. Converts halogens. H4 6000K. (off-road use only).

2.727 -0.15 **\$88.75 PR** ⚠️

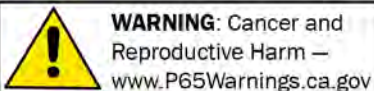



# Section 090C: HID Headlight Conversions, Halogen Conversions, Headlight Components, Rims, Seals & Switches

## Halogen Headlight Conversion

The following kits require modification



**110185A** ..... **31-39**  
Halogen bulb. 12V headlight conversion. Double the light of sealed beam, retains original appearance. Uses original lens & reflector. Clear. Some trimming/modifications may be necessary. 8.991 -0

**CALL** ⚠️

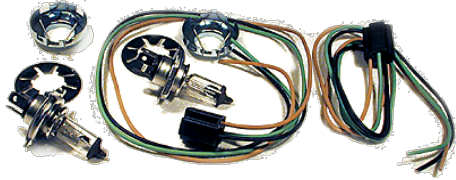

**110185D** ..... **31-39**  
Halogen bulb. 6V headlight conversion. Double the light of sealed beam, retains original appearance. Uses original lens & reflector. Clear. Some trimming/modifications may be necessary. 8.991 -0.15

**\$49.50 PR** ⚠️



**920773K** ..... **37-39**  
Reflector w/ clear halogen headlight bulb & dual element amber

park light bulbs (12v). Trim to fit. Cars only 2.734 -0

**CALL** ⚠️



**920773KB** ..... **37-39**  
Reflector w/ blue halogen headlight bulb & amber park light bulbs (12v). Trim to fit.

2.734 -0

**CALL** ⚠️



**920773L** ..... **37-39**  
Reflector w/ clear halogen headlight bulb & clear park light bulbs (6v). Trim to fit. Cars

only 2.734 -0

**CALL** ⚠️

## Headlight Reflector



**920773H** ..... **37**  
With 12V halogen bulb. 2.734 -0.15

**\$296.00 PR** ⚠️



**920773J** ..... **37**  
12V with marker light. Includes bulbs. 2.734 -0.15

**\$191.25 PR** ⚠️

## Headlight Bucket



**923441F** ..... **39**  
Fiberglass. 2.726 -0.15  
..... **\$284.00 EA** ⚠️

## Tri Bar Headlight Cover



**193142TB** ..... **ALL**  
Blue Dot. Fits 7 inch headlights. 2.731 -0.15  
..... **\$12.50 EA** ⚠️



**193142TC** ..... **ALL**  
Chrome Bullet. Fits 7 inch headlights. 2.731 -0.15

**\$12.50 EA** ⚠️

## Headlight Visor



2.731 -0.2

**193142A** ..... **ALL**  
Chrome half moon. Fits 7 inch round headlights.

**\$10.75 PR** ⚠️



**193142AM** ..... **ALL**  
Amber acrylic with chrome trim plate. Fits 7 inch round headlights. 2.731 -0.15

**\$14.25 PR** ⚠️



**193142B** ..... **ALL**  
Chrome plated w/ blue dot jewel. Fits 7 inch round headlights. 2.731 -0.15

**\$26.25 PR** ⚠️



**193142D** ..... **ALL**  
Chrome plated. Fits 7 inch round headlights. 2.731 -0.15

**\$21.75 PR** ⚠️



**193142GR** ..... **ALL**  
Green acrylic with chrome trim plate. Fits 7" round. 2.731 -0.15

**\$14.25 PR** ⚠️



**193142RE** ..... **ALL**  
Red acrylic with chrome trim plate. Fits 7" round. 2.731 -0

**CALL** ⚠️

## SECTION 090C RESTORATION PARTS

### Headlight Bucket



**924535** ..... **40-54**  
Inner only. Black steel. 2.726 -0.15  
..... **\$36.00 EA** ⚠️



**924535M** ..... **40-54**  
Modified for H.I.D. headlight conversion kits. Inner only. Steel. 2.726 -0.2  
..... **\$69.25 EA** ⚠️

### Headlight Bucket Assembly



**5932796C** ..... **42-52**  
Zinc plated. Complete w/ original style pigtail (plastic wires in plastic loom), retainer & 12v bulb (no rim). 2.726 -0.15  
..... **\$75.00 EA** ⚠️



**5932796D** ..... **42-52**  
Black. Complete w/ original style pigtail (plastic wires in cloth loom), retainer & 12v bulb (no rim). 2.726 -0  
..... **\$95.00 EA** ⚠️

### Headlight Lens

Note: Headlight bulbs see Section 100C.



**920544** ..... **37-38**  
Headlight lens. 2.727 -0.2  
..... **\$70.00 EA** ⚠️





# Section 090C: HID Headlight Conversions, Halogen Conversions, Headlight Components, Rims, Seals & Switches

## Headlight Lens, cont.



**923344**..... 39  
Glass replacement lens. 2.727 -0.15  
\$40.00 EA ⚠

## Mounting Pads

**598010A**..... 37  
Headlight stand.  
2.544 -0.4 \$8.00 L&R ⚠

**350778A**..... 38  
Headlight stand  
2.544 -0.15  
\$38.75 L&R ⚠

**923441A**..... 39  
Headlight assembly,  
made from rubber.  
2.544 -0.15  
\$27.25 L&R ⚠

**5930996**..... 40  
Headlight assembly  
2.544 -0.15  
\$30.00 L&R ⚠

## Headlight Bucket Gasket

**3722121**..... 41-54  
Head lamp bucket to  
fender. 8-1/2 in. x 1/8  
in. thick. 2.722 -0.15  
\$7.00 PR ⚠

## Clutch Head Driver



**DRIVER**.....ALL  
Magnetic clutch head driver, Chevs  
imprint. w/ 5 bits (1/8 in., 5/32 in., 3/16  
in., 1/4 in., 5/16 in.) 8.821 -0.15  
\$22.25 SET ⚠

## Clutch Head Screws



**5932796A**..... 41-54  
W/ tin u-nuts, attach headlight bucket to  
fender (32 pcs) 2.726 -0.15 \$10.50 SET  
⚠

## Headlight Components

**924561**..... 40-58  
Headlight adjustment  
screw (2 pcs) 2.737 -0.4  
\$1.75 PR ⚠



**924561B**..... 40-58  
Headlight Adjusting Screw & Nut (Requires  
2 Per Headlamp) 2.737 -0.3 \$6.75 SET  
⚠

**5939769**..... 41-57  
Headlight adjustment  
screw nut. Nylon.  
2.737 -0.15 \$1.50 EA  
⚠

## Tool Clutch Head Socket Set



**CHSS-4**.....ALL  
4 pc. 3/8 Drive. Includes 5/16", 1/4",  
3/16", 5/32" sockets. 8.821 -0.15  
\$21.00 SET ⚠

## Headlight Bucket Spring

**924551**..... 40  
Tension adjusting  
2.721 -0.15 \$5.50 EA  
⚠

**5937452**..... 41-54  
Tension adjusting  
2.721 -0.15 \$3.50 EA  
⚠

## Headlight Trim Ring

**923345**..... 37-39  
Fits in front of headlight  
rim as garnish trim  
(stainless) 2.731 -0.15  
\$25.00 EA ⚠

## Sealed Beam Retainer Ring

**924534**..... 40-54  
Sealed Beam Retainer  
Ring 2.731 -0.15  
\$11.00 EA ⚠

**924534S**..... 40-54  
Stainless 2.731 -0  
CALL ⚠

**924622**..... 40-54  
Retainer screws (3 pcs)  
2.729 -0.3 \$3.50 SET  
⚠

## Headlight Rim

**921514**..... 36-39  
Chrome (36 car, 37-39  
trucks exc COE). Does  
not come with tab or  
screw 2.728 -0.15

**920798C**..... 37-38  
Chrome 2.728 -0  
CALL ⚠

**924687**..... 39  
Chrome. Does not have  
tab at top. 2.728 -0.15  
\$40.00 EA ⚠

**924722**..... 40  
Chrome 2.728 -0.15  
\$28.50 EA ⚠

**924565**..... 41  
Chrome 2.728 -0  
CALL ⚠

**5932799**..... 42-48  
Painted 2.728 -0  
CALL ⚠

**5932799C**..... 42-48  
Chrome 2.728 -0  
CALL ⚠

**5941285**..... 49-52  
Door w/ clips. Stainless  
steel (no tab). 2.728 -0.15  
\$18.75 EA ⚠

**5944987**..... 54  
Stainless w/ clips and  
black painted details.  
2.748 -0.15  
\$84.00 EA ⚠

## Headlight Lens Seal

**605918**..... 32-39  
2 pieces.cork rubber  
2.735 -0.3 \$11.25 PR  
⚠

**605920**..... 38  
2 pcs 2.735 -0.2  
\$10.00 PR ⚠

**5930594A**..... 40-54  
Headlight rim to sealed  
beam retainer 2.735 -0.3  
\$14.50 PR ⚠

**5930594C**..... 40-54  
W/ wire insert headlight  
rim to retainer  
2.735 -0.15  
\$16.00 PR ⚠

## Headlight Rim Seal Clip

**5934791**..... 40-52  
Exc 42-48, does 2.  
2.746 -0.15  
\$8.00 SET ⚠

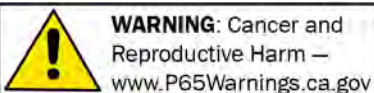

**WARNING:** Cancer and  
Reproductive Harm —  
www.P65Warnings.ca.gov

Chemicals shipped domestic ground only (Lower 48 states only). No international shipping.

Phone: (360) 816-0211 • (800) 999-CHEV (2438) • www.chevsofthe40s.com

090C

# Section 090C: HID Headlight Conversions, Halogen Conversions, Headlight Components, Rims, Seals & Switches

## Headlight Rim Seal Clip, cont.



**914127** ..... **42-48**  
6 pcs 2.746 -0.3 .....  
**\$4.75 SET** ⚠️

## Headlight Wire Grommet



**922285** ..... **37-38**  
Tail light or headlight  
wire thru body. 9.775 -0.2  
..... **\$13.25 EA** ⚠️



**350278** ..... **39-40**  
Wire (fender top)  
9.775 -0 .. **\$8.00 PR**  
⚠️



**3673139** ..... **39-54**  
Inner panel for  
headlight, park light  
pigtailes (41 uses 2 pr,  
others use 1 pr)

9.775 -0.4 .....

**\$3.50 PR** ⚠️



**5931584** ..... **41-56**  
Bucket for pigtail (2  
pcs) 9.775 -0.15 .....  
**\$4.00 PR** ⚠️

## Terminal Boards



2-3/8" center to center

**1865535** ..... **37-39**

(3 terminal) main wiring to headlight &  
park light pigtailes w/ rivets (some 37-39  
cars were equipped w/ 3 terminal boards).  
Mounting holes: 2-3/8" center-to-center.  
2.560 -0.15 ..... **\$24.00 PR** ⚠️



3" center to center

**1998756** ..... **37-54**

(4 terminal) main wiring to headlight &  
park light pigtailes w/ rivets. Mounting  
holes: 3" center-to-center. 2.560 -0.15

**\$32.00 PR** ⚠️

## Headlight Switch



**1995040** ..... **30-39**

Replacement 2.485 -0 ... **\$25.00 EA** ⚠️

## Headlight Switch, cont.



**1995040A** ..... **30-39**

Delco original replacement, w/ removable  
shaft. Black knob, white "LIGHTS" text.  
2.485 -0 ..... **CALL** ⚠️



**1995041A** ..... **40-54**

Replacement, nonremovable shaft. 12  
volt. 2.485 -0.15 ..... **\$19.75 EA** ⚠️



**1995041R** ..... **40-54**

For use w/ original nut, knob & removable  
shaft (locking groove on end only).  
Includes spade terminals. 12v 2.485 -0.15  
..... **\$42.00 EA** ⚠️



**1995041SC** ..... **40-54**

6 Volt. For use w/ original nut, knob &  
removable shaft (locking groove on end  
only). Screw terminals. 2.485 -0.15 .....  
**\$55.75 EA** ⚠️



**1995041TC** ..... **40-54**

12Volt. For use w/ original nut, knob &  
removable shaft (locking groove on end  
only). Screw terminals. 2.485 -0.15 .....  
**\$55.75 EA** ⚠️

## Headlight Switch Retaining Nut



**1995041C** ..... **40-54**  
Stainless 2.485 -0.15  
**\$12.50 EA** ⚠️

## Headlight Knob



**1861895** ..... **36**  
Standard, black.  
2.486 -0.15 .....

**\$14.00 EA** ⚠️



**593860A** ..... **37**  
Black. Original color  
and quality. 2.486 -0.15  
..... **\$14.00 EA** ⚠️



**597533A** ..... **38**  
Ivory. Original color and  
quality. 2.486 -0.4 ...

**\$14.00 EA** ⚠️



**599352** ..... **39**  
Rose tan 2.486 -0.15  
**\$12.00 EA** ⚠️



**3653818B** ..... **40**  
Ivory 2.486 -0 .. **CALL**  
⚠️



**3654033A** ..... **40**  
Brown. Original color  
and quality. 2.486 -0.4  
..... **\$14.00 EA** ⚠️



**3658534A** ..... **41**  
Chrome w/ copper swirl  
center. 2.486 -0.15 ...

**\$14.00 EA** ⚠️



**3664777A** ..... **42-48**  
Ivory w/ copper swirl  
center. Original color  
and quality. 2.486 -0.4  
..... **\$10.00 EA** ⚠️



**1990696A** ..... **51-52**  
Ivory w/ chrome insert.  
Original color and  
quality. 2.486 -0 .....

**CALL** ⚠️

## Headlight Switch Shaft



**3653818S** ..... **40-54**

Removable type 2.485 -0.4 **\$5.00 EA** ⚠️



**1990662** ..... **49**

W/ shaft 2.486 -0.15  
**\$16.00 EA** ⚠️

Returns require a return authorization number—call first. • Product pricing & availability subject to change.



**WARNING:** Cancer and  
Reproductive Harm —  
www.P65Warnings.ca.gov



**Headlight Switch Shaft, cont.**



- 1990662A** ..... **49**  
Ivory Knob. Original color and quality.  
2.486 -0.4      **\$14.00 EA** ⚠
- 1990689**..... **50**  
W/ shaft 2.486 -0.15  
**\$16.00 EA** ⚠
- 1990689A** ..... **50**  
Knob. Original color and quality. 2.486 -0.4 ...  
**\$14.00 EA** ⚠
- 1990696**..... **51-52**  
W/ shaft, ivory w/ chrome insert.  
2.486 -0.15 .....  
**\$20.00 EA** ⚠

**Dimmer Switch**



- 1997008** ..... **29-54**  
Dimmer Switch. Includes fasteners.  
2.459 -0.2 ..... **\$23.50 EA** ⚠

**Headlight Relay**



- 1116789A** ..... **37-54**  
6v replacement style.  
2.485 -0.15 .....  
**\$34.25 EA** ⚠
- 1116789B** ..... **ALL**  
12v 2.485 -0.3 ..... **\$56.00 EA** ⚠

**Odds And Ends**

Please call for availability on all Odds & Ends parts. Once part is sold, it may no longer be in stock.

- 03870**.....**37-46**  
Headlight Switch, 37-38 Pass & 40-46 Truck 9.000 -0.4 ..... **\$55.00 EA** ⚠
- 3658534** ..... **41**  
Headlight Knob & Shaft, chrome with copper swirl center 2.485 -0 ..... **CALL** ⚠
- 3665094** ..... **42-48**  
Knob W/shaft, Chrome Copper Center Used 2.485 -0.4 ..... **\$35.00 EA** ⚠
- 1995041U** ..... **47-54**  
Headlight Switch 2.487 -0.4      **\$95.00 EA** ⚠
- 5941285U** ..... **49-52**  
Rim headlight door. Chrome, shelf worn (Used) 2.728 -0.4 ..... **\$10.00 EA** ⚠

**SECTION 100C STREET ROD PARTS**

**Headlight Bulb Halogen**



- 5947212H**..... **ALL**  
7 inch, 12V. Flat glass lens & replaceable halogen bulb. 2.727 -0.15 ..... **\$19.50 EA** ⚠

**Headlight**



- HAGLBDT** ..... **ALL**  
Blue Dot, halogen sealed 7 inch lamp. Comes with H-4 bulbs. 2.727 -0.15 .. **\$88.50 EA** ⚠



- HAGLSE**..... **ALL**  
Snake Eye, halogen sealed 7 inch lamp. Comes with H-4 bulb. 2.726 -0.15 ... **\$77.00 EA** ⚠

**Halogen Headlight Bulb Conversion**



- 110185B**..... **ALL**  
Headlight bulb. Clear 6v, H4 replacement.  
8.991 -0.15 .....  
**\$23.50 EA** ⚠



- 110185C**..... **ALL**  
Headlight bulb. Clear 12v, H4 replacement.  
8.991 -0.15 .....  
**\$15.00 EA** ⚠

**Bulbs LED**



- 145416ALED6R** . . . **ALL**  
6 Volt Red, offset pin. Replaces bulb #1154.  
8.991 -0.2 .. **\$9.75 EA** ⚠



- 145416ALED6W** . **ALL**  
6 Volt White, offset pin. Replaces bulb #1154.  
8.991 -0.2 .. **\$9.00 EA** ⚠



- 145416L**..... **ALL**  
12 Volt Red, offset pin. Replaces bulb #1157. Use LED flasher #3713382L. 8.991 -0.3 ..... **\$24.50 EA** ⚠

**WARNING:** Cancer and Reproductive Harm — [www.P65Warnings.ca.gov](http://www.P65Warnings.ca.gov)

100C



# Section 100C: Light Bulbs & Sealed Beams, LED Signals

## Bulbs LED, cont.



**145416LED6R . . . . .ALL**  
6 Volt Red, straight pin.  
Replaces bulb #1156.  
8.991 -0.15 . . . . . **\$9.75 EA** ⚠



**145416LED6W . . . . .ALL**  
6 Volt White, straight  
pin. Replaces bulb  
#1156. 8.991 -0.2 . . . . .  
**\$10.50 EA** ⚠

**145416LW . . . . .ALL**  
12 Volt Red, offset pin. Replaces bulb  
#1157. Use LED flasher #3713382L.  
8.991 -0 . . . . . **CALL** ⚠



**145416M . . . . .ALL**  
12 Volt Red, straight pin  
(single contact).  
Replaces bulb #1156.  
Use LED flasher

#3713382L. 8.991 -0.3 . . . . . **\$23.25 EA** ⚠  
**145416N . . . . .ALL**  
12v Amber, straight pins. Replaces bulb  
#1156. Use LED flasher #3713382L.  
8.991 -0.15 . . . . . **\$15.00 EA** ⚠

## Bulbs Halogen



**145416B . . . . .37-54**  
Halogen tail light & park  
light w/ turn signal, 12v,  
dual filament, 30/10  
watt, offset pin, replacement for #1157.

8.991 -0.15 . . . . . **\$8.50 EA** ⚠



**145416C . . . . .37-54**  
Halogen tail light & park  
light, 6v 50 watt, single  
filament, straight pin. 8.991 -0.15 . . . . .

**\$28.00 EA** ⚠



**145416D . . . . .37-54**  
Halogen tail light & park  
light, 6v 20 watt, single  
filament, straight pin.  
8.991 -0.15 . . . . .

**\$17.00 EA** ⚠



**145416F . . . . .37-54**  
Halogen tail light & park  
light w/ turn signal, 6v  
23/5 watt, dual

filament, straight pin, replacement for  
#1158. 8.991 -0.15 . . . . . **\$27.25 EA** ⚠



**145416E . . . . .ALL**  
Halogen tail light & park  
light w/ turn signal, 6v  
65/10 watt, dual

filament, offset pin, replacement for  
#1154. 8.991 -0 . . . . . **CALL** ⚠



**145416G . . . . .ALL**  
Halogen tail light & park  
light w/ turn signal, 12v,  
dual filament, 55/5

watt, straight pins, replacement for  
#1156. 8.991 -0.15 . . . . . **\$20.00 EA** ⚠

## Bulbs Halogen



**145416H . . . . .ALL**  
Halogen tail light & park  
light, 12v 20 watt,  
single filament, straight  
pin. 8.991 -0.3 . . . . .

**\$12.00 EA** ⚠



**145416I . . . . .ALL**  
Halogen tail light & park  
light, 12v 20 watt,  
single filament, straight

pin. 8.991 -0 . . . . . **CALL** ⚠

## SECTION 100C RESTORATION PARTS

### Headlight Bulb Halogen



**110185H . . . . .ALL**  
7 inch 6V. Flat  
lens & replaceable  
halogen bulb.  
2.727 -0.15 . . . . .

**\$41.50 EA** ⚠

### Headlight Bulbs



**193142 . . . . .40-54**  
Sealed beam 6v. 2.727 -0 . . . . . **CALL** ⚠



**193142H . . . . .40-54**  
Halogen Sealed beam 6v. 2.727 -0.2 . . . . .

**\$33.75 EA** ⚠

**5947212 . . . . .ALL**  
Sealed beam 12v. 2.727 -0.2 . . . . .

**\$20.00 EA** ⚠

### Spotlight Bulbs



**444279 . . . . .ALL**  
6 in. sealed beam, 6v, #4535. For Unity  
spot lights. 9.773 -0.15 . . . . . **\$34.00 EA** ⚠

**451927 . . . . .ALL**  
5 in. sealed beam, 12v, #4405 (fits unity  
spotlight only). For Unity spot lights.  
9.773 -0.2 . . . . . **\$51.50 EA** ⚠

## Spotlight Bulbs, cont.



**456720 . . . . .ALL**  
6 in. sealed beam, 12v, #4435. For Unity  
spot lights. 9.773 -0.15 . . . . . **\$24.00 EA** ⚠

**987264 . . . . .ALL**  
5 in. sealed beam, 6v, #4515. For Unity  
spot lights. 9.773 -0.3 . . . . . **\$34.00 EA** ⚠

## Driving Light Bulbs



**3936674 . . . . .ALL**  
5 in. sealed beam. Clear, 6v, #4015. For  
Unity driving lights. 9.774 -0.2 . . . . .

**\$39.00 EA** ⚠

**593837 . . . . .ALL**  
5 in. sealed beam. Clear, 12v, #4415. For  
Unity driving lights. 9.774 -0.3 . . . . .

**\$29.00 EA** ⚠



**986942 . . . . .ALL**  
6 in. sealed beam. Clear, 6v, #4012. For  
Unity driving lights. 9.774 -0.2 . . . . .

**\$39.00 EA** ⚠

**987263 . . . . .ALL**  
6 in. sealed beam. Clear, 12v, #4412. For  
Unity driving lights. 9.774 -0.15 . . . . .

**\$48.50 EA** ⚠

## Fog Light Bulbs



**3936674A . . . . .ALL**  
5 in. sealed beam, amber, 6v, #4015A. For  
Unity fog lights. 9.774 -0 . . . . . **CALL** ⚠

**593837A . . . . .ALL**

5 in. sealed beam, amber, 12v, #4415A.  
For Unity fog lights. 9.774 -0.2 . . . . .

**\$25.75 EA** ⚠

Returns require a return authorization number—call first. • Product pricing & availability subject to change.

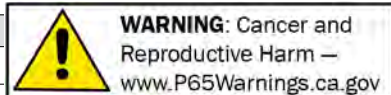

**Fog Light Bulbs, cont.**

- 986942A** ..... **ALL**  
6 in. sealed beam, amber, 6v, #4012A.  
For Unity fog lights. 9.774 -0.15 .....  
**\$35.00 EA** ⚠
- 986942N** ..... **ALL**  
6 in. sealed beam, amber, 6v, #4012A.  
For Unity fog lights. NOS shelf worn.  
9.774 -0 ..... **\$25.00 EA** ⚠



- 987263A** ..... **ALL**  
6 in. sealed beam, amber, 12v, #4412A.  
For Unity fog lights. 9.774 -0.2 .....  
**\$31.50 EA** ⚠

**Bulb Kits**

Complete bulb kits as per original specifications for your vehicle

**Bulb Kits 6 Volt**

- BULB6C** ..... **37-38**  
Car interior, parking and tail light kit.  
0.000 -0.4 ..... **\$20.00 SET** ⚠
- BULB6C** ..... **39**  
Car interior, parking and tail light kit.  
0.000 -0.3 ..... **\$13.75 SET** ⚠
- BULB6C** ..... **40**  
Car interior, parking and tail light kit.  
0.000 -0.3 ..... **\$21.25 SET** ⚠
- BULB6SDL** ..... **41-47**  
Sedan Delivery interior, parking and tail light kit. 0.000 -0.3 ..... **\$26.00 SET** ⚠



- BULB6C** ..... **41-48**  
Car interior, parking and tail light kit.  
0.000 -0.3 ..... **\$22.50 SET** ⚠
- BULB6CVT** ..... **47-48**  
Convertible, interior, parking and tail light kit. 0.000 -0.3 ..... **\$24.25 SET** ⚠
- BULB6SW** ..... **48**  
Wagon, interior, parking and tail light kit.  
0.000 -0.3 ..... **\$22.00 SET** ⚠
- BULB6C** ..... **49-52**  
Car interior, parking and tail light kit.  
0.000 -0.3 ..... **\$27.50 SET** ⚠
- BULB6CVT** ..... **49-52**  
Convertible, interior, parking and tail light kit. 0.000 -0.3 ..... **\$28.00 SET** ⚠
- BULB6SW** ..... **49-52**  
Wagon and Sedan Delivery interior, parking and tail light kit. 0.000 -0.3 ..... **\$32.50 SET** ⚠

**Bulb Kits 6 Volt, cont.**

- BULB6BA** ..... **50-52**  
Bel-Air, interior, parking and tail light kit.  
0.000 -0.3 ..... **\$28.00 SET** ⚠
- BULB6C** ..... **53**  
Car without directional signals factory installed, interior, parking and tail light kit.  
0.000 -0.3 ..... **\$36.00 SET** ⚠
- BULB6CD** ..... **53**  
Car with directional signals factory installed, interior, parking and tail light kit.  
0.000 -0.3 ..... **\$40.50 SET** ⚠
- BULB6C** ..... **54**  
Car without directional signals factory installed, interior, parking and tail light kit.  
0.000 -0.3 ..... **\$31.50 SET** ⚠
- BULB6CD** ..... **54**  
Car with directional signals factory installed, interior, parking and tail light kit.  
0.000 -0.3 ..... **\$37.00 SET** ⚠

**Bulb Kits 12 Volt**

- BULB12C** ..... **37-38**  
Car interior, parking and tail light kit.  
0.000 -0.2 ..... **\$7.75 SET** ⚠
- BULB12C** ..... **39**  
Car interior, parking and tail light kit.  
0.000 -0.2 ..... **\$11.75 SET** ⚠
- BULB12C** ..... **40**  
Car interior, parking and tail light kit.  
0.000 -0.15 ..... **\$16.00 SET** ⚠
- BULB12SDL** ..... **41-47**  
Sedan Delivery interior, parking and tail light kit. 0.000 -0.15 ..... **\$24.50 SET** ⚠
- BULB12C** ..... **41-48**  
Car interior, parking and tail light kit.  
0.000 -0.15 ..... **\$17.25 SET** ⚠
- BULB12CVT** ..... **47-48**  
Convertible, interior, parking and tail light kit. 0.000 -0.15 ..... **\$18.25 SET** ⚠
- BULB12SW** ..... **48**  
Wagon, interior, parking and tail light kit.  
0.000 -0.15 ..... **\$18.50 SET** ⚠
- BULB12C** ..... **49-52**  
Car interior, parking and tail light kit.  
0.000 -0.15 ..... **\$20.50 SET** ⚠
- BULB12CVT** ..... **49-52**  
Convertible, interior, parking and tail light kit. 0.000 -0.15 ..... **\$22.50 SET** ⚠
- BULB12SW** ..... **49-52**  
Wagon and Sedan Delivery interior, parking and tail light kit. 0.000 -0.15 ..... **\$29.00 SET** ⚠
- BULB12BA** ..... **50-52**  
Bel-Air, interior, parking and tail light kit.  
0.000 -0.15 ..... **\$22.50 SET** ⚠
- BULB12C** ..... **53**  
Car without directional signals factory installed, interior, parking and tail light kit.  
0.000 -0.15 ..... **\$35.00 SET** ⚠
- BULB12CD** ..... **53**  
Car with directional signals factory installed, interior, parking and tail light kit.  
0.000 -0.15 ..... **\$35.00 SET** ⚠

**Bulb Kits 12 Volt, cont.**

- BULB12C** ..... **54**  
Car without directional signals factory installed, interior, parking and tail light kit.  
0.000 -0.15 ..... **\$24.00 SET** ⚠
- BULB12CD** ..... **54**  
Car with directional signals factory installed, interior, parking and tail light kit.  
0.000 -0.2 ..... **\$30.00 SET** ⚠

**Bulbs**

-  **110185** ..... **31-39**  
Headlight bulb. 6 volt.  
8.991 -0.4 ..... **\$13.50 EA** ⚠
-  **115273** ..... **ALL**  
High beam indicator & ignition lock lamp #51-6v. 8.991 -0.4 ..... **\$3.50 EA** ⚠
-  **115273A** ..... **ALL**  
High beam indicator & ignition lock lamp #53-12v. 8.991 -0.15 ..... **\$1.25 EA** ⚠
-  **119294** ..... **ALL**  
Dome & stop lamp #87-6v (1 contact) w/ straight pins. 8.991 -0.3 ..... **\$1.50 EA** ⚠
-  **119294A** ..... **ALL**  
Dome & stop lamp #93-12v (1 contact) w/ straight pins. 8.991 -0.4 ..... **\$3.00 EA** ⚠
-  **119434** ..... **ALL**  
Dome lamp #82-6v (2 contacts). 8.991 -0.3 ..... **\$1.75 EA** ⚠
-  **119434A** ..... **ALL**  
Dome lamp #90-12v (2 contacts). 8.991 -0.3 ..... **\$2.50 EA** ⚠
-  **120406** ..... **ALL**  
Dome lamp #88-6v (2 contacts). 8.991 -0.3 ..... **\$1.50 EA** ⚠
-  **120406A** ..... **ALL**  
Dome lamp #94-12v (2 contacts). 8.991 -0.15 ..... **\$1.00 EA** ⚠
-  **125588** ..... **ALL**  
Parking (in head lamp) instrument panel, clock, glove box, dome light, Cabriolet tail light indicator #55-6v. 8.991 -0.3 ..... **\$1.50 EA** ⚠

 **WARNING: Cancer and Reproductive Harm —**  
www.P65Warnings.ca.gov



**Section 100C: Light Bulbs & Sealed Beams, LED Signals**

**Section 110C: Tail Lights, LED Lights, Blue Dots, License Lights, Backup Lights**

**Bulbs, cont.**

-  **125588A.....ALL**  
Parking (in head lamp) instrument panel, clock, glove box, dome light, Cabriolet tail light indicator #57-12v. 8.991-0.3 .. **\$0.75 EA** ⚠
-  **142303.....ALL**  
Tail light or license light. Fits some Sedan Delivery tail lights. #63-6v. 8.991-0.2 ... **\$1.00 EA** ⚠
-  **142303A.....ALL**  
Tail light or license light. Fits some Sedan Delivery tail lights. #98-12v. 8.991-0 ... **\$1.75 EA** ⚠
-  **142306.....ALL**  
Dome lamp (panel) #81-6v (1 contact). 8.991-0.2 .. **\$1.25 EA** ⚠
-  **142306A.....ALL**  
Dome lamp (panel) #89-12v (1 contact). 8.991-0.2 .. **\$1.25 EA** ⚠
-  **142309.....ALL**  
Fog, back up & safety light #1133-6v. 8.991-0.15 . **\$2.25 EA** ⚠
-  **145416.....ALL**  
Tail light & stop light #1154-6v. 8.991-0.4 **\$3.25 EA** ⚠
-  **145416A.....ALL**  
Tail light & stop light (bright) #1157-12v w/ offset pins. 8.991-0.3 **\$1.25 EA** ⚠
-  **145417.....ALL**  
Brake and turn signal. Dual element 6v w/ equal height retaining pins. #1158. 8.991-0.3 **\$2.25 EA** ⚠
-  **145419.....ALL**  
Brake and turn signal. Dual element 12v w/ equal height retaining pins. #1176. 8.991-0.4 **\$3.00 EA** ⚠
-  **145431.....ALL**  
Safety light-spotlight #1323-6v. 8.991-0.15 **\$12.00 EA** ⚠

**Bulbs, cont.**





-  **453138.....ALL**  
Dome lamp #210-6v (2 contacts). 8.991-0.15 **\$2.75 EA** ⚠
-  **453138A.....ALL**  
Dome lamp #1004-12v (2 contacts). 8.991-0.15 ..... **\$1.00 EA** ⚠

**SECTION 110C RESTORATION PARTS**

**Tail Lights**

Tail lights are grouped together by year. Restoration items first followed by street rod parts as direct fit upgrades. Complete assemblies precede individual components

**Tail Light Components 1931-32**

-  **363149.....31-32**  
Chrome housing w/ "Bowtie" rim. Includes bulbs & fasteners. Lens not included. 2.679-0.15 ..... **CALL** ⚠
-  **913823.....31-32**  
Lens 2.682-0.15 ..... **\$11.50 EA** ⚠
-  **913824.....31-32**  
Tail light lens gasket 2.684-0.15 . **\$3.00 EA** ⚠
-  **913825.....31-32**  
Rim-chrome with Bowtie center. 2.681-0.15 .. **\$48.00 EA** ⚠



- 913823BD.....31-35**  
Taillight Lens (glass) W/bowtie 2.682-0 **\$33.00 EA** ⚠

**Tail Light Assembly 1937-38 Black Housing**

Note: 1937-48 tail lights (4in. x 2-3/4in.) below fit all 1937-38 cars, 1939 without trunk and some 1940-48 Sedan Deliveries.



- 927410GL.....37-48**  
Glass Script lens w/ black housing and chrome rim. Left w/ license light. 2.679-0.15 ..... **\$28.50 EA** ⚠
- 927411GR...37-48**  
Glass Script lens w/ black housing and chrome rim. Right. 2.679-0.15 ..... **\$28.50 EA** ⚠





**Tail Light Assembly 1937-38 Blue Dot**

Note: 1937-48 tail lights (4in. x 2-3/4in.) below fit all 1937-38 cars, 1939 without trunk and some 1940-48 Sedan Deliveries.



**927510BL** ..... **37-48**  
Blue dot. Left. Black w/ chrome rim & PLASTIC lens. 2.679 -0.15 ..... **\$39.75 EA** ⚠



**927510DL** ..... **37-48**  
Blue dot. Left. Stainless w/ SCRIPT GLASS lens. 2.679 -0.15 ..... **\$55.25 EA** ⚠



**927511BR** ..... **37-48**  
Blue dot. Right. Black w/ chrome rim & glass lens. 2.679 -0.15 ... **\$41.50 EA** ⚠



**927511DR** ..... **37-48**  
Blue dot. Right. Stainless w/ SCRIPT GLASS lens. 2.679 -0.15 ... **\$45.75 EA** ⚠

**Tail Light Assembly 1937-38 LED Black Housing**

Note: 1937-48 tail lights (4in. x 2-3/4in.) below fit all 1937-38 cars, 1939 without trunk and some 1940-48 Sedan Deliveries.



**927410EL** ..... **37-48**  
LED. Left. Black housing and chrome rim w/ LED license light. 12V 2.679 -0 ..... **CALL** ⚠

**Tail Light Assembly 1937-38 LED Black Housing, cont.**



**927411ER** ..... **37-48**  
LED. Right. Black housing and chrome rim. 12V ONLY. 2.679 -0 ..... **CALL** ⚠

**Tail Light Assembly 1937-38 LED Stainless**

Note: 1937-48 tail lights (4in. x 2-3/4in.) below fit all 1937-38 cars, 1939 without trunk and some 1940-48 Sedan Deliveries.



**927410FL** ..... **37-48**  
LED. Left. Stainless housing and rim w/ LED license light. 12V 2.679 -0.15 ..... **\$79.75 EA** ⚠



**927411FR** ..... **37-48**  
LED. Right. Stainless housing and rim. 12 V 2.679 -0.15 ..... **\$58.00 EA** ⚠

**Tail Light Assembly 1937-38 LED W/ Blue Dot**

Note: 1937-48 tail lights (4in. x 2-3/4in.) below fit all 1937-38 cars, 1939 without trunk and some 1940-48 Sedan Deliveries.



**927410FLB** .. **37-48**  
LED. Left. Stainless housing and rim w/ LED license light. LED blue dot can be lit independently. 12V 2.679 -0.15 ..... **\$77.75 EA** ⚠



**927411ERB** .. **37-48**  
LED. Right. Black housing and chrome rim. LED blue dot can be lit independently. 12V ONLY. 2.679 -0.15 ..... **\$63.25 EA** ⚠

**Tail Light Assembly 1937-38 LED W/ Blue Dot, cont.**



**927411FRB** .. **37-48**  
LED. Right. Stainless housing and rim. LED blue dot can be lit independently. 12 V 2.679 -0.15 ..... **\$74.50 EA** ⚠

**Tail Light Assembly 1937-38 Plastic Lens**

Note: 1937-48 tail lights (4in. x 2-3/4in.) below fit all 1937-38 cars, 1939 without trunk and some 1940-48 Sedan Deliveries.



**927510L** .... **37-48**  
Plastic lens w/ BLACK housing & CHROME RIM. Left w/ license light. 2.679 -0.15 ..... **\$26.50 EA** ⚠



**927511R** ... **37-48**  
Plastic lens w/ BLACK housing & CHROME RIM. Right. 2.679 -0.15 ..... **\$31.00 EA** ⚠

**Tail Light Assembly 1937-38 Stainless**

Note: 1937-48 tail lights (4in. x 2-3/4in.) below fit all 1937-38 cars, 1939 without trunk and some 1940-48 Sedan Deliveries.



**927510CL** ... **37-48**  
Glass Script lens w/ stainless steel housing. Left w/ license light. 2.679 -0.15 ..... **\$37.50 EA** ⚠



**927511CR** .. **37-48**  
Glass Script lens w/ STAINLESS housing. Right. 2.679 -0.15 ..... **\$35.25 EA** ⚠



**WARNING: Cancer and Reproductive Harm** — www.P65Warnings.ca.gov

Chemicals shipped domestic ground only (Lower 48 states only). No international shipping.

**Phone: (360) 816-0211 • (800) 999-CHEV (2438) • www.chevsofthe40s.com**

# Section 110C: Tail Lights, LED Lights, Blue Dots, License Lights, Backup Lights

## Tail Light Lenses 1937-38

Note: 1937-48 tail light lens (4in. x 2-3/4in.) below fit all 1937-38 cars, 1939 without trunk and some 1940-48 Sedan Deliveries.



**5937162** ..... **37-52**  
Plastic lens. 2.682 -0.15  
..... **\$5.00 EA** ⚠



**920626** ..... **37-52**  
Glass (Script) lens.  
2.682 -0.15 .....  
**\$12.50 EA** ⚠



**920626B** ..... **37-52**  
Blue dot in Glass lens. 2.682 -0.15 .....  
**\$15.00 EA** ⚠



**920626LL** ..... **37-52**  
LED conversion. Tail light & license lens w/ integrated LED. LEFT. 12V (must splice wires)  
2.682 -0.15 ..... **\$39.50 EA** ⚠



**920626LLB** ..... **37-52**  
LED conversion. Tail light & license lens w/ integrated LED w/ Blue Dot. LEFT. 12V (must splice wires)  
2.682 -0.15 ..... **\$53.50 EA** ⚠



**920626LRB** ..... **37-52**  
LED conversion. Tail light w/ integrated LED and blue dot. RIGHT. 12V (must splice wires)  
2.682 -0.15 ..... **\$39.50 EA** ⚠



**920626LS** ..... **37-52**  
LED conversion. Tail light & license lens w/ integrated LED and sequential turn signals. LEFT. 12V (must splice wires)  
2.682 -0.15 ..... **\$47.00 EA** ⚠



**920626RS** ..... **37-52**  
LED conversion. Tail light w/ integrated LED with sequential turn signals. RIGHT. 12V (must splice wires)  
2.682 -0.15 .....  
**\$35.00 EA** ⚠

## Tail Light Components 1937-38

Note: 1937-52 tail light parts (4in. x 2-3/4in.) below fit 1937-38 cars, 1939 without trunk and some 1940-52 Sedan Delivery & Wagons.



**5933830** ..... **37-52**  
Rim. Stainless.  
2.681 -0.15 ..... **\$7.00 EA** ⚠



**920625** ..... **37-52**  
Gasket for lens. 2.684 -0  
..... **\$1.25 EA** ⚠



**923315** ..... **37-52**  
Screws for tail light rim. Stainless steel (2 pcs).  
2.688 -0.3 ..... **\$0.75 SET** ⚠



**920626R** ..... **37-53**  
Reflector. Brighten up tail light for improved safety  
Stainless  
2.682 -0.2 ..... **\$12.00 PR** ⚠



**142303** ..... **ALL**  
Tail light or license light. Fits some Sedan Delivery tail lights.  
#63-6v. 8.991 -0.2 ..  
**\$1.00 EA** ⚠



**142303A** ..... **ALL**  
Tail light or license light. Fits some Sedan Delivery tail lights.  
#98-12v. 8.991 -0 ..  
**\$1.75 EA** ⚠

## Tail Light Assembly 1939 Chrome



**916877C** ..... **39-52**  
Glass lens, complete assembly w/ CHROME housing. 2.679 -0.15 .....  
**\$64.75 EA** ⚠

## Tail Light Assembly 1939 Chrome LED



**916877CLA** ..... **39-52**  
Chrome housing w/ Amber LED & lens. 12V 2.679 -0.15 ..... **\$80.00 EA** ⚠

## Tail Light Assembly 1939 Chrome LED, cont.



**916877CLAC** ..... **39-52**  
Chrome housing w/ Amber LED & Clear lens. 12V 2.679 -0.15 ..... **\$80.00 EA** ⚠



**916877CLR** ..... **39-52**  
LED. Chrome left housing w/ Red lens left side. 12V left side 2.679 -0.15 .....  
**\$75.00 EA** ⚠



**916877CLRC** ..... **39-52**  
LED. Red LED, clear lens. Chrome housing w/ Red LEDs. 12V left or right 2.679 -0.15 .....  
**\$80.00 EA** ⚠



**916877CRR** ..... **39-53**  
LED. Chrome right housing w/ Red lens. 12V right side 2.679 -0 ..... **\$75.00 EA** ⚠

## Tail Light Assembly 1939 Primer



**916877** ..... **39-52**  
Glass lens, complete assembly w/ PRIMERED housing. Left or Right. 12V dual element bulb. 2.679 -0.15 .....  
**\$77.50 EA** ⚠

Returns require a return authorization number—call first. • Product pricing & availability subject to change.

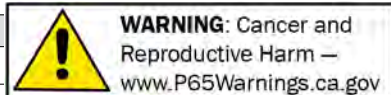



**Tail Light Assembly 1939 Primer LED**



**916877LA** ..... **39-52**  
Primered housing, Amber LED & lens. 12V  
2.679 -0.15 ..... **\$80.00 EA** ⚠



**916877LAC** ..... **39-52**  
Primered housing w/ Amber LED & clear  
lens. 12V left or right 2.679 -0.15 .....  
**\$80.00 EA** ⚠



**916877LR** ..... **39-52**  
LED. Primer housing w/ Red lens left side.  
12V left side 2.679 -0.15 ..... **\$80.00 EA** ⚠



**916877LRC** ..... **39-52**  
LED. Red LED, clear lens. Primer housing  
w/ Red LEDs. 12V 2.679 -0.15 .....  
**\$80.00 EA** ⚠



**916878LR** ..... **39-52**  
LED. Primer housing w/ Red lens right  
side. 12V right side 2.679 -0.15 .....  
**\$80.00 EA** ⚠

**Tail Light Lenses 1939**



**920696** ..... **39-52**  
GLASS lens (Fits 3 in. housing). 2.682 -0.2  
..... **\$12.00 EA** ⚠



**920696B** ..... **39-52**  
BLUE DOT in GLASS lens (Fits 3 in.  
housing). 2.682 -0.15 ..... **\$15.50 EA** ⚠



**920696CL** ..... **39-53**  
LED fits 3 in. housing. Red. Fits 39-52 car  
or 47-53 trucks. 12V 2.682 -0.15 .....  
**\$46.75 EA** ⚠



**920696CLA** ..... **39-53**  
LED fits 3 in. housing. Amber. Fits 39-52  
car or 47-53 trucks. 12V 2.682 -0.15 .....  
**\$44.25 EA** ⚠



**920696L** ..... **39-53**  
LED fits 3 in. housing. Red. Fits 39-52 car  
or 47-53 trucks. 12V 2.682 -0.15 .....  
**\$37.50 EA** ⚠

**Tail Light Components 1939-52**



**916879** ..... **39-52**  
Pad for 3in. round  
tail light (2 pcs)  
rubber 2.660 -0  
..... **\$18.00 PR** ⚠

**Tail Light Components 1939-52, cont.**



**921872** ..... **39-52**  
Gasket (3in. round)  
(2 pcs) 2.684 -0.2  
..... **\$3.50 SET** ⚠



**923322** ..... **39-52**  
Rim. Chrome (3in.  
round) 2.681 -0.15  
..... **\$7.00 EA** ⚠

**Tail Light Assembly 1940 Black Housing**



**927067** ..... **40**  
Chrome rim, black  
housing. Use for  
left or right side  
(reversible lens).  
2.679 -0.15  
..... **CALL** ⚠

**Tail Light Assembly 1940 LED**



**927067L** ..... **40**  
LED. Chrome rim,  
black housing &  
polycarbonate lens.  
Use for left or right  
side (reversible  
lens). 12V 2.679 -0  
..... **CALL** ⚠

**Tail Light Assembly 1940 LED Surface Mount**



**927067LF** ..... **40**  
LED. Flat surface  
mount. Complete  
housing with chrome  
bezels. 12V 2.679 -0.15  
..... **\$116.75 PR** ⚠

**Tail Light Components 1940**



**3654478** ..... **40**  
Pads. Non-beaded  
(paper). 2.660 -0.3  
..... **\$8.00 PR** ⚠



**3654478A** ..... **40**  
Pads. Beaded rubber  
(not originally used).  
2.660 -0.15 .....  
**\$24.75 PR** ⚠



**5930215** ..... **40**  
Gasket for tail light lens  
(2 pcs). 2.684 -0.3  
..... **\$6.50 PR** ⚠

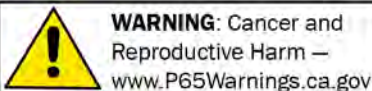

Chemicals shipped domestic ground only (Lower 48 states only). No international shipping.

Phone: (360) 816-0211 • (800) 999-CHEV (2438) • www.chevsofthe40s.com



# Section 110C: Tail Lights, LED Lights, Blue Dots, License Lights, Backup Lights

## Tail Light Lenses 1940, cont.



**4920214A** ..... 40  
Glass lens. For original  
taillight housings.

2.682 -0.15 ..... **\$7.50 EA**

**4920214AL** ..... 40

Plastic lens with LED  
lights, 1157 plug. 12V  
2.682 -0.15 .....

**\$34.00 EA** ⚠

**4920214B** ..... 40

Blue dot in GLASS lens.  
For original taillight  
housings. 2.682 -0.15

..... **\$14.25 EA** ⚠

**4920214R** ..... 40

Glass lens for  
reproduction housings.  
2.682 -0.15 .....

**\$10.50 EA** ⚠

**4920214RB** ..... 40

Glass lens. 2.682 -0.15

..... **\$20.00 EA** ⚠



## Tail Light 1940-48 Sedan Delivery



**5930342** ..... 40-48

Lens-t-light(glass)  
Sedan Delivery.back  
Door (NOS) 2.682 -0.15

..... **CALL** ⚠

**5930343** ..... 40-48

Gasket. Sedan Delivery  
back door 2.684 -0.4

**\$7.75 EA** ⚠

**664288B** ..... 40-48

Pads. Sedan Delivery  
back door 2.670 -0.15

..... **\$15.00 EA** ⚠



## Tail Light Components 1941-48



**3657835** ..... 41-48

Mounting Pad. Exc Fleetline 4-door.  
2.660 -0.4 .....

**\$18.00 PR** ⚠



**3662260** ..... 41-48

Mounting Pad. Fleetline 4-door. 2.660 -0.15

..... **\$111.75 PR** ⚠

## Tail Light Components 1941-48, cont.



**5931381** ..... 41-48

Rim. Stainless. 2.681 -0.2

**\$10.25 EA** ⚠



**5931433** ..... 41-48

Gasket-exc Sedan  
Delivery & Wagon (2  
pcs). 2.684 -0.15 .....

**\$6.50 PR** ⚠



**5937582** ..... 41-48

Screw speed nut (2 pcs)  
2.688 -0.3 .....

**\$7.50 SET** ⚠



**5941434** ..... 41-48

Screws. Stainless steel  
(4 pcs). 2.688 -0.4 .....

**\$1.75 SET** ⚠

## Tail Light Assembly 1941-48



**927116** ..... 41-48

W/ Glass lens. Right side complete  
assembly. Includes pad. Exc Fleetline  
4-door, Sedan Delivery & Wagon.

2.679 -0.15 .....

**\$29.50 EA** ⚠



**927117** ..... 41-48

W/ Glass lens. Left side complete  
assembly. Includes pad. Exc Fleetline  
4-door, Sedan Delivery & Wagon.

2.679 -0.15 .....

**\$29.50 EA** ⚠

## Tail Light Assembly 1941-48 Blue Dot



**927116B** ..... 41-48

W/ Blue dot in glass lens. Right side  
complete assembly w/ pad #3657835  
.Exc Fleetline 4-door, Sedan Delivery &

Wagon 2.679 -0.15 .....

**\$42.50 EA** ⚠

## Tail Light Assembly 1941-48 Blue Dot, cont.



**927117B** ..... 41-48

W/ Blue dot in Glass lens. Left side  
complete assembly w/ pad #3657835.  
Exc Fleetline 4-door, Sedan Delivery &

Wagon. 2.679 -0.15 .....

**\$45.25 EA** ⚠

## Tail Light Assembly 1941-48 LED



**927116L** ..... 41-48

LED. Right side. Complete assembly w/  
stainless rim. 12V. Exc Fleetline 4-door,  
Sedan Delivery & Wagon. 2.679 -0.15 .....

**\$54.25 EA** ⚠



**927116LC** ..... 41-48

LED. Right side, clear lens w/ red LED.  
Complete assembly w/ stainless rim. 12V.  
Exc Fleetline 4-door, Sedan Delivery &

Wagon. 2.679 -0.15 .....

**\$35.00 EA** ⚠



**927117L** ..... 41-48

LED. Left side. Complete assembly w/  
stainless rim. 12V. Exc Fleetline 4-door,  
Sedan Delivery & Wagon. 2.679 -0.15 .....

**\$49.00 EA** ⚠

**Tail Light Assembly 1941-48 LED, cont.**



**927117LC** ..... **41-48**  
LED. Left side, clear lens w/ red LED. Complete assembly w/ stainless rim. 12V. Exc Fleetline 4-door, Sedan Delivery & Wagon. 2.679 -0.15 ..... **\$35.00 EA** ⚠

**Tail Light Assembly 1941-48 LED Surface Mount**



**927116LF** ..... **41-48**  
LED. Complete assemblies. For applications with a flat surface mount. Stainless rim. 12V. 2.679 -0.15 ..... **\$101.25 PR** ⚠

**Tail Light Lenses 1941-48**



**5931432** ..... **41-48**  
Script Glass lens. Exc Fleetline 4-door, Sedan Delivery & Wagon 2.682 -0.2 ..... **\$13.00 EA** ⚠



**5931432B** ..... **41-48**  
Blue dot in Glass lens. Exc Fleetline 4-door, Sedan Delivery & Wagon. 2.682 -0.15 ..... **\$17.25 EA** ⚠



**5931432L** ..... **41-48**  
LED tail light. Epoxy coated, fully sealed electronics. 39 super bright LEDs. 12V Exc Fleetline 4-door, Sedan Delivery & Wagon. 2.682 -0.15 ..... **\$35.00 EA** ⚠

**Tail Light Assembly 1941-48 LED Surface Mount**



**5931432LB** ..... **41-48**  
LED tail light with blue dot. Epoxy coated, fully sealed electronics. 37 super bright LEDs. 12V Exc Fleetline 4-door, Sedan Delivery & Wagon. 2.682 -0.15 ..... **\$42.00 EA** ⚠

**Tail Light Assembly 1949-50**

Note: 1949-50 tail light assemblies use a 1950 style lens.



**927577** ..... **49-50**  
Chrome complete assembly w/ reflector. Exc SDL & WGN. 2.679 -0 ..... **CALL** ⚠



**927577S** ..... **49-50**  
Stainless complete assembly w/ reflector. Exc SDL & WGN. 2.679 -0.15 ..... **CALL** ⚠

**Tail Light Assembly 1949-50 LED**

Note: 1949-50 tail light assemblies use a 1950 style lens.



**927577L** ..... **49-50**  
LED. Chrome complete assembly w/ reflector. Exc SDL & WGN. 12V 2.679 -0 ..... **CALL** ⚠



**927577SL** ..... **49-50**  
LED. Stainless complete assembly w/ reflector. Exc SDL & WGN. 12V 2.679 -0.15 ..... **\$156.00 PR** ⚠

**Tail Light Components 1949-50**



**3688069** ..... **49-50**  
Pads. Exc Sedan Delivery & Wagon. 2.660 -0.2 ..... **\$12.50 PR** ⚠



**5937858** ..... **49-50**  
Lens gasket (2 pcs). 2.684 -0.15 ..... **\$5.50 PR** ⚠

**5937863S** ..... **49-50**  
Stainless steel rim w/ reflector. Exc Sedan Delivery & Wagon 2.681 -0.15 ..... **\$68.00 PR** ⚠

**Tail Light Components 1949-50, cont.**



**5938323** ..... **49-50**  
Reflector. Below tail light guide script. 2.689 -0.2 ..... **\$6.75 EA** ⚠

**Tail Light Lenses 1949-50**



**5937861** ..... **49**  
Plastic lens. 2.682 -0.15 ..... **\$5.50 EA** ⚠



**5937821B** ..... **49-50**  
Blue dot in GLASS lens (glass lens orig. on '50). 2.682 -0.15 ..... **\$16.75 EA** ⚠



**5937861L** ..... **49-50**  
Plastic red tail light lens with 16 red LEDs. 12 volt. 2.682 -0.15 ..... **\$34.50 EA** ⚠



**5939421** ..... **50**  
Glass lens. 2.682 -0.15 ..... **\$9.25 EA** ⚠



**5939421B** ..... **50**  
Plastic lens. 2.682 -0 ..... **CALL** ⚠

**Tail Light Assembly 1951-52**



**927883** ..... **51-52**  
Assembly with glass lens, rim & reflector. 2.679 -0.15 ..... **\$45.25 EA** ⚠

**Tail Light Assembly 1951-52 LED**



**927883SL** ..... **51-52**  
LED. Complete housing. 12V 2.679 -0.15 ..... **\$73.75 EA** ⚠

**Tail Light Components 1951-52**



**3695952** ..... **51-52**  
Tail light pads. 2.660 -0.2 ..... **\$14.50 PR** ⚠



**5940037** ..... **51-52**  
Lens gasket (2 pcs). 2.684 -0.15 ..... **\$3.00 PR** ⚠



**5943455** ..... **51-52**  
Reflector, below tail light. 2.689 -0.15 ..... **\$6.00 EA** ⚠



**5943455AL** ..... **51-52**  
Led Lit Reflector Below Tail Light Amber 2.679 -0 ..... **\$15.00 EA** ⚠

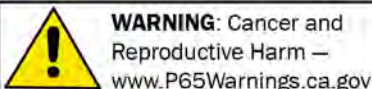

**WARNING: Cancer and Reproductive Harm** —  
www.P65Warnings.ca.gov

Chemicals shipped domestic ground only (Lower 48 states only). No international shipping.

**Phone: (360) 816-0211 • (800) 999-CHEV (2438) • www.chevsofthe40s.com**



**Tail Light Components 1951-52, cont.**



**5943455RL . . . . .51-52**  
Led Lit Reflector Below  
Tail Light Red 2.679 -0.2  
..... **\$15.00 EA** ⚠



**5943455WL . . . . .51-52**  
Led Lit Reflector Below  
Tail Light White 2.679 -0  
..... **\$15.00 EA** ⚠



**5951091 . . . . .51-52**  
Rim w/ reflector. Exc  
Sedan Delivery &  
Wagon 2.681 -0.15 ..  
**\$54.25 PR** ⚠



**5606PAD . . . . .ALL**  
Auxiliary Light Rubber  
Pad 2.679 -0.3 .....

**Tail Light Lenses 1951-52**



**5940038 . . . . .51-52**  
Glass lens. 2.682 -0.15  
..... **\$8.25 EA** ⚠



**5940038B . . . . .51-52**  
Blue dot in glass lens.  
2.682 -0.15 .....



**5940038L . . . . .51-52**  
Lens w/ LED lights.  
Plugs into stock socket.  
12V 2.682 -0.15 .....

**Tail Light Assembly 1949-52 Black Housing Blue Dot**

Note: 1949-52 tail lights (4in. x 2-3/4in.) below fit some Sedan Deliveries & Wagons.



**927074BL . . . . .49-52**  
Blue dot in glass script  
lens, black housing  
complete assembly &  
chrome rim. Left side  
w/ license light. 2.679 -0.15 .. **\$45.00 EA** ⚠



**985608BR . . . . .49-52**  
Blue dot in glass script  
lens, black housing  
complete assembly &  
chrome rim. Right side.  
2.679 -0.15 .....

**Tail Light Assembly 1949-52 Black Housing Glass Lens**

Note: 1949-52 tail lights (4in. x 2-3/4in.) below fit some Sedan Deliveries & Wagons.

Flat on Back



**927074GL . . . . .49-52**  
Glass script lens, black housing complete  
assembly & chrome rim. Left side w/  
license light. 2.679 -0.15 .. **\$43.00 EA** ⚠



**985608GR . . . . .49-52**  
Glass script lens, Black housing & chrome  
rim. Right side. 2.679 -0.15 .. **\$45.00 EA**  
⚠

**Tail Light Assembly 1949-52 Black Housing Plastic Lens**

Note: 1949-52 tail lights (4in. x 2-3/4in.) below fit some Sedan Deliveries & Wagons.



**927074L . . . . .49-52**  
Plastic lens, Black  
housing complete  
assembly & chrome rim.  
Left side w/ license  
light. 2.679 -0.15 .....



**985608R . . . . .49-52**  
Plastic lens, black  
housing complete  
assembly & chrome rim.  
Right side. 2.679 -0.15 .....

**Tail Light Assembly 1949-52 Chrome Housing**

Note: 1949-52 tail lights (4in. x 2-3/4in.) below fit some Sedan Deliveries & Wagons.

**92707SCL . . . . .49-52**  
Glass script lens, Stainless housing  
complete assembly & Stainless rim. Left  
side w/ license light. 2.679 -0 .....

**Tail Light Assembly 1949-52 Chrome Housing, cont.**



**985608CR . . . . .49-52**  
Glass script lens, chrome housing  
complete assembly & chrome rim. Right  
side. 2.679 -0.15 .....

**98560SCR . . . . .49-52**  
Glass script lens, Stainless housing  
complete assembly & Stainless rim. Right  
side. 2.679 -0 .....

**Tail Light Assembly 1949-52 Chrome Housing Blue Dot**

Note: 1949-52 tail lights (4in. x 2-3/4in.) below fit some Sedan Deliveries & Wagons.



**927074DL . . . . .49-52**  
Blue dot in glass script lens, chrome  
housing complete assembly & chrome rim.  
Left side w/ license light. 2.679 -0.3 .....



**985608DR . . . . .49-52**  
Blue dot in glass script lens, CHROME  
housing complete assembly & chrome rim.  
Right side. 2.679 -0.15 .....

**Tail Light Assembly 1949-52 LED Chrome Housing**

Note: 1949-52 tail lights (4in. x 2-3/4in.) below fit some Sedan Deliveries & Wagons.



**927074HL . . . . .49-52**  
LED with chrome  
housing. Left side w/  
LED license light. 12V  
2.679 -0 .....



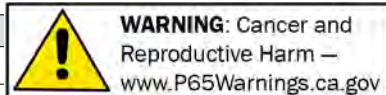

**985608HR . . . . .49-52**  
LED with chrome  
housing. Right hand  
side. 12V 2.679 -0 .....





**Tail Light Components 1949-52**

Note: 1949-52 tail light components (4in. x 2-3/4in.) below fit some Sedan Deliveries & Wagons.

 **5933830.....37-52**  
Rim. Stainless.  
2.681 -0.15 ..... **\$7.00 EA** ⚠️

 **920625.....37-52**  
Gasket for lens. 2.684 -0  
..... **\$1.25 EA** ⚠️

 **923315.....37-52**  
Screws for tail light rim.  
Stainless steel (2 pcs).  
2.688 -0.3 ..... **\$0.75 SET** ⚠️

 **920626R.....37-53**  
Reflector. Brighten up  
tail light for improved  
safety Stainless  
2.682 -0.2 ..... **\$12.00 PR** ⚠️

 **142303.....ALL**  
Tail light or license light.  
Fits some Sedan  
Delivery tail lights.  
#63-6v. 8.991 -0.2 ...  
**\$1.00 EA** ⚠️

 **142303A.....ALL**  
Tail light or license light.  
Fits some Sedan  
Delivery tail lights.  
#98-12v. 8.991 -0 ...  
**\$1.75 EA** ⚠️

**Tail Light Rim 1953**





**5943401 ..... 53**  
Door, chrome. 2.681 -0.15 ..... **\$99.50 PR** ⚠️

**Tail Light Lenses 1953**

 **5943403..... 53**  
PLASTIC upper lens  
(outer). 2.682 -0.15 ...  
**\$9.00 EA** ⚠️

 **5943404..... 53**  
PLASTIC backup light  
lens. 2.697 -0.15 .....  
**\$7.00 EA** ⚠️

 **5943406..... 53**  
PLASTIC center (Brake,  
Turn, Tail). 2.682 -0.15  
..... **\$8.25 EA** ⚠️

 **5943406B ..... 53**  
BLUE DOT in PLASTIC  
center lens. 2.682 -0.15  
..... **\$15.00 EA** ⚠️

**Tail Light Lenses 1953, cont.**

 **5944070..... 53**  
PLASTIC. Upper, inner  
lens 2.682 -0.15 .....  
**\$5.50 EA** ⚠️

**Tail Light LED Lenses 1953**

 **5943403B ..... 53**  
BLUE DOT in PLASTIC  
upper lens. 2.682 -0.15  
..... **\$10.00 EA** ⚠️

 **5943403L..... 53**  
LED. Top turn signal  
(red). 12V 2.682 -0.15  
..... **\$26.00 EA** ⚠️

 **5943404L..... 53**  
LED. Backup light lens.  
2.697 -0.15 .....  
**\$45.25 EA** ⚠️

 **5943406L..... 53**  
LED. Center, Brake/  
Marker. 12V 2.682 -0.15  
..... **\$31.75 EA** ⚠️

**Tail Light Gasket 1953**





**5943407 ..... 53**  
Tail light lens gasket (6 pcs). 2.684 -0.15  
..... **\$9.50 SET** ⚠️

**Tail Light 1953-54**

 **5941662.....53-54**  
Seals. Tail light  
assembly to body.  
2.660 -0.2 ..... **\$36.75 PR** ⚠️

**Tail Light Assembly 1954**

 **897627 ..... 54**  
Complete assembly  
with rim, sockets,  
reflector and  
lenses. 12V  
2.679 -0.15  
..... **\$98.75 EA** ⚠️

 **897627L ..... 54**  
Complete assembly  
with rim, sockets,  
reflector and LED  
lenses. 2.679 -0.15  
..... **\$188.00 EA** ⚠️

**Tail Light Components 1954, cont.**

 **5941671..... 54**  
Reflector around tail  
light & backup lens.  
2.689 -0.15  
..... **\$12.50 EA** ⚠️

 **5941674..... 54**  
Lens gasket (4 pcs).  
2.684 -0.15 .....  
**\$8.00 SET** ⚠️





**5941746..... 54**  
Door, chrome. 2.681 -0.15 ..... **\$83.00 PR** ⚠️

 **5941746M ..... 54**  
Moulding. Center of  
lens. 2.681 -0.15 .....  
**\$13.75 PR** ⚠️

**Tail Light Lenses 1954**

 **5941679..... 54**  
PLASTIC upper lens.  
2.682 -0.15 ..... **\$8.25 EA** ⚠️

 **5941679B ..... 54**  
BLUE DOT in upper  
PLASTIC lens. 2.682 -0.15  
..... **\$15.50 EA** ⚠️

 **5941679L..... 54**  
LED. Upper lens. 12V  
2.682 -0.15 .....  
**\$36.25 EA** ⚠️

 **5941699..... 54**  
PLASTIC backup light  
lens. 2.697 -0.15 .....  
**\$7.25 EA** ⚠️

 **5941699L..... 54**  
LED. PLASTIC  
backup light w/ lens.  
2.697 -0.15  
..... **\$44.00 EA** ⚠️

 **5941701..... 54**  
Upper Inner - Used  
2.682 -0 ..... **CALL** ⚠️

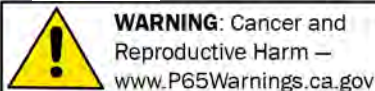

Chemicals shipped domestic ground only (Lower 48 states only). No international shipping.

Phone: (360) 816-0211 • (800) 999-CHEV (2438) • www.chevsofthe40s.com



# Section 110C: Tail Lights, LED Lights, Blue Dots, License Lights, Backup Lights

## Tail Light Lenses 1954, cont.



**5941701D** ..... 54  
Plastic.  
Reproduction of  
original Lee bubble.  
1-3/4" deep,  
smooth 1 piece  
design (no back up  
light lens). 2.682-0.15

..... **\$88.00 PR** ⚠



**5941701S** ..... 54  
Plastic.  
Reproduction of  
original Lee bubble.  
Shallow 1", smooth  
1 piece design  
(no back up light  
lens). Size: 9-3/4" x  
3-5/8". 2.682-0.15

..... **\$89.75 PR** ⚠

## Blue Dots



**920626A** ..... **ALL**  
Glass w/ chrome ring (you install).  
2.682-0.15 ..... **\$8.75 PR** ⚠



**920627A** ..... **ALL**  
Chrome with amber Bowtie cut out. 2.682-0  
..... **CALL** ⚠



**920627B** ..... **ALL**  
Chrome with blue Bowtie cut out. 2.682-0  
..... **CALL** ⚠

## License Bracket



**595565A** ..... **37-39**  
License on left tail light. 2.662-0  
**CALL** ⚠



**604288** ..... **39-48**  
License plate-39 on trunk and 40-48  
Sedan Delivery on back door 2.662-0.15  
..... **\$45.00 EA** ⚠

## Tail Light Stand



**595566** ..... **37-38**  
Coupe, Cabriolet, left 2.662-0  
**\$85.25 EA** ⚠



**602328** ..... **37-38**  
Coupe, Cabriolet, right 2.662-0.15  
**\$65.25 EA** ⚠



**602328B** ..... **37-38**  
Coupe, Cabriolet (pair) 2.662-0  
**\$140.50 L&R** ⚠



**595067** ..... **37-48**  
Reinforcement plate in  
trunk 2.664-0.15  
**\$40.00 PR** ⚠



**595068** ..... **37-48**  
Taillight stand  
reinforcement plate in  
trunk. 2.664-0.15  
**\$57.25 PR** ⚠

## Tail Light Stand, cont.



**602330** ..... **37-48**  
37-38 Sedans w/ trunk, 37-48 Sedan  
Delivery (pair) 2.662-0.15  
**\$189.25 L&R**  
⚠

## Tail Light Stand Mounting Pad



**594954** ..... **37-38**  
Mounting pad (Coupe & Cabriolet)  
2.660-0.15 ..... **\$28.25 PR** ⚠



**594969** ..... **37-38**  
Mounting pad (Sedan w/ trunk) 2.660-0.15  
**\$17.50 PR** ⚠



**594970** ..... **37-39**  
Mounting pad (Sedan, no trunk) 2.660-0.15  
**\$11.50 PR** ⚠

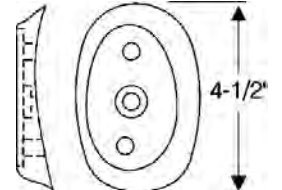

**595045** ..... **37-48**  
Mounting pad left (Sedan Delivery)  
2.673-0.15 ..... **\$70.50 EA** ⚠

**Tail Light Stand Mounting Pad, cont.**

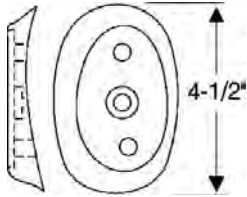

**595046.....37-48**  
Mounting pad right (Sedan Delivery)  
2.673 -0.15 ..... **\$85.25 EA** ⚠



**3692354 .....49-52**  
Mount pad (Sedan Delivery) 2.660 -0.15  
**\$15.50 PR** ⚠

**Grommet Tail Light License Wire**



**922285.....37-38**  
Tail light or headlight  
wire thru body. 9.775 -0.2  
..... **\$13.25 EA** ⚠



**3650018.....37-39**  
Tail light wire thru body  
9.775 -0.15 .....  
**\$15.25 EA** ⚠



**3650019..... 39**  
Tail light wire (in floor)  
Coupe & Sedans w/  
trunk 9.775 -0.15 .....  
**\$3.25 EA** ⚠

**License Light 1937-52**

Fits all 1937-38 cars, 1939 without trunk and  
some 1940-52 sedan deliveries & wagons

**827925.....37-52**  
Lens retainer clips &  
screws. 2.691 -0.15 .....  
**\$15.00 SET** ⚠



**920634.....37-52**  
Glass lens. 2.685 -0 ..... **\$35.00 EA** ⚠



**920634P .....37-52**  
Plastic lens. 2.685 -0.2 ... **\$5.00 EA** ⚠

**License Light 1937-52**



**920808.....37-52**  
Lens gasket. 2.686 -0.15 .. **\$2.50 EA** ⚠

**License Light 1939-41**

**827925..... 39**  
Lens retainer clips &  
screws. 2.691 -0.15 .....  
**\$15.00 SET** ⚠

**916882A..... 39**  
Pad to trunk (not  
originally used)  
2.702 -0.15 .....  
**\$14.75 EA** ⚠

**923386..... 39**  
Lens, Trunk Mount  
2.709 -0.3 .....  
**\$20.00 EA** ⚠

**923387..... 39**  
Lens gasket. License  
light. Trunk mount.  
2.686 -0.3 ..... **\$3.00 EA**

**3663784.....39-48**  
Trunk lid & Sedan Del  
back door. License  
bracket support post  
pad. 2.673 -0.3 .....  
**\$3.75 EA** ⚠

**4089552.....39-48**  
Trunk lid wire grommet.  
9.775 -0.15 .....  
**\$2.50 EA** ⚠

**411189..... 40**  
Pad to trunk lid.  
2.702 -0.15 .....  
**\$10.00 EA** ⚠

**5930151 .....40-41**  
License light lens cover "only" chrome.  
2.706 -0.3 ..... **\$16.00 EA** ⚠

**922042.....40-41**  
License Light Lens (exc  
Sedan Delivery &  
Station Wagon)  
2.709 -0.3 .....  
**\$11.25 EA** ⚠

**923079.....40-41**  
Gasket for lens.  
2.707 -0.3 ..... **\$3.00 EA**

**5930358.....40-48**  
Gasket for license light  
lens. SDL back door.  
2.686 -0.2 ..... **\$3.00 EA**

**License Light 1939-41, cont.**

**827925.....40-48**  
Lens retainer clips &  
screws, SDL, back door.  
2.691 -0.15 .....  
**\$15.00 SET** ⚠

**3658431..... 41**  
Pad to trunk lid.  
2.702 -0.15 .....  
**\$16.00 EA** ⚠

**License Light 1942-48**

**3663784.....39-48**  
Trunk lid & Sedan Del  
back door. License  
bracket support post  
pad. 2.673 -0.3 .....  
**\$3.75 EA** ⚠

**4089552.....39-48**  
Trunk lid wire grommet.  
9.775 -0.15 .....  
**\$2.50 EA** ⚠

**5930358.....40-48**  
Gasket for license light  
lens. SDL back door.  
2.686 -0.2 ..... **\$3.00 EA**

**827925.....40-48**  
Lens retainer clips &  
screws, SDL, back door.  
2.691 -0.15 .....  
**\$15.00 SET** ⚠

**3663703.....42-48**  
Pad to trunk lid (exc  
Fleetline 2-door).  
2.702 -0.15 .....  
**\$22.50 EA** ⚠

**3663782.....42-48**  
Pad to trunk lid.  
Fleetline 2-door.  
2.702 -0.15 .....  
**\$33.00 EA** ⚠

**5932761.....42-48**  
Lens 2.709 -0.3 .....  
**\$24.00 EA** ⚠

**5932762.....42-48**  
Lens Gasket 2.707 -0.15  
..... **\$2.50 EA** ⚠

**License Light 1949-54**

**5937940.....49-50**  
Lens Gasket Exc Sedan  
Delivery & Wagon (2  
pcs) 2.707 -0.15 .....  
**\$7.00 PR** ⚠

**3688071.....49-54**  
Pad, license light,  
49-50 exc Sedan  
Delivery & Wagon, also fits 54 Sedan  
Delivery & Wagon 2.702 -0.15 .....  
**\$14.50 PR** ⚠

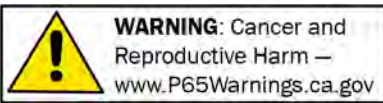

Chemicals shipped domestic ground only (Lower 48 states only). No international shipping.

**Phone: (360) 816-0211 • (800) 999-CHEV (2438) • www.chevsofthe40s.com**

110C



**License Light 1949-54, cont.**



**5939876.....51-52**  
 Lens Gasket 2.707 -0.3  
 ..... **\$5.75 EA** ⚠



**5940480.....51-52**  
 Lens. 2.709 -0.3  
 ..... **\$16.00 EA** ⚠



**3696314.....53-54**  
 Grommet w/ 1/4in.  
 hole for license plate  
 wire thru 11/64 hole in  
 body 9.775 -0.15  
 ..... **\$6.75 EA** ⚠



**5939870.....53-54**  
 Grommet-Sedan  
 Delivery & Wagon  
 2.707 -0.15  
 ..... **\$1.75 EA** ⚠

**Back Up Light Assembly 1937-38**



**985296.....37-38**  
 An original accessory 2.697 -0  
 ..... **CALL** ⚠

**Back Up Light 1937-41**



**922756.....37-41**  
 Lens, glass 2.697 -0  
 ..... **CALL** ⚠



**922757.....37-41**  
 Lens gasket 2.697 -0.15  
 ..... **\$3.75 EA** ⚠



**984719B.....41**  
 Pad base 2.697 -0.15  
 ..... **\$4.25 EA** ⚠

**Back Up Light 1942-46**

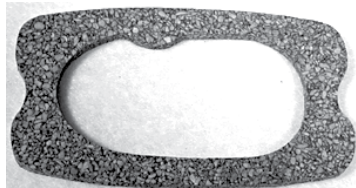

**5931549A.....42-46**  
 Lens gasket 2.590 -0.15  
 ..... **\$3.75 EA** ⚠

**Back Up Light 1942-46, cont.**



**5933130.....42-46**  
 Lens, glass - not as original 2.697 -0.3  
 ..... **\$9.75 EA** ⚠

**Back Up Light 1947-48**



**5931452.....47-48**  
 Lens gasket 2.697 -0.2  
 ..... **\$4.25 EA** ⚠



**986095A.....47-48**  
 Pad, bracket to body 2.697 -0.15  
 ..... **\$11.25 EA** ⚠

**Back Up Light 1950-52**



**5935956.....50-52**  
 Back up lens gasket 2.697 -0.15  
 ..... **\$6.25 PR** ⚠



**5938297.....50-52**  
 Lens, glass includes gasket #5935956  
 2.697 -0.15  
 ..... **\$23.00 PR** ⚠

**Back Up Light Harness**



**5933127A.....42-48**  
 Includes sockets 2.697 -0  
 ..... **\$76.00 EA** ⚠



**986408A.....51-52**  
 Does not include light  
 sockets. 2.697 -0  
 ..... **\$76.00 EA** ⚠



**986663A.....53-54**  
 Does not include light  
 sockets. 2.697 -0.15  
 ..... **\$79.75 EA** ⚠

**Switch**



**924160.....ALL**  
 Fog light, backup  
 light, etc, rotary.  
 Clamps to dash  
 bottom. 9.774 -0.2  
 ..... **\$23.00 EA** ⚠

**Odds & Ends**

**920696U.....39-53**

Tail light lens, glass (Fits 3 in. housing)  
 2.682 -0.4 ..... **\$15.00 EA** ⚠

**927410U.....40-48**

Tail light, 4in. x 2-3/4in. Fits SDL. Left  
 side. 2.682 -0.4 ..... **\$125.00 EA** ⚠

**985719N.....41**

Back Up Light (nos) Chrome No Lens  
 2.697.000 -0 ..... **\$125.00 EA** ⚠

**5931381P.....41-48**

Tail light rim, painted (NOS) 10.000 -0.4  
 ..... **\$20.00 EA** ⚠

**5931432N.....41-48**

Tail light lens. Exc 4-door Fleetline, Sedan  
 Delivery, Wagon (NORS) 2.682 -0  
 ..... **\$25.00 EA** ⚠

**5931432PU.....41-48**

Tail light lens. Plastic. Exc 4-door FL, SDL  
 & WGN. (Used) 2.682 -0 ..... **\$20.00 EA** ⚠

**5931432U.....41-48**

Tail light lens. Exc 4-door Fleetline, Sedan  
 Delivery, Wagon 2.682 -0.4 ..... **\$15.00 EA** ⚠

**927565UB.....41-48**

Tail light Bucket Left side (Used) Exc FL/  
 SDL/ SW 2.682 -0.4 ..... **\$15.00 EA** ⚠

**919044.....41-52**

Glass lens for station  
 wagon. 4-3/16in. O.D.,  
 round. (Shelf worn)  
 2.682 -0.1 ..... **\$40.00 EA**



# Section 120C: Fuel System, Gas Tanks, Gas Tank Sending Units, Fuel Pumps, Carburetors, Air Cleaners & Intake Manifolds

## SECTION 120C STREET ROD PARTS

### Fuel Pump-Electric



**5592627E . . . . ALL**  
Fuel will flow through pump when turned off so pump can be used just to prime or full time. Inline, 6 volt. (30 GPH, 4-6 PSI). 3.900 -0.15

**5593256E . . . . ALL**  
Fuel will flow through pump when turned off so pump can be used just to prime or full time. Inline, 12 volt. (30 GPH, 4-6 PSI). 3.900 -0.15



**5593256F . . . . ALL**  
Intank 12v electric fuel pump rated at 15 GPH and max 3 PSI. 3.900 -0.15

**5593256G . . . . ALL**  
Intank 12v electric fuel pump rated at 20-35 GPH and 4-6 PSI. 3.900 -0.15



**5593256H . . . . ALL**  
Intank 12v electric fuel pump rated at 20-35 GPH and 3-5 PSI. 3.900 -0.15

### Fenton Intake 2 Carb



**3687540B . . . . .50-62**  
Install kit for Fenton intake manifold. Includes bellcrank, throttle rod & spring. 3.579 -0.2 . . . . .**\$56.50 EA** ⚠

### Fenton Intake 2 Carb, cont.



**3836071E . . . . .50-62**  
2 carb intake kit. Includes linkage and fuel kit to install from existing fuel line. For 235ci & 261ci (261ci uses 235ci carbs, w/ 2-15/16" bolt spacing). No grinding required to fit headers. 3.265 -0.15 . . . . .**CALL** ⚠

### Offenhauser Intake 2 Carb



**3836071B . . . . .37-53**  
Dual carb. Fits 216ci. Uses 216ci carbs with 2-5/8in. bolt spacing. Linkage included (carb only!). 3.265 -0.15 . . . . .**\$692.00 SET** ⚠

**3836071A . . . . .50-62**  
Dual carb. Fits 235ci. 261ci uses 235ci carbs with 2-15/16in. bolt spacing. Linkage included (carb only!). 3.265 -0 . . . . .**\$692.00 SET** ⚠

### Offenhauser Intake 3 Carb



**3836071D . . . . .37-53**  
Triple carb. Fits 216ci. Uses 216ci carbs with 2-5/8in. bolt spacing. Linkage included (carb only). 3.265 -0.15 . . . . .**\$325.00 SET** ⚠

**3836071C . . . . .50-62**  
Triple carb. Fits 235ci. 261ci uses 235ci carbs with 2-15/16in. bolt spacing. Linkage included (carb-only). 3.265 -0.15 . . . . .**\$601.25 SET** ⚠

### Heat Kit For Split Exhaust Manifolds



**838574B . . . . .37-53**  
Heat kit. Split headers to intake. 216ci only. 3.640 -0.2 . . . . .**\$44.25 EA** ⚠



**838573B . . . . .50-62**  
Heat kit. Split headers to intake. 235ci only. 3.640 -0.2 . . . . .**\$44.25 EA** ⚠

### Air Cleaner Assembly



**1528725L . . . . ALL**  
Louvered. Complete w/ 4in. filter and base clamp. 3.410 -0 . . . . .**\$12.75 EA** ⚠



**1528725ML . . . ALL**  
Complete with 4in. filter, chrome louvered housing, base clamp & 3 prong spinner. Smooth housing. 2-5/8in. neck. 3.410 -0.15 . . . . .**\$26.00 EA** ⚠



**1528725MS . . . ALL**  
Complete with 4in. filter, base clamp & 3 prong spinner. Smooth housing. 2-5/8in. neck. 3.410 -0 . . . . .**CALL** ⚠



**1528725S . . . . ALL**  
Smooth. Complete w/ 4in. filter and base clamp. 3.410 -0 . . . . .**\$12.75 EA** ⚠



**AIR95 . . . . . ALL**  
Stellings & Hellings 9-1/2" dia. Stainless steel. Complete w/ filter and base clamp. Fits carbs with 2-1/4" top. 3.410 -0.15 . . . . .**\$75.00 EA** ⚠



**OTB-4750 . . . . ALL**  
Finned Unpolished Fits 2-1/4" Rochester, Carter, Zenith Carbs -0 . . . . .**\$189.00 EA** ⚠



**OTB-4750P . . . . ALL**  
Finned Polished Fits 2-1/4" Rochester, Carter, Zenith Carbs -0 . . . . .**\$185.50 EA** ⚠

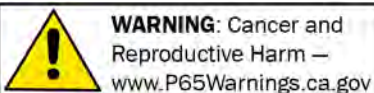

**WARNING: Cancer and Reproductive Harm** — www.P65Warnings.ca.gov

Chemicals shipped domestic ground only (Lower 48 states only). No international shipping.

Phone: (360) 816-0211 • (800) 999-CHEV (2438) • www.chevsofthe40s.com

120C



# Section 120C: Fuel System, Gas Tanks, Gas Tank Sending Units, Fuel Pumps, Carburetors, Air Cleaners & Intake Manifolds

## Air Cleaner Assembly, cont.



**OTB-4760.....ALL**  
Ribbed Edge  
Unpolished Fits  
2-1/4" Rochester,  
Carter, Zenith  
Carbs -0  
..... **\$165.50 EA** ⚠

**OTB-4760P.....ALL**  
Ribbed Edge Polished Fits 2-1/4"  
Rochester, Carter, Zenith Carbs -0  
..... **\$185.50 EA** ⚠



**OTB-4770.....ALL**  
Mini Mohawk  
Unpolished Fits  
2-1/4" Rochester,  
Carter, Zenith  
Carbs -0  
..... **\$165.50 EA** ⚠



**OTB-4770P.....ALL**  
Mini Mohawk  
Polished Fits 2-1/4"  
Rochester, Carter,  
Zenith Carbs -0  
..... **\$185.50 EA** ⚠

## Air Cleaner Adapter



**1528725A.....ALL**  
2-5/8in. to 2-5/16in to  
fit air cleaners. 3.410 -0.2  
..... **\$1.75 EA** ⚠

## Air Cleaner Clamp



**1528725C.....ALL**  
Replacement for base  
of 4in. air cleaner  
(#1528725S &  
#1528725L). 3.410 -0.15  
..... **\$1.25 EA** ⚠

## Clamp



**120521A.....ALL**  
5/16 in, insulated  
bolt-on strap. For wire  
or tube (4 pcs).  
8.950 -0.4 ..... **\$3.25 SET** ⚠

## Line Clamp - Stainless

Lokar Line Clamps are stainless steel and come with machine and sheetmetal screws. For securing electric, brake, fuel or transmission lines.

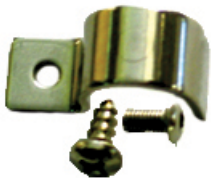

**13274.....ALL**  
3/16" single (12 clamps). 8.950 -0.15  
..... **\$19.75 SET** ⚠

## Line Clamp - Stainless, cont.

**13275.....ALL**  
3/16" x 3/8" double combination (6  
clamps). 8.950 -0.15 ..... **\$19.75 SET** ⚠

**13276.....ALL**  
3/16" x 3/16" double (6 clamps).  
8.950 -0.15 ..... **\$18.00 SET** ⚠

**13277.....ALL**  
1/4" single (12 clamps). 8.950 -0.15 ...  
..... **\$22.00 SET** ⚠

**13278.....ALL**  
5/16" single (12 clamps). 8.950 -0.15 ...  
..... **\$19.75 SET** ⚠

**13279.....ALL**  
3/8" single (12 clamps). 8.950 -0.15 ...  
..... **\$19.75 SET** ⚠

**13280.....ALL**  
1/2" single (12 clamps). 8.950 -0.15 ...  
..... **\$19.75 SET** ⚠

**13281.....ALL**  
5/8" single (8 clamps). 8.950 -0.15 .....  
..... **\$22.00 SET** ⚠

**13282.....ALL**  
3/4" single (8 clamps). 8.950 -0.15 .....  
..... **\$18.00 SET** ⚠

**13283.....ALL**  
7/8" single (8 clamps). 8.950 -0.15 .....  
..... **\$18.00 SET** ⚠

**13284.....ALL**  
5/16" x 3/8" double combination (6  
clamps). 8.950 -0.15 ..... **\$18.00 SET** ⚠



**13285.....ALL**  
1/4" x 1/4" double (6 clamps). 8.950 -0.15  
..... **\$18.00 SET** ⚠

**13286.....ALL**  
5/16" x 5/16" double (6 clamps).  
8.950 -0.15 ..... **\$19.75 SET** ⚠

**13287.....ALL**  
3/8" x 3/8" double (6 clamps). 8.950 -0.15  
..... **\$19.75 SET** ⚠

**13288.....ALL**  
1/2" x 1/2" double (6 clamps). 8.950 -0.15  
..... **\$18.00 SET** ⚠

**13289.....ALL**  
5/8" x 5/8" double (4 clamps). 8.950 -0.15  
..... **\$19.75 SET** ⚠

**13290.....ALL**  
3/4" x 3/4" double (4 clamps). 8.950 -0.15  
..... **\$20.50 SET** ⚠

**13291.....ALL**  
7/8" x 7/8" double (4 clamps). 8.950 -0.15  
..... **\$19.75 SET** ⚠

## Fuel Line Fitting

**TAIFITTING.....ALL**  
3/8" To 5/16" -0 ..... **\$8.00 EA** ⚠

## Gas Tank-Stainless Steel

Oversize shipping charges apply on all gas tanks. Please call for rate.

**593537.....37**  
Exc 3-passenger Coupe, Sedan Delivery  
top fill. 3.001 -0 ..... **\$898.00 EA** ⚠  
**3653589.....37-40**

Fits 3-passenger Coupe, Sedan Delivery.  
40-1/4" x 19-3/4" 5-3/4" tall. 3.001 -0  
..... **\$898.00 EA** ⚠

**3653518.....40**  
Exc 3-passenger Coupe, Sedan Delivery.  
3.001 -0 ..... **\$898.00 EA** ⚠

**3658078.....41-48**  
Fits 3-passenger Coupe & Sedan  
Delivery. 18 gal. 3.001 -0.1 .. **\$898.00 EA**  
⚠

**3694851.....49-52**  
Exc Wagon, Sedan Delivery. 3.001 -0 ...  
..... **\$898.00 EA** ⚠



**3694851SS.....49-52**  
Die stamped. 3/8" pickup tube with  
reducer to 5/16" for either 6 or 8 cyl use.  
Fits cars (exc Wagon, Sedan Delivery).

29-1/4in. x 21-1/2in. x 8-1/2in. Stainless  
Steel 3.001 -0.15 ..... **\$454.75 EA** ⚠

**3698467.....53-54**  
Exc Wagon, Sedan Delivery. 3.001 -0 ...  
..... **\$895.00 EA** ⚠



**3702862SS.....53-54**  
Die stamped stainless steel. 3/8" pickup  
tube with reducer to 5/16" for either 6 or  
8 cyl use. Fits Cars (exc. Wagon & Sedan  
Delivery). Painted silver. 3.001 -0.15 .....  
..... **\$454.75 EA** ⚠



# Section 120C: Fuel System, Gas Tanks, Gas Tank Sending Units, Fuel Pumps, Carburetors, Air Cleaners & Intake Manifolds

## Gas Tank-Polyethylene

Oversize shipping charges apply on all gas tanks. Please call for rate.  
ALL polyethylene tanks come with straps.



- 593537P** ..... **37**  
W/ fill hose, baffle, tunnel & roll over vent valve (exc 3-passenger Coupe, Sedan Delivery), top fill (requires sending unit #1516250). 3.001-0.15 **\$299.25 EA** ⚠
- 3650116P** ..... **38-39**  
Neck on end (exc 3-passenger Coupe, Sedan Delivery) (requires sending unit #1516250). 3.001-0.15 **\$309.50 EA** ⚠
- 3847302PB** ..... **41-48**  
18 gal w/ RIGHT SIDE fill hose, baffle tunnel & roll over vent valve (exc. 3-passenger Coupe & Sedan Delivery).. Requires sending unit #1516250. Tank size 34-1/2" x 18" x 8-1/2" w/o tire well. 3.001-0.15 **\$330.50 EA** ⚠
- 3847320P** ..... **41-48**  
16 gal w/ RIGHT SIDE fill hose, baffle tunnel & roll over vent valve (exc. 3-passenger Coupe & Sedan Delivery). Requires sending unit #1516250. 28-1/2" x 18" x 8-1/2". 3.001-0.15 **\$305.50 EA** ⚠
- 3847320PB** ..... **41-48**  
16 gal w/ LEFT SIDE fill hose, baffle tunnel & roll over vent valve (exc. 3-passenger Coupe & Sedan Delivery). Requires sending unit #1516250. 28-1/2" x 18" x 8-1/2". 3.001-0.15 **\$315.50 EA** ⚠
- 3847320PL** ..... **41-48**  
18 gal w/ LEFT SIDE fill hose, baffle tunnel & roll over vent valve (exc. 3-passenger Coupe & Sedan Delivery). Requires sending unit #1516250)gas tank. 3.001-0.15 **\$275.25 EA** ⚠
- 3694851P** ..... **49-52**  
W/ fill hose drivers side fill w/ baffle tunnel & roll over vent valve exc 3-pass coupe, sedan delivery & wagon (requires sending unit #1516250)gas tank. 3.001-0.15 **\$300.25 EA** ⚠
- 3702862P** ..... **53-54**  
W/ fill hose, baffle tunnel, straps & roll over vent valve (exc Sedan Delivery & Wagon). (requires sending unit #1516250) 3.001-0.15 **\$315.50 EA** ⚠

## Gas Tank-Steel for Fuel Injection



- 3847320F** ..... **41-48**  
Steel tank with provision for fuel injection pump. 16 Gal. 27.5in. x 19.5in. x 7.5in. exc 3-pass coupe & sedan delivery. 3.001-0.15 **\$287.75 EA** ⚠



shown painted for display purposes

- 3694851F** ..... **49-52**  
Steel tank with provision for fuel injection pump. 29-1/4" x 21-1/4" x 9-1/4". 1 inch deeper than stock for 2 gallons extra capacity. 18 gallons. 3.001-0.15 **\$281.25 EA** ⚠



- 3694851K** ..... **49-52**  
18 gallon Steel tank with provision for fuel injection pump. Comes with straps and hardware. 3/8" pickup tube. 28" x 20" x 9-1/2" tall (plus outside flange). Note: Oversize Shipping. 3.001-0.15 **\$201.50 EA** ⚠



- 3702862F** ..... **53-54**  
Steel tank with provision for fuel injection pump. 16 Gal. 27.5in. x 19.5in. x 7.5in. (Except Wagon & Sedan Delivery) 3.001-0.15 **\$281.25 EA** ⚠

## Gas Tank-Steel for Fuel Injection, cont.



- 3702862K** ..... **53-54**  
18 gallon Steel tank with provision for fuel injection pump. Comes with straps and hardware. 3/8" pickup tube. 28" x 20" x 9-1/4" tall (plus outside flange). Note: Oversize Shipping

## Fuel Stabilizer



- 111801** ..... **ALL**  
STA-BIL stabilizer. 8 oz bottle treats 20 gallons, for one year. 3.001-0 **\$8.25 EA** ⚠



- 111801B** ..... **ALL**  
STA-BIL fuel stabilizer. 32 oz bottle treats 80 gallons, for one year. 3.001-0.15 **\$21.00 EA** ⚠

## Gas Tank Restoration Kit



- PORTANK** ..... **ALL**  
Portank, Restore your tanks. Cleaner, metal prep, sealer (Slosh) and instructions. 3.001-0.15 **\$95.00 KIT** ⚠

## Gas Tank Sealer



- 3657942C** ..... **ALL**  
Gas tank sealer slosh, seals gas tank. Alcohol and Ethanol proof. Not for use with (MEK) Methyl Ethyl Ketone. 3.001-0.15 **\$35.25 QT** ⚠

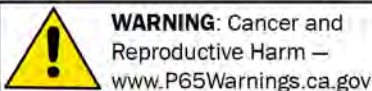

Chemicals shipped domestic ground only (Lower 48 states only). No international shipping.

Phone: (360) 816-0211 • (800) 999-CHEV (2438) • www.chevsofthe40s.com

120C



# Section 120C: Fuel System, Gas Tanks, Gas Tank Sending Units, Fuel Pumps, Carburetors, Air Cleaners & Intake Manifolds

## Gas Tank Cleaner



**PORCLEAN . . . . .ALL**  
1 quart.  
MARINE-CLEAN  
cleans and  
degreases in one  
application without  
leaving residues,  
noxious fumes or  
flammable solvents.  
It makes petroleum-

based cleaners almost obsolete because  
it can be diluted with water up to 3, 4,  
5 and even 10 times its volume while  
remaining more potent than other  
cleaners. 3.001 -0.15

..... **\$13.25 EA** ⚠

## Metal Prep

Provides adhesion for POR-15 paint (Sect.  
15) on aluminum and shiny polished metal  
surfaces. Etches metal and leaves a zinc  
phosphate coating. Non-caustic, non-  
corrosive, non-toxic & non-flammable.



**PORMETAL . . . . .ALL**  
Etches Metal  
and Leaves a  
Zinc Phosphate  
Coating. Provides  
the best adhesion  
for POR-15 on any  
metal surface.

Water based,  
OSHA approved biodegradable solution.

3.001 -0.15

..... **\$20.75 QT** ⚠

## Gas Tank Sending Unit



**1516250 . . . . .ALL**  
GM up to 1964 W/ screws, gasket &  
instructions, correct ohms (0-30) for early  
GM gauges, up to 1964 (6v or 12v).  
Adjustable float (plastic) height. 3.107 -0.15

..... **\$25.00 EA** ⚠

## Voltage Reducer



**1119004 . . . . .ALL**  
Reducer 12v to 6v. Best  
for fuel gauge. Hi-Tech  
w/ constant volts.

2.500 -0.15

..... **\$23.50 EA** ⚠

## Air Filter Element



**1528725E . . . . .ALL**  
4 in. replacement for air  
cleaner assemblies  
(#1528725S,  
1528725L,

1528725ML and 1528725MS). 3.410 -0.2

..... **\$10.00 EA** ⚠



**AIR95F . . . . .ALL**  
Replacement Air Filter  
For AIR95 3.410 -0.15

..... **\$16.75 EA** ⚠

## SECTION 120C RESTORATION PARTS

### Gas Tank-Steel Original Style

Oversize shipping charges apply on all gas  
tanks. Please call for rate.

Note: For restoration or hi-tech street rod.



**593537V . . . . . 37**

Die stamped. 14 Gal. 37.5in. x 16.25in. x  
7.5in. 3/8in. OD pickup tube (Exc  
3-passenger Coupe, Sedan Delivery).

3.001 -0.15 ..... **\$313.75 EA** ⚠

**3653589S . . . . . 37-40**

Fits 3-passenger Coupe, Sedan Delivery.  
42" x 21-1/2 x 5-3/4 3.001 -0.15

..... **\$379.00 EA** ⚠



**3650116V . . . . . 38-39**

Die stamped. 14 Gal. 37.5in. x 16.25in. x  
7.5in. 3/8in. OD pickup tube (Exc  
3-passenger Coupe, Sedan Delivery).

3.001 -0.15 ..... **\$313.75 EA** ⚠



**3653518V . . . . . 40**

Die stamped. 14 Gal. 39.75in. x 16.25in. x  
7.5in. 3/8in. OD pickup tube (Exc  
3-passenger Coupe, Sedan Delivery).

3.001 -0.15 ..... **\$313.75 EA** ⚠

## Gas Tank-Steel Original Style, cont.



**3847320S . . . . . 41-48**

Die stamped. 3/8" pickup tube with  
reducer to 5/16" for either 6 or 8 cyl use.  
(Exc 3-passenger Coupe, Sedan Delivery).  
Painted silver. 3.001 -0.15 .. **\$318.00 EA**  
⚠



**3694851S . . . . . 49-52**

Die stamped. 3/8" pickup tube with  
reducer to 5/16" for either 6 or 8 cyl use.  
Fits cars (exc Wagon, Sedan Delivery).  
29-1/4in. x 21-1/2in. x 8-1/2in. Painted  
silver. 3.001 -0.15 ..... **\$318.00 EA** ⚠

**3705975 . . . . . 49-54**

Die stamped. 3/8" pickup tube with  
reducer to 5/16" for either 6 or 8 cyl use.  
Fits Wagon & Sedan Delivery. Painted  
silver. 3.001 -0.15 ..... **\$382.25 EA** ⚠



**3702862S . . . . . 53-54**

Die stamped. 3/8" pickup tube with  
reducer to 5/16" for either 6 or 8 cyl use.  
Fits Cars (exc. Wagon & Sedan Delivery).  
Painted silver. 3.001 -0.15 .. **\$318.00 EA**  
⚠

## Gas Tank-Stainless Steel

**3847320SS . . . . . 41-48**

Die stamped stainless steel. 3/8" pickup  
tube with reducer to 5/16" for either 6 or  
8 cyl use. (Exc 3-passenger Coupe, Sedan  
Delivery). 3.001 -0 ..... **\$454.75 EA** ⚠

## Gas Tank Straps

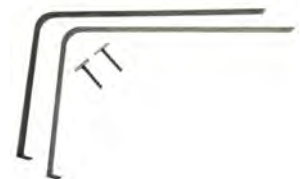

**3658213 . . . . . 37**

Includes T-bolts 3.022 -0.15 .. **\$35.00 PR**  
⚠

Returns require a return authorization number—call first. • Product pricing & availability subject to change.



**WARNING:** Cancer and  
Reproductive Harm —  
www.P65Warnings.ca.gov

# Section 120C: Fuel System, Gas Tanks, Gas Tank Sending Units, Fuel Pumps, Carburetors, Air Cleaners & Intake Manifolds

## Gas Tank Straps, cont.



**3658213C** ..... **37-39**  
T-bolts 3.022-0.15 ...  
**\$13.00 PR** ⚠️

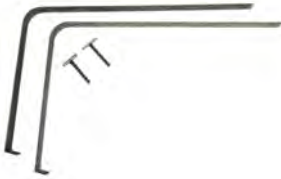

**3658213** ..... **38-39**  
(except 3-passenger Coupe, Coupe Pickup  
& Sedan Delivery) Includes T-bolts  
3.022-0.15 ..... **\$39.00 PR** ⚠️



**CG-MS** ..... **40**  
This is a pair of tank straps for holding  
your gas tank in.

\*NOTE\*  
We recommend using new cushion straps  
when installing.  
They can be found as our part #603955A  
3.001-0.15 ..... **\$28.75 PR** ⚠️

**3658213** ..... **41-48**  
41-48 (exc 3-passenger Coupe, Pickup &  
Sedan Delivery) w/ carriage bolts & hex  
nuts 3.022-0.15 ..... **\$37.00 PR** ⚠️

**3658213SS** ..... **41-48**  
41-48 (exc 3-passenger Coupe, Pickup &  
Sedan Delivery) w/ carriage bolts & hex  
nuts 3.022-0.15 ..... **\$65.00 PR** ⚠️

**3658213** ..... **49-54**  
49-54, exc Sedan Delivery & Wagon, w/  
carriage bolts 3.022-0.15 ..... **\$27.50 PR** ⚠️



**3658213A** ..... **ALL**  
Universal, no hardware  
included. 42" L x 1-3/8"  
W. 3.022-0.15 .....  
**\$21.75 PR** ⚠️

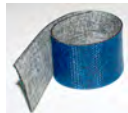

**603955A** ..... **ALL**  
Tank strap cushion  
(108 in.) 10.696-0.15  
..... **\$10.50 SET** ⚠️

## Gas Cap



**595857** ..... **28-57**  
Non-locking, polished  
stainless steel (as  
original), w/ inside  
flange. (28-52 Car  
28-57 Truck) 3.028-0.15 ..... **\$11.25 EA** ⚠️

**595857C** ..... **28-57**  
Non-locking, Show Quality Chrome (as  
original), w/ inside flange. (28-52 Car  
28-57 Truck) 3.028-0 ..... **\$13.00 EA** ⚠️

## Gas Cap, cont.



**595857L** ..... **28-57**  
Locking, chrome w/  
inside flange. Not  
original item. (28-52  
Cars, 28-57 Trucks)

3.028-0.15 ..... **\$20.50 EA** ⚠️



**985076** ..... **38-57**  
Original "GM" locking  
gas cap. With GM logo.  
(28-52 Car 28-57 Truck)  
3.028-0.15 .....

**\$59.00 EA** ⚠️



**985076A** ..... **38-57**  
Locking with Bowtie.  
Inside flange. (28-52  
Car 28-57 Truck)  
3.028-0.15 .....

**\$47.75 EA** ⚠️



**3698470** ..... **53-56**  
Original style, w/  
outside flange 3.028-0.15  
..... **\$8.00 EA** ⚠️



**987347A** ..... **53-57**  
Locking w/ red painted  
stripe, for outside flange  
3.028-0.15 .....  
**\$50.00 EA** ⚠️

## Gas Filler Door



**3681093** ..... **49**  
Bumpers, round  
12.944-0 ..... **\$9.25 PR**  
⚠️



**4581256** ..... **50-55**  
Bumpers w/ screws  
12.944-0.2 .....  
**\$9.00 SET** ⚠️

## Gas Door Guard



**4583006** ..... **49-50**  
Stainless steel 12.944-0.15 ..... **\$26.75 EA**  
⚠️



**986552** ..... **51-52**  
Stainless steel 12.944-0.15 ..... **\$21.25 EA**  
⚠️

## Gas Door Guard, cont.



**986789** ..... **53-54**  
Stainless steel 12.944-0.15 ..... **\$17.75 EA**  
⚠️

## Gas Filler Neck Seal



**593527** ..... **37-48**  
Filler neck to floor pan,  
3-1/2 x 1-3/8 ring,  
Business Coupe &  
Sedan Delivery exc 40  
3.008-0.15 ..... **\$67.50 PR** ⚠️

**\$67.50 PR** ⚠️

## Gas Filler Grommet



**3650545** ..... **35-40**  
37-40 Sedan Delivery &  
3-passenger Coupe,  
35-36 exc Sedan  
Delivery & 3-passenger  
Coupe 3.008-0.4 ..... **\$10.75 EA** ⚠️

**\$10.75 EA** ⚠️

**3650545E** ..... **35-40**  
35-36 cars (exc Sedan  
Delivery & 3-passenger  
Coupe) and 37-40  
Sedan Delivery & 3-passenger Coupe.  
3.008-0.15 ..... **\$52.75 EA** ⚠️

**\$52.75 EA** ⚠️



**3653774** ..... **37-48**  
Exc Sedan Delivery &  
3-passenger Coupe  
3.008-0.2 ..... **\$12.50 EA**  
⚠️

**\$12.50 EA** ⚠️



**3653774E** ..... **37-48**  
Exc Sedan Delivery &  
3-passenger Coupe  
3.008-0.15 .....

**\$58.75 EA** ⚠️



**3658166** ..... **41-48**  
Sedan Delivery &  
3-passenger Coupe  
3.008-0.15 .....

**\$51.75 EA** ⚠️



**3692553** ..... **49**  
In inner quarter panel  
exc Sedan Delivery &  
Wagon 3.008-0.15 ..  
**\$58.25 EA** ⚠️

**\$58.25 EA** ⚠️



**3702162** ..... **49-54**  
Sedan Delivery &  
Wagon 3.008-0 .....  
**CALL** ⚠️

**CALL** ⚠️



**3702162A** ..... **49-54**  
Fits Sedan Delivery &  
Wagon. Superior  
product! 3.008-0.15 ..  
**\$71.75 EA** ⚠️

**\$71.75 EA** ⚠️



**WARNING:** Cancer and  
Reproductive Harm —  
www.P65Warnings.ca.gov

Chemicals shipped domestic ground only (Lower 48 states only). No international shipping.

Phone: (360) 816-0211 • (800) 999-CHEV (2438) • www.chevsofthe40s.com

120C



# Section 120C: Fuel System, Gas Tanks, Gas Tank Sending Units, Fuel Pumps, Carburetors, Air Cleaners & Intake Manifolds

## Gas Tank Filler Neck



- 3658523** ..... **41-48**  
Exc Bus Cpe and SDL 3.003 -0.15 .....  
**\$36.75 EA** ⚠  
**593544** ..... **47-48**  
Exc Sedan Delivery & 3-passenger Coupe  
3.003-0 ..... **\$190.50 EA** ⚠

## Gas Tank Filler Hose



- 3654570** ..... **37**  
GM script with clamps exc Sedan Delivery  
& Business Coupe. 3.003 -0.15 .....  
**\$11.25 SET** ⚠  
**3688488** ..... **38-54**  
GM script w/ clamps, fits 1938-48  
Passenger (exc Business Coupe) and  
1949-54 Sedan Delivery and Station  
Wagon 3.003 -0.2 ..... **\$14.00 SET** ⚠  
**3692531** ..... **49-52**  
Filler & vent hose w/ GM script & clamps.  
Exc Wagon & Sedan Delivery 3.003 -0.2 .....  
**\$13.00 SET** ⚠

## Gas Filler Hose Clamp



- 3834073B** ..... **37**  
Hose clamp. 2-1/4 in. I.D. for gas filler  
hose. Original, exc Sedan Delivery &  
Business Coupe (2 pcs) 3.003 -0.2 .....  
**\$4.00 SET** ⚠  
**3834073A** ..... **38-54**  
Hose clamp. 2in. i.d. for gas filler hose.  
Original, exc 38-48 3-passenger Coupe &  
Sedan Delivery, 49-54 fits Sedan Delivery  
& Wagon only 3.003 -0.2 ..... **\$5.00 SET** ⚠  
**111619** ..... **49-52**  
Hose clamp. 1-7/8 in. i.d. for gas filler  
hose. Original, exc. Sedan Delivery &  
Wagon (2 pcs) 1.166 -0.15 ..... **\$4.50 SET** ⚠

## Hose



- 609742** ..... **ALL**  
1/2" I.D. Sold by the inch 3.003 -0.4 ...  
**\$0.50 IN** ⚠

## Gas Tank Sending Unit



- 1516280** ..... **41-52**  
With gasket, correct ohms for Chev gauges  
0-30 (6v or 12v). Exc 49-52 SDL & WGN.  
3.107 -0.15 ..... **\$52.00 EA** ⚠



- 1518032** ..... **49-54**  
With gasket, correct ohms for GM gauges  
0-30 (6v or 12v). SDL & WGN only.  
3.107 -0.15 ..... **\$45.25 EA** ⚠



- 1518225** ..... **53-54**  
With gasket, correct ohms for Chev gauges  
0-30 (6v or 12v). Pass exc. SDL & WGN.  
3.107 -0.15 ..... **\$44.00 EA** ⚠

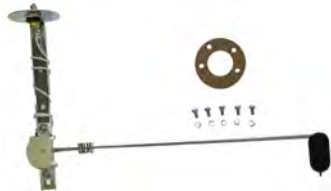

- 1516250** ..... **ALL**  
GM up to 1964 W/ screws, gasket &  
instructions, correct ohms (0-30) for early  
GM gauges, up to 1964 (6v or 12v).  
Adjustable float (plastic) height. 3.107 -0.15  
..... **\$25.00 EA** ⚠

## Gas Tank Sending Unit Gasket



- 1516061** ..... **31-54**  
Cork gasket, gas tank  
sending unit 3.112 -0.3  
..... **\$2.25 EA** ⚠

## Gas Tank Sending Unit Gasket, cont.



- 1516061R** ..... **31-54**  
Rubber gasket, gas tank  
sending unit 3.112 -0.15  
..... **\$2.25 EA** ⚠

## Screws



- 1516061A** ..... **ALL**  
Screws for sending unit  
(zinc). 3.112 -0.4 ...  
**\$7.00 SET** ⚠

## Float



- 3708954** ..... **37-54**  
Brass, for gas tank  
sending unit. 3.107 -0.15  
..... **\$7.00 EA** ⚠



- 1516250A** ..... **ALL**  
Cork. For gas tank  
sending unit (2 floats).  
3.107 -0.15 .....  
**\$7.50 SET** ⚠



- 1516250R** ..... **ALL**  
Plastic. For gas tank  
sending unit (2 floats).  
3.107 -0 ..... **CALL** ⚠

## Terminal Boot



- 1516252** ..... **ALL**  
Sending unit wire boot.  
3.107 -0.15 .....  
**\$31.75 EA** ⚠

## Fuel Filter



- 986640** ..... **33-56**  
Complete assembly  
w/ glass bowl and  
filter. 3.890 -0.15  
..... **\$27.00 EA** ⚠



- 986640LAC** . **33-56**  
Genuine AC.  
Complete assembly  
w/ glass bowl &  
filter. 3.890 -0.15  
..... **\$63.00 EA** ⚠

## Fuel Filter Element



- 5451937** ..... **33-56**  
Replacement element  
(not for fuel pump filter).  
3.890 -0.15 ..... **\$6.50 EA**  
⚠



# Section 120C: Fuel System, Gas Tanks, Gas Tank Sending Units, Fuel Pumps, Carburetors, Air Cleaners & Intake Manifolds

## In Line Filter Bowl Gasket



**5452822.....37-57**  
Gasket, inline filter bowl. 2-7/64" 3.890 -0.2  
..... **\$2.00 EA** ⚠

## Glass Bowl



**1523094.....37-55**  
Fuel pump (1-15/16" I.D., 2-1/4" O.D.) w/ gasket 3.903 -0 .....  
**CALL** ⚠

## Fuel Pump Gasket



**5590039.....37-56**  
Fuel pump filter bowl gasket, 2-1/4in. o.d. cork 3.904 -0.3 .....  
**\$3.50 EA** ⚠

## Fuel Pump Mounting Gasket



**838263.....37-57**  
Fuel pump mounting gasket 3.932 -0.15 ..  
**\$2.00 EA** ⚠

## Fuel Pump



**1523429 ....37-51**  
W/ glass bowl, includes gasket. 3.900 -0.2  
..... **\$135.00 EA** ⚠



**5592627 ....37-51**  
W/ metal bowl, includes gasket. 3.900 -0  
..... **CALL** ⚠



**5592627G...52-57**  
W/ glass bowl, includes gasket. 3.900 -0.2  
..... **\$125.00 EA** ⚠



**5592627M ..52-57**  
W/ metal bowl, includes gasket. 3.900 -0  
..... **CALL** ⚠

## Fuel Pump W/ Vacuum Pump



**5591457 ....37-51**  
W/ vacuum pump (glass bowl) stops slow wipers, original accessory. Also fits GMC, includes gasket. 3.900 -0.15  
..... **CALL** ⚠



**5591457M ..37-51**  
W/ vacuum pump (metal bowl) includes gasket. 3.900 -0  
..... **CALL** ⚠



**5592675 ....52-57**  
W/ vacuum pump (glass bowl) stops slow wipers, original accessory. 3.900 -0.15  
..... **CALL** ⚠



**5592675M ..52-57**  
W/ vacuum pump (metal bowl) stops slow wipers, original accessory. 3.900 -0  
..... **CALL** ⚠

## Fuel Pump Rebuild Kits



**5591844 .....37-51**  
W/ vacuum pump 3.901 -0.15 .....  
**\$89.00 EA** ⚠



**5592945 .....37-51**  
Without vacuum pump 3.901 -0.15 .....  
**\$75.25 EA** ⚠

## Fuel Pump Rebuild Kits, cont.



**5591825 .....52-57**  
W/ vacuum pump 3.900 -0 ..... **\$77.25 EA** ⚠



**5592988 .....52-57**  
Without vacuum pump 3.901 -0.15 .....  
**\$64.75 EA** ⚠

## Air Filter Element

Note: Air Filter Decals see Section 550C.



**1528726.....37-48**  
Complete. 7" O.D. 3.410 -0.15 .....  
**\$41.25 EA** ⚠



**1528726A ....37-48**  
Copper mesh only 3.410 -0.15 .....  
**\$18.75 EA** ⚠



**1528698.....49-54**  
Complete. 8" OD. 6.25" ID. 1.5" Tall. 3.410 -0.15 .....  
**\$41.25 EA** ⚠



**1528698A ....49-54**  
Copper mesh only 3.410 -0.15 .....  
**\$20.50 EA** ⚠

## Carburetors

All Carburetors are rebuilt units. Base gaskets included.

Core returns must be same style as purchased unit.



**838938 ....37-40**  
Carter W-1 (\$150 core) 3.725 -0.15 .....  
**\$295.00 EA** ⚠

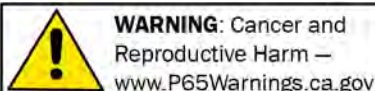

Chemicals shipped domestic ground only (Lower 48 states only). No international shipping.

Phone: (360) 816-0211 • (800) 999-CHEV (2438) • www.chevsofthe40s.com

120C



# Section 120C: Fuel System, Gas Tanks, Gas Tank Sending Units, Fuel Pumps, Carburetors, Air Cleaners & Intake Manifolds

## Carburetors, cont.



**839987** .....41-48  
Carter W-1 (\$150 core) 3.725 -0.15  
..... **\$295.00 EA** ⚠



**3692429C**..... 49  
Carter W-1 (\$150 core). 3.725 -0.15  
..... **\$295.00 EA** ⚠



**7004600** ....49-53  
Rochester. Fits 216ci (\$150 core) 3.725 -0.15  
..... **\$295.00 EA** ⚠



**7004468** ....50-51  
Rochester. Fits 235ci (\$150 core). 3.725 -0.15  
..... **\$295.00 EA** ⚠



**7007181** ....52-56  
Rochester. Fits 235ci w/ automatic choke (\$150 core) 3.725 -0.15  
..... **\$295.00 EA** ⚠



**838939** .....ALL  
New universal carb. Fits 216,235,261ci engines. -0.15  
..... **\$359.50 EA** ⚠

## Carburetor Rebuild Service

**CARBREBUILD**.....ALL  
Send in your carburetor to have rebuilt. Carter W-1, YF and Rochester model B single barrels. 3.725 -0.15 .. **\$295.00 EA** ⚠

## Matched Rebuilt Carbs

**MATCHEDCARBS**.....ALL  
Matched rebuilt carburetors for when ordering for a multi carb setup (\$150 core per carb) 3.725 -0.15 .. **\$295.00 EA** ⚠

## Carburetor Rebuild Kits



**7004363** .....32-62  
Rochester, fits 1 barrel models B, BC, BV 3.725 -0.15 ..... **\$48.50 EA** ⚠



**603978**.....36-40  
Fits Carter W-1, 216ci engine 3.725 -0.15  
..... **\$68.25 EA** ⚠



**3902169C** .....37-56  
Fits Carter Y-F, 216ci 3.725 -0.15 ..... **\$54.75 EA** ⚠

**609993** .....41-48  
Carter W-1 (216ci) 3.725 -0.15 ..... **\$64.00 EA** ⚠

**3692429**..... 49  
Carter W-1 3.725 -0.15 ..... **\$59.25 EA** ⚠

## Carburetor Insulator



**3692797**.....34-53  
Bakelite exc 50-53 235ci. 2-11/16". 3.726 -0.15 ..... **\$10.00 EA** ⚠

**3692799** .....50-59  
Bakelite (235ci). 2-15/16". 3.726 -0.2 .. **\$11.75 EA** ⚠

## Carburetor Base Gasket



**601348**.....34-49  
Carter W-1 base gasket 2-11/16 inch bolt centers. 3.726 -0.2

**\$3.50 EA** ⚠



**839632**.....50-53  
216ci engine. 2-11/16 inch bolt centers. 3.726 -0.15 ..... **\$5.00 EA** ⚠



**3712549**.....50-62  
Carburetor base (235ci, 261ci engine). 3inch bolt centers. 3.726 -0.2 ..... **\$4.75 EA** ⚠

## Carburetor Parts



**839509A** .....33-49  
Oversized throttle shaft for W-1 carburetor only 3.752 -0.15 ..... **\$42.25 EA** ⚠

**839987A** .....36-49  
W1 Carter Accelerator Pump Spring 3.725 -0 ..... **\$0.50 EA** ⚠

**839987B** .....36-49  
Idle Mixture Screw Spring 3.725 -0 ..... **\$0.50 EA** ⚠

**839987C** .....36-49  
Carter W-1 Mixture Screw 3.725 -0 ..... **\$1.00 EA** ⚠



**836636**.....37-49  
Carburetor float Carter W-1 3.725 -0.15 ..... **\$49.25 EA** ⚠

**7002672**.....37-57  
Carburetor float Rochester 3.745 -0.15 ..... **\$25.00 EA** ⚠



**7002082A** .....49-60  
Oversized throttle shaft for Rochester carburetor only 3.752 -0.15 .. **\$42.25 EA** ⚠

# Section 120C: Fuel System, Gas Tanks, Gas Tank Sending Units, Fuel Pumps, Carburetors, Air Cleaners & Intake Manifolds

## Carburetor Cleaner



**6505259 . . . . .ALL**  
Gumout, 16 oz spray can. Cleans carburetors, linkage, choke valves and unpainted metal parts. 3.725 -0.15

..... **\$6.50 EA** ⚠️

## Throttle Return Spring



**3650230 . . . . .37-40**

Throttle return spring 3.459 -0.15

**\$5.25 EA** ⚠️



**838420 . . . . .37-47**

Throttle lever stud mounted to left side of engine block 3.582 -0.15

**\$32.50 EA** ⚠️



**3659431 . . . . .41-49**

Throttle return spring 3.459 -0.15

**\$7.75 EA** ⚠️



**3695705 . . . . .50-52**

Throttle return spring 3.459 -0.15

**\$4.00 EA** ⚠️

## Air Cleaner Wing Nut



**120240 . . . . .37-54**

Air filter wing nut 8.920 -0.4

**\$1.50 EA** ⚠️

## Main Fuel Line

Oversize shipping charges apply. Please call for rate.



product varies by vehicle

**348751 . . . . .37-54**

Steel Pre-bent (specify year when ordering) 8.964 -0

..... starting at **\$69.00 SET** ⚠️

**348751S . . . . .37-54**

Stainless Pre-bent (specify year when ordering) 8.964 -0

..... starting at **\$99.00 EA** ⚠️

## Fuel Pump to Carb Fuel Line



**348750 . . . . .37-54**

Pre bent Steel (specify year when ordering) 8.964 -0

..... starting at **\$20.00 EA** ⚠️



**348750S . . . . .37-54**

Pre bent Stainless (specify year when ordering) 8.964 -0

..... starting at **\$25.00 EA** ⚠️

## Choke Tube



**348750C . . . . .50-54**

Carb to manifold, steel. Pre-bent (specify year when ordering) 8.964 -0

..... starting at **\$14.00 EA**



**348750CS . . . . .50-54**

Carb to manifold, stainless. Pre-bent (specify year when ordering) 8.964 -0

..... starting at **\$24.00 EA** ⚠️

## Vacuum Advance Line



**217276 . . . . .37-54**

Carb to distributor, steel. Pre-bent (specify year when ordering) 8.964 -0

..... starting at **\$20.00 EA** ⚠️



**217276S . . . . .37-54**

Carb to distributor, stainless. Pre-bent (specify year when ordering) 8.964 -0

..... starting at **\$25.00 EA** ⚠️

## Clip



**148129A . . . . .ALL**

Double ended, holds 1/4in. brake & 5/16 in. gas line to frame (snaps into hole). 8.950 -0.4

**\$5.75 EA** ⚠️



**3735074C . . . . .ALL**

3/8 in. slot, gas, brake line, wire harness (4 pcs). 8.950 -0.15

..... **\$8.25 SET** ⚠️



**599119 . . . . .ALL**

Holds gas & vacuum lines together, fuel pump to carburetor

(uses 4) 8.950 -0.4

..... **\$10.75 PR** ⚠️

## Manifold Gasket



**602483A . . . . .37-53**

Intake & exhaust manifold. Fits 216ci

(3pcs) 3.270 -0.15

**\$22.75 SET** ⚠️

## Manifold Gasket, cont.



**838290 . . . . .37-53**

Rectangle between manifolds. Fits 216ci

3.272 -0.15

**\$7.00 EA** ⚠️



**3707045 . . . . .50-62**

Intake & exhaust manifold. Fits 235ci & 261ci (3pcs) 3.270 -0.15

**\$21.50 SET** ⚠️



**3835572 . . . . .50-62**

Rectangle between manifolds. Fits 235ci & 261ci 3.272 -0.15

..... **\$7.75 EA** ⚠️

## Manifold Clamps & Bolts



**838546B . . . . .37-57**

Intake - Exhaust manifold clamps (spreaders). Cast reproduction. 3.273 -0.15

..... **\$55.25 SET** ⚠️



**838546BK . . . . .37-57**

Intake - Exhaust manifold bolt kit

3.273 -0.3

**\$5.00 SET** ⚠️



**838546U . . . . .37-57**

Intake - Exhaust manifold clamps (spreaders). used

3.273 -0

**\$50.00 SET** ⚠️

## Intake Metal Sleeves



**837273 . . . . .34-53**

Intake to head 216ci. Exc 50-53 235ci (3 piece set) 3.281 -0.15

..... **\$7.50 SET** ⚠️

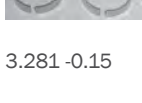

**3835506 . . . . .50-62**

Intake to head 235ci, 261ci (3 piece set)

3.281 -0.15

**\$7.50 SET** ⚠️

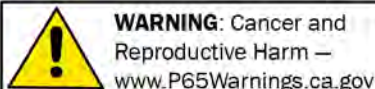

**WARNING: Cancer and Reproductive Harm** —  
www.P65Warnings.ca.gov

Chemicals shipped domestic ground only (Lower 48 states only). No international shipping.

Phone: (360) 816-0211 • (800) 999-CHEV (2438) • www.chevsofthe40s.com



# Section 120C: Fuel System, Gas Tanks, Gas Tank Sending Units, Fuel Pumps, Carburetors, Air Cleaners & Intake Manifolds

## Odds & Ends

Please call for availability on all Odds & Ends parts. Once part is sold, it may no longer be in stock.

- 593306**.....**34-58**  
Gas Lines NORS 7in. long 8.964-0.4 .....  
**\$15.00 EA** ⚠
- 1528726N**.....**37-48**  
Air filter element 3.410-0.4 . **\$75.00 EA** ⚠
- 986249**.....**41-48**  
Fil-guard (NOS Accessory) Warns 3.010-0.4 .....  
**\$75.00 EA** ⚠
- 3664885U**.....**42-48**  
Splash guard retainer used (left side only). 3.028-0 ..... **\$12.00 EA** ⚠
- 3664886U**.....**42-48**  
Splash guard retainer used (right side only) 3.028-0 ..... **\$12.00 EA** ⚠
- 05160**.....**49**  
Carburetor, Carter We w/ Auto Choke 3.724-0.4 ..... **\$300.00 EA** ⚠
- 7002890**.....**50-51**  
Carb Float Bowl, 235ci Rochester (NOS) 3.724-0.4 ..... **\$25.00 EA** ⚠
- 05280**.....**50-53**  
Carburetor, Carter Y-F. For 216ci engine 3.725-0.4 ..... **\$300.00 EA** ⚠
- 986552N**.....**51-52**  
Gas Door Guard Stainless (NOS) 12.944-0.4 ..... **\$40.00 EA** ⚠
- 5592876**.....**52**  
Diaphragm rebuild kit (NORS). Use w/ part #559226 11.000-0.4 . **\$15.00 EA** ⚠

## Odds & Ends, cont.

- 5592877**.....**52-55**  
Diaphragm rebuild kit (NORS). Use w/ part #5592627 11.000-0.4 .....  
**\$15.00 EA** ⚠
- 5592922**.....**52-55**  
Diaphragm rebuild kit (NORS). Use w/ part #5592765 3.725-0.4 . **\$15.00 EA** ⚠
- 987621**.....**53-55**  
Gas cap locking w/ flip door. Nice condition (Used) 3.028-0 .. **\$25.00 EA** ⚠
- 985027**.....**60**  
Stainless steel fuel guard NOS (fits station wagon) 12.944-0.4 ..... **\$40.00 EA** ⚠
- 985206**.....**60**  
Stainless steel fuel guard NOS (fits all passenger except station wagon) 12.944-0.4 ..... **\$40.00 EA** ⚠
- 985119**.....**62**  
Stainless steel fuel guard NOS (fits all passenger except station wagon) 12.944-0.4 ..... **\$40.00 EA** ⚠
- 985489**.....**63**  
Stainless steel fuel guard NOS (fits station wagon) 12.944-0.4 ..... **\$40.00 EA** ⚠
- 985885**.....**63**  
Stainless steel fuel guard NOS (fits all passenger except station wagon) 12.944-0.4 ..... **\$40.00 EA** ⚠

ILLUSTRATIONS ARE COMPLETE ASSEMBLIES

SEE TEXT FOR AVAILABILITY

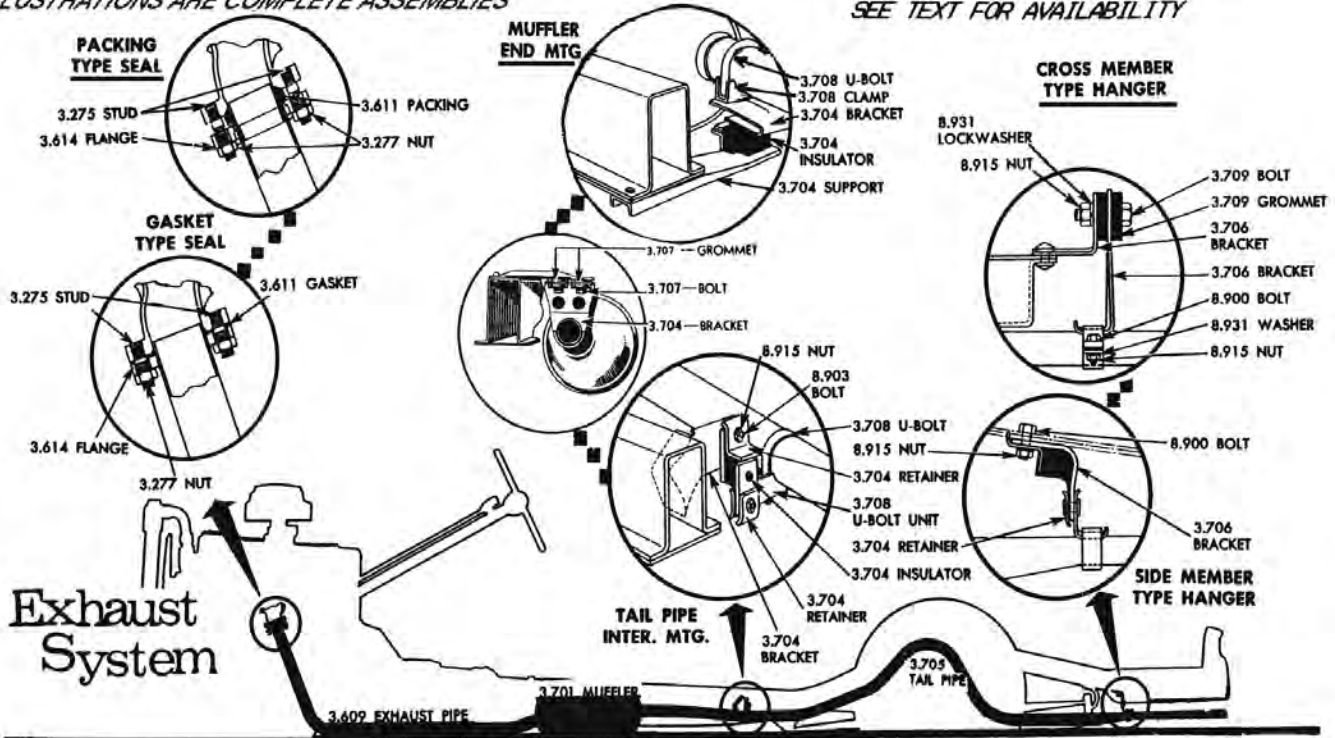

Returns require a return authorization number—call first. • Product pricing & availability subject to change.

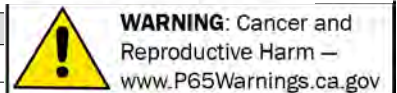

**SECTION 130C  
STREET ROD PARTS**

**Dual Exhaust System**

Nothing can beat the sound of the "Split Six" Dual Exhaust! This complete dual exhaust system has been designed for the do-it-yourselfer, and can be installed right in your own backyard or garage. All exhaust pipes are pre-bent, to fit and are made of aluminized tubing for long lasting life. William's Exhaust Headers will improve performance, and glass packed mufflers will give your car the sound made famous in the 50's. Complete with all necessary hardware and installation instructions, (Clamps, hangers, donuts, etc.)

- 2018DUAL** ..... **41-48**  
Standard Transmission Exc. Conv. -0.15  
..... **\$693.50 EA** ⚠
- 2019DUAL** ..... **49-52**  
Standard Transmission Exc. Conv. -0.15  
..... **\$727.50 EA** ⚠
- 2020DUAL** ..... **50-52**  
Automatic Exc. Conv. -0.15  
..... **\$693.50 EA** ⚠
- 2021DUAL** ..... **53-54**  
Standard Transmission Exc. Conv. -0.15  
..... **\$693.50 EA** ⚠
- 2022DUAL** ..... **53-54**  
Exhaust System- Complete Aluminized  
Dual System (Automatic) Exc. Conv. -0.15  
..... **\$693.50 EA** ⚠

**Fenton Headers**



- 3657963A** ..... **37-62**  
Fenton headers. Cast iron, for all 1937-62  
216ci, 235ci & 261ci engines. Comes with  
header flange and gaskets.  
3.609-0.2 ..... **\$199.00 PR** ⚠
- 3657963G** ..... **37-62**  
Fenton headers. Cast iron, for all GMC  
228ci, 248ci, 270ci & 302ci engines.  
Comes with header flange and gaskets.  
3.609-0 ..... **\$199.00 PR** ⚠

**Fenton Heat Kit**



- 838574B** ..... **37-53**  
Heat kit. Split headers to intake. 216ci  
only. 3.640-0.2 ..... **\$44.25 EA** ⚠
- 838573B** ..... **50-62**  
Heat kit. Split headers  
to intake. 235ci only.  
3.640-0.2 .....  
**\$44.25 EA** ⚠

**Manifold Clamps & Bolts**

- 3657963S** ..... **37-62**  
Bolt set for Fenton headers. 3.609-0.3  
..... **\$6.75 SET** ⚠

**Tube Headers**



- 3657963SS** ..... **37-62**  
Polished stainless finish. Includes weld-on  
header pipe flanges. Fits 216ci or 235ci.  
3.609-0.15 ..... **\$225.00 SET** ⚠



- 3657963T** ..... **37-62**  
Black painted finish. Includes weld-on  
header pipe flanges. Fits 1937-62 216ci,  
235ci & 261ci. 3.609-0.2 ..... **\$125.00 PR**  
⚠

**SECTION 130C  
RESTORATION PARTS**

**Manifold Clamps & Bolts**



- 838546B** ..... **37-57**  
Intake - Exhaust manifold clamps  
(spreaders). Cast reproduction. 3.273-0.15  
..... **\$55.25 SET** ⚠

**Manifold Clamps & Bolts, cont.**



- 838546U** ..... **37-57**  
Intake - Exhaust  
manifold clamps  
(spreaders). used  
3.273-0 .....

**\$50.00 SET** ⚠

**Exhaust System**

Note: Complete system includes header pipe gasket, studs & nuts, header pipe spring (1938-42). Header pipe, muffler, muffler clamps & muffler grommet/ insulator (1937-50). Tailpipe, intermediate insulator & clamp (1951-54 except convertible) and tailpipe H unit. All pipes are aluminized.  
Oversize shipping charges apply to all Exhaust Systems. Please call for rate.



- 594131B** ..... **37-38**  
All cars 3.609-0.15 ... **\$300.00 EA** ⚠
- 350505B** ..... **39**  
All cars 3.609-0.15 ... **\$300.00 EA** ⚠
- 3653386B** ..... **40**  
Except Cabriolet 3.609-0.15 .....
- \$300.00 EA** ⚠
- 3655245B** ..... **40**  
Cabriolet 3.609-0.15 . **\$300.00 EA** ⚠
- 3657963B** ..... **41-48**  
Except Cabriolet 3.609-0 ..... **\$300.00 EA**  
⚠
- 3659737B** ..... **41-48**  
Cabriolet 3.609-0 ... **\$300.00 EA** ⚠
- 3690587B** ..... **49-50**  
Stick exc Convertible 3.609-0.15 .....
- \$300.00 EA** ⚠
- 3690589B** ..... **49-50**  
Stick Convertible 3.609-0.15 .....
- \$300.00 EA** ⚠
- 3693548B** ..... **50**  
W/ Powerglide exc Convertible 3.609-0.15  
..... **\$300.00 EA** ⚠
- 3693598B** ..... **50**  
W/ Powerglide, Convertible 3.609-0.15  
..... **\$300.00 EA** ⚠
- 3697054B** ..... **51-52**  
Convertible, stick 3.609-0.15 .....
- \$300.00 EA** ⚠
- 3697601B** ..... **51-52**  
W/ Powerglide, Convertible 3.609-0.15  
..... **\$300.00 EA** ⚠
- 3697602B** ..... **51-52**  
Powerglide-exc Convertible, 52 Wagon  
3.609-0.15 ..... **\$300.00 EA** ⚠
- 3700499B** ..... **51-52**  
Stick exc Convertible 3.609-0 .....
- \$300.00 EA** ⚠
- 3697963B** ..... **53**  
Exc Convertible, Wagon, Sedan Delivery  
3.609-0 ..... **\$300.00 EA** ⚠

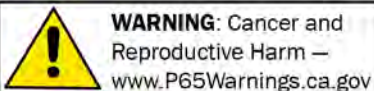

Chemicals shipped domestic ground only (Lower 48 states only). No international shipping.

**Phone: (360) 816-0211 • (800) 999-CHEV (2438) • www.chevsofthe40s.com**



**Exhaust System, cont.**

- 3701620B** ..... **53**
- Wagon 3.609 -0.15 ..... **\$275.00 EA** ⚠
- 3704564B** ..... **53**
- Sedan Delivery 3.609 -0.15 .....
- \$300.00 EA** ⚠
- 3697976B** ..... **53-54**
- Convertible 3.609 -0 ..... **CALL** ⚠
- 3704898B** ..... **54**
- Exc Convertible & Wagon 3.609 -0 .....
- \$300.00 EA** ⚠
- 3704999B** ..... **54**
- Wagon 3.609 -0 ..... **\$300.00 EA** ⚠

**Header Pipe**

- 594131** ..... **37-38**
- All cars 3.609 -0.15 ..... **\$90.25 EA** ⚠
- 350505** ..... **39**
- All Cars 3.609 -0.15 ..... **\$73.75 EA** ⚠
- 3653386** ..... **40**
- All Cars 3.609 -0.15 ..... **\$99.00 EA** ⚠



- 3657963** ..... **41-48**
- Except Cabriolet 3.609 -0.15 .....
- \$123.00 EA** ⚠
- 3659737** ..... **41-48**
- Cabriolet 3.609 -0.15 ..... **\$150.00 EA** ⚠
- 3690589** ..... **49-50**
- Stick Convertible 3.609 -0.15 .....
- \$90.25 EA** ⚠
- 3700499** ..... **49-52**
- Stick exc Convertible 3.609 -0.15 .....
- \$99.00 EA** ⚠



- 3693548** ..... **50**
- W/ Powerglide exc Convertible 3.609 -0.15 .....
- \$90.25 EA** ⚠
- 3693598** ..... **50**
- W/ Powerglide, Convertible 3.609 -0.15 .....
- \$90.00 EA** ⚠
- 3697054** ..... **51-52**
- Stick, Convertible 3.609 -0.15 .....
- \$90.00 EA** ⚠
- 3697058** ..... **51-54**
- Convertible exc 51-52 Convertible stick 3.609 -0.15 .....
- \$90.00 EA** ⚠
- 3701055** ..... **51-54**
- Exc Convertible, 53 Sedan Delivery & 51-52 stick 3.609 -0.15 ..
- \$131.25 EA** ⚠
- 3704564** ..... **53**
- Sedan Delivery 3.609 -0.15 ..... **\$99.00 EA** ⚠

**Muffler**

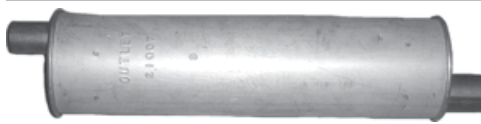

- 593172** ..... **37-39**
- 17" length, 6-1/2" dia. 3.701 -0 ..... .....
- \$90.00 EA** ⚠
- 3653658** ..... **40**
- Except 40 Cabriolet 3.701 -0.15 .....
- \$90.00 EA** ⚠
- 3659201** ..... **41-48**
- Exc. Cabriolet 3.701 -0.15 ..... **\$90.00 EA** ⚠
- 3659202** ..... **41-48**
- Cabriolet 3.701 -0.15 ..... **\$90.00 EA** ⚠
- 3698039** ..... **49-52**
- Stick shift, Convertible. 12" length, 7-1/2" dia. 3.701 -0.15 .....
- \$100.00 EA** ⚠



- 3698042** ..... **50-52**
- w/ Powerglide, Convertible 3.701 -0.15 .....
- \$50.00 EA** ⚠
- 3698714** ..... **53-54**
- Convertible 3.708 -0.15 ..... **\$90.00 EA** ⚠
- 3704991** ..... **54**
- Except Convertible 3.701 -0.15 .....
- \$126.25 EA** ⚠

**Tailpipe**

Oversize shipping charges apply. Please call for rate.

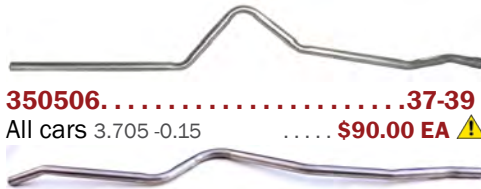

- 350506** ..... **37-39**
- All cars 3.705 -0.15 ..... **\$90.00 EA** ⚠
- 3653725** ..... **40**
- Exc Cabriolet 3.705 -0.15 ..... **\$100.00 EA** ⚠
- 3655245** ..... **40**
- Cabriolet 3.705 -0.15 ..... **\$90.00 EA** ⚠
- 3681291** ..... **41-48**
- Exc Cabriolet 3.705 -0.15 ..... **\$144.00 EA** ⚠
- 3682046** ..... **41-48**
- Cabriolet 3.705 -0.15 ..... **\$160.00 EA** ⚠
- 3697601** ..... **49-52**
- Convertible 3.705 -0.15 ..... **\$98.50 EA** ⚠

**Tailpipe, cont.**



- 3698043** ..... **49-52**
- Exc Powerglide & Convertible. 3.705 -0.15 .....
- \$126.50 EA** ⚠
- 3697602** ..... **50-52**
- Powerglide exc Convertible, 52 Wagon. 3.705 -0.15 .....
- \$99.00 EA** ⚠
- 3697963** ..... **53**
- Exc Convertible, Wagon. 3.705 -0.15 ..
- \$144.00 EA** ⚠
- 3697976** ..... **53-54**
- Convertible 3.705 -0 ..... **CALL** ⚠
- 3704898** ..... **54**
- Exc Convertible, Wagon. 3.705 -0.15 ..
- \$82.00 EA** ⚠
- 3704999** ..... **54**
- Wagon 3.705 -0.15 ..... **\$90.00 EA** ⚠

**Gasket-Manifold**

- 602483A** ..... **37-53**
- Intake & exhaust manifold. Fits 216ci .....
- \$22.75 SET** ⚠
- (3pcs) 3.270 -0.15
- 838290** ..... **37-53**
- Rectangle between manifolds. Fits 216ci 3.272 -0.15 .....
- \$7.00 EA** ⚠



- 3707045** ..... **50-62**
- Intake & exhaust manifold. Fits 235ci & 261ci (3pcs) 3.270 -0.15 .. **\$21.50 SET** ⚠
- 3835572** ..... **50-62**
- Rectangle between manifolds. Fits 235ci & 261ci 3.272 -0.15 ..
- \$7.75 EA** ⚠



**Heat Riser Spring**

- 602799** ..... **37-54**
- Anti-rattle spring 3.653 -0.4 ..... **\$7.00 EA** ⚠
- 838573** ..... **37-54**
- Thermostatic spring. Allows flap to open and close with temperature. 3.653 -0.2 .....
- \$18.00 EA** ⚠



Returns require a return authorization number—call first. • Product pricing & availability subject to change.

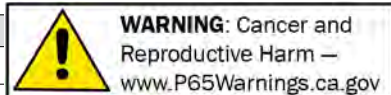

**Heat Riser Shaft**

**596264A.....37-54**  
Oversize requires reaming worn manifold holes 3.650-0  
..... **CALL** ⚠

**Studs In Manifold**



**837552B.....29-54**  
For header pipe, 3/8 in. x 2 in. w/ brass hex nuts 3.275-0.15  
..... **\$3.25 SET** ⚠

**Flange Plate**



**593607.....37-53**  
Holds header pipe to manifold, 216ci 3.610-0.15  
..... **\$17.50 EA** ⚠

**3696988F.....37-62**  
For Fenton Headers 3.610-0.15  
..... **\$5.50 EA** ⚠



**3696988.....51-57**  
235ci 3.610-0.15  
..... **\$11.00 EA** ⚠

**Gasket**



**3696990.....34-54**  
Header pipe to manifold, 34-36 all, 51-52 w/ Powerglide, 53-54 exc 53 Sedan Delivery 3.611-0.15  
..... **\$5.50 EA** ⚠



**593606.....37-53**  
Header pipe to manifold, 37-48, 51-52 stick shift & 53 Sedan Delivery 3.611-0  
..... **\$4.00 EA** ⚠

**\$4.00 EA** ⚠



**3692831.....49-50**  
Header pipe to manifold, also fits Fenton headers 3.611-0.15  
..... **\$3.50 EA** ⚠

**\$3.50 EA** ⚠

**Spring**



**369511.....32-48**  
Support rear of header pipe, stainless steel 3.616-0.4  
..... **\$6.00 EA**

**Muffler Clamp**



**3693811.....37-52**  
Front, exc Powerglide, 1-7/8in. 3.708-0.15  
..... **\$2.75 EA** ⚠

**3693812.....37-52**  
Rear, stick, 1-5/8 in. 3.708-0.15  
..... **\$5.50 EA** ⚠

**3693812.....50-52**  
Rear, Convertible, 1-5/8 in. 3.708-0.15  
..... **\$5.50 EA** ⚠

**Muffler Clamp, cont.**

**3718800.....50-52**  
Rear, Powerglide exc Convert, 1-3/4in. 3.708-0.15  
..... **\$2.00 EA** ⚠

**3694837.....50-54**

Front, 2 in. 3.708-0.15  
..... **\$5.25 EA** ⚠

**3718800.....53-54**

Rear, 1-3/4in. 3.708-0.15  
..... **\$2.00 EA** ⚠

**Muffler Insulator**



**593638.....37-40**  
Muffler Insulator Grommet, rear hanger. Uses 2 3.707-0.4  
..... **\$6.50 EA** ⚠



**3661831.....41-50**  
Rear hanger 3.704-0  
..... **CALL** ⚠

**Tailpipe Hanger Grommet**



**593638.....37-50**  
Tailpipe Hanger Grommet, rear. 3.707-0.4  
..... **\$6.50 EA** ⚠

**Tailpipe Hanger**



**3652715.....37-40**  
W/ grommet. 3.706-0  
..... **CALL** ⚠



**3696881A.....37-54**  
W/ clamp replacement (2 pcs). 3.706-0  
..... **\$16.50 EA** ⚠



**3658199.....41-48**  
Includes grommet. Fits 41-42 & 48 3.706-0.3  
..... **\$34.00 EA** ⚠



**3681293.....46**  
Oval pipe, w/ grommet. 3.706-0.2  
..... **\$14.75 EA** ⚠



**3685789.....47**  
Oval pipe, w/ grommet. 3.706-0.2  
..... **\$26.25 EA** ⚠



**3693035.....50**  
Powerglide exc Convertible. With grommet 3.706-0.4  
..... **\$25.00 EA** ⚠



**3697071.....51-52**  
Intermediate, stick shift (exc. Convertible), 1-5/8in. Use w/ #3697060. 3.708-0  
..... **\$15.00 EA** ⚠

**Tailpipe Hanger, cont.**



**3696885A.....51-54**  
Rubber only. 3.706-0.15  
..... **\$86.75 EA** ⚠

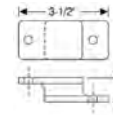

**3697060.....51-54**  
Hanger insulator. Intermediate. 3.704-0  
..... **\$52.75 EA** ⚠



**3710288.....51-54**  
Intermediate, exc 51-52 stick & all convert, 1-3/4in. (use w/ insulator #3697060). 3.708-0.3  
..... **\$52.50 EA** ⚠

**Exhaust Extension**



**985707.....41**  
Exhaust Extension Whale Tail shaped. Left side. Superb stainless reproduction of original accessory. 3.705-0  
..... **CALL** ⚠

..... **CALL** ⚠



**985808.....41**  
Exhaust Extension Right Side Whale Tail shaped, with clamp. Superb chrome reproduction of original accessory. 3.705-0  
..... **CALL** ⚠

..... **CALL** ⚠



**985848.....42-48**  
Bearclaw shape. Superb chrome reproduction of original. 3.705-0  
..... **\$125.00 EA** ⚠



**51A18529P.....ALL**  
Plain, Polished Stainless. -0.15  
..... **\$20.00 EA** ⚠



**594135.....ALL**  
Clamp, original for tailpipe extension w/ nut & bolt. 3.708-0.15  
..... **\$6.75 EA** ⚠



**985992A.....ALL**  
Era accessory polished stainless steel w/ stamped bowtie. 3.705-0.15  
.....

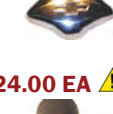

..... **\$24.00 EA** ⚠



**985992C.....ALL**  
CHROME Bowtie shaped outlet. 2-1/4" I.D. (not pre-drilled). 3.705-0.15  
.....



..... **\$35.00 EA** ⚠

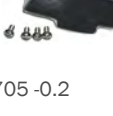

**986885S.....ALL**  
Show Chromed 409 STAINLESS STEEL Bowtie shape. 2-1/4" I.D. (not pre-drilled). 3.705-0.2  
..... **\$58.25 EA** ⚠

..... **\$58.25 EA** ⚠

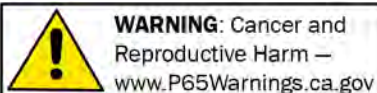

**WARNING: Cancer and Reproductive Harm** — www.P65Warnings.ca.gov

Chemicals shipped domestic ground only (Lower 48 states only). No international shipping.

**Phone: (360) 816-0211 • (800) 999-CHEV (2438) • www.chevsofthe40s.com**



**Exhaust Paint**



**3657963C .....ALL**  
 Exhaust paint stainless steel pigments. For exhaust manifolds & pipes. Gives a soft grey, metallic finish. Pint 3.609 -0 **CALL** ⚠

3.609 -0



**3657963D .....ALL**  
 Cast blast paint high temp 1200 degree. Grey, fresh cast look for exhaust manifolds, etc.

Rust preventative, 11 oz spray can.

3.609 -0.15

..... **\$18.00 EA** ⚠



**3657963E.....ALL**  
 Exhaust paint clear, high temp (1200 degree) for exhaust etc, 11 oz spray can.

3.609 -0.15

..... **\$21.25 EA** ⚠



**3657963FA.....ALL**  
 Exhaust paint very high temp, flat aluminum for manifolds & pipes. 11 oz spray can. 3.609 -0

..... **\$19.00 EA** ⚠

**Odds & Ends**

Please call for availability on all Odds & Ends parts. Once part is sold, it may no longer be in stock.

**6023664U .....37-39**

Exhaust manifold. Casting #838397

(Used) 3.601 -0.4 ..... **\$125.00 EA** ⚠

**3694163 .....50-57**

Intake manifold. Fits all exc 216ci & DD

(Used) 3.609 -0.4 ..... **\$65.00 EA** ⚠

**986885N .....53-54**

Accy. Exhaust Extension, Stainless

3.705 -0.4 ..... **\$100.00 EA** ⚠

**987116.....55-57**

Exhaust chrome extension w/ chevrolet emblem (NOS) 3.705 -0.4

..... **\$100.00 EA** ⚠

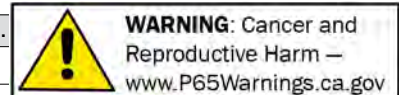







**SECTION 140C  
RESTORATION PARTS**

**Pilot Bearing**



**907109 .....31-39**

This roller style pilot bearing fits into the end of the engine crankshaft and

supports the input shaft of the transmission. 0.649-0.15 .. **\$18.50 EA**



**Pilot Bushing**



**412562 .....39-66**

This bushing style pilot bearing fits into the end of the engine crankshaft

and supports the input shaft of the transmission.

0.649-0.2 ..... **\$12.50 EA** ⚠

**Throwout Arm Ball**



**2054961C .....32-37**

2 pieces w/o clips or lockwasher. 0.796-0

..... **CALL** ⚠

**2054961 .....38-54**

Stud, 1-1/2in. long. 0.796-0.4

..... **\$6.00 EA** ⚠

**Throwout Arm**



**609952 .....38-39**

Fits passenger. 0.795-0 ... **CALL** ⚠

**Clip**



**838987 .....31-54**

Throwout arm to ball stud. 0.823-0.15

..... **\$6.00 EA** ⚠

**Throwout Bearing**



**909422 .....38-54**

0.799-0.2

..... **\$34.25 EA** ⚠

**Throwout Arm Spring**



**3653114 .....40-54**

17.5" , exc 41-48 Cabriolet. 0.844-0.15

..... **\$10.00 EA** ⚠

**Throwout Arm Spring, cont.**

**3659731 ..... 41-48**

11in. , Cabriolet. 0.844-0.15

..... **\$10.00 EA** ⚠

**Complete Clutch Kit**



**838956B .....38-53**

Replacement 9in. clutch and pressure plate kit. Includes pilot bushing, throwout bearing, alignment tool and lube. 0.863-0

..... **CALL** ⚠

**Pressure Plate**

**838949 ..... 38-53**

Rebuilt Heavy duty, 10-3/4in. (\$150

core). 0.863-0.15 ..... **\$179.75 EA** ⚠



**838956 .....38-53**

Rebuilt 9in. (\$50 core). 0.863-0.15

..... **\$125.00 EA** ⚠

**3836715 ..... 54-57**

Rebuilt Use w/ 9in. & 10in. disc (\$50

core). 0.863-0.15 ..... **\$153.75 EA** ⚠

**Clutch Disc**

**3835483 ..... 38-53**

Rebuilt 10-3/4in. o.d. (\$100 core).

0.886-0.15 ..... **\$159.75 EA** ⚠

**3835483N ..... 38-53**

New 10-1/2" No Core 0.886-0

..... **\$141.00 EA** ⚠



**3847450 .....38-54**

Rebuilt 9in. o.d. (\$40 core). 0.886-0.15

..... **\$98.00 EA** ⚠

**3847450N .....38-54**

New 9" clutch disk. 0.886-0

..... **\$125.25 EA** ⚠

**3836119 ..... 54-57**

Rebuilt 10in. (\$40 core). 0.886-0.15

..... **\$113.50 EA** ⚠

**3836119N ..... 54-57**

10in. (\$40 core). 0.886-0 ..... **\$114.75 EA**



**Pressure Plate Spring**



**838646 .....38-53**

Clutch Pressure Plate Spring 0.863-0.2

..... **\$8.00 EA** ⚠

**Pressure Plate & Flywheel Bolts**



**838653 .....38-57**

Pressure plate bolts. Shouldered 3/8-16, 1" length, grade 8.

Includes lock washers.

Set of 6. Restoration only for Chevy I-6cyl.

0.863-0.15 ..... **\$23.75 SET** ⚠



**839756 .....38-57**

Mounts flywheel to crank. 7/16-20, 31/32", grade 8.

Includes lock washers.

Set of 6. Restoration only for Chevy I-6cyl.

0.669-0.15 ..... **\$22.50 SET** ⚠

**Tool**



**838956A .....ALL**

Tool to align clutch disc. 0.866-0.3

..... **\$12.25 EA** ⚠

**Flywheel Ring Gear**

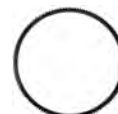

**838177 .....37-54**

139 teeth (exc powerglide). 0.667-0.2

..... **\$65.00 EA** ⚠

**Odds & Ends**

Please call for availability on all Odds & Ends parts. Once part is sold, it may no longer be in stock.

**3664495 .....31-37**

Clutch fork. Fits all exc CC, DA, DC, EA,

EC, ED, FA, FC, FD, GA, GB 0.795-0.4

..... **\$25.00 EA** ⚠

**473503 ..... 33-36**

2nd & 3rd spd clutch-commercial

4.380-0.4 ..... **\$35.00 EA** ⚠

**3835454N .....46-53**

Clutch disc. Fits 235ci. (NOS) -0.4

..... **\$75.00 EA** ⚠

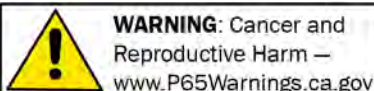

Chemicals shipped domestic ground only (Lower 48 states only). No international shipping.

**Phone: (360) 816-0211 • (800) 999-CHEV (2438) • www.chevsofthe40s.com**





**SECTION 150C  
STREET ROD PARTS**

**Line Clamp Stainless**



- 13275.....ALL**  
3/16" x 3/8" double combination (6 clamps). 8.950 -0.15 ..... **\$19.75 SET** ⚠
- 13276.....ALL**  
3/16" x 3/16" double (6 clamps). 8.950 -0.15 ..... **\$18.00 SET** ⚠
- 13284.....ALL**  
5/16" x 3/8" double combination (6 clamps). 8.950 -0.15 ..... **\$18.00 SET** ⚠

**Transmission Crossmember**

- TRANSCROSS.....39-48**  
Bolt on crossmember converts your stock auto or manual trans frame to accept all GM automatic transmissions, except Powerglide. Uses all original crossmember mounting holes. Chevy car 39-48 -0.15 ..... **\$265.50 EA** ⚠

**SECTION 150C  
RESTORATION PARTS**

Note: Floorshift seals & boots see Section 320C.

Note: For die cut pad & gasket for floor insert over transmission see Section 320C.

**Trans Cooler Lines**

Oversize shipping charges apply. Please call for rate.

- 348750T.....50-54**  
Steel, Pre-bent. Powerglide (specify year when ordering). 8.964 -0 .....starting at **\$45.00 SET** ⚠
- 348750TS.....50-54**  
Stainless, Pre-bent. Powerglide (specify year when ordering). 8.964 -0 .....starting at **\$75.00 SET** ⚠

**Shift Knob**



- 374993.....29-39**  
All floor shift, black. 4.009 -0.15 ..... **\$8.75 EA** ⚠
- 985099.....37**  
Brown, accessory. 4.009 -0.15 ..... **\$35.00 EA** ⚠
- 985240.....38**  
Ivory, accessory. 4.009 -0 ..... **CALL** ⚠
- 3650273.....39**  
Column shift, rose tan, original. 4.009 -0.15 ..... **\$9.00 EA** ⚠

**Shift Knob, cont.**



- 3665490.....40-48**  
Ivory, original. Original color and quality. 4.009 -0 ..... **\$14.00 EA**

- ⚠ **3665490E.....40-48**  
Ivory, original. Original color and quality. 4.009 -0 ..... **\$9.00 EA** ⚠



- 3686800.....49**  
Tan, original. 4.009 -0.15 ..... **\$17.00 EA** ⚠



- 3693923.....50**  
Grey, original. Original color and quality. 4.009 -0.4 ..... **\$14.00 EA** ⚠



- 3694310.....50-52**  
Ivory Powerglide, original. 4.009 -0.15 ..... **\$18.00 EA** ⚠



- 3699416.....51-52**  
Ivory, stick, original. Original color and quality. 4.009 -0.15 ..... **\$14.00 EA** ⚠



- 3718171.....53-54**  
Black (exc Powerglide). Original. Original color and quality. 4.009 -0.4 ..... **\$14.00 EA** ⚠

**Shift Indicator Dial**



- 3696730R.....50-52**  
Shift Indicator Dial Fits 50-52 Powerglide 4.038 -0 ..... **\$54.00 EA** ⚠



- 3701577R.....53-54**  
Shift Indicator Dial Fits 53-54 Powerglide 4.038 -0 ..... **\$70.00 EA** ⚠
- 3701575.....53-57**  
Shift Indicator Bezel For Powerglide and Hydramatic 4.038 -0 ..... **\$22.00 EA** ⚠

**Indicator Needle**



- 3701576.....53-54**  
Powerglide 4.038 -0.15 ..... **\$35.00 EA** ⚠

**Rubber Cap**



- 594349A.....37-38**  
On floor shift tower. 4.015 -0.15 ..... **\$64.75 EA** ⚠

**Floor Shift Seal**



- 594349.....37-38**  
Trans to floor, sponge. 4.015 -0.15 ..... **\$1.00 EA** ⚠

**Floor Shift Boot**



- 3651348A.....ALL**  
Replacement-3 speed (uses #3654365T trim ring). 4.015 -0.3 ..... **\$10.50 EA** ⚠

**Floor Shift Boot Trim Ring**



- 3654365T.....ALL**  
Stainless retains boot #3651348A. 4.044 -0.15 ..... **\$14.00 EA** ⚠

**Shift Handle Spring And Pivot Pins**



- 3654731.....40-57**  
Column shift handle (fits 40-54 car & 48-57 truck). 4.025 -0.15 ..... **\$22.50 SET** ⚠

**Shift Handle Pivot Pins**



- 3653719.....40-57**  
Column shift handle (2 pcs). 4.025 -0.15 ..... **\$2.00 PR** ⚠

**Shift Tube Support Bracket**



- 3698234.....49-54**  
Supports top of shift tube under steering wheel. 4.018 -0.15 ..... **CALL** ⚠

**Steering Column Plug**



- 598141A.....49-53**  
3/4in. for shift box base of steer column. 4.022 -0.3 ..... **\$1.50 EA** ⚠

**Shift Box Rubber Bellows**



- 3686796.....49-54**  
On shift box, base of steering column. 4.015 -0.15 ..... **\$3.50 EA** ⚠

**Shift Shaft Bushing**



- 3654491.....40-48**  
Nylon replacement. Bottom end of shaft on steering column. 4.007 -0.3 ..... **\$10.00 EA** ⚠

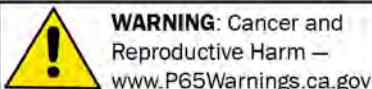

Chemicals shipped domestic ground only (Lower 48 states only). No international shipping.

Phone: (360) 816-0211 • (800) 999-CHEV (2438) • www.chevsofthe40s.com



**Shift Shaft Bushing, cont.**

**3654491B** .....40-48  
Bronze replacement. Bottom end of shaft on steering column. 4.007 -0 **\$24.00 EA** ⚠️

**3693802** .....50-54  
This is a shifter bushing for the end of shaft on steering column. It's a Bronze replacement.

\*NOTE\* need to thoroughly clean contact surface prior to installation. -0 .....  
**\$20.00 EA** ⚠️

**Shift Linkage Bushing**

**3654430** .....40-48  
Rubber shift rod ends. 2 small, 2 large.  
4.021 -0.4 ..... **\$14.00 SET** ⚠️

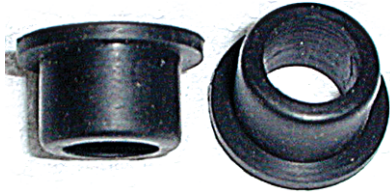

**365244** .....49-57  
Rubber bushing shift rod ends (4 pcs).  
4.016 -0.15 ..... **\$8.00 SET** ⚠️

**Shift Arm Bushing**



**3710401** .....39-57  
Grommet with metal lining. Shift arm to steering column.  
4.040 -0.15 .....

**\$5.00 EA** ⚠️

**Shift Arm Mount Cushions**



**3650270** .....39-48  
for vacuum shift unit (2 pcs). 4.046 -0.15 .....  
**\$48.00 SET** ⚠️

**Vacuum Shift Hose**



**609863** .....39-48  
Hose for vacuum shift (30in.). 4.046 -0.2 .....  
**\$7.50 KIT** ⚠️

**609863ABULK^** ..... ALL  
Hose for vacuum shift 3/8in ID sold by the inch 4.046 -0.2 ..... **\$0.25 EA** ⚠️

**Vacuum Shift Hose Clamp**



**111603** .....39-48  
Vacuum shift hose, original (uses 4) (4 piece set). 4.046 -0.15 .....  
**\$20.75 SET** ⚠️

**Vacuum Shift Cylinder Rubber Boot**



**3650360** ..... 39  
Vacuum shift cylinder.  
4.044 -0.15 .....  
**\$66.50 EA** ⚠️

**Vacuum Shift Cylinder Rubber Boot, cont.**



**3654365** .....40-48  
Vacuum shift cylinder (rectangular grommet #3652647 included).  
4.044 -0.15 .....

**\$44.50 EA** ⚠️

**Vacuum Shift Adjustment Tools**



**J14505** ..... 39  
Vacuum shift adjustment tool w/ instructions. 4.045 -0.2 .....  
**\$12.50 EA** ⚠️



**J14525** .....40-48  
Vacuum shift adjustment tool w/ instructions. 4.045 -0.4 .....  
**\$8.00 EA** ⚠️

**Gear Shift Conversion Kit**



**CHEV454** .....40-48  
This kit contains the necessary parts and instructions to replace the vacuum shift mechanism with a manual system - easily installed. Will not fit Cabriolet. Includes 3654430 to replace shift rod bushings.  
4.019 -0 ..... **\$180.00 EA** ⚠️

**Powerglide Band**



**5454570** .....50-57  
Low and reverse (\$50 core). 4.251 -0.15 .....  
**\$113.25 EA** ⚠️

**Powerglide Overhaul & Rebuild Kits**



**3701030** .....50-52  
Master overhaul kit: Gaskets, lip seals, O-rings, sealing rings, friction lined clutches, steel clutches, front pump seal for steel clutches pump seal & extension housing seal. 4.005 -0.15 .....  
**\$299.75 KIT** ⚠️

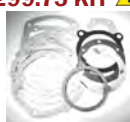

**3701030A** .....50-52  
Rebuild kit: Gaskets, lip seals, O-rings, seal rings, (short set) front pump seal & extension

housing seal. 4.005 -0.15 .....  
**\$240.00 KIT** ⚠️

**Powerglide Overhaul & Rebuild Kits**



**3703919** .....53-54  
Master overhaul kit: Gaskets, lip seals, O-rings, sealing rings, friction lined clutches, steel clutches, front pump seal for steel clutches pump seal & extension housing seal. 4.005 -0.15 .....  
**\$299.75 KIT** ⚠️



**3703919A** .....53-54  
Rebuild kit: Gaskets, lip seals, O-rings, seal rings, (short set) front pump seal & extension

housing seal. 4.005 -0.15 .....  
**\$225.25 KIT** ⚠️

**Powerglide Trans Modulator Lines**

Overize shipping charges apply. Please call for rate.

**217276T** .....50-54  
Steel Pre-bent (specify year when ordering). 8.964 -0 .....starting at **\$25.00 SET** ⚠️

**217276TS** .....50-54  
Stainless Pre-bent (specify year when ordering). 8.964 -0.15 .....starting at **\$35.00 SET** ⚠️

**Synchro Ring**



**605020A** .....40-54  
Press in, brass 4.380 -0.15 .....  
**\$25.00 EA** ⚠️

**Transmission Small Parts Kit**



**609926** .....37-54  
Thrust washers, needle bearings (3-speed). 4.004 -0.15 ... **\$57.25 KIT** ⚠️

**Transmission Bearing**



**954168.....37-54**  
Rear of trans case (tail shaft). Fits 3spd  
4.408-0.2 .....

**\$49.25 EA** ⚠



**435844.....37-57**  
Front bearing on main drive gear. (3spd)  
4.355-0.2 .....

**\$49.25 EA** ⚠

**Transmission Tailshaft Bushing**



**3717682.....49-54**  
Rear of tailshaft. 4.455-0  
..... **CALL** ⚠

**Transmission Gasket Set**



**3764394.....37-54**  
Transmission gasket set 3-speed (Except Powerglide). Includes torque tube ball seal kit 37234890 4.005-0.15  
..... **\$22.25 SET** ⚠

**Transmission Shift Fork**



**3845048.....49-55**  
2nd & 3rd gear (\$20 core). 4.303-0.15  
..... **\$35.00 EA** ⚠

**Transmission Shift Fork Seal**



**591660.....40-55**  
Inside cover, 3-speed (2 pcs). 4.107-0  
.....

**\$13.75 SET** ⚠

**Transmission Cluster Shaft**



**591213.....40-57**  
3 speed roller bearing type. Fits bushing w/ modifications. 4.428-0  
..... **CALL** ⚠

**Transmission Cluster Gear Bushing**



**591210.....37-53**  
Fits bushing-styled cluster (2 pcs). 4.422-0.2  
..... **\$18.75 SET** ⚠

**Transmission Soft Plug**



**103892.....39-48**  
End of cluster shaft & reverse idler shaft.  
8.970-0.4 .....

**\$2.50 EA** ⚠

**Transmission Mount**



**756100A.....34-51**  
Kit repairs your transmission mount.  
4.081-0 .....

**CALL** ⚠



**593954.....37-39**  
This transmission mount is like original, vulcanized rubber on steel. 4.081-0 .....

**CALL** ⚠



**3690416.....50-51**  
Powerglide exc Convertible. 4.081-0.15  
..... **\$80.00 EA** ⚠



**3704551.....52-54**  
Passenger (Exc. PG) 1/32in. bolt head recess. 4.081-0.2  
..... **\$35.00 EA** ⚠

**Speedometer Cable**



**158829.....37-54**  
W/ original metal housing assembly. 37-48 All & 50-54 Powerglide. 70" length. 4.342-0.15  
..... **\$18.00 EA** ⚠



**158829P.....37-54**  
W/ plastic housing assembly. 37-48 & 50-54 With Powerglide 4.342-0.15  
..... **\$20.50 EA** ⚠

**1588291A.....37-57**  
Cable without housing. 85" length (0.130 dia.). 4.342-0.15  
..... **\$7.00 EA** ⚠

**1567793.....49-54**  
W/ original metal housing assembly (Exc CONV. & P.G.) 4.342-0.15  
..... **\$59.00 EA** ⚠

**Tip**



**1565706.....37-57**  
Tip, steel (speedometer end of, speedo cable). 4.342-0.3  
..... **\$13.25 EA** ⚠

**Odds And Ends**

Please call for availability on all Odds & Ends parts. Once part is sold, it may no longer be in stock.

**590481.....31-37**  
Front Main Bearing Retainer 12.000-0.4  
..... **\$25.00 EA** ⚠

**Odds And Ends, cont.**

**890517.....31-47**  
Shaft 1st & 2nd 4.241-0.4  
..... **\$30.00 EA** ⚠

**590539.....32-36**  
Reversed Idler Gear. 3-speed all, exc Standard. 12.000-0.4  
..... **\$45.00 EA** ⚠

**590550.....32-36**  
Retainer, Transmission Front Main Bearing 12.000-0.4  
..... **\$15.00 EA** ⚠

**590582N.....32-36**  
Shift Yoke-2nd & 3rd 3 Speed Pass 12.000-0.4  
..... **\$25.00 EA** ⚠

**07160.....33-35**  
Lock Ring Spacer, Ball Bearing Type 13.000-0.3  
..... **\$4.00 EA** ⚠

**590787.....33-36**  
Retainer - rear bearing trans support NOS fits CC, DC, EC, FC 4.317-0.4  
..... **\$75.00 EA** ⚠

**590801.....36**  
Gearshift Yoke 1st & Reverse. (NOS) (stand Fc) 12.000-0.4  
..... **\$15.00 EA** ⚠

**590925.....37-39**  
Reverse idler gear for 3 Speed (NOS) 12.000-0.4  
..... **\$30.00 EA** ⚠

**590927.....37-39**  
3-speed 4.421-0.3  
..... **\$160.00 EA** ⚠

**3650234.....39**  
Vacuum shift canister used 4.045-0.4  
..... **\$100.00 EA** ⚠

**3653397.....40-41**  
Yoke, U-joint, Rear, KA, KB, KC, KH & AG 13.000-0.4  
..... **\$25.00 EA** ⚠

**3653594.....40-48**  
Lower support bracket - gearshift 4.018-0.4  
..... **\$15.00 EA** ⚠

**591737.....40-48**  
Shifter Yoke, 1st & Reverse (NOS) 4.303-0  
..... **CALL** ⚠

**905207.....41-47**  
Bearing Propeller Shaft 5.436-0.4  
..... **\$30.00 EA** ⚠

**3686836.....48-54**  
Gearshift Operating Lever & Clamp 12.000-0.4  
..... **\$12.00 EA** ⚠

**591601.....48-57**  
4 Speed -3rd Non Slider 4.415-0.4  
..... **\$35.00 EA** ⚠

**954358.....48-57**  
Bearing Front On Main Drive Gear 4.355-0.4  
..... **\$24.75 EA** ⚠

**3686799.....49-52**  
Shift Lever-column 3 Speed (all Pass) 12.000-0.4  
..... **\$25.00 EA** ⚠

**591780.....49-54**  
2 & 3rd Shifter Shaft W Plate 12.000-0.4  
..... **\$12.00 EA** ⚠

**3688159.....49-55**  
Lever, Gearshift Selector, 2nd & 3rd (5-1/4in overall length), fits 49-54 pass 3sp, 53-55 DD 3sp 1st series, 4.016-0.4  
..... **\$15.00 EA** ⚠

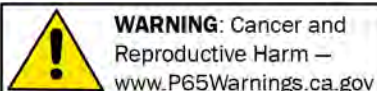

Chemicals shipped domestic ground only (Lower 48 states only). No international shipping.

Phone: (360) 816-0211 • (800) 999-CHEV (2438) • www.chevsofthe40s.com



**Odds And Ends, cont.**

- 3697514** .....50-51  
 Transmission lock shaft & spring w/ pg  
 (NOS) 4.251 -0.4 ..... **\$20.00 EA** ⚠️  
**3689857** .....50-54  
 Pass.p/g Front Yoke (NOS) 13.000 -0.4 ...  
**\$35.00 EA** ⚠️  
**3692835** .....50-54  
 Collar, U-joint Ball 50-54 Pass Powerglide  
 13.000 -0.4 ..... **\$25.00 EA** ⚠️  
**3689749** .....50-55  
 Clutch Hub, Pass W/ Powerglide  
 12.000 -0.4 ..... **\$75.00 EA** ⚠️  
**3692316** .....50-62  
 Flange Retainer Ring (nos) For Low  
 12.000 -0.4 ..... **\$5.00 PR** ⚠️  
**3694491** .....51-54  
 Reverse Band Brake Strut, P/g (NOS)  
 12.000 -0.4 ..... **\$70.00 EA** ⚠️  
**3700335** .....52-53  
 Bracket, Trans. Mount Retaining (NOS)  
 12.000 -0.4 ..... **\$25.00 EA** ⚠️  
**1507960** .....53-54  
 Oil Pressure Gauge, 53 W P/glide  
 28000.000 -0.4 ..... **\$35.00 EA** ⚠️  
**3709886** .....53-56  
 Washer Unit- Torque Converter Start  
 12.000 -0.3 ..... **\$4.00 EA** ⚠️  
**1307238** .....54-61  
 Transmission Oil Plug w/ Seal (NOS)  
 12.000 -0.4 ..... **\$6.00 EA** ⚠️  
**3836323** .....55-56  
 Clip- Retains Clutch Fork To Ball 0.823 -0.4  
 ..... **\$6.00 EA** ⚠️  
**604932N** .....ALL  
 Front Bearing Retainer (nos) 3 Speedeed  
 12000.000 -0 ..... **\$70.00 EA** ⚠️

**SECTION 160C  
 RESTORATION PARTS**

**U-Joint Assembly**

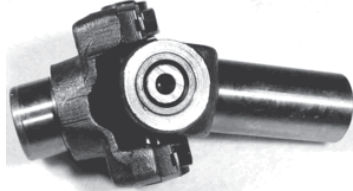

- 591642** .....49-54  
 W/ yokes (exc Powerglide). 5.548 -0 .....  
**CALL** ⚠️

**U-Joint Rebuild Kit**



- 609944** .....40-54  
 Fits car & 1/2T.  
 Includes lock plates and  
 Bolts 5.548 -0 .....  
**\$70.00 EA** ⚠️

**U-Joint Lock Plates**



- 3723489** .....40-54  
 2 plates & 4 bolts 5.586 -0.4 ..... **\$10.25 SET**  
 ⚠️

**Torque Tube**



- 3723490** .....29-54  
 Ball seal kit, for drive shaft 29-40 & 41-54  
 cars, 1/2T & 3/4T truck w/ manual trans.  
 5.572 -0.15 ..... **\$12.50 EA** ⚠️



- 3723490P** .....50-54  
 Ball seal kit, for drive  
 shaft. Fits 50-54 cars  
 w/ Powerglide.  
 5.572 -0.15 .....  
**\$23.50 EA** ⚠️

**Dowel Pin**



- 347813** .....29-50  
 5/16 in. , retains drive shaft bushing.  
 5.450 -0.3 ..... **\$7.50 EA** ⚠️

**Coupling Pin**



- 3657332** .....40-54  
 Drive shaft to pinion. 5.457 -0.2 .....  
**\$12.50 EA** ⚠️

**Drive Shaft Seal**



- 3691457** .....37-50  
 1" I.D., 1.690" O.D.  
 5.469 -0.4 ..... **\$10.00 EA**  
 ⚠️

**Drive Shaft Bushing**



- 3694733** .....51-54  
 Rear, Car & 1/2T Truck. 5.451 -0 ..... **CALL**  
 ⚠️

**Oakie Bushing**

Replaces front & rear drive shaft bushing  
 & seal without disassembling rear end and  
 driveline.



- 595005B** .....37-39  
 Car, 1/2T, 3/4T & 1T 5.451 -0.15 .....  
**\$82.00 EA** ⚠️



- 3652328B** .....40-50  
 Car and 1/2 ton truck. 5.451 -0.1 .....  
**\$99.00 EA** ⚠️



- 609930A** .....40-50  
 Oakie bushing seal  
 5.451 -0.15 .....  
**\$10.25 EA** ⚠️



- 3694733B** .....51-54  
 Car, 1/2T 5.451 -0.15 ..... **\$99.00 EA** ⚠️

**Section 160C: Drive Lines, Oakie Bushings**  
**Section 170C: Rear Axles, Bearings & Seals**

**Tool Oakie Bushing Puller**



**595005A** ..... **37-54**  
 Drive shaft bushing puller to rent (return in original condition for \$20.00 refund).  
 5.451 -0.15 ..... **\$95.00 EA** ⚠

**Odds & Ends**

Please call for availability on all Odds & Ends parts. Once part is sold, it may no longer be in stock.

**901105** ..... **33-35**  
 Pinion shaft bearing. Rear exc CC  
 13.000 -0.4 ..... **\$25.00 EA** ⚠

**601889U** ..... **33-36**  
 Universal joint assembly fits CC, DC, EC, FC 5.548 -0.4 ..... **\$100.00 EA** ⚠

**110320** ..... **34-36**  
 Bearing-pinion Shaft-rear Pass & Sedan Delivery 13.000 -0.4 ..... **\$20.00 EA** ⚠

**475995** ..... **35-36**  
 Retainer - main drive gear bearing 3 speed 4.356 -0.4 ..... **\$75.00 EA** ⚠

**602443** ..... **38-39**  
 Ring gear only used hypoid teeth 4.667 -0.4 ..... **\$75.00 EA** ⚠

**3652927** ..... **40-42**  
 Lock ring U-joint 5.586 -0 ..... **\$2.00 EA** ⚠

**SECTION 170C RESTORATION PARTS**

**Rear Axle Bearing**



**111119** ..... **37-54**  
 1937-41 uses Inner Race #111120.  
 5.855 -0.4 ..... **\$65.00 EA** ⚠

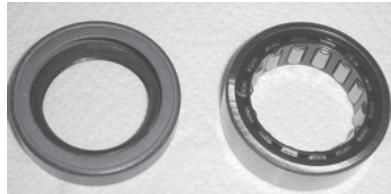

**111119B** ..... **37-54**  
 Bearing & seal, 1937-41 uses Inner Race #111120. 5.855 -0.3 ..... **\$82.00 KIT** ⚠

**Axle Bearing Inner Race**



**111120** ..... **37-41**  
 Rear axle bearing.  
 5.855 -0.2 ..... **\$46.50 EA** ⚠

**Rear Axle Bearing Seal**



**592441** ..... **33-36**  
 Passenger & Commercial. 5.822 -0.15 ..... **\$30.00 EA** ⚠

**3663166** ..... **37-54**  
 This is a rear axle bearing seal for passenger 5.822 -0.3 ..... **\$17.00 EA** ⚠

**Axle Gasket**



**593012** ..... **37-54**  
 Carrier, front center axle housing. 5.508 -0.15 ..... **\$4.75 EA** ⚠



**593017** ..... **37-54**  
 Center cover, rear axle housing. 5.399 -0.15 ..... **\$10.25 EA** ⚠

**Ring Gear Bearing**



**127861** ..... **36-54**  
 Ring gear carrier. Car uses 2 (39-40 cars w/ ball bearings must replace both). 5.536 -0 ..... **\$19.00 EA** ⚠

**Pinion Bearing**



**125630** ..... **35-54**  
 Rear. Cars; 35-54 pass & 53-55 Corvette. Trucks; 35-42 COMM, 46-54 1/2Ton 5.484 -0.3 ..... **\$74.25 EA** ⚠

**Pinion Bearing, cont.**



**954780** ..... **35-54**  
 Front, Passenger & 1/2T. 5.447 -0.15 ..... **\$27.75 EA** ⚠

**Ring & Pinion Conversion Kit**



**3705430A** ..... **40-54**  
 Chevy Car 3.55:1 (bolt in 40-50, 1937-39 requires drive line modification). 5.529 -0.15 ..... **\$386.75 SET** ⚠

**Ring & Pinion Installation Kit**

**3705430K** ..... **40-50**  
 Chevy car. Gaskets, Seals, Bearings & Shim Kits needed to install Ring & Pinion. 5.529 -0.15 ..... **\$499.00 SET** ⚠

**3705439K** ..... **51-54**  
 Chevy car. gaskets, seals, bearings 5.529 -0.15 ..... **\$499.00 EA** ⚠

**Ring & Pinion Shim Set**



**SHIMSET01** ..... **37-54**  
 Ring & Pinion Shim Set -0.2 ..... **\$110.25 EA** ⚠

**Differential Fill**



**344829** ..... **29-54**  
 Plug w/ gasket. 5.400 -0 ..... **CALL** ⚠

**Bushing Rear Spring Pivot**



**3652182A** ..... **40-54**  
 Bolt w/ nut, axle to spring pivot. 5.403 -0 ..... **\$27.25 PR** ⚠

**Odds & Ends**

Please call for availability on all Odds & Ends parts. Once part is sold, it may no longer be in stock.

**3694428** ..... **50-57**  
 Plate, Pinion Shaft Lock, All 12.000 -0.4 ..... **\$10.00 EA** ⚠

**3739435** ..... **57**  
 Rear axle bearing seal fits pass, & corvette 5.822 -0.4 ..... **\$10.00 EA** ⚠

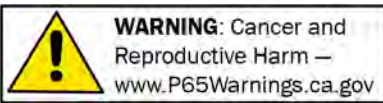

Chemicals shipped domestic ground only (Lower 48 states only). No international shipping.

**Phone: (360) 816-0211 • (800) 999-CHEV (2438) • www.chevsofthe40s.com**





# Emergency Brake Linkage

Illustrations are complete assemblies. See text for availability.

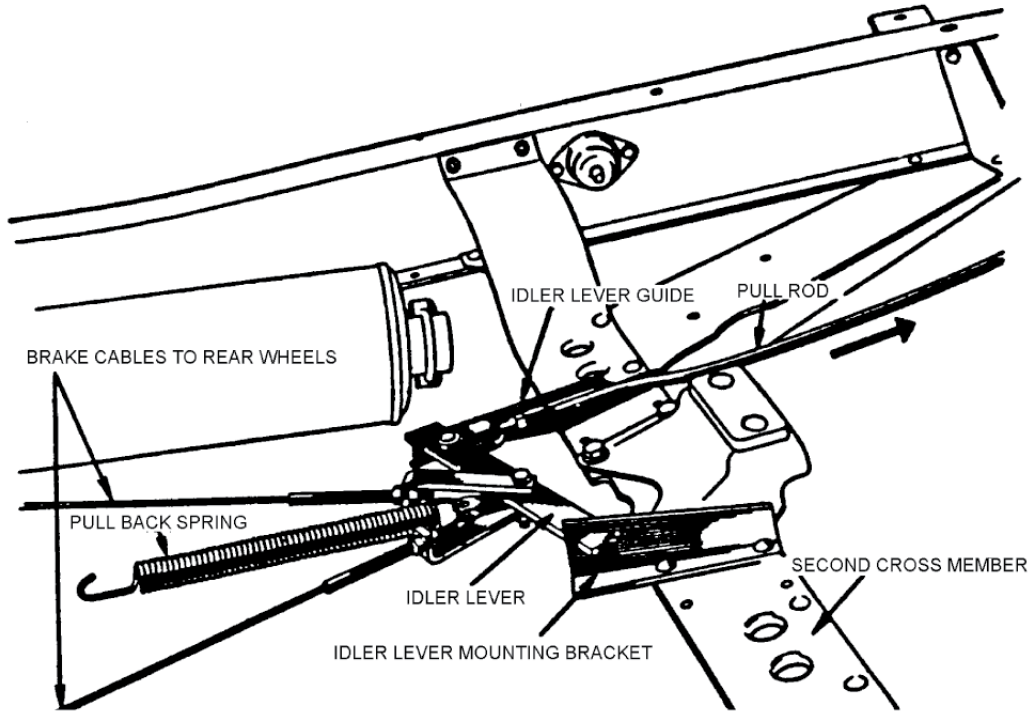

## SECTION 180C STREET ROD PARTS

### Front Disc Brake Conversion

**EC-6711SCK** ..... **28-40**  
Car & 1/2 ton truck. Complete kit for straight axles. Including rotors, calipers, pads, brackets & fasteners (brake hoses sold separately). 6x5.5" lug. Does not include bearings or seals. Uses original bearings and seals for 29-40. Inner Bearing 909002 26-40, Outer Bearing 909001 29-57, Seal 352488 29-40. -0.15  
..... **\$631.75 KIT** ⚠



**EC-711S** ..... **28-40**  
Car & 1/2 ton truck. Bracket kit only (no rotors, calipers, pads, etc). (exc. 33-36 standard cars and trucks w/ light duty spindle). -0.15 ..... **\$210.25 KIT** ⚠

### Front Disc Brake Conversion, cont.



**EC-711SCK** ..... **28-40**  
Car & 1/2 ton truck. Complete kit for straight axles. Including rotors, calipers, pads, brackets & fasteners (brake hoses sold separately). 5x4-3/4" lug. (exc. 33-36 standard cars and trucks w/ light duty spindle). -0.15 ..... **\$631.75 KIT** ⚠  
**EC-707** ..... **39-40**  
Car, Bracket kit only (no rotors, calipers, pads, etc). -0.15 ..... **\$222.75 KIT** ⚠

**EC-707CK** ..... **39-40**  
Car. Complete kit for knee action. Including rotors, calipers, pads, brackets & fasteners (brake hoses sold separately). 5 lug standard. -0.15 .. **\$631.75 KIT** ⚠

### Front Disc Brake Conversion, cont.

**EC-706** ..... **41-48**  
Car, Bracket kit only (no rotors, calipers, pads, etc). -0.15 ..... **\$210.25 KIT** ⚠

**EC-706CK** ..... **41-48**  
Car. Complete kit including rotors, calipers, pads, brackets & fasteners (brake hoses sold separately). 5 lug standard. -0.15 ..... **\$631.75 KIT** ⚠

**EC-702** ..... **49-54**  
Car, Bracket kit only (no rotors, calipers, pads, etc). -0.15 ..... **\$210.25 KIT** ⚠

**EC-702CK** ..... **49-54**  
Car. Complete kit including rotors, calipers, pads, brackets & fasteners (brake hoses sold separately). 5 lug standard. -0.1 ..... **\$631.75 KIT** ⚠

**EC-751** ..... **ALL**  
Rubber brake hose kit for ECI conversion kits. Front only. 10mm for '78-81 GM Calipers. -0.15 ..... **\$69.25 PR** ⚠

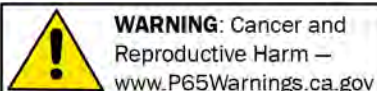

Chemicals shipped domestic ground only (Lower 48 states only). No international shipping.

**Phone: (360) 816-0211 • (800) 999-CHEV (2438) • www.chevsofthe40s.com**



**Master Cylinder Dual Reservoir For Disc Brakes**

For drum/drum use 10lb valve in front line.  
For disc/drum use 2lb valve in front line.  
Large reservoir for front, small reservoir rear.



**EC-445** ..... **ALL**  
67-72 Mustang w/ 1" bore. disc/drum applications -0.15 ..... **\$71.50 KIT** ⚠

**Master Cylinder Adapter Kit**

**EC-430** ..... **37-39**  
Adapts Mustang master cylinder (our part EC-445) to 37-39 Chevrolet passenger cars . Uses stock Chevy brake and clutch pedal (if desired) and pedal pivot shaft. Comes complete with hardware & pushrod. -0.15 ..... **\$193.00 KIT** ⚠



**EC-440** ..... **40-54**  
Adapts Mustang master cylinder (our part EC-445) to 40-54 Chevrolet passenger

cars (exc. Cabriolet/ Convertible). Uses stock Chevy brake and clutch pedal (if desired) and pedal pivot shaft. Comes complete with hardware & pushrod. Automatic transmissions only. -0.15 **\$193.00 KIT** ⚠



**EC-440S** ..... **40-54**  
Adapts Mustang master cylinder (our part EC-445) to 40-54

Chevrolet passenger car (exc. Cabriolet/ Convertible) . Uses stock Chevy brake and clutch pedal (if desired) and pedal pivot shaft. Comes complete with hardware & pushrod. Manual transmissions only. -0.15 ..... **\$246.00 KIT** ⚠

**Brake Fluid**



**5450285B** ..... **ALL**  
Master "Fade Free" DOT 4 (12 oz). 4.683 -0.15 ..... **\$7.00 EA** ⚠



**603486B** ..... **ALL**  
Mac's, DOT 5, silicone. Less corrosion. 12 ounce bottle. 4.683 -0.15 ..... **\$14.25 EA** ⚠

**Brake Cleaner**



**6129423** ..... **ALL**  
Superior cleaner. Many uses (spray can). APPLICATIONS: ABS, disc, drum, brake cylinders, brake drums, brake linings, brake shoes, calipers, clutch discs, disc brake

pads, discs. Safe for use on all brake systems including: Springs & Wedge brakes.

4.683 -0.2 ..... **\$4.00 EA** ⚠

**Line Clamp - Stainless**



**13274** ..... **ALL**  
3/16" single (12 clamps). 8.950 -0.15 ..... **\$19.75 SET** ⚠

**13275** ..... **ALL**  
3/16" x 3/8" double combination (6 clamps). 8.950 -0.15 ..... **\$19.75 SET** ⚠

**13276** ..... **ALL**  
3/16" x 3/16" double (6 clamps). 8.950 -0.15 ..... **\$18.00 SET** ⚠

**Line Clamp - Stainless, cont.**

**13277** ..... **ALL**  
1/4" single (12 clamps). 8.950 -0.15 ..... **\$22.00 SET** ⚠

**13278** ..... **ALL**  
5/16" single (12 clamps). 8.950 -0.15 ..... **\$19.75 SET** ⚠

**13279** ..... **ALL**  
3/8" single (12 clamps). 8.950 -0.15 ..... **\$19.75 SET** ⚠

**13280** ..... **ALL**  
1/2" single (12 clamps). 8.950 -0.15 ..... **\$19.75 SET** ⚠

**13281** ..... **ALL**  
5/8" single (8 clamps). 8.950 -0.15 ..... **\$22.00 SET** ⚠

**13282** ..... **ALL**  
3/4" single (8 clamps). 8.950 -0.15 ..... **\$18.00 SET** ⚠

**13283** ..... **ALL**  
7/8" single (8 clamps). 8.950 -0.15 ..... **\$18.00 SET** ⚠

**13284** ..... **ALL**  
5/16" x 3/8" double combination (6 clamps). 8.950 -0.15 ..... **\$18.00 SET** ⚠



**13285** ..... **ALL**  
1/4" x 1/4" double (6 clamps). 8.950 -0.15 ..... **\$18.00 SET** ⚠

**13286** ..... **ALL**  
5/16" x 5/16" double (6 clamps). 8.950 -0.15 ..... **\$19.75 SET** ⚠

**13287** ..... **ALL**  
3/8" x 3/8" double (6 clamps). 8.950 -0.15 ..... **\$19.75 SET** ⚠

**13288** ..... **ALL**  
1/2" x 1/2" double (6 clamps). 8.950 -0.15 ..... **\$18.00 SET** ⚠

**13289** ..... **ALL**  
5/8" x 5/8" double (4 clamps). 8.950 -0.15 ..... **\$19.75 SET** ⚠



# Section 180C: Brake Parts

## Line Clamp - Stainless, cont.

**13290**..... **ALL**  
3/4" x 3/4" double (4 clamps). 8.950 -0.15  
..... **\$20.50 SET** ⚠

**13291**..... **ALL**  
7/8" x 7/8" double (4 clamps). 8.950 -0.15  
..... **\$19.75 SET** ⚠

## SECTION 180C RESTORATION PARTS

### Emergency Brake Cable



**3654208** ..... **40**  
Takes 2 4.826 -0.15 ..... **\$100.25 EA** ⚠

**3691404** ..... **41-50**  
Takes 2 (need to reuse your clevis)  
4.826 -0.3 ..... **\$90.00 EA** ⚠

**3708808** ..... **51-54**  
Takes 2 4.826 -0.3 ..... **\$90.00 EA** ⚠

### Emergency Brake Handle



**3695735** ..... **49-52**  
Chrome. 4.592 -0.15  
..... **\$32.75 EA** ⚠



**3699301** ..... **53-54**  
Chrome. 4.592 -0.15  
..... **\$29.50 EA** ⚠



**3699301B** ..... **53-54**  
Black 4.592 -0.15 ..  
**\$25.00 EA** ⚠

### Handbrake Anti Rattle Rubber Spacer



**369387** ..... **32-39**  
Handbrake release rod  
to shift lever 4.605 -0.4  
..... **\$7.00 EA** ⚠

### Emergency Brake Cable Return Spring



**3653271** ..... **40-54**  
Emergency brake cable 4.827 -0.2  
..... **\$9.50 EA** ⚠

### Emergency Brake Cable Gasket



**476136** ..... **36-54**  
Emergency cable to  
backing plate. 4.834 -0.2  
..... **\$5.00 PR** ⚠

### Emergency Cable Boot



**3691420** ..... **37-54**  
Emergency cable to cable housing.  
4.834 -0.15 ..... **\$6.75 SET** ⚠

### Brake Overhaul Kit



**BRKHAUL** ..... **36-50**  
Brake Overhaul Kit.

Kit includes:  
Shoes & Linings for 4 wheels  
4 Wheel Cylinder Kits (rubber cups only)  
1 Master Cylinder Kit  
4 Wheel Hold Down Kits  
3 Brake Hoses  
Brake Return Springs  
4 Adjusting Hole Covers  
Fits cars and 1/2 ton trucks. 5.017 -0.15  
..... **\$239.50 KIT** ⚠

**BRKHAUL** ..... **51-52**

Brake Overhaul Kit.  
Kit includes:  
Shoes & Linings for 4 wheels  
4 Wheel Cylinder Kit (rubber cups only)  
1 Master Cylinder Kit  
4 Wheel Hold Down Kits  
3 Brake Hoses  
Brake Return Springs  
4 Adjusting Hole Covers  
Fits cars and 1/2 ton trucks. 5.017 -0.15  
..... **\$200.25 KIT** ⚠

**BRKHAUL** ..... **53-54**

Brake Overhaul Kit.  
Kit includes:  
Shoes & Linings for 4 wheels  
4 Wheel Cylinder Kit (rubber cups only)  
1 Master Cylinder Kit  
4 Wheel Hold Down Kits  
3 Brake Hoses  
Brake Return Springs  
4 Adjusting Hole Covers  
Fits cars and 1/2 ton trucks. 5.017 -0.15  
..... **\$249.50 KIT** ⚠

### Brake Shoes



**3681129** ..... **36-50**  
Front or rear 2 wheels 5.017 -0.2  
..... **\$40.00 SET** ⚠

**3695709** ..... **51-56**  
Rear 2 wheels (\$15 core) w55b.  
5.017 -0.15 ..... **\$45.25 SET** ⚠

**3696177** ..... **51-56**  
Front 2 wheels (\$15 core). 5.017 -0.15  
..... **\$39.75 SET** ⚠

### Brake Shoe Hold Down Kit



**3696704** ..... **51-54**  
2 wheels (8 pcs). 5.043 -0.15  
..... **\$8.00 SET** ⚠

### Brake Shoe Hold Down



**475506** ..... **36-50**  
J-hook (2 pcs). 1 set  
does 1 wheel 5.102 -0.3  
..... **\$2.50 SET** ⚠



**475509** ..... **36-50**  
Spring (2 pcs). 1 set  
does 1 wheel 5.046 -0.4  
..... **\$5.00 SET** ⚠

### Brake Shoe Pin Lock



**358829** ..... **30-50**  
Shoe anchor, 29/32in.  
o.d. (3 pcs). 1 set per  
wheel. 5.057 -0.2 ..  
..... **\$6.00 SET** ⚠



**358829E** ..... **30-50**  
Replacement (e-clip)  
brake shoe, 29/32in.  
o.d. (2 pcs) 5.057 -0.4  
..... **\$1.75 SET** ⚠



**WARNING:** Cancer and  
Reproductive Harm —  
www.P65Warnings.ca.gov

Chemicals shipped domestic ground only (Lower 48 states only). No international shipping.

Phone: (360) 816-0211 • (800) 999-CHEV (2438) • www.chevsofthe40s.com



# Section 180C: Brake Parts

## Brake Shoe Pin Lock, cont.



**475508.....36-50**  
Brake shoe, 9/16 in.  
O.D. (2 pcs). 1 set does  
1 wheel 5.030 -0.3  
**\$3.00 SET** ⚠



**475508E.....36-50**  
Replacement (e-clip)  
brake shoe, 9/16 in.  
O.D. (2 pcs). 1 set does  
1 wheel 5.030 -0.4

**\$1.75 SET** ⚠

## Brake Shoe Return Springs



**475511.....36-50**  
2 wheels (2 pcs) 5.026 -0  
**\$10.75 SET** ⚠

## Brake Shoe Springs

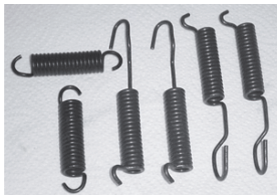

**3694822.....51-54**  
Return & adjusting, Passenger & 1/2Ton  
(does 2 wheels) (6 pcs). 5.026 -0.15  
**\$9.00 SET** ⚠

## Brake Adjust Hole Cover



**475516.....36-54**  
Plugs (original metal) (8  
pcs). 5.188 -0.3

**\$17.00 SET** ⚠



**475516B.....36-54**  
Plugs (rubber) (8 pcs).  
5.188 -0.4  
**\$6.75 SET** ⚠

## Adjuster Assembly



**496351B.....51-57**  
Brake shoe w/ star  
wheel, fits Passenger &  
1/2T. 5.110 -0.15  
**\$15.00 EA** ⚠

## Brake Drum



**601985.....36-39**  
Front or Rear (Except  
straight axle front). 6  
on 5-1/2 in. bolt  
pattern. 5.809 -0.15

**\$89.50 EA** ⚠

## Brake Drum, cont.



**602432A.....36-40**  
Front Passenger, Sedan  
Delivery, Master (6 lug).  
6 on 5-1/2 in. bolt  
pattern. (Straight axle  
only) 5.809 -0.15  
**\$125.00 EA** ⚠



**3717781.....51-60**  
Front or rear. 5.809 -0.15  
**\$69.25 EA** ⚠

## Tinnerman Nuts



**365897.....ALL**  
Retains rear brake  
drum (6 pcs). 5.810 -0  
**\$7.50 SET** ⚠

## Gasket -Brake Drum



**365673.....29-48**  
Front or rear (6 lug)  
5.819 -0.15  
**\$3.75 PR** ⚠



**3687628.....49-62**  
Front or rear (5 lug)  
5.819 -0.15  
**\$5.00 PR** ⚠

## Brake Hose



**476719.....36-50**  
Takes 3 4.680 -0.2  
**\$18.00 EA** ⚠  
**3696551.....51-57**  
Takes 3. (Except 3/4 ton) 4.680 -0.15  
**\$14.50 EA** ⚠

## Copper Washer



**231343.....36-57**  
For brake hose (3 pcs).  
4.671 -0.4  
**\$5.25 SET** ⚠

## U-clip



**334961.....36-57**  
For brake hose to frame  
(uses 3) (3 piece set).  
4.681 -0.4  
**\$3.00 SET** ⚠

## Brake Line Sets

Oversize shipping charges apply to all Brake Line Sets. Please call for rate.



**3696822.....37-54**  
Steel. Designed to fit your vehicle.  
Matches original lines (specify year when  
ordering). 4.865 -0 .....starting  
at **\$145.00 SET** ⚠  
**369682S.....37-54**  
Stainless Steel. Designed to fit your  
vehicle. Matches original lines (specify  
year when ordering). 4.865 -0 .....starting  
at **\$170.00 SET** ⚠

## Master Cylinder



**5450257.....36**  
Standard & Sedan Delivery (\$100 core)  
4.650 -0.2  
**\$250.00 EA** ⚠



**5450392.....37-39**  
Resleeved & rebuilt. \$50 core 4.650 -0  
**\$249.75 EA** ⚠



**5450392E.....37-39**  
New. 4.650 -0.15  
**\$193.25 EA** ⚠  
**5453738R.....40-42**  
Stick shift. Will work on Powerglide using  
part # PGCONV (\$50 core). Rebuilt. has  
1/8NPT hole for Stop Light Switch 4.650 -0  
**\$249.75 EA** ⚠

Returns require a return authorization number—call first. • Product pricing & availability subject to change.

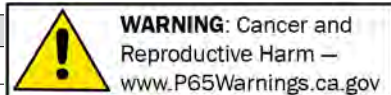

**Master Cylinder, cont.**



**5453737** ..... **40-52**  
New. Exc Powerglide 4.650 -0.15 .....  
**\$180.50 EA** ⚠

**5453737R** ..... **40-52**  
Stick shift. Will work on Powerglide using  
part # PGCONV (\$35 core). Rebuilt. 4.650 -0  
.....  
**\$249.75 EA** ⚠



**5453735R** ..... **50-52**  
Powerglide Rebuilt  
(\$100 Core) 4.650 -0.15  
.....  
**\$249.75 EA** ⚠



**5454126** ..... **53-54**  
New. Exc Powerglide 4.650 -0.15 .....  
**\$177.25 EA** ⚠

**5454126R** ..... **53-54**  
Rebuilt. Exc Powerglide 4.650 -0  
.....  
**\$275.00 EA** ⚠

**5454135R** ..... **53-54**  
Powerglide Rebuilt (\$100 Core) 4.650 -0.15  
.....  
**\$275.00 EA** ⚠

**Master Cylinder Rebuild Kit**



**5453950** ..... **36-52**  
1 in. bore 4.650 -0.15 .....  
**\$20.00 EA** ⚠

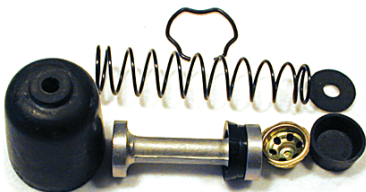

**5454218** ..... **53-54**  
7/8in. bore 4.650 -0.15 .....  
**\$31.00 EA** ⚠

**Master Cylinder Gaskets**



**043234** ..... **37-54**  
Master cylinder plug 4.651 -0.15 .....  
**\$1.50 EA** ⚠

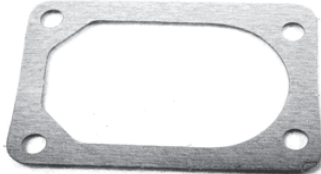

**5300973** ..... **37-54**  
Master cylinder cover (rectangular)  
4.663 -0.15 .....  
**\$2.00 EA** ⚠

**Master Cylinder Rubber Boot**



**5450551** ..... **36-57**  
On master cylinder.  
4.659 -0.15 .....  
**\$9.75 EA** ⚠

**Master Cylinder Pin Lock Brake Pedal Shaft**



**127875A** ..... **40-54**  
Exc Powerglide 4.626 -0.3  
.....  
**\$20.00 EA** ⚠



**127875B** ..... **40-54**  
Powerglide. 4.626 -0.15  
.....  
**\$35.00 EA** ⚠

**Master Cylinder Adapter Kit**

**PGCONV1** ..... **50-54**  
Use this kit to convert a standard master  
cylinder to work in your powerglide car or  
keep your standard master cylinder when  
converting to automatic.. Use with  
5453737 40-52 or 5454126 53-54 -0.15  
.....  
**\$55.00 EA** ⚠

**Master Cylinder Bushings**



**3682074** ..... **37-54**  
Master cylinder for  
clutch & brake pedal  
shaft (trim to length for  
40-54) (13/16 in. O.D. x 3/4 in. I.D. x  
1-25/64 in. Long) 4.827 -0.15 .....  
**\$27.00 PR** ⚠

**Brake Pedal Return Spring**



**3698665** ..... **40-54**  
Overall length 5-3/4in. 4.827 -0.2 .....  
**\$10.00 EA** ⚠

**Plug In Floor**

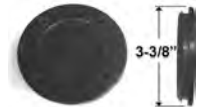

**592865** ..... **36-54**  
Master cylinder  
inspection (in floor).  
3-3/8 in. diameter for 3  
in. hole. 12.541 -0.15  
.....  
**\$8.00 EA** ⚠

**Wheel Cylinder Front**



**5300953** ..... **36-48**  
Front right (also fits left 37-38 GB, HB)  
4.665 -0.15 .....  
**\$50.00 EA** ⚠  
**5300954** ..... **36-48**  
Front left (also fits front right 37-38 GB,  
HB) 4.665 -0.15 .....  
**\$50.00 EA** ⚠

**5300866** ..... **36-FC**  
Front. Straight axle. 4.665 -0.15 .....  
**\$40.00 EA** ⚠

**5300869** ..... **36-FD**  
Front. Knee action. 4.665 -0.15 .....  
**\$39.50 EA** ⚠

**5450988** ..... **49-50**  
Front 1/16, undersized, right 4.665 -0.15  
.....  
**\$50.00 EA** ⚠

**5450989** ..... **49-50**  
Front 1/16, undersized, left 4.665 -0.15  
.....  
**\$50.00 EA** ⚠

**5455478L** ..... **51-54**  
Front left. Also fits 53-57 Corvette.  
4.665 -0.15 .....  
**\$28.00 EA** ⚠

**5455479R** ..... **51-54**  
Front right. Also fits 53-57 Corvette.  
4.665 -0.15 .....  
**\$28.00 EA** ⚠

**Wheel Cylinder Rear**



**5300866** ..... **36-48**  
Rear (exc FC) 4.665 -0.15 .....  
**\$40.00 EA**  
⚠

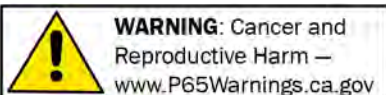

**WARNING:** Cancer and  
Reproductive Harm —  
www.P65Warnings.ca.gov

Chemicals shipped domestic ground only (Lower 48 states only). No international shipping.

**Phone: (360) 816-0211 • (800) 999-CHEV (2438) • www.chevsofthe40s.com**



# Section 180C: Brake Parts

## Wheel Cylinder Rear, cont.

**5300867** ..... **49-50**  
Rear 1/16, oversized 4.665 -0.15 .....  
**\$40.00 EA** ⚠

**5453819** ..... **51-54**  
Rear. Also fits 53-55 Corvette. 4.665 -0.15  
..... **\$28.00 EA** ⚠

## Wheel Cylinder Rebuild Kit Front



**5450431** ..... **36-48**  
Front (1-1/4 in. bore) 4.665 -0.15 .....  
**\$18.00 EA** ⚠



**5453709** ..... **49-50**  
Front (1-5/16in. bore) 4.665 -0.15 .....  
**\$15.00 EA** ⚠



**5455661A** ..... **51-57**  
Front (1-1/8 in. bore) 4.665 -0.15 .....  
**\$7.00 EA** ⚠

## Wheel Cylinder Rebuild Kit Rear



**5450429** ..... **36-48**  
Rear (1-3/16 in. bore) 4.665 -0.15 .....  
**\$23.50 EA** ⚠



**5450427** ..... **49-50**  
Rear (1-1/8in. bore) 4.665 -0.15 .....  
**\$24.00 EA** ⚠

## Wheel Cylinder Rebuild Kit Rear, cont.



**5455660** ..... **51-57**  
Rear (1 in. bore) 4.665 -0.2 ..... **\$11.50 EA**  
⚠

## Wheel Cylinder Rod



**509233** ..... **51-57**  
Rod connecting wheel cylinder to brake shoes 4.675 -0.3 ..... **\$4.00 EA** ⚠

## Brake Line Junction Block



**476100** ..... **36-50**  
Block for rear line to wheel cylinder. Fits 1936-50 ALL, 51-57 3/4Ton, 1Ton & Utility. 4.686 -0.15 ..... **\$24.25 EA** ⚠



**497756** ..... **36-57**  
Block for rear brake hose at rear axle housing. Fits 1936-50 All, 1951-57 3/4Ton, 1Ton & Utility. 4.686 -0.15 ..... **\$25.50 EA** ⚠



**3692044** ..... **47-57**  
Block. Front brake line at master cylinder. Fits 49-54 Convertible & 47-53 Chevy trucks. Includes nut. 4.686 -0.15 .. **\$36.00 EA** ⚠



**3696540** ..... **51-54**  
Block, left front brake line at master cylinder. Fits 1951-54 PASS (EXC. CONV) & 52-54 1/2Ton. 4.686 -0 ..... **CALL** ⚠

**3696553** ..... **51-55**  
Block for rear line to wheel cylinder. Fits 51-54 Pass, 51-55 1st Ser 1/2ton, 53-55 Corvette -0 ..... **\$22.25 EA** ⚠



**3696552** ..... **51-57**  
Block for rear brake hose at rear axle housing. Fits 1951-57 Pass. & 1/2Ton. 4.686 -0.15 ..... **\$23.00 EA** ⚠

## Brake Line Junction Bolt



**476099** ..... **36-50**  
Brake line junction block bolt. Fits 36-50 all (inc. GMC) 4.686 -0.15 ..... **\$9.00 EA** ⚠

## Bleeder Valve



**5300926** ..... **36-57**  
Wheel cylinder. 4.666 -0.2 ..... **\$1.50 EA** ⚠

## Clip



**148129A** ..... **ALL**  
Double ended, holds 1/4in. brake & 5/16 in. gas line to frame (snaps into hole). 8.950 -0.4 ..... **\$5.75 EA** ⚠



**3735074C** ..... **ALL**  
3/8 in. slot, gas, brake line, wire harness (4 pcs). 8.950 -0.15 ... **\$8.25 SET** ⚠

## Brake Light Switch



**1997725** ..... **36-40**  
Hydraulic, Screw on terminal 2.447 -0 ... **\$13.00 EA** ⚠



**403936** ..... **41**  
Hydraulic. Exc. COE. Press on terminal 2.447 -0.2 ..... **\$18.50 EA** ⚠



**1997901** ..... **42-50**  
Mechanical 2.447 -0.2 ..... **\$13.50 EA** ⚠



**1997913** ..... **51-54**  
Exc 54 w/ power brakes. 2.447 -0.3 ... **\$18.75 EA** ⚠

## Brake Light Switch T Fitting



**652B** ..... **ALL**  
Add a hydraulic brake light switch to your 3/16" brake line. -0.4 ..... **\$12.00 EA** ⚠

Returns require a return authorization number—call first. • Product pricing & availability subject to change.

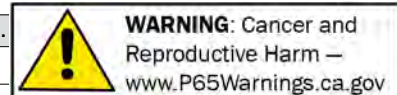

## Section 180C: Brake Parts

## Section 190C: Steering Columns, Shafts, Rebuild Kits, Steering Components & Related

### Brake Light Switch T Fitting, cont.

**652C** ..... **ALL**  
Add a hydraulic brake light switch to your  
1/4" brake line. -0 ..... **CALL** ⚠

### Odds And Ends

Please call for availability on all Odds & Ends  
parts. Once part is sold, it may no longer be in  
stock.

**472677** ..... **33-35**  
Brake Cable, Front, CC,DC & EC (NOS)  
14.000 -0.4 ..... **\$65.00 EA** ⚠

**475545** ..... **36-38**  
Flange radius rod left hand for front brake  
(NOS) 5.004 -0.4 ..... **\$25.00 EA** ⚠

**475545N** ..... **36-38**  
Flange bracket to radius rod left (NOS) fits  
FA, GA, HA & Master Deluxe (with knee  
action) 5.004 -0.4 ..... **\$50.00 EA** ⚠

**5300953P** ..... **36-48**  
Wheel cylinder - partial (fits 39-48 right  
front, 37-38 left rear GB, HB partials)  
4.665 -0 ..... **\$5.00 EA** ⚠

**5300954N** ..... **36-48**  
Wheel cylinder front left (also fits front  
right 37-38 GB, HB) 4.665 -0.4 ..... **\$90.00 EA**  
⚠

**5450431N** ..... **36-48**  
Wheel brake cylinder spring & cups. Front  
for 1-1/4 in. bore, Delco NOS. 4.665 -0.4  
**\$15.00 SET** ⚠

**592420U** ..... **36-50**  
Pin for brake link used 5.036 -0 .....  
**\$15.00 EA** ⚠

**605411** ..... **41-47**  
Rod & Pawl, Parking Brake Lever 4.594 -0.4  
..... **\$25.00 EA** ⚠

**5300804** ..... **49-50**  
Wheel cylinder rear, adjusting gear w/  
cover (NOS) 4.674 -0 ..... **\$4.00 EA** ⚠

**5450993** ..... **49-50**  
Wheel brake cylinder cups 4.667 -0.15 ...  
**\$2.00 EA** ⚠

### Odds And Ends, cont.

**3693451** ..... **51-55**  
Backing Plate, Rear Left fits 51-54  
Passenger, 53-55 Corvette, 51-55 1/2Ton  
(1st series) 5.001 -0.4 ..... **\$35.00 EA** ⚠

**3693452** ..... **51-55**  
Brake backing plate right side 5.001 -0.4  
**\$34.00 EA** ⚠

**496351** ..... **51-62**  
Brake shoe star wheel adjuster (NOS)  
5.110 -0.4 ..... **\$8.00 EA** ⚠

**5300866U** ..... **54-60**  
Wheel cylinder NOS shelf worn 4.665 -0.4  
**\$50.00 EA** ⚠

**5300800** ..... **ALL**  
Wheel cylinder cup 1-3/16 in 4.667 -0.15  
**\$2.00 EA** ⚠

## SECTION 190C RESTORATION PARTS

Note: Steering wheels, horn buttons & bars  
see Section 55C.

### Insulator

 **3681057A** ..... **37-39**  
Steering column to  
dash, brown. 6.758 -0.15 ..... **\$26.00 EA**  
⚠

 **3685524** ..... **37-39**  
Steering column to  
dash, black. 1-1/4 in. 6.758 -0.4 .....  
**\$3.25 EA** ⚠

 **3664758** ..... **41-48**  
Steering column to  
dash. 6.764 -0.15  
**\$3.25 EA** ⚠

### Steering Column Grommet

 **594344** ..... **37-38**  
Steering column at  
floor. 6.758 -0.15  
**\$33.75 EA** ⚠

 **350617** ..... **39**  
Steering column at floor  
shift. 6.758 -0.15  
**\$33.75 EA** ⚠

 **3650395** ..... **39**  
Steering column at  
floor, column shift.  
6.758 -0.15 .....  
**\$57.75 EA** ⚠

 **3653690** ..... **40-48**  
Steering column at  
floor, brown. 6.758 -0.4  
..... **\$13.50 EA** ⚠

 **3653690A** ..... **40-48**  
Steering column at  
floor, black. 6.758 -0.15  
..... **\$28.75 EA** ⚠

 **3653690AE** ..... **40-48**  
Steering column at  
floor, black. 6.758 -0.15  
..... **\$71.25 EA** ⚠



**WARNING:** Cancer and  
Reproductive Harm —  
www.P65Warnings.ca.gov

Chemicals shipped domestic ground only (Lower 48 states only). No international shipping.

Phone: (360) 816-0211 • (800) 999-CHEV (2438) • www.chevsofthe40s.com



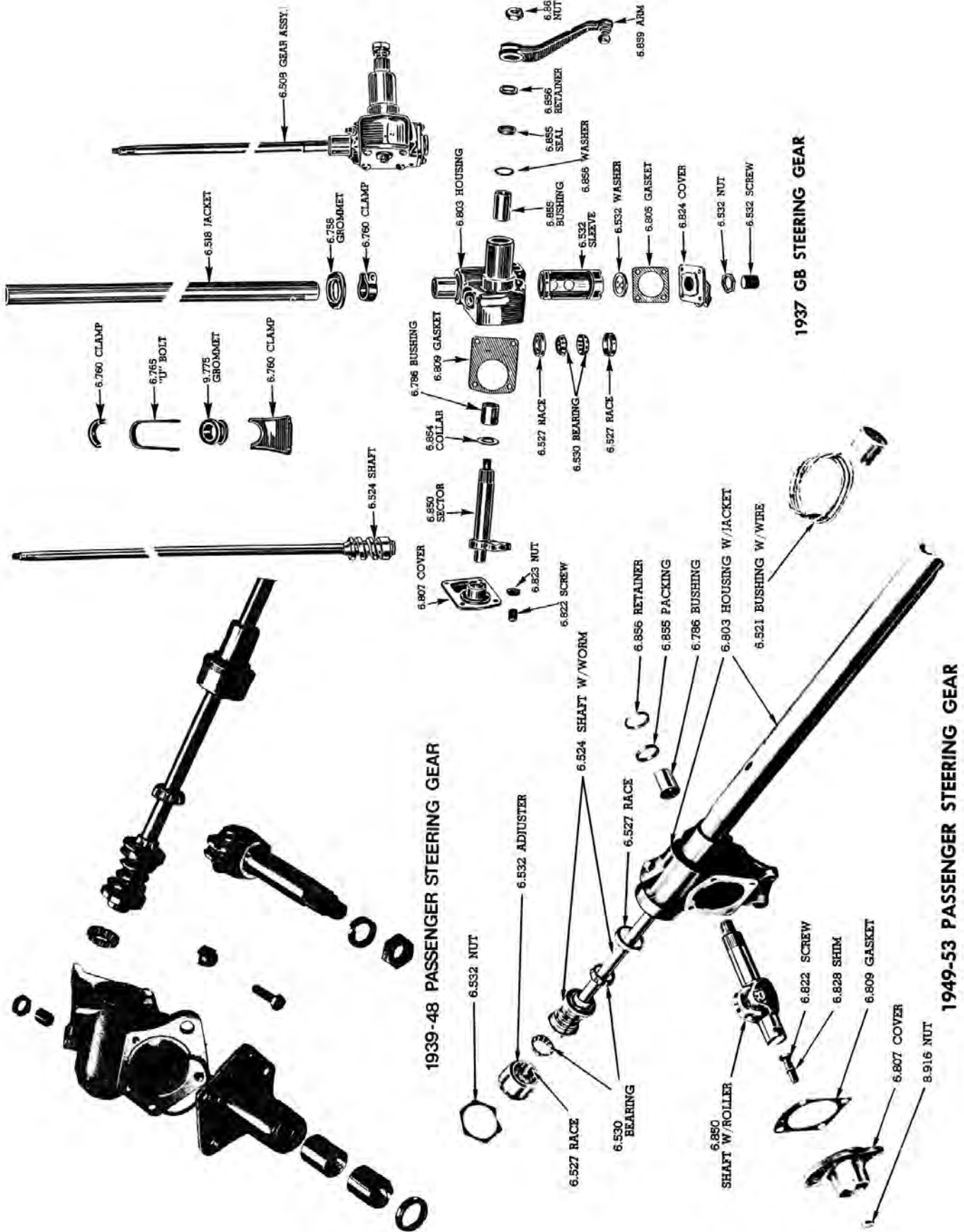

Returns require a return authorization number—call first. • Product pricing & availability subject to change.

**WARNING:** Cancer and Reproductive Harm — www.P65Warnings.ca.gov

**Steering Column Grommet, cont.**



**3691548.....49-54**  
Steering column at floor. Ribbed rubber.  
6.758-0 ..... **CALL**  
⚠



**3691548E.....49-54**  
Steering column at floor. Ribbed rubber.  
MADE IN USA  
6.758-0.15 .....

**\$91.25 EA** ⚠

**3691548F.....49-54**  
Steering column at floor. Ribbed rubber.  
6.758-0 ..... **\$16.00 EA** ⚠

**Steering Column Foam Seal**



**594340.....37-38**  
Steering column at floor. 6.758-0.15  
**\$24.75 EA** ⚠



**3653713.....40-48**  
Steering column at floor. 6.758-0.3  
**\$6.75 EA** ⚠



**3691549.....49-54**  
Steering column at floor. 6.758-0.4  
**\$8.75 EA** ⚠

**Seal Metal Shield To Frame**



**3688673.....49-51**  
Metal shield to frame.  
6.797-0.4 .....

**\$4.25 EA** ⚠

**Belt**



**3703633.....53-54**  
Power steering pump. 1.066-0.2 .....

**\$8.25 EA** ⚠

**Steering Gear Shaft With Worm**

Oversize shipping will apply.

**5660219.....49-50**  
Worm Gear & Shaft (50 1st Design)  
6.524-0.4 ..... **\$250.00 EA** ⚠

**Steering Gear Overhaul Kit**

Note: Steering gear overhaul kits do not include worm gear, pitman shaft or sector shaft. Those items sold separately.



**263624R.....37**  
Straight axle-includes bushings, seal, races, bearings. 6.524-0.15 .....

**\$104.00 KIT** ⚠

**609939B.....37-38**  
Exc 37 straight axle (includes gasket, bushings, seal, races, bearings).  
6.524-0.15 ..... **\$105.00 KIT** ⚠

**265805B.....39-40**  
Straight axle (includes gasket, bushings, seal, races, bearings). 6.524-0.15 ...

**\$105.00 KIT** ⚠

**264814B.....39-48**  
Knee action (includes gasket, bushings, seal & bearings). 6.524-0.2 .....

**\$120.75 KIT** ⚠

**3690519R.....49-50**  
Includes bushings, seal, races, bearings.  
6.524-0.15 ..... **\$100.00 KIT** ⚠

**3690519R.....51-52**  
Includes bushings, seal, races, bearings.  
6.524-0.15 ..... **\$100.00 KIT** ⚠



**5680153B.....53-54**  
Steering gear overhaul kit for power steering. 6.057-0.15 ... **\$131.75 SET** ⚠

**Steering Gear Overhaul Kit**



**5680928B.....53-54**  
Steering gear overhaul kit. W/ Manual steering 6.524-0.15 ... **\$66.50 EA** ⚠

**Steering Worm Gear Balls**



**206800.....53-57**  
On ball nut steering worm gear (53-54 w/ power steering & all 55-57) (30 pcs).  
..... **\$8.25 SET** ⚠

6.844-0.4

**Steering Gear Gasket Kit**



**5680153.....53-54**  
Gasket & seal kit-power steering. 6.507-0  
..... **CALL** ⚠

**Power Steering**



**5665833.....53-54**  
Pump seal kit 6.617-0.15  
..... **\$41.00 EA** ⚠

**Steering Worm Gear Bearings**



**261866B.....34-54**  
Thrust bearing (2) & race (2) 34-36 DA, EA, FA; 37-54; & 53-57 Corvette exc power steering. 6.530-0.15  
..... **\$44.00 PR** ⚠

**Pitman Shaft**

**263543.....37**  
Knee action (GA). 6.850-0.4  
**\$85.00 EA** ⚠



**263624A.....37**  
Straight axle (GB). 6.850-0.3  
**\$85.00 EA** ⚠

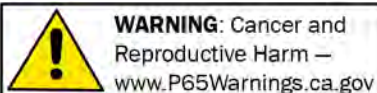

**WARNING: Cancer and Reproductive Harm** —  
www.P65Warnings.ca.gov

Chemicals shipped domestic ground only (Lower 48 states only). No international shipping.

**Phone: (360) 816-0211 • (800) 999-CHEV (2438) • www.chevsofthe40s.com**



**Pitman Shaft, cont.**

**264275..... 38**  
Knee action (HA). 6.850 -0.4 **\$85.00 EA**  
▲

**609940..... 38-39**  
Straight axle (HB, JB). 6.850 -0 ..... **CALL**  
▲

**609935..... 40**  
Straight axle (KB). 6.850 -0.4 **\$85.00 EA**  
▲

**Pitman Shaft Seal**



**262155..... 35-57**  
35-38 knee action,  
37-40 straight axle &  
49-57 exc 53-54  
standard steering.  
6.855 -0.1 ..... **\$10.00 EA** ▲

**270289..... 39-57**  
39-48 w/ knee action, 53-54 exc power  
steering & 53-57 Corvette. 6.855 -0.3 ...  
**\$12.50 EA** ▲

**Pitman Shaft Screw**



**266678..... 41-57**  
Adjuster for pitman  
shaft. 6.822 -0 **CALL**  
▲

**Pitman Shaft Bushing**



**266316..... 34-54**  
Pitman shaft.  
Length=1.350",  
I.D.=1.130",  
O.D.=1.250". 6.786 -0.3  
..... **\$25.25 EA** ▲

**Pitman Arm Bushing**



**350390..... 39**  
Rubber w/ metal insert,  
beam axle (takes 2) (2  
piece set). 6.862 -0  
**CALL** ▲



**599643..... 39-48**  
Exc beam axle (takes 4)  
(4 piece set). 6.862 -0.4  
..... **\$14.25 SET** ▲

**Steering Gear Gasket**



**261883..... 34-48**  
Cork, 2-1/2in. i.d. x  
5/64in. , steering gear  
housing to pitman gear  
housing, exc 37 GB

straight axle. 6.805 -0.3 .. **\$4.50 EA**  
▲

**Steering Wheel Bushing With Horn Wire**



**1854761..... 31-39**  
Bushing under steering  
wheel W/ horn wire

6.521 -0 ..... **\$82.50 EA** ▲

**Steering Wheel Bearing With Horn Wire**



**264887..... 39-48**  
Bearing under  
steering wheel, w/  
horn wire - exc  
beam axle (JB, KB).  
6.521 -0.4  
..... **\$25.00 EA** ▲



**270255..... 49-54**  
Bearing under  
steering wheel, w/  
horn wire. Except  
power steering.

6.521 -0 ..... **\$48.00 EA** ▲

**Tie Rod Long**



**367528..... 32-36**  
Rod only, exc CC, DC, EC, FC. 43-1/4"  
long. 6.230 -0.15 ..... **\$40.00 EA** ▲

**605923B..... 39-48**  
W/ adjustable ends (knee action).  
6.230 -0.15 ..... **\$141.00 EA** ▲



**3692953..... 49-54**  
Comes with ends. 6.230 -0.2 .....  
**\$130.00 EA** ▲

**Tie Rod Short**

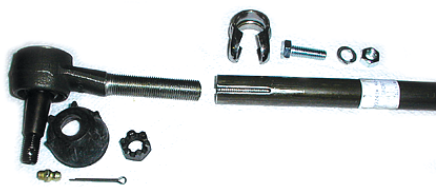

**599241B..... 39-48**  
W/ tie rod ends. 6.230 -0.15 **\$142.00 EA**  
▲

**Tie Rod Short, cont.**

**3691181B..... 49-54**  
W/ tie rod ends. 6.230 -0.15 . **\$109.00 EA**  
▲

**Tie Rod End Rebuild Kit**



**608840..... 32-40**  
Includes plugs, springs  
& seats, modification  
required (exc. 39-48  
knee action). 6.874 -0.15 . **\$30.00 PR** ▲

**Tie Rod End**



**374226R..... 32-40**  
Exc knee action, replaces ball & original  
socket type, right. 6.233 -0.15 .....  
**\$45.00 EA** ▲

**374227L..... 32-40**  
Exc knee action, replaces ball & original  
socket type, left. 6.233 -0.15 .. **\$45.00 EA**  
▲

**Tie Rod End (Knee Action)**

**472664..... 39-54**  
Right 6.233 -0.15 ..... **\$36.00 EA** ▲



**472665..... 39-54**  
Left 6.233 -0.15 ..... **\$36.00 EA** ▲

**Rubber Seal**



**3687643..... 39-54**  
Tie rod end (knee  
action) (2 pcs). 6.111 -0.3  
..... **\$7.00 SET** ▲

**Tie Rod End Clamps**



**599234..... 40-54**  
6.230 -0.3 .....  
**\$10.50 SET** ▲

**Drag Link Rebuild Kit**



**608840.....32-54**  
Includes plugs, springs & seats, modification required (exc. 39-48 knee action). 6.874-0.15 ..... **\$30.00 PR** ⚠

**Drag Link Seals**



**3705009.....32-40**  
2-1/4 in. long, rubber replacement (2 pcs). 6.886-0 ..... **\$20.25 SET** ⚠



**3705009A.....32-40**  
2-7/8 in. long, metal, original style. 6.886-0.15 ..... **\$22.00 SET** ⚠  
**3705009.....49-54**  
2-1/4 in. long, rubber replacement (2 pcs). 6.886-0.15 ..... **\$27.75 SET** ⚠  
**3705009A.....49-54**  
2-7/8 in. long, metal, original style. 6.886-0.15 ..... **\$22.00 SET** ⚠

**Idler Arm**



**3696372.....49-54**  
Pivot pin repair kit. 6.181-0.15 ..... **\$39.50 KIT** ⚠

**Odds & Ends**

Please call for availability on all Odds & Ends parts. Once part is sold, it may no longer be in stock.

**374226N.....32-56**  
Tie rod end left (4-59/64 in) (25/36-16 right hand thread) Stamped R. Fits 32-34 all exc CC & DC, 35-38 Pass, COMM exc EC, FC, GB & HB, 39-42 COMM, 46-56 1/2T & 3/4T exc DD. 6.233-0.4 ..... **\$35.00 EA** ⚠

**Odds & Ends, cont.**

**374227N.....32-56**  
Tie rod end. Left side. (4-59/64in.) (25/36-16 left hand thread) Stamped L. Fits 32-34 all exc CC & DC, 35-38 Pass, COMM exc EC, FC, GB & HB, 39-42 COMM, 46-56 1/2T & 3/4T exc DD. 6.233-0.4 ..... **\$35.00 EA** ⚠

**265460U.....34-40**  
Adj screw assy for steering gear 6.532-0.4 ..... **\$10.00 EA** ⚠

**262810.....35-36**  
Sector, Model Ed & Fd 6.850-0.4 ..... **\$65.00 EA** ⚠

**262155N.....35-57**  
Pitman shaft seal, cork. Fits 35-38 knee action, 37-40 straight axle & 49-57 exc 53-54 standard steering, 6.855-0.4 ..... **\$10.00 EA** ⚠

**603481.....37**  
Steering connecting rod fits GB missing internal parts 6.870-0.4 ..... **\$75.00 EA** ⚠

**985147U.....37**  
Banjo wheel, needs to be restored 6.513-0 ..... **\$350.00 EA** ⚠

**594153.....37-38**  
Steering Connecting Rod ( Door Ag Link) fits GA & HA 6.870-0.4 ..... **\$75.00 EA** ⚠

**753325.....38-40**  
Steering wheel fits all except JA, KA, KB, KH & COE (Used) 6.513-0 ..... **\$100.00 EA** ⚠

**603476U.....39**  
Hood Ornament Accy Used 19.000-0 ..... **\$125.00 EA** ⚠

**3667231.....39-48**  
Steering Knuckle Arm, Left, W/ Knee Action 15.000-0.4 ..... **\$35.00 EA** ⚠

**3667232.....39-48**  
Steering Knuckle Arm, Right, Knee Action 15.000-0.4 ..... **\$35.00 EA** ⚠

**599189.....39-48**  
Steering Knuckle Support- Left, Nors 15.000-0.4 ..... **\$35.00 EA** ⚠

**Odds & Ends, cont.**

**265761N.....40-48**  
Housing, Steering Gear Assy (NOS) 15.000-0.4 ..... **\$45.00 EA** ⚠

**3687865.....49-50**  
Steering Knuckle Spacer (NOS) 15.000-0.4 ..... **\$10.00 EA** ⚠

**3691175.....49-50**  
Steering arm left 6.103-0 ..... **\$25.00 EA** ⚠

**3687651.....49-52**  
Steering Knuckle Support, Left (NOS) 15.000-0.4 ..... **\$35.00 EA** ⚠

**3709275.....49-54**  
Steering Knuckle Arm, Left (NOS) 15.000-0.4 ..... **\$35.00 EA** ⚠

**3694328.....50**  
Swivel control lever, all PG (2-11/16in. overall length) 4.006-0 ..... **\$12.00 EA** ⚠

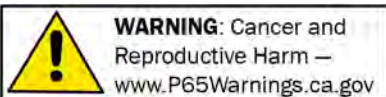

Chemicals shipped domestic ground only (Lower 48 states only). No international shipping.

**Phone: (360) 816-0211 • (800) 999-CHEV (2438) • www.chevsofthe40s.com**





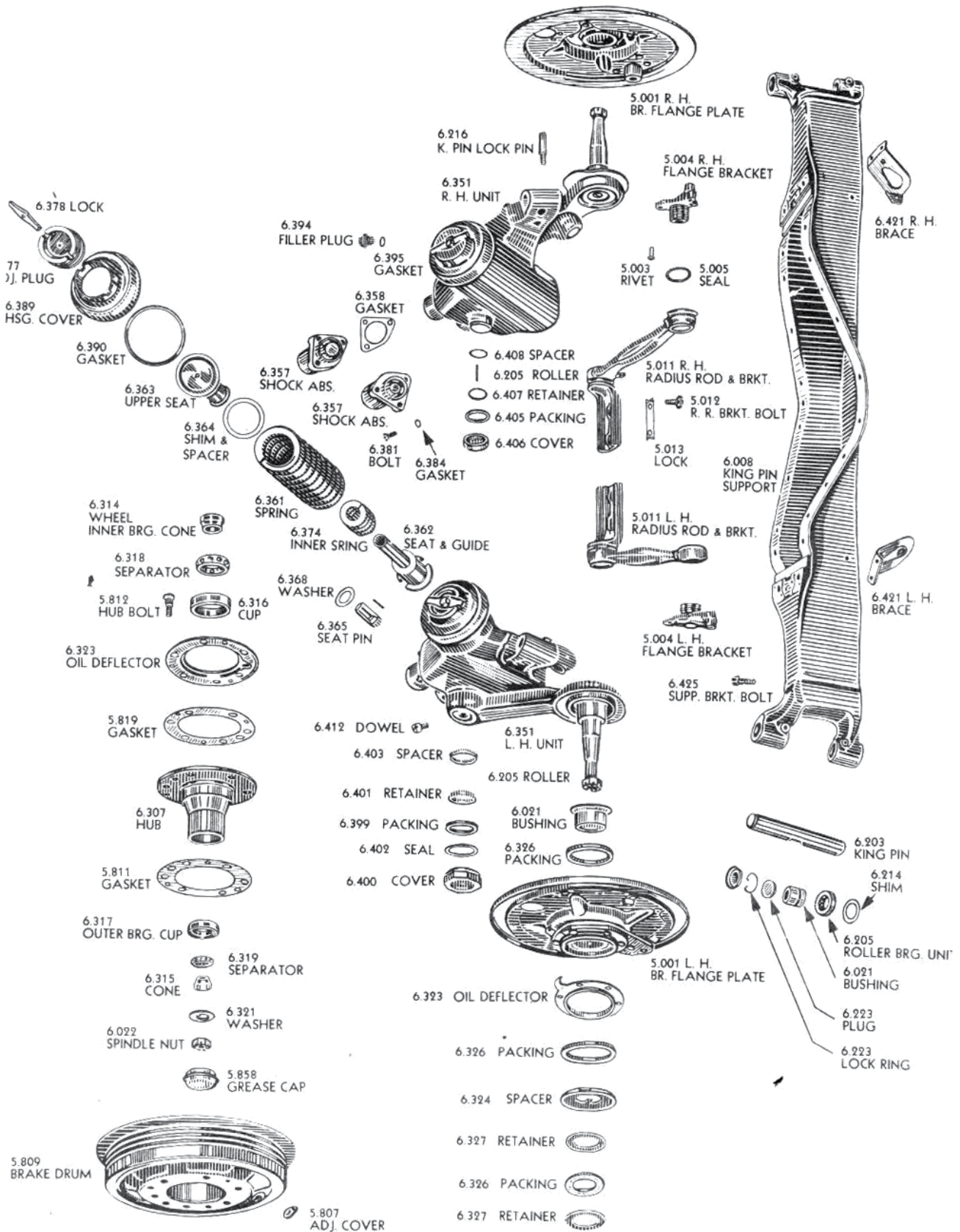

**KNEE ACTION PARTS—ENCLOSED TYPE**



**WARNING: Cancer and Reproductive Harm —**  
www.P65Warnings.ca.gov

Chemicals shipped domestic ground only (Lower 48 states only). No international shipping.  
Phone: (360) 816-0211 • (800) 999-CHEV (2438) • www.chevsofthe40s.com

200C



**SECTION 200C  
STREET ROD PARTS**

**C5 Corvette Suspension Conversion**



**C5CONV** .....39-48  
C5 Corvette Suspension Conversion. Bolt on front crossmember.  
Fits 39-48 Chevy car & sedan delivery (exc. straight axle) using your C5 suspension components. Requires C5RACK & C5SHOCKLMF. -0.15 .....  
**\$1,086.50 EA** ⚠



**C5CONVC** .....39-48  
Don't have a donor C5 Corvette? We've put together all the components for a front C5 Conversion in a kit. Complete with factory nuts/bolts to put it together. Includes factory GM aluminum A frame & uprights, disc brakes, motor mounts, custom power rack & pinion (rotates to clear mounts & headers), tubular crossmember for strength. No holes to drill, no welding, you can have corvette suspension, & V8 this afternoon! (LS adapters available). 57" track width. Must use min. 17" wheel with 4" Back Spacing. -0.15 ..... **CALL** ⚠  
**C5COMP** .....39-54

Don't have a donor C5 Corvette? We've put together all the components for a front C5 Conversion in a kit. Complete with factory nuts/bolts to put it together. Does not include crossmember, steering rack, shocks, springs. All new parts instead of used donor parts.

57" Track Width. Must use min. 17" wheel with 4" Back Spacing. -0.15 .....  
**\$2,699.50 EA** ⚠



**C5RACK** .....39-54  
Power steering rack required for C5 CONV IFS conversion. -0.15 .....  
**\$840.00 EA** ⚠

**C5 Corvette Suspension Conversion, cont.**



**C5CONV** .....49-54  
C5 Corvette Suspension Conversion. Bolt on front crossmember.

Fits 49-54 car & sedan delivery, also 1953-62 Corvette using your C5 suspension components. Requires C5RACK & C5SHOCKLMF. Must weld engine mounts. -0.15 .....  
**\$1,086.50 EA** ⚠

**C5CONVC** .....49-54  
Don't have a donor C5 Corvette? We've put together all the components for a front C5 Conversion in a kit. Complete with factory nuts/bolts to put it together. Includes factory GM aluminum A frame & uprights, disc brakes, motor mounts, custom power rack & pinion (rotates to clear mounts & headers), tubular crossmember for strength. No holes to drill, no welding, you can have corvette suspension, & V8 this afternoon! (LS adapters available). 57" track width. Must use min. 17" wheel with 4" Back Spacing. -0.15 ..... **CALL** ⚠



**C5SHOCKLMF** ....ALL  
Shock mounts on lower control arm, for C5 suspension 7.395 -0.15 .....  
**\$200.00 PR** ⚠

**IFS Mustang II Kit - Weld In**

Mustang II Suspension kits come complete with crossmember, paintable tubular upper and lower full A-frame style control arms, 11" five lug rotors, bearings and seals, springs, shocks, stock spindles, GM calipers with brackets and pads, manual rack and pinion with tie rod ends and bushings, rubber spring cushions, spindle nuts w/washers, and all mounting hardware.



**HEIDT'S IFS01** .....37-54  
Independent Front Suspension Kit. Heidt's weld in. Tubular A-arms with crossmember. 6.008 -0.15 .....  
**\$3,250.00 KIT** ⚠

**IFS Mustang II Kit - Weld In, cont.**

**HEIDT'S IFS02** .....37-54  
Independent front suspension kit Heidt's weld in. Tubular A-arms, without crossmember. 6.008 -0.15 .....  
**\$2,300.00 KIT** ⚠

**IFS Mustang II Crossmember - Weld In**

**CX102E** .....37-39  
CROSSMEMBER. MUSTANG II, HEIDT'S WELD IN, 37-39 CHEV CAR. 6.008-0 .....  
**\$535.00 EA** ⚠

**CX103E** .....40-48  
Heidt's Mustang II weld in crossmember. 1940-48 Chevy Cars. 6.008-0 .....  
**\$535.00 EA** ⚠

**CX104E** .....49-54  
CROSSMEMBER. MUSTANG II, HEIDT'S WELD IN, 49-54 CHEV CAR. 6.008-0 .....  
**\$535.00 EA** ⚠

**Dropped Uprights & Steering Arms**

**CDU3948** .....39-48  
1939-48 Chevy 2 1/2" dropped uprights for the original IFS, dropped steering arms CSA3948 required. Will accept original drum or aftermarket disc brakes. -0 .....  
**\$515.00 L&R** ⚠

**CSA3948** .....39-48  
1939-48 Chevy dropped steering arms for the original IFS required with the dropped uprights -0 .....  
**\$315.00 L&R** ⚠

**CDU4954** .....49-54  
1949-54 Chevy dropped uprights for the original IFS, 2 1/2" drop on '49-'52, 2" drop on '53-'54, dropped steering arms CSA4954 required. Will accept stock drum brakes or aftermarket disc brakes. -0 .....  
**\$515.00 L&R** ⚠

**CSA4954** .....49-54  
1949-54 Chevy dropped steering arms for the original IFS required with the dropped uprights -0 .....  
**\$315.00 L&R** ⚠

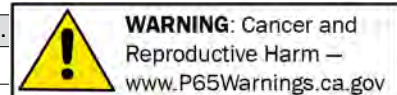

**SECTION 200C  
RESTORATION PARTS**

**Coil Springs**

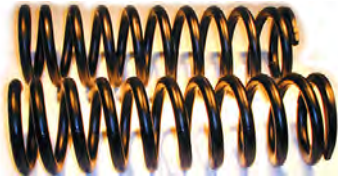

- 3694612** .....39-52  
Exc Powerglide & 49-52 Convertible  
6.361 -0.15 ..... **\$139.50 PR** ⚠
- 3664086** ..... 49-54  
Powerglide & 49-52 Convertible, all 53-54  
6.361 -0.15 ..... **\$135.25 PR** ⚠

**Front End Rebuild kit**



- FEK3948** .....39-48  
Deluxe kit for knee action includes:  
4 Outer Pin Kits  
Inner Shaft Kits Complete with Bushings  
2 Outer Tie Rod Ends  
1 King Pin Kit with Bushings  
2 Stabilizer Link Kits (as required)  
and more! -0.15 ..... **\$441.00 KIT** ⚠



actual parts may differ from image shown

- FEK4954** .....49-54  
Deluxe kit includes:  
4 Outer Pin Kits  
Inner Shaft Kits Complete with Bushings  
2 Outer Tie Rod Ends  
1 King Pin Kit with Bushings  
2 Stabilizer Link Kits (as required)  
Upper and lower bump stops  
and more!

(Does not include idler arm pivot pin repair kit 3696372) -0.15 ..... **\$506.00 KIT** ⚠

**Sway Bar-Front**



- 599593** .....32-38  
Car Front Sway Bar  
1" -0 ..... **\$229.00 EA** ⚠

- 599394** .....39-48  
Car Front Sway Bar 1" -0 ..... **\$295.00 EA** ⚠
- 3688966** .....49-50  
Car Front Sway Bar 1" -0 ..... **\$295.00 EA** ⚠

**Grease Fitting**



- 110347** .....ALL  
1/4 in. x 28 taper  
thread, 90 degree.  
8.984 -0.3 ..... **\$1.50 EA** ⚠



- 191758** .....ALL  
1/8 in. national pipe,  
straight. 8.984 -0.4  
..... **\$1.75 EA** ⚠

**A-Frame Link Pins**



- 603412** .....39-48  
Upper outer w/ seals 6.164 -0  
..... **\$63.75 EA** ⚠



- 3690683** .....39-54  
Lower outer w/ seals. Fits Pass & 53-62  
Corvette. 6.174 -0.15 ..... **\$67.25 EA** ⚠

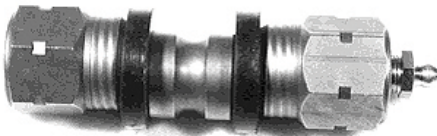

- 3690684** .....49-54  
Upper outer w/ seals. Fits Pass & 53-62  
Corvette. 6.164 -0.15 ..... **\$60.00 EA** ⚠

**Link Pin Seals**



- 599191** .....39-48  
Upper outer (4 pcs)  
6.166 -0.15 ..... **\$39.75 SET** ⚠



- 599199** .....39-54  
Lower outer & 53-62  
Corvette (4 pcs)  
6.166 -0.4 ..... **\$6.75 SET** ⚠



- 599180** .....49-54  
Upper outer & 53-62  
Corvette (4 pcs) 6.166 -0  
..... **\$20.25 SET** ⚠

**A-Frame Inner Shafts**



- 605003** .....39-48  
Lower A-frame, left, w/ seals 6.169 -0.15  
..... **\$120.00 EA** ⚠

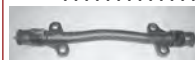

- 605004** .....39-48  
Lower A-frame, right, w/  
seals 6.169 -0.15  
..... **\$120.00 EA** ⚠



- 3693459** .....49-54  
Lower A-frame & 53-62 Corvette 6.169 -0.15  
..... **\$114.75 EA** ⚠



- 3693693** .....49-54  
Upper a-frame & 53-62 Corvette 6.164 -0.15  
..... **\$70.25 EA** ⚠

**A-Frame Inner Shaft Seals**



- 599180** .....39-54  
Upper or Lower A-frame  
& 53-62 Corvette (4  
pcs) 6.166 -0  
..... **\$20.25 SET** ⚠

**Axle Bumper**



- 593915** .....36-38  
Straight axle (2 pcs)  
7.422 -0.15  
..... **\$35.00 PR** ⚠



- 350251** .....39-40  
Front axle, KB & JB.  
Rebuild yours! 7.422 -0.15  
..... **\$136.75 PR** ⚠

**A-Frame Bumper**



- 3658602** .....39-41  
Lower A-frame, snap-in  
type 6.176 -0.15  
..... **\$30.00 PR** ⚠



- 1298323** .....39-54  
Upper A-frame also  
53-56 Corvette (2 pcs)  
6.176 -0.15  
..... **\$39.50 PR** ⚠

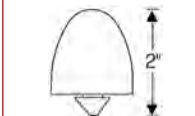

- 1298323E** .....39-54  
Upper A-frame also  
53-56 Corvette (2 pcs)  
6.176 -0.15  
..... **\$103.75 PR** ⚠



- 3687669** .....41-54  
Lower A-frame, bolt-in &  
53-62 Corvette. 2" high  
x 1.75" dia. 6.176 -0.15  
..... **\$46.75 PR** ⚠

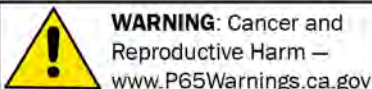

Chemicals shipped domestic ground only (Lower 48 states only). No international shipping.

**Phone: (360) 816-0211 • (800) 999-CHEV (2438) • www.chevsofthe40s.com**



**A-Frame Bumper, cont.**



**3687669E.....41-54**  
Lower A-frame, bolt-in & 53-62 Corvette. 2-3/4" height, 2" dia. 6.176 -0.15  
..... **\$62.25 EA** ⚠

**King Pins**



**602691.....29-36**  
Straight axle (exc CC, DC, EC & FC) 6.203 -0  
..... **\$59.00 PR** ⚠  
**603963.....34-38**  
Dubbonett independent suspension  
6.203 -0.15 ..... **\$146.75 PR** ⚠  
**602690.....37-40**  
Straight axle 6.203 -0.15 ... **\$80.00 PR** ⚠  
**599207.....39-54**  
Knee action & 53-62 Corvette 6.203 -0.15  
..... **\$104.25 PR** ⚠

**Dubbonett Seal Kit**



**592431B....34-38**  
Does 1 Dubbonett knee action shock  
6.400 -0  
..... **CALL** ⚠

**Dubbonett Rebuild Service**



**602499.....34-38**  
Suspension-rebuild yours 6.400 -0  
..... **\$800.00 EA** ⚠

**Shocks**

**5307484.....37-38**  
Exc GA & HA, left, 1201A (\$75 core)  
7.345 -0.15 ..... **\$200.50 EA** ⚠  
**5307485.....37-38**  
Exc GA & HA, right, 1201B (\$75 core)  
7.345 -0.15 ..... **\$200.50 EA** ⚠  
**5513851.....39-40**  
Front, JB & KB, beam axle. Replacement style (gas). 7.345 -0.15 .. **\$68.75 SET** ⚠

**Shocks, cont.**



**5352102.....39-48**  
Left, 2200A. Exc JB & KB, (\$150 core)  
6.162 -0.15 ..... **\$296.25 EA** ⚠



**5352103.....39-48**  
Right, 2200B Exc JB & KB (\$150 core)  
6.162 -0.15 ..... **\$296.25 EA** ⚠



**5531205.....49-54**  
Front 7.345 -0.15 ..... **\$87.25 PR** ⚠

**Shock Absorber Fluid**



**603489S.....ALL**  
Shock Absorber Fluid. 6.386 -0.15  
..... **\$12.00 QT** ⚠

**Shock Bracket**



**3688548.....49-54**  
Lower 7.380 -0.15  
..... **\$23.25 EA** ⚠

**Shock Bushing**



**041133.....30-38**  
Shock link, beam axle  
7.388 -0 .. **\$9.25 PR** ⚠



**\$16.00 PR** ⚠



**041133B.....30-38**  
Front Shock Link W/  
Brass Bushings, Pins &  
Cotter Keys, Beam Axle.  
Superior. 7.388 -0.15

**041153.....33-54**  
In Shock Arm (rubber)-  
double Action 7.377 -0  
..... **\$9.50 EA** ⚠

**Shock Bushing, cont.**



**043816.....33-55**  
Shock link double action shock. 7.388 -0.15  
..... **\$16.00 SET** ⚠



**3708378.....49-57**  
Rubber w/ washers & nuts. 7.388 -0.3  
..... **\$18.50 SET** ⚠

**Shock Link**



**043031A.....30-39**  
8in. overall, exc CC. 7.355 -0.4  
..... **\$20.00 EA** ⚠

**5302451A.....36-46**  
6-3/4in., FC, GB, HB w/ beam axle  
7.355 -0.3 ..... **\$20.00 EA** ⚠

**Spring Bolt Front Leaf**



**1288224.....ALL**  
Leaf spring center (exc  
utility vehicle) (2 pcs).  
7.506 -0.2 ..... **\$9.75 SET** ⚠

**U-bolt**



**601231.....34-40**  
W/ nuts, spring to axle  
exc EC & FC 7.417 -0.15  
..... **\$16.00 EA** ⚠

**Shackle Rebuild Kit**



**373199B.....34-54**  
Steel bushed, 4 pins, 4 bushings, 8 seals  
front or rear. 7.427 -0.15 .. **\$80.00 SET** ⚠

**Shackles Rubber Seals**



**593705.....34-54**  
Rubber for steel bushed  
shackles (8 pcs).  
7.443 -0.3 ..... **\$17.75 SET** ⚠

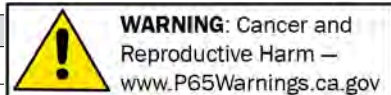

**Leaf Spring Teflon Liner**



**3699910T.....37-54**  
For leaf springs. 1-3/4" wide x 20 feet long. teflon 7.495 -0.15 ...

**\$75.50 SET** ⚠

**Sway Bar Bushing**



**350146.....39-40**  
Sway bar shaft cars w/ straight axle, use w/ #3501467 7.240 -0

**\$60.00 PR** ⚠



**3501467.....39-40**  
Sway bar shaft, straight axle, use 2 sets (2 piece set) 7.240 -0.15 ..... **\$17.50 SET** ⚠

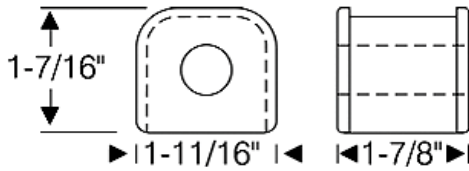

**599741.....39-40**

Sway bar to frame at end of sway bar shaft, rubber, on axle, JB & KB (2 pcs) 7.243 -0.15 ..... **\$105.25 PR** ⚠



**3708378.....39-54**

Rubber, for sway bar links (8) w/ washers & nuts, exc cars w/ straight axle 7.388 -0.3 ..... **\$18.50 SET** ⚠

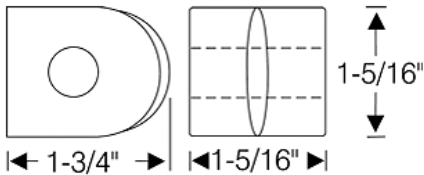

**599430.....39-54**

Sway bar shaft, exc straight axle (2 pcs) 7.243 -0.15 ..... **\$63.25 PR** ⚠

**Sway Bar Link Kit**

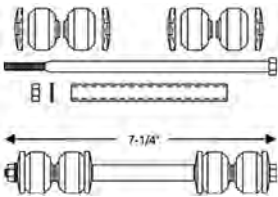

**599432.....39-54**

Exc cars w/ straight axle (2 pcs) 7.240 -0.2 ..... **\$18.25 SET** ⚠

**SECTION 210C STREET ROD PARTS**

Oversize shipping charges apply. Please call for rate.

**Rear Subframe For C5 Conversion**



**C5CONVR.....ALL**  
Rear subframe for C5 Corvette suspension and transaxle. Universal fit, weld in to any vehicle with a frame. Track width hub to hub is 66-3/8". Components not included. -0.15 ..... **\$2,350.00 EA** ⚠

**Lowering Blocks**

Lowering blocks are available with square or round u-bolts. Please specify when ordering.



**373201A.....37-54**  
1", w/ u-bolts. 7.427 -0.1 ..... **\$85.00 SET** ⚠

**373201B.....37-54**  
2", w/ u-bolts. 7.427 -0.15 .. **\$93.50 SET** ⚠

**373201C.....37-54**  
3", w/ u-bolts. 7.427 -0.15 . **\$115.00 SET** ⚠

**SECTION 210C RESTORATION PARTS**

**Sway Bar Rear**

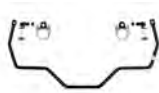

**599592.....32-38**  
Car Rear Sway Bar 3/4" -0 ..... **\$199.00 EA** ⚠

**599596.....39-48**  
Car Rear Sway Bar 3/4" -0 ..... **\$275.00 EA** ⚠

**Spring Rear Leaf**

For these leaf springs you will need to purchase the Bolt & Bushing Set #3690790 (listed after these springs). We press in the bushing free of charge.



**SPECIFY37.....36-37**  
Rear, 8 leaf. 7.503 -0 ..... **CALL** ⚠  
**SPECIFY53.....37-54**  
Rear, 7 leaf. 7.503 -0.15 ..... **CALL** ⚠  
**SPECIFY65.....37-54**

Use for open drive shaft. Also centers wheels in fenders. Can be made with arch to lower vehicle. Original springs will allow severe axle wrap w/ the torque tube removed. 7.503 -0 ..... **CALL** ⚠  
**SPECIFY54.....38-54**  
Rear, 8 leaf. 7.503 -0.15 ..... **CALL** ⚠

**Spring Bolt And Bushing**



**3690790.....34-54**  
For front mount of rear leaf spring. 7.504 -0.2 ..... **\$25.00 PR** ⚠

**Bushing Rear Spring Pivot**



**3652182A.....40-54**  
Bolt w/ nut, axle to spring pivot. 5.403 -0 ..... **\$27.25 PR** ⚠

**Spring Pivot Bolt Seals**

**597267.....38-54**  
Rear end to spring pivot bolt (4 ea). 5.404 -0.3 ..... **\$15.75 SET** ⚠

**Spring Leaves Plastic Insert**

**3699910.....53-54**  
Anti-squeak, between rear spring leaves, fits original springs (set of 12). 7.495 -0 .. **CALL** ⚠

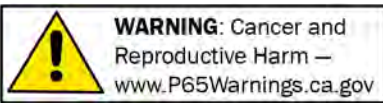

Chemicals shipped domestic ground only (Lower 48 states only). No international shipping.

Phone: (360) 816-0211 • (800) 999-CHEV (2438) • www.chevsofthe40s.com



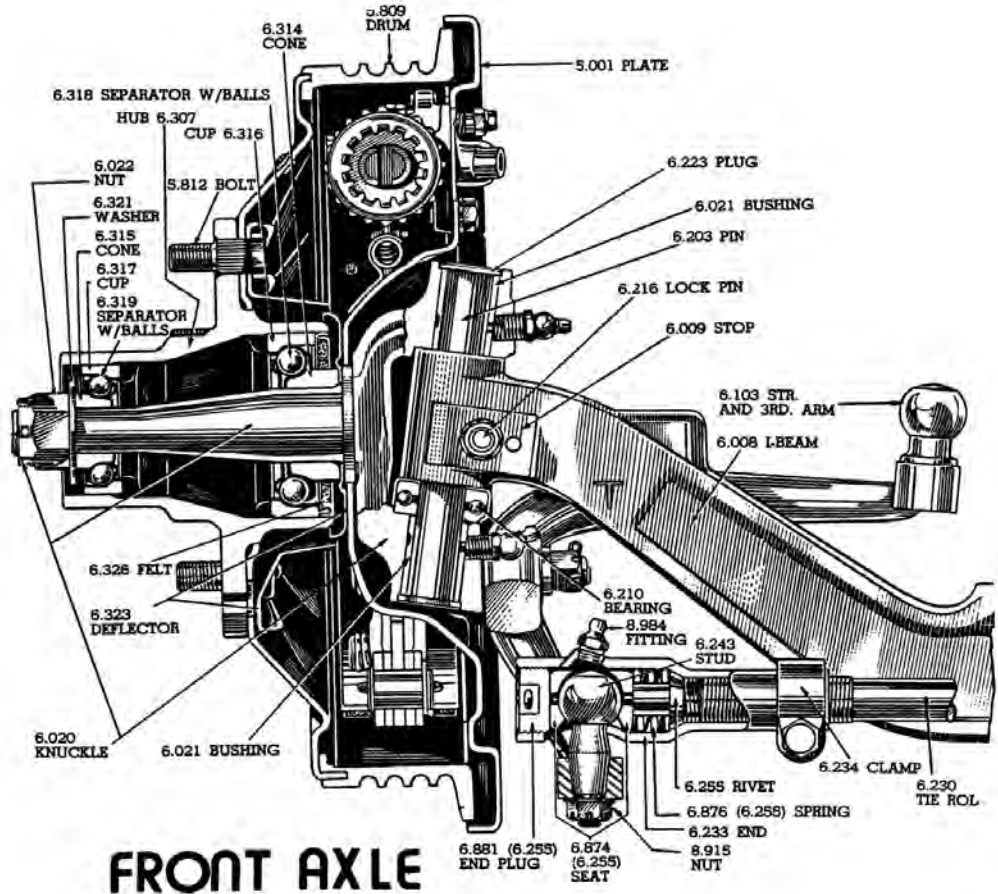

**ILLUSTRATIONS ARE COMPLETE ASSEMBLIES**

**FRONT AXLE**

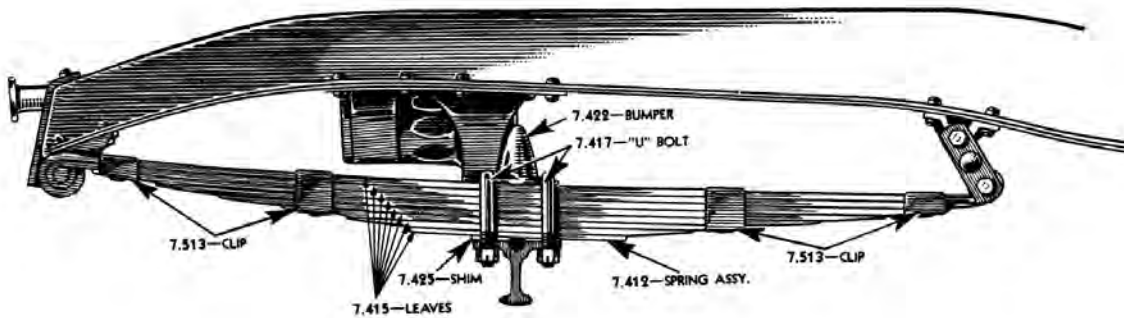

**FRONT SPRING AND PARTS**

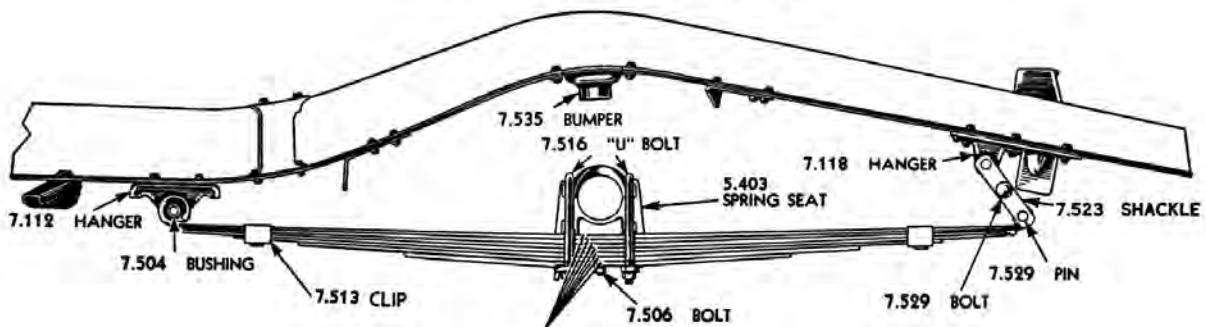

**REAR SPRING AND PARTS**

**Spring To Axle U-bolt**



**602509.....31-37**  
W/ nuts, spring to axle, fits 33-36 Sedan Delivery (exc CC, DC, EC, FC). 7.417 -0.15

**\$15.00 EA** ⚠️  
**601231.....38-54**  
W/ nuts, rear axle to spring pivot. 7.417 -0.15 **\$16.00 EA** ⚠️

**Leaf Spring Teflon Liner**



**3699910T.....37-54**  
For leaf springs. 1-3/4" wide x 20 feet long. teflon 7.495 -0.15

**\$75.50 SET** ⚠️

**Spring Center Bolt**



**1288224.....ALL**  
Leaf spring center (exc utility vehicle) (2 pcs).

7.506 -0.2 **\$9.75 SET** ⚠️

**Grease Fitting**



**110347.....ALL**  
1/4 in. x 28 taper thread, 90 degree. 8.984 -0.3 **\$1.50 EA** ⚠️



**191758.....ALL**  
1/8 in. national pipe, straight. 8.984 -0.4 **\$1.75 EA** ⚠️

**Shackles Rear**



**350441.....34-39**  
Exc DC & EC (Does 2). 7.523 -0 **\$105.00 SET** ⚠️



**604478.....40-54**  
Steel bushed (Does 2). 7.523 -0 **\$137.00 SET** ⚠️

**Shackles Rear, cont.**



**609462.....40-54**  
Rubber bushed (Does 2). 7.523 -0.15 **\$136.25 SET** ⚠️

**Shackle Rebuild Kit**



**373199B.....34-54**  
Steel bushed, 4 pins, 4 bushings, 8 seals front or rear. 7.427 -0.15 **\$80.00 SET** ⚠️

**Shackle Bushings**



**3660540.....40-54**  
Rubber (8 pcs). 7.524 -0.3 **\$18.75 SET** ⚠️

**Shackle Seals**



**593705.....34-54**  
Rubber for steel bushed shackles (8 pcs).

7.443 -0.3 **\$17.75 SET** ⚠️

**Axle Bumper Rear**



**365627.....29-33**  
This is rubber bumper or bumpstop for the rear axle. This prevents

the axle housing from bottoming out on the frame. 7.535 -0.15 **\$32.25 PR** ⚠️



**593915.....34-36**  
DA, EA, ED, FA, FD (2 pcs). 7.422 -0.15 **\$35.00 PR** ⚠️



**594149.....36-39**  
To frame (exc FA, FD). 7.535 -0.15

**\$211.75 PR** ⚠️

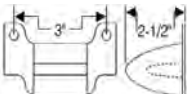

**3692555.....41-54**  
Car uses 2. 7.535 -0.15 **\$52.50 EA** ⚠️

**Shocks 1937-39**



**5307086.....37-39**  
Exc 39 JA, right, 1431V (\$75 core). 7.345 -0.15 **\$201.75 EA** ⚠️

**5307087.....37-39**  
Exc 39 JA, left, 1431W (\$75 core). 7.345 -0.15 **\$201.75 EA** ⚠️

**Shocks 1940**

**5342004.....40**  
KB only, right, 1201E (\$50 core). 7.345 -0.15 **\$175.00 EA** ⚠️

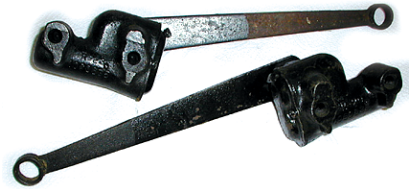

**5342004B.....40**  
KB only, 1201E, 1201F (\$100 pr core). 7.345 -0.15 **\$350.00 L&R** ⚠️

**5342005.....40**  
KB only, left, 1201F (\$50 core). 7.345 -0.15 **\$175.00 EA** ⚠️

**Shocks 1939-48**



**5352104.....39-48**  
Exc JB & KB, right, rear, 2100A (\$80 core). 7.345 -0.15 **\$249.75 EA** ⚠️

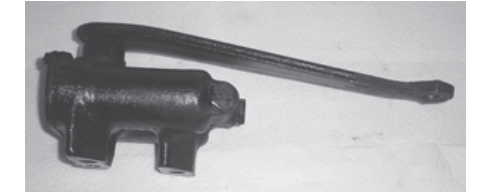

**5352105.....39-48**  
Exc JB & KB, left, rear, 2100B (\$80 core). 7.345 -0.15 **\$249.75 EA** ⚠️



**WARNING: Cancer and Reproductive Harm** — [www.P65Warnings.ca.gov](http://www.P65Warnings.ca.gov)

Chemicals shipped domestic ground only (Lower 48 states only). No international shipping.

Phone: (360) 816-0211 • (800) 999-CHEV (2438) • [www.chevsofthe40s.com](http://www.chevsofthe40s.com)



**Shocks 1949-54**



**5531210** ..... **.49-54**  
Rear (2 pcs). 7.345 -0.15 ... **\$110.75 PR**

**Shock Bushing**



**041153** ..... **.33-54**  
In Shock Arm (rubber)-  
double Action 7.377 -0  
..... **\$9.50 EA** ⚠



**3708378** ..... **.49-57**  
Rubber w/ washers & nuts. 7.388 -0.3  
**\$18.50 SET** ⚠

**Shock Link**



**1072240A** ..... **.38-40**  
7-5/32in. , HA & HB, 39 JB & 40 KB w/  
beam axle. 7.355 -0 ..... **CALL** ⚠



**5328600** ..... **.39-41**  
Assy (car W/ Front Knee Action) 7.355 -0  
..... **CALL** ⚠

**Shock Bushing Rubber**



**041133** ..... **.30-40**  
Shock link. Cars w/  
front beam axle. 7.388 -0  
..... **\$9.25 PR** ⚠



**041133B** ..... **.30-40**  
Shock link w/ brass  
bushings, pins & cotter  
keys. Fits cars w/ beam  
axle. Superior. 7.388 -0.15

..... **\$16.00 PR** ⚠



**043816** ..... **.33-55**  
Shock link double  
action shock. 7.388 -0.15

..... **\$16.00 SET** ⚠

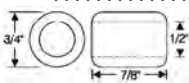

**5316364A** ..... **.39-48**  
Rubber shock link pin  
bushing (2 pack).

7.355 -0.15 ..... **\$29.75 PR** ⚠

**Shock Grommet**



**3708378A** ..... **.39-41**  
Shock link w/ nuts & washers. 7.388 -0.3  
..... **\$18.50 SET** ⚠

**Spring Bushing**



**011004** ..... **.ALL**  
Bushing for front mount  
of rear leaf spring. -0.2  
..... **\$9.00 EA** ⚠



**011004E** ..... **.ALL**  
Bushing for front mount  
of rear leaf spring. -0.15  
..... **\$75.00 EA** ⚠

**Odds And Ends**

Please call for availability on all Odds & Ends  
parts. Once part is sold, it may no longer be in  
stock.

**1054424U** ..... **.48-49**  
Shock rear left used 7.345 -0.4 **\$75.00 EA**  
⚠

**SECTION 220C  
STREET ROD PARTS**

**Custom Wheel Artillery (Bare)**



**AB** ..... **.ALL**  
Bare Steel Artillery  
Rim. 15" Only.  
Specify width and  
backspace. Available  
in 5,6,7,8,10,12,14  
inch widths. 5x4-  
3/4", 6x5-1/2"

Chevy or 5x4-1/2" Ford lug patterns. -0  
..... **starting at \$157.00 EA** ⚠

**Custom Wheel Artillery (Chrome)**



**AC** ..... **.ALL**  
All Chrome Artillery  
Rim. 15" Only.  
Specify size, width  
and backspace.  
Available in  
5,6,7,8,10,12,14  
inch widths. 5x4-

3/4", 6x5-1/2" Chevy or 5x4-1/2" Ford  
lug patterns. -0

..... **starting at \$239.00 EA** ⚠

**Custom Wheel Nostalgia (Bare)**



**NB** ..... **.ALL**  
Bare Steel Rim:  
14, 15 or 16" Rims  
Specify size, width  
and backspace.  
Available in  
5,6,7,8,10,12,14  
inch widths. 5x4-

3/4", 6x5-1/2" Chevy or 5x4-1/2" Ford  
lug patterns. -0

..... **starting at \$132.00 EA** ⚠

**Custom Wheel Nostalgia (Chrome  
Rim)**



**NCC** ..... **.ALL**  
Chrome rim, bare  
steel center. 14, 15  
or 16" Rims Specify  
size, width and  
backspace. Available  
in 5,6,7,8,10,12,14  
inch widths. 5x4-

3/4", 6x5-1/2" Chevy or 5x4-1/2" Ford  
lug patterns. -0

..... **starting at \$100.00 EA** ⚠

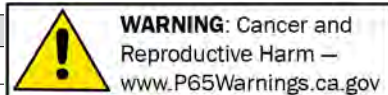

**Custom Wheel Nostalgia (Chrome)**



**NC.....ALL**  
All Chrome Rim.  
14, 15 or 16" Rims  
Specify size, width  
and backspace.  
Available in  
5,6,7,8,10,12,14  
inch widths. 5x4-  
3/4", 6x5-1/2" Chevy or 5x4-1/2" Ford  
lug patterns. -0  
.....starting at **\$105.00 EA** ⚠

**Custom Wheel Rally (Bare)**



**RB.....ALL**  
Rallye Bare Steel.  
14, 15 or 16" Rims  
Specify size, width  
and backspace.  
Available in  
5,6,7,8,10,12,14  
inch widths. 5x4-  
3/4", 6x5-1/2" Chevy or 5x4-1/2" Ford  
lug patterns. -0  
.....starting at **\$88.00 EA** ⚠

**Custom Wheel Rally (Chrome Rim)**



**RCC.....ALL**  
Chrome rim with  
bare steel center.  
14, 15 or 16" Rims  
Specify size, width  
and backspace.  
Available in  
5,6,7,8,10,12,14  
inch widths. 5x4-  
3/4", 6x5-1/2" Chevy or 5x4-1/2" Ford  
lug patterns. -0  
.....**CALL** ⚠

**Custom Wheel Rally (Chrome)**



**RC.....ALL**  
All Chrome Rim:  
14, 15 or 16" Rims  
Specify size, width  
and backspace.  
Available in  
5,6,7,8,10,12,14  
inch widths. 5x4-  
3/4", 6x5-1/2" Chevy or 5x4-1/2" Ford  
lug patterns. -0  
.....starting at **\$116.00 EA** ⚠

**Hub Caps Modified For Artillery / Nostalgia**



**594453M ...37-38**  
Modified for artillery  
/ nostalgia wheel  
5.858 -0.15  
..... **\$125.00 EA** ⚠

**Hub Caps Modified For Artillery / Nostalgia, cont.**

**594453MS.....37-38**  
Stainless. Modified for artillery / nostalgia  
wheel. 5.858 -0.15 ..... **\$124.75 EA** ⚠



**599748MS .... 39**  
Stainless. Modified  
to fit artillery /  
nostalgia wheel.  
5.858 -0.15  
..... **\$124.75 EA** ⚠



**654307M ..... 40**  
Chrome. Modified  
to fit artillery /  
nostalgia wheel.  
5.858 -0.15  
..... **\$124.75 EA** ⚠

**3658374MS.....41-48**  
Stainless 1941-48 Passenger (41-46  
Commercial exc. 46 1Ton) For artillery /  
nostalgia wheels 5.858 -0.2 ..... **\$102.25 EA**  
⚠



**3687976M .... 49**  
Red center, blue  
Bow-tie. Modified  
to fit artillery /  
nostalgia wheel.  
5.858 -0.15  
..... **\$99.00 EA** ⚠



**3908671.....ALL**  
Police, plain. Fits  
artillery / nostalgia  
wheel. 5.858 -0  
..... **CALL** ⚠

**MODIFY.....ALL**  
Modify your hub cap to fit custom artillery  
/ nostalgia or rally wheel 5.858 -0.15 ..  
**\$75.00 EA** ⚠

**Hub Caps Modified For Rallye**



**594453MRS .37-38**  
Stainless. Modified  
for rallye wheel.  
5.858 -0.15  
..... **CALL** ⚠

**Hub Caps Modified For Rallye, cont.**



**599748MR..... 39**  
Chrome. Modified to fit rallye wheel.  
5.858 -0 ..... **CALL** ⚠  
**599748MRS..... 39**  
Stainless. Modified to fit rallye wheel.  
5.858 -0.15 ..... **\$85.00 EA** ⚠



**654307MR .... 40**  
Chrome. Modified  
to fit rallye wheel.  
5.858 -0.15  
..... **\$148.75 EA** ⚠



**3658374MR .41-48**  
1941-48 Passenger  
(41-46 Commercial  
exc 46 1Ton)  
Modified to fit rallye  
wheel. 5.858 -0.15  
..... **\$99.00 EA** ⚠



**3908672.....ALL**  
Police, plain. Fits  
rallye wheel. 5.858 -0  
..... **CALL** ⚠

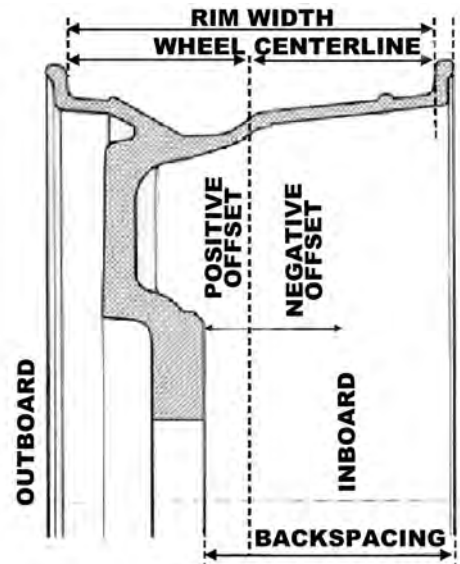

**WARNING:** Cancer and  
Reproductive Harm —  
www.P65Warnings.ca.gov

Chemicals shipped domestic ground only (Lower 48 states only). No international shipping.

Phone: (360) 816-0211 • (800) 999-CHEV (2438) • www.chevsofthe40s.com



# Section 220C: Wheels, Hub Caps, Beauty Rims, Tires & Wheel Bearings

## Hub Caps Modified For Rallye, cont.



**3908673** .....ALL  
Police w/ bowtie. Fits rallye wheel 5.858 -0.2  
..... **\$50.00 EA** ⚠

## Hub Caps Custom



**3705092M** .....37-48  
Baby moon, 37-48 Cars.  
37-46 1/2Ton & 37-41  
3/4Ton. 5.858 -0.15

**\$202.50 SET** ⚠  
**3705092MM** .....37-59  
Baby moon, 37-46  
1/2Ton & 37-41  
3/4Ton, modified to fit  
nostalgia wheel

5.858 -0.15 ..... **\$45.00 EA** ⚠



**3705092N** .....ALL  
14 in. Nude Figure.  
Chrome. 5.858 -0.15

..... **\$335.00 SET** ⚠



**3705092Z** .....ALL  
15 in. nomad style.  
chrome -0

**\$136.00 EA** ⚠  
**HCAPCADDY16** .....ALL  
16" Cadillac  
Sombrero -0.15



**\$230.00 SET** ⚠  
**HCAPCROSS14** .....ALL  
14 inch Crossbar style.  
5.858 -0.15



**\$300.00 SET** ⚠  
**HCAPCROSS15** ..... ALL  
15 inch Crossbar style. 5.858 -0

..... **CALL** ⚠



**HCAPLANCER** .....ALL  
15 inch 59 Lancer style.  
5.858 -0.15

**\$550.00 SET** ⚠  
**HCAPLANCERB14** .ALL  
14 inch 57 Lancer style.  
5.858 -0.15



**\$249.00 SET** ⚠  
**HCAPLANCERB15** ..... ALL  
15 inch 57 Lancer style. 5.858 -0.15

..... **\$269.75 SET** ⚠



**HCAPPOLARA15** .ALL  
15" Polara Style custom  
hub caps(set of 4)  
5.858 -0.15

..... **\$306.25 SET** ⚠

## Hub Caps Custom, cont.



**HCAPSOMBRERO16** ..  
ALL  
Wheel Covers Bullet  
Sombrero Style 16" - Set  
of 4 -0.15

**\$235.00 SET** ⚠

## Wheel Cover



**HCAPSBURST14** .ALL  
14 inch Starburst Style  
5.858 -0.15

**\$105.25 SET** ⚠  
**HCAPSBURST15** .ALL  
15 inch Starburst Style  
5.858 -0.15



**\$88.25 SET** ⚠  
**Nude Lady**  
**3705092H** .....ALL  
3 dimensional nude  
figure handle or hubcap  
ornament. Chrome,  
12-1/4 in. length.

5.858 -0.15 ..... **\$59.75 EA** ⚠

## SECTION 220C RESTORATION PARTS

### Hub Caps Stock



**594453S** .....37-38  
Stainless 5.858 -0



**\$73.25 EA** ⚠  
**599748S** ..... 39  
Stainless 5.858 -0



**\$70.00 EA** ⚠  
**654307** ..... 40  
Chrome 5.858 -0

**CALL** ⚠  
**654307S** ..... 40  
Stainless 5.858 -0

**\$70.00 EA** ⚠  
**3658374S** .....41-48  
Stainless 1941-48 Passenger (41-46  
Commercial exc. 46 1Ton) 5.858 -0.15



**\$62.75 EA** ⚠  
**3687976** ..... 49  
Red center, blue  
Bow-tie. 5.858 -0.15

**\$60.75 EA** ⚠  
**3687976S** ..... 49  
Red center, blue Bow-tie. Stainless  
5.858 -0.15



**\$63.00 EA** ⚠  
**3694318** ..... 50  
W/ gold center  
5.858 -0.15

..... **\$63.50 EA** ⚠

## Hub Caps Stock, cont.



**3969493** .....51-53  
This is superb  
reproduction of a  
1951-53 hubcap with a  
blue bow-tie in the  
center. 5.858 -0.15

..... **\$66.00 EA** ⚠  
**3707030** ..... 54  
Hub cap 5.858 -0.15  
..... **\$66.00 EA** ⚠

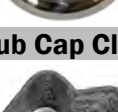

**Hub Cap Clip Retaining**  
**3704844** .....39-53  
Retaining clip. Fits  
39-53 Pass (w/ 15in  
wheels) & 39-58 1/2T  
truck (w/ 16in wheels). 5.864 -0.15

..... **\$2.50 EA** ⚠

## Beauty Rings



**986906** .....54-55  
Convex, original, 210 &  
150 series 5.858 -0  
..... **CALL** ⚠



**1279680** .....ALL  
Ribbed 16 in. (outer wheel). 5.858 -0.15  
..... **\$37.75 EA** ⚠

**1279680S** ..... ALL  
Smooth 16 in. (outer wheel). 5.858 -0.15  
..... **\$49.75 EA** ⚠

**986214** ..... ALL  
14in. (outer wheel). 5.858 -0.15

**\$28.00 EA** ⚠  
**986259** ..... ALL  
Ribbed 15 in. (outer wheel). 5.858 -0.15

**\$36.25 EA** ⚠  
**986259S** ..... ALL  
Smooth 15 in. (outer wheel). 5.858 -0.15  
..... **\$32.00 EA** ⚠

## Wheel Discs



**985542** ..... 40  
Original Accessory, Shark Tooth Rings, Set  
of 4. For 16 inch wheels. 5.858 -0  
..... **CALL** ⚠

Returns require a return authorization number—call first. • Product pricing & availability subject to change.

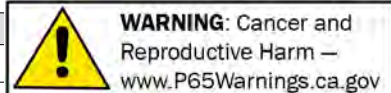

**Wheel Discs, cont.**



**1279681..... 41**  
Ribbed original accessory, inner wheel disc between cap and outer ring, set of 4. For

16" Wheels 5.858 -0 ..... **CALL** ⚠️

**Wheel Cover Medallion**



**3708310..... 54**  
For wheel cover (plastic) 5.858 -0.15 ..... **\$16.50 EA** ⚠️

**3708310B..... 54**  
For wheel cover (plastic) (set of 4) 5.858 -0.15 ..... **\$56.00 SET** ⚠️

**Tire Care**



**91800.....ALL**  
Wide White has been developed specifically to aid in restoring and beautifying wide whitewall tires. This cleaner is safe to use on white rubber and is made from

environmentally friendly ingredients. Restore your sidewalls to snowy white luster. -0

..... **\$15.00 EA** ⚠️

**Tire White Wall Radial**

Oversize shipping charges apply. Please call for rate.

Note: All tires must be inflated to manufacturers recommended PSI.



**368981R.....ALL**  
(670x15) Coker classic. 2-3/8 in. white wall 5.804 -0 ..... **\$312.00 EA** ⚠️

**3693215R..... ALL**  
(650x16) Diamond Back Classics 3-1/2 in. white wall. Tubeless. 5.804 -0 ..... **\$325.00 EA** ⚠️



**3693215RC...ALL**  
(650x16) Coker Classic 3-1/4 in. white wall. 5.804 -0 ..... **\$442.00 EA** ⚠️

**Tire White Wall Bias Ply**

**368981..... ALL**  
(670x15) Coker, BF Goodrich 3-5/8 in. white wall tubeless 5.804 -0 ..... **\$282.00 EA** ⚠️

**3693215..... ALL**  
(650x16) Coker, BF Goodrich 3-3/4 in. white wall 5.804 -0 ..... **\$300.00 EA** ⚠️

**3693215F..... ALL**  
(650x16) Coker, Firestone 3-1/4 in. white wall. 5.804 -0 ..... **\$346.00 EA** ⚠️



**599886.....ALL**  
(600x16) BF Goodrich 3-1/2 in. white wall. Made from original molds.

5.804 -0 ..... **\$318.25 EA** ⚠️

**Tire Black Wall Radial**



**599887R.....ALL**  
(600x16) Coker, BF Goodrich. Made from original molds. 5.804 -0.15 .....

**\$330.00 EA** ⚠️

**Tire Black Wall Bias Ply**

**368981B.....ALL**  
(670x15) Coker, BF Goodrich. Tubeless. 5.804 -0

..... **\$202.00 EA** ⚠️

**3693215B..... ALL**  
(650x16) Coker, BF Goodrich. 5.804 -0 .. **\$211.50 EA** ⚠️



**599887.....ALL**  
(600x16) BF Goodrich. 4 ply. Made from original moulds. 5.804 -0.15 ..... **\$280.75 EA** ⚠️

**Tube**



**599885.....ALL**  
600-650 x 16 5.804 -0 ..... **\$28.00 EA** ⚠️

**Valve Stem Cap**

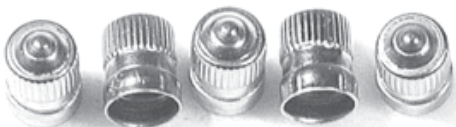

**599884.....ALL**  
Original metal style (5 pcs) 5.804 -0.4 ..... **\$5.00 SET** ⚠️



**CROWNCAPGD...ALL**  
Crown cap. Gold plastic (5 pcs). 5.804 -0 ..... **\$9.50 SET** ⚠️

**Valve Stem Cap, cont.**



**CROWNCAPR.....ALL**  
Crown cap. Red plastic (5 pcs). 5.804 -0.15 ..... **\$6.25 SET** ⚠️



**VC69978.....ALL**  
Chrome Large 8 Ball Valve Cap -0.2 ..... **\$11.00 SET** ⚠️



**VC69981.....ALL**  
Chrome Dice Valve Caps -0 ..... **CALL** ⚠️



**VC70004.....ALL**  
Skull Valve Caps -0.15 ..... **\$7.25 SET** ⚠️



**VC70005.....ALL**  
Dice Valve Caps-Red With White Dots -0.15 ..... **\$5.00 SET** ⚠️



**VC70006.....ALL**  
Dice Valve Caps-White With Black Dots -0.15 ..... **\$5.00 SET** ⚠️



**VC70007.....ALL**  
Dice Valve Caps-Black With White Dots -0.15 ..... **\$5.00 SET** ⚠️



**VC70008.....ALL**  
Dice Valve Caps- Blue With White Dots -0.15 ..... **\$5.00 SET** ⚠️



**VC70022.....ALL**  
8 Ball Valve Caps -0.15 ..... **\$5.00 SET** ⚠️



**VC70038.....ALL**  
Chrome Spike Valve Caps -0.15 ..... **\$8.75 SET** ⚠️

**Tinnerman Nuts**



**365897.....ALL**  
Retains rear brake drum (6 pcs). 5.810 -0 ..... **\$7.50 SET** ⚠️

**Lug Nut**



**358501.....29-57**  
Pass Car, 1/2Ton & 29-42 3/4Ton & 1Ton 5.813 -0.2 ..... **\$0.75 EA** ⚠️

**Stud For Lug Nut**



**370465.....30-40**  
Front exc FA, GA, HA, JA, KA, KH 5.812 -0.15 ..... **\$3.75 EA** ⚠️



**375696.....36-54**  
Rear 5.812 -0.15 ..... **\$3.00 EA** ⚠️

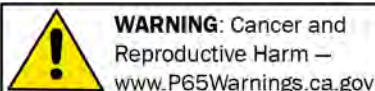

**WARNING: Cancer and Reproductive Harm** — www.P65Warnings.ca.gov

Chemicals shipped domestic ground only (Lower 48 states only). No international shipping.

**Phone: (360) 816-0211 • (800) 999-CHEV (2438) • www.chevsofthe40s.com**



# Section 220C: Wheels, Hub Caps, Beauty Rims, Tires & Wheel Bearings

## Stud For Lug Nut, cont.

 **476515** ..... **36-54**  
Front exc FD, FC, GB,  
HB, JB 5.812 -0.3 .....  
**\$2.25 EA** ⚠

## Dust Cover

 **370262** ..... **33-54**  
Front wheel bearing  
dust cover (metal)  
5.858 -0.15 .....  
**\$13.00 PR** ⚠

## Spindle Nut And Washer

 **378137** ..... **40-67**  
Front wheel 6.022 -0.15  
..... **\$8.50 SET** ⚠

## Wheel Bearing



**909002** ..... **29-40**  
Inner. Front wheel. Fits Pass, 1/2Ton,  
3/4Ton & 1 Ton (except standard and light  
duty) 6.311 -0.2 ..... **\$41.00 EA** ⚠  
**909001** ..... **29-57**  
Outer. Front wheel. Fits Pass and 1/2Ton  
& 29-42 3/4Ton (Exc. 33-36 Standard  
CC-DC-EC-FC) 6.313 -0.2 ..... **\$43.75 EA** ⚠  
**909052** ..... **41-54**  
Inner. Front wheel 6.311 -0.4 ..... **\$85.00 EA**  
⚠

## Wheel Bearing Roller





**909002R** ..... **29-40**  
ROLLER replacement. Inner, front. PASS &  
1/2Ton & 3/4Ton. 6.311 -0 ..... **CALL** ⚠  
**909001R** ..... **29-57**  
ROLLER replacement. Outer. Fits Pass &  
1/2Ton & 29-42 3/4Ton 6.313 -0.15 .....  
**\$50.00 EA** ⚠  
**909052R** ..... **41-54**  
ROLLER replacement. Inner. Front wheel  
6.311 -0.3 ..... **\$72.75 EA** ⚠

## Wheel Bearing Roller Conversion



**BEARINGKIT** ..... **41-54**  
Convert your ball bearings to roller. For  
both sides of front end. 6.311 -0.2 .....  
**\$260.00 SET** ⚠

## Wheel Bearing Seal Front

 **352488** ..... **29-40**  
Cars & 1/2Ton trucks.  
6.326 -0.3 .....  
**\$45.75 EA** ⚠  
 **3656536** ..... **41-54**  
This is the front wheel  
bearing seal that fits  
into the hub on the  
spindle. 2-15/16" O.D.  
6.326 -0.15 ..... **\$14.00 EA** ⚠  
**3687629** ..... **49-54**  
Front hub deflector.  
6.326 -0 ..... **CALL** ⚠

## Odds And Ends

Please call for availability on all Odds & Ends  
parts. Once part is sold, it may no longer be in  
stock.  
**370957** ..... **29-38**  
Oil Deflector, Front Hub, Straight  
14.000 -0.4 ..... **\$6.00 EA** ⚠  
**909021N** ..... **33-36**  
Bearing front outer (NOS) 6.313 -0 .....  
**\$30.00 EA** ⚠  
**985705** ..... **41-42**  
Wheel discs w/o ribs. Needs rechromed  
16.000 -0.4 ..... **\$150.00 EA** ⚠  
**986108N** ..... **47-48**  
Accy. Tire Tracks to get out of snow and  
sand. -0.4 ..... **\$100.00 SET** ⚠  
**12380** ..... **48**  
Accy. Wheel Covers, 16in. (Used)  
16.000 -0.4 ..... **\$65.00 EA** ⚠  
**986358U** ..... **49-50**  
Accy. Wheel Cover (Used) 16.000 -0.4 .....  
**\$65.00 EA** ⚠  
**3698352U** ..... **52**  
Wheel cover (Used). Very rare. Stainless,  
blue center w/ Bowtie. 5.858 -0.4 .....  
**\$65.00 EA** ⚠  
**3708308U** ..... **54**  
Wheel Cover, Stainless. Center Piece  
missing. Good Condition (Used) 5.858 -0.4  
..... **\$100.00 EA** ⚠  
**3739109** ..... **55-56**  
Rear wheel bearing fits 57 passenger &  
corvette 5.855 -0.4 ..... **\$45.00 EA** ⚠  
**909040** ..... **55-57**  
Front wheel inner bearing 5.855 -0.4 .....  
**\$35.00 EA** ⚠  
**909070** ..... **58-63**  
Front wheel bearing, inner 6.311 -0.4 .....  
**\$30.00 EA** ⚠

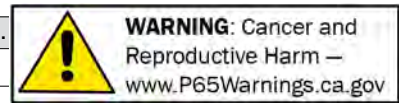

**Section 230C: Bumpers, Bumper Brackets, Splash Aprons, License Brackets, License Frames & Continental Kits**

**SECTION 230C  
STREET ROD PARTS**

**Bumpers Briz**

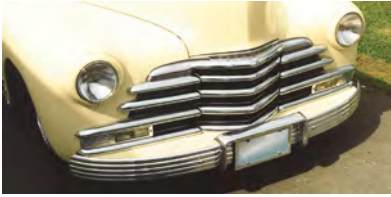

**BRIZ5RIB** .....**35-54**  
Original 5 rib, fully polished (front and rear) alloy bumper. Fits 35-48 Chevy cars, 37+54 Chevy trucks. 4-1/2 in. face. Mount Front or Rear. 7.831 -0.15

**\$415.75 EA** ⚠

**BRIZ3RIB** .....**ALL**  
3 rib, fully polished (on both sides) alloy bumper. Fits 28-40

Chevy cars. 2-7/8 in. face. 7.831 -0.15

**\$415.75 EA** ⚠



**BRIZ5RIB-SH** .....**ALL**  
Original 5 rib polished alloy bumper. Fits 49-53 Chevy cars, 41-54 Chevy trucks. 4-1/2 in. face. 7.831 -0.15

**\$446.75 EA** ⚠



**BRIZBOLT** .....**ALL**  
Polished, Stainless bumper bolt. Radiused head to fit over ribs. -0.15

**\$14.75 EA** ⚠

**Bumper Briz License Guard**



**BRIZGUARD** .....**ALL**  
Polished. '49 Chevy style. -0

**\$198.50 EA** ⚠

**License Plate Mounting Bracket Briz**



**BRIZBRKT** .....**ALL**  
License plate mounting bracket for BRIZ license guard. -0.4 ... **\$22.00 EA** ⚠

**Bumper Brackets Alloy**

Call for your specific application for Aluminum Bumper Brackets

**BRACKETCRP** .....**ALL**  
Polished, "C" style, rear. -0 **CALL** ⚠



**BRACKETJFP** .....**ALL**  
Polished, "J" style front. Call for your specific application. Fits BRIZ & other bumpers for most 37-54 Chevy trucks, 28-32 (some 33-36 & 46-57) Ford cars & most 28-56 Ford trucks. -0.15 **CALL** ⚠

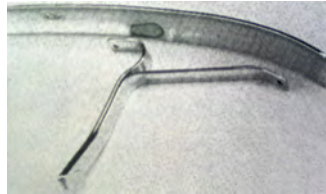

**BRACKETYFP** .....**ALL**  
Polished, "Y" style front. Call for your specific application. Fits BRIZ & other bumpers for 37-48 (some 35-36) Chevy cars, some 37-54 Chevy trucks, 37-41 (some 33-36) Ford cars & some 33-41 Ford trucks. -0 **CALL** ⚠

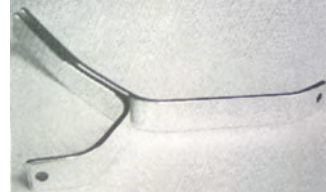

**BRACKETYRP** .....**ALL**  
Polished, "Y" style rear. Call for your specific application. Fits BRIZ & other bumpers for 37-48 Chevy cars, some 37-54 Chevy trucks, 37-41 Ford cars & some 33-41 Ford trucks. -0 **CALL** ⚠

**Bumper Brackets Alloy, cont.**



**BRACKETYSFP** .....**ALL**  
Polished, "Y" style "Shoobox" front. Call for your specific application. Fits BRIZ & other bumpers for most 49-53 Chevy cars & most 46-57 Ford cars. -0 **CALL** ⚠

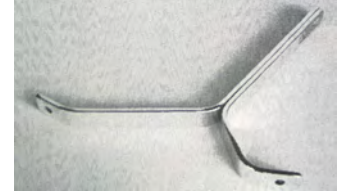

**BRACKETYSRP** .....**ALL**  
Polished, "Y" style "Shoobox" rear. Call for your specific application. Fits BRIZ & other bumpers for most 49-53 Chevy cars & most 46-57 Ford cars. -0 **CALL** ⚠

**SECTION 230C  
RESTORATION PARTS**

**Continental Kit**

Oversize shipping charges apply. Please call for rate.



**987265C** .....**49-50**  
Complete kit w/ full face cover & chrome tread cover. 7.629 -0.15 **\$1,935.00 KIT** ⚠



**987265D** .....**51-52**  
Complete kit w/ full face cover & chrome tread cover. 7.629 -0.15 **\$1,935.00 KIT** ⚠

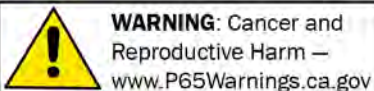

Chemicals shipped domestic ground only (Lower 48 states only). No international shipping.

**Phone: (360) 816-0211 • (800) 999-CHEV (2438) • www.chevsofthe40s.com**



# Section 230C: Bumpers, Bumper Brackets, Splash Aprons, License Brackets, License Frames & Continental Kits

## Continental Kit, cont.



**987265.....53-54**  
Complete kit w/ full face cover & chrome  
tread cover. 7.629 -0.15 **\$2,098.00 KIT**  
⚠️

## Bumpers Polished Stainless



**594528.....37**  
Polished Stainless. Front or rear. Fits  
Master Deluxe. No holes. Studs for  
brackets welded to back. 7.831 -0.15  
..... **\$525.75 EA** ⚠️



**594648S .....37**  
Polished Stainless. Fits on Master front &  
Front or Rear on trucks. 7.831 -0.15  
**\$525.00 EA** ⚠️



**3847305S .....38-39**  
Polished Stainless. Front or Rear.  
No holes. Studs for brackets welded to  
back. 7.831 -0.15 ... **\$558.50 EA** ⚠️



**3653339S .....40**  
Polished Stainless. No holes. Studs for  
brackets welded to back. Fits front or rear  
(exc. rear of Wagon & Sedan Delivery).  
16.400 -0.15 ..... **\$525.75 EA** ⚠️

## Bumpers Triple Plated Chrome

Oversized shipping charges apply. Please call  
for rate.



**594648.....37**  
Copper-Nickel-Chrome. Fits on Master  
front & Front or Rear on trucks. 7.831 -0.12  
..... **\$476.00 EA** ⚠️

## Bumpers Triple Plated Chrome, cont.



**3847305.....38-39**  
Copper-Nickel-Chrome. Front or Rear.  
7.831 -0.15 ..... **\$523.75 EA** ⚠️



**3653339 .....40**  
Copper-Nickel-Chrome. Fits front or rear  
(exc. rear of Wagon & Sedan Delivery).  
7.831 -0.15 ..... **\$476.00 EA** ⚠️

## Bumpers Nickel Chrome One Piece



**3681219 .....46-48**  
Front Chrome -0.15 **\$362.50 EA** ⚠️



**3681220 .....46-48**  
Rear Chrome (Exc. Wag. & Sed. Del.) -0.15  
..... **\$362.50 EA** ⚠️



**3698600 .....49-52**  
Nickel-Chrome Front, 1-piece. 7.831 -0.15  
..... **\$408.75 EA** ⚠️



**3698604 .....49-52**  
Nickel-Chrome Rear, 1-piece. 7.831 -0.15  
..... **\$408.75 EA** ⚠️



**3697341.....53**  
Nickel-Chrome Front, 1-piece. Has bumper  
bolt holes and license plate mount holes.  
7.831 -0.15 ..... **\$406.00 EA** ⚠️

## Bumpers Nickel Chrome One Piece, cont.



**3697689.....53-54**  
Nickel-Chrome Rear, 1-piece w/ bumper  
bolt holes. Passenger cars (exc Sedan  
delivery & Wagon). 7.831 -0.15 .....  
**\$406.00 EA** ⚠️



**3704531.....54**  
Nickel-Chrome Front, 1-piece. Has bumper  
bolt holes and license plate mount holes.  
7.831 -0.15 ..... **\$406.00 EA** ⚠️

## Fender Guard



**609499.....46-48**  
Front, left side. Includes  
hardware. 7.827 -0.15  
..... **\$196.25 EA** ⚠️



**609500.....46-48**  
Front, right side.  
Includes hardware.  
7.827 -0.15 .....  
**\$196.25 EA** ⚠️



**609507.....46-48**  
Rear, left side. Includes  
hardware. 7.827 -0.15  
..... **\$196.25 EA** ⚠️



**609508.....46-48**  
Rear, right side.  
Includes hardware.  
7.827 -0.15 .....  
**\$180.50 EA** ⚠️

## License Guard



**3690351.....49**  
Front, center license  
plate guard. Chrome  
7.799 -0.15 .....  
**\$204.25 EA** ⚠️

## Bumper Center Guard



**596319.....38-39**  
Grille guard, original  
accessory, no frame  
brace. 7.828 -0 .....  
**CALL** ⚠️



**985456A.....38-39**  
Trunk, fold down w/  
latch, no brace. 7.828 -0  
..... **CALL** ⚠️

Returns require a return authorization number—call first. • Product pricing & availability subject to change.

142 Phone: (360) 816-0211 • (800) 999-CHEV (2438) • www.chevsofthe40s.com

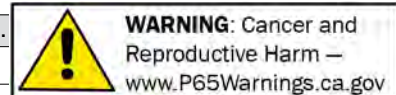

# Section 230C: Bumpers, Bumper Brackets, Splash Aprons, License Brackets, License Frames & Continental Kits

## Bumper Center Guard, cont.

- 985979SL** ..... **46-48**  
 Accy. Fold Down Trunk Guard Spring Large  
 17000.000-0 ..... **\$75.00 EA** ⚠️  
**985979SM** ..... **46-48**  
 Accy. Fold Down Trunk Guard Spring Small  
 17000.000-0 ..... **\$75.00 EA** ⚠️

## Bumper Guards

- 597827** ..... **38-39**  
 Front or rear bumper.  
 Fits left or right.  
 7.828-0.15 .....  
**\$227.50 EA** ⚠️  
**3681917** ..... **46-48**  
 Front or rear bumper.  
 7.828-0.15 ..... **CALL** ⚠️

## Bumper Guard Bolt

- 597825A** ..... **37**  
 1-1/8in. x 2-1/2in. With  
 nut and lock washer  
 7.829-0.15 .....  
**\$35.00 EA** ⚠️  
**597825** ..... **38-39**  
 1-3/8in. x 2-1/2in.  
 7.829-0.15 .....  
**\$13.00 EA** ⚠️  
**604602** ..... **39-48**  
 Steel plate w/ bolt &  
 nut for fold down rear  
 guard brace, goes  
 above crossmember.  
 7.830-0.15 ..... **\$57.25 EA** ⚠️  
**3681917B** ..... **46-48**  
 Used to fill hole if not  
 using bumper guard.  
 15/16"x2" 1/2-13  
 7.828-0 ..... **\$20.25 PR** ⚠️

## Bumper Assembly Kit Rear

- 3695907B** ..... **41-54**  
 Rear bumper assembly  
 kit includes bolts, finish  
 nuts, washers & screws.  
 7.874-0 ..... **CALL** ⚠️  
**3695907CC** ..... **41-54**  
 Rear bumper assembly kit includes  
 Chrome bolts, finish nuts, washers &  
 screws. 7.874-0 ..... **\$30.00 SET** ⚠️

## Bumper Bolt

- 594206** ..... **37-40**  
 Oval head bolt, finish  
 nut & lock washers.  
 7.874-0.15 ..... **\$8.00 EA** ⚠️  
**3695906** ..... **41-54**  
 Standard bolt, marsden  
 nut, flat & lock  
 washers, as original.  
 7.874-0 ..... **CALL** ⚠️

## Bumper Bolt, cont.

- 3695907** ..... **41-54**  
 Stainless cap bolt,  
 finish nut & washers as  
 original. 7.874-0 .....  
**CALL** ⚠️  
**3695907C** ..... **41-54**  
 Chrome bumper bolt w/  
 finish nut & washers.  
 7.874-0.15 ..... **\$2.75 EA** ⚠️

## Pad Bumper

- 594538** ..... **35-37**  
 Between bumper  
 support bar & face bar  
 at mounting bolts (5  
 pcs). 7.843-0.15  
**\$65.25 SET** ⚠️

## Bumper Bracket

- Note: Bumper brackets are supplied in raw  
 steel. Preparation will be required before paint.  
**594200** ..... **37**  
 Rear, fits Master. 7.843-0 ..... **CALL** ⚠️  
**594457** ..... **37**  
 Front, fits Master.  
 7.843-0.2 .....  
**\$218.50 L&R** ⚠️  
**350510B** ..... **38-39**  
 Front 7.843-0.15 .....  
**\$235.50 L&R** ⚠️  
**597858B** ..... **38-39**  
 Rear, except SDL  
 7.843-0.1 .....  
**\$291.25 L&R** ⚠️  
**3653342B** ..... **40**  
 Front 7.843-0 .....  
**\$138.50 L&R** ⚠️  
**3653348B** ..... **40**  
 Rear (exc wagon)  
 7.843-0.15 .....  
**\$195.50 L&R** ⚠️  
**3658307** ..... **41**  
 Bumper brackets front 7.836-0.15 .....  
**\$220.00 SET** ⚠️  
**3658336** ..... **41-42**  
 Bumper Brackets Rear -0.15 .....  
**\$175.00 EA** ⚠️  
**3681256A** ..... **46-48**  
 Bumper Brackets Front -0.15 .....  
**\$265.00 SET** ⚠️

## Bumper Bracket, cont.

- 3681257A** ..... **46-48**  
 Bumper Bracket- Rear (Exc. Wag. & Sed.  
 Del.) -0.15 ..... **\$197.00 SET** ⚠️  
**3688286A** ..... **49-52**  
 Front 7.836-0 ..... **\$185.00 L&R** ⚠️  
**3688291A** ..... **49-52**  
 -0 ..... **\$165.00 SET** ⚠️  
**3697695A** ..... **53**  
 Front 7.836-0 ..... **\$185.00 L&R** ⚠️  
**3697987A** ..... **53-54**  
 -0 ..... **\$165.00 SET** ⚠️  
**3697693AL** ..... **54**  
 Front Bumper Bracket  
 Outer Support Made  
 From Aluminum.  
 7.836-0.15 ..... **\$130.00 L&R** ⚠️  
**3704565A** ..... **54**  
 Front 7.836-0 ..... **\$165.00 L&R** ⚠️  
**Bumper Grommet Front Bracket**  
**594569** ..... **37-38**  
 Straight axle (4 pcs).  
 7.792-0.4 .....  
**\$32.25 SET** ⚠️  
**595161-2** ..... **37-38**  
 Bumper bracket (knee  
 action). 7.792-0.15 .....  
**\$37.75 L&R** ⚠️  
**350791-2** ..... **39**  
 Rubber 7.792-0.15 .....  
**\$54.75 PR** ⚠️  
**3654115** ..... **40**  
 Rubber 7.792-0.15 .....  
**\$43.00 PR** ⚠️  
**3658832** ..... **41**  
 Rubber 7.792-0.15 .....  
**\$39.50 PR** ⚠️  
**Bumper Grommet Rear Bracket**  
**594348** ..... **37**  
 Master 7.792-0.15 .....  
**\$45.25 PR** ⚠️  
**597754** ..... **37-38**  
 37 Master Deluxe.  
 7.792-0.15 .....  
**\$48.00 PR** ⚠️  
**350670** ..... **39**  
 Rubber 7.792-0.15 .....  
**\$54.75 PR** ⚠️

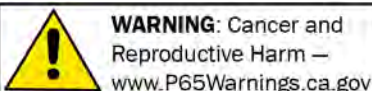

Chemicals shipped domestic ground only (Lower 48 states only). No international shipping.

Phone: (360) 816-0211 • (800) 999-CHEV (2438) • [www.chevsofthe40s.com](http://www.chevsofthe40s.com)



# Section 230C: Bumpers, Bumper Brackets, Splash Aprons, License Brackets, License Frames & Continental Kits

## Bumper Grommet Rear Bracket, cont.

**3654109** ..... **40**  
Rubber 7.792 -0.15  
**\$53.50 PR** ⚠

**3688285A** ..... **49-52**  
Rubber 7.792 -0.15  
**\$35.25 PR** ⚠

## Bumper Splash Apron Front

**3688439** ..... **49-50**  
Die-stamped. Steel.  
1.287 -0 ..... **\$278.25 EA**

**3697958** ..... **53**  
Die-stamped Steel.  
1.287 -0.15 ..... **\$301.75 EA** ⚠

## Bumper Splash Apron Rear

**3689015** ..... **49-52**  
Rear splash apron to bumper. 49-50(EXC Station Wagon) 51-52 Sedan Delivery only.  
7.833 -0.15 ..... **\$231.50 EA** ⚠



**3702008** ..... **53-54**  
Die-stamped. Rear splash apron, exc Station Wagon & Sedan Delivery 7.833 -0.15  
..... **\$229.00 EA** ⚠



**3702008B** ..... **53-54**  
Installation kit. 7.833 -0.4 ..... **\$4.00 SET** ⚠

## Bumper Splash Apron Pad

**594527** ..... **37-39**  
Rear bumper bracket (5 pcs). 7.843 -0 ..... **CALL** ⚠

## Splash Apron Bumpers Rubber

**3664645** ..... **41-48**  
Rear splash apron to body (6 pcs). 7.833 -0.3  
..... **\$6.00 SET** ⚠

**3700014** ..... **42-54**  
W/ 2 tips, front splash apron to bumper brackets. 1.286 -0.3  
**\$13.50 PR** ⚠

## Splash Apron Seal

**3660389** ..... **41-48**  
Rear splash apron to bumper. 7.833 -0.3  
**\$35.00 EA** ⚠

**3688583** ..... **49-56**  
Rear splash apron to bumper. 7.833 -0.15  
**\$58.50 EA** ⚠

## License Accessories

**985096** ..... **37-64**  
Chome Diamond, choose diamond color: clear, amber, red, green, blue, purple.  
9.777 -0.15 ..... **\$14.00 EA** ⚠

**10887** ..... **ALL**  
Chrome bullet wing nut license fastener. Set of 4 -0.15 ..... **\$6.25 SET** ⚠



**985094** ..... **ALL**  
Glass jewel reflector. Specify Red, Green, Blue, Amber, Burnt Orange, Purple, Clear, Light Blue, Yellow, Rainbow. (2 pcs).  
9.777 -0.2 ..... starting at **\$20.00 PR** ⚠



**985094P** ..... **ALL**  
Plastic jewel reflector. Red (2 pcs). 9.777 -0.15  
..... **\$3.25 PR** ⚠

**FLAG01** ..... **ALL**  
License Plate Frame Accessory, U.S.A. Flag -0.4  
..... **\$3.25 EA** ⚠

**FLAG02** ..... **ALL**  
Flag Holder -chrome 5 Post -0.15  
..... **\$12.00 EA** ⚠

**FLAG03** ..... **ALL**  
Flag Holder-Chrome 3 Post -0.15  
..... **\$12.25 EA** ⚠

## License Plate Toppers

**PLATETOP48** ..... **ALL**  
48 Star Flag -0 ..... **\$17.00 EA** ⚠

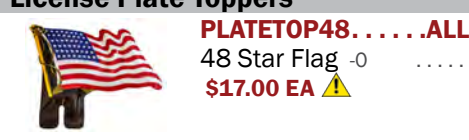

## License Plate Toppers, cont.

**PLATETOPCAT** ..... **ALL**  
Cat with moving eyes and tongue. -0 ..... **\$19.50 EA** ⚠

**VPALPT007AB** ..... **ALL**  
Chrome Safety Star With Amber Led Illumination -0.15  
..... **\$44.00 EA** ⚠

**VPALPT007GN** ..... **ALL**  
Chrome Safety Star With Green Led Illumination -0 ..... **CALL** ⚠

**VPALPT007RD** ..... **ALL**  
Chrome Safety Star With Red Led Illumination -0.15  
..... **\$44.00 EA** ⚠

**VPALPT008** ..... **ALL**  
Pegasus (Drive Safely) -0.15  
..... **\$17.00 EA** ⚠

## License Plate Frame

**986710** ..... **37-54**  
Year on top and "Chevrolet" on bottom of frame. Choose 1937-1954 (Exc 43-45). Specify year when ordering. (2 pcs). - Made For Modern Plates 9.777 -0 starting at **\$18.50 SET** ⚠

**986708** ..... **ALL**  
Telescoping (8 pcs), 2 ribs on end of each piece. Polished stainless. Original accessory 48-55. 9.777 -0.15  
..... **\$50.75 EA** ⚠



**986708** ..... **ALL**  
Telescoping (8 pcs), 2 ribs on end of each piece. Polished stainless. Original accessory 48-55. 9.777 -0.15  
..... **\$50.75 EA** ⚠

## License Plate Bracket

**597893** ..... **35-38**  
Front 7.796 -0.15  
**\$71.50 EA** ⚠

**595565A** ..... **37-39**  
License on left tail light. 2.662 -0 ..... **CALL** ⚠

**3654012** ..... **39-40**  
Front 7.796 -0.15  
**\$34.00 EA** ⚠





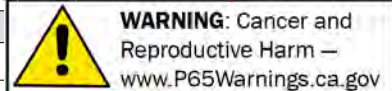

**604288** ..... **39-48**  
License plate-39 on trunk and 40-48 Sedan Delivery on back door  
2.662 -0.15 ..... **\$45.00 EA** ⚠

Returns require a return authorization number—call first. • Product pricing & availability subject to change.



# Section 230C: Bumpers, Bumper Brackets, Splash Aprons, License Brackets, License Frames & Continental Kits

## License Plate Bracket, cont.

-  **3658840**..... **41**  
Front 7.796 -0.2 ..
- \$30.75 EA** ⚠️
-  **3658843**..... **41**  
License Plate Guard,  
Front Support Bracket  
7.796 -0.15 .....
- \$26.50 EA** ⚠️
-  **3681292**..... **46-48**  
Front 7.796 -0.3 ..
- \$37.50 EA** ⚠️
-  **3692649**..... **49-50**  
Front 7.796 -0.15 .
- \$12.00 EA** ⚠️
-  **3695392**..... **51-52**  
Front 7.796 -0.15 .
- \$15.75 EA** ⚠️
-  **3700404**..... **53-55**  
Front 7.796 -0.15 .
- \$10.25 EA** ⚠️
- 3690156** ..... **53-56**  
Rear License Plate Bracket 2.669 -0  
..... **\$50.00 EA** ⚠️

## License Plate Bracket Bumper

-  **3690175**..... **49-50**  
Rubber behind license  
plate bracket on front  
bumper. 10.587 -0.4  
..... **\$1.50 PR** ⚠️

## License Plate Bracket Bolts

-  **126358**..... **41**  
Front (2 pcs). 7.796 -0.4  
... **\$1.25 SET** ⚠️

## Odds & Ends

Please call for availability on all Odds & Ends parts. Once part is sold, it may no longer be in stock.

- 350510**..... **39**  
Bumper Bracket Front Inner Right  
17.000 -0.4 ..... **\$20.00 EA** ⚠️
- 350512**..... **39**  
Bumper Bracket Front Outer Right  
17.000 -0.4 ..... **\$20.00 EA** ⚠️
- 3654097U** ..... **40**  
Guard Front or Rear (Used) 17.000 -0.4 ...  
**\$100.00 EA** ⚠️
- 09660**..... **41**  
Accy. Front Grille Guard Bar, Right  
17.000 -0.4 ..... **\$40.00 EA** ⚠️
- 3658266A** ..... **41**  
Bumper-front Face Bar-nos 17.000 -0  
..... **EA** ⚠️
- 3658344A** ..... **41**  
Bumper-rear Face Bar-nos 7.831 -0 . **CALL** ⚠️
- 3658744**..... **41**  
License plate guard, used in good  
condition 7.799 -0 ..... **\$60.00 EA** ⚠️

## Odds & Ends, cont.

- 3664399** ..... **42**  
Bumper Guard. Rear (Used) 7.828 -0 .....
- \$60.00 EA** ⚠️
- 3683666** ..... **47-55**  
BUMPER BRACKET - FRONT, INNER LEFT  
7.836 -0.4 ..... **\$30.00 EA** ⚠️
- 3688294** ..... **49-50**  
Bumper Bracket,outer Rt R 51-52 Sedan  
Delivery 17.000 -0.4 ..... **\$20.00 EA** ⚠️
- 3688584U** ..... **49-50**  
Rear splash apron. Fist 51-52 SDL (Used)  
17000.000 -0.2 ..... **\$200.00 EA** ⚠️
- 3688292** ..... **51-52**  
Bumper bracket. Rear, inside right. Fits  
51-52 SDL. 7.836 -0.4 ..... **\$30.00 EA** ⚠️

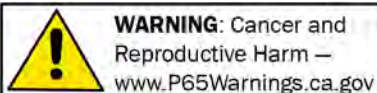

Chemicals shipped domestic ground only (Lower 48 states only). No international shipping.

Phone: (360) 816-0211 • (800) 999-CHEV (2438) • www.chevsofthe40s.com



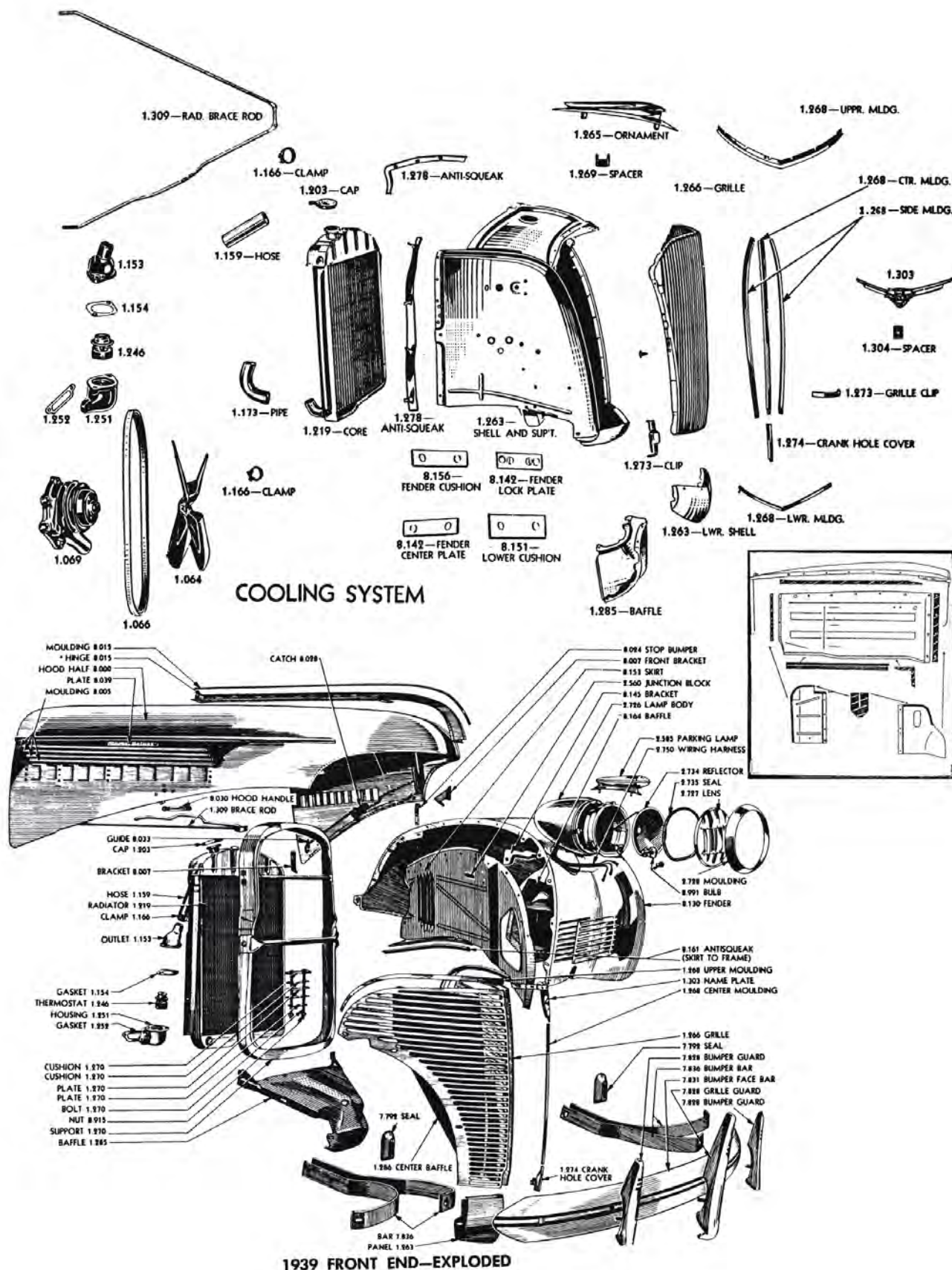

Returns require a return authorization number—call first. • Product pricing & availability subject to change.

**WARNING:** Cancer and Reproductive Harm — www.P65Warnings.ca.gov







**SECTION 240C  
RESTORATION PARTS**

Note: Oversize shipping charges apply on all Grilles. Please call for rates.

Note: We recommend that our chrome grilles be clear coated prior to final install for added protection

Note: Billet Aluminum Grilles take 6-12 weeks for delivery.

Grilles are grouped by year and components with street rod grilles listed first

**1937 Grille**

**594624BS** ..... 37  
Stainless steel. Hand made in USA  
1.266 -0

..... **\$975.00 EA** ⚠

**594624SS** ..... 37  
Stainless steel. Hand made in USA  
1.266 -0

..... **\$1,775.00 EA** ⚠

**1951-52 Grille Extension for Park Lights**

**3699643B** ..... 51-52  
Horseshoes around park lights. 1.268 -0.15

..... **\$325.00 L&R** ⚠

**Grille 1937 Billet Aluminum Bars**

Note: Billet Aluminum Grilles take 6-12 weeks for delivery.

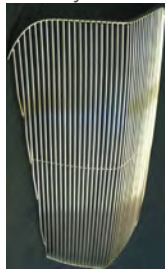

**594624BNF** ... 37  
Polished (face of bars only), 1/4in. bar spacing. No crank hole. 1.266 -0  
..... **\$1,175.00 EA** ⚠

**594624BNP** ..... 37  
Fully Polished, 1/4in. bar spacing. No crank hole. 1.266 -0

**594624BWF** ... 37  
Polished (face of bars only), stock 3/8in. bar spacing. No crank hole. 1.266 -0  
..... **\$950.00 EA** ⚠

**594624BWP** ..... 37  
Fully Polished, stock 3/8in. bar spacing. No crank hole. 1.266 -0

..... **\$1,175.00 EA** ⚠

**Grille 1937 Stainless**



**594624S** ..... 37  
Unpolished repro. Has crank hole. 1.266 -0  
..... **CALL** ⚠



**594624SS** ..... 37  
POLISHED REPRO. Has crank hole. 1.266 -0  
..... **CALL** ⚠

**Grille 1937 Gangster**



**594624LP** ..... 37  
Plain steel, laser cut. No crank hole. 1.266 -0.15  
..... **\$558.50 EA** ⚠



**594624LS** ..... 37  
Laser cut. Polished stainless. No crank hole. 1.266 -0.15  
..... **\$739.50 EA** ⚠

**Grille 1937 Emblem**



**595376** ..... 37  
Chrome. 1.303 -0 ..... **\$112.50 EA** ⚠  
**595376B** ..... 37  
Chrome. 1.303 -0 ..... **\$80.00 EA** ⚠



**595376P** ..... 37  
Chrome with painted details. 1.303 -0  
..... **CALL** ⚠

**Grille 1937 Moulding**



**594721** ..... 37  
Side moulding. Cut to length. 1.268 -0  
..... **\$199.25 L&R** ⚠



**594731** ..... 37  
Bottom of grille, cut to length. 1.268 -0.15  
..... **\$125.00 EA** ⚠

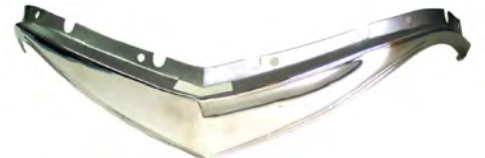

**594732** ..... 37  
Upper moulding. Polished stainless. 1.268 -0.15  
..... **\$315.00 EA** ⚠



**594732F** ..... 37  
Fiberglass upper moulding. 1.268 -0  
..... **CALL** ⚠



**595539** ..... 37  
Clips 4 piece set. (2 sets required) 1.269 -0.15  
..... **\$14.00 SET** ⚠

**Grille 1937 Center Strip**



**594722** ..... 37  
Stainless steel, w/ hole for emblem. Stock length. 1.268 -0.15  
..... **\$78.50 EA** ⚠



**594722N** ..... 37  
Stainless steel, no hole for emblem. Stock length. 1.268 -0.15  
..... **\$86.50 EA** ⚠



**594722S** ..... 37  
Stainless steel. 1 piece, covers crank hole. No hole for emblem. 1.268 -0.15  
..... **\$165.75 EA** ⚠

**Grille 1937 Crank Hole Cover**



**594754** ..... 37  
Stainless. Fits stock grille. 1.274 -0.15  
..... **\$63.25 EA** ⚠

**Grille 1937 Crank Hole Cover, cont.**



**594754R..... 37**  
For replacement grille  
(pt #594624S & LS).  
Polished stainless (does  
not fit stock grille).

1.274 -0.3 ..... **\$31.00 EA** ⚠

**Grille 1938 Gangster**



**597529LP ..... 38**  
Plain steel, laser cut.  
Offset bar sizing.  
No crank hole.  
1.266 -0.15  
..... **\$537.50 EA** ⚠



**597529LS ..... 38**  
Polished stainless,  
laser cut. Offset  
bar sizing. No crank  
hole. 1.266 -0.15  
..... **\$843.00 EA** ⚠



**597529LSM ... 38**  
Polished stainless,  
laser cut. Even bar  
sizing. No crank  
hole. 1.266 -0.15  
..... **\$834.75 EA** ⚠

**Grille 1938 Emblem**



**597714 ..... 38**  
Chrome, unpainted.  
1.303 -0  
..... **CALL** ⚠



**597714P ..... 38**  
Chrome, painted  
details. 1.303 -0  
..... **CALL** ⚠

**Grille 1938 Center Strip**



**597485..... 38**  
Stainless Steel 1.268 -0.15 ..... **\$93.75 EA** ⚠

**Grille 1938 Center Strip Clips**



**597463 ..... 38**  
Clips for center strip.  
Uses 2. 1.269 -0.4 ...  
..... **\$15.00 PR** ⚠

**Grille 1938 Crank Hole Cover**



**594929 ..... 38**  
Stainless. 1.274 -0.15  
..... **\$43.25 EA** ⚠

**Grille 1939 Gangster**



**350339LP ..... 39**  
Plain steel, laser cut. No crank hole.  
1.266 -0.1 ..... **\$646.25 EA** ⚠



**350339LS ..... 39**  
Polished stainless, laser cut. No crank  
hole. 1.266 -0.15 ..... **\$925.00 EA** ⚠

**Grille 1939**

**350339U ..... 39**  
Used With Upper Mouldings, Center Bar &  
Grille Emblem -0 ..... **\$900.00 L&R** ⚠

**Grille 1939 Upper Mouldings**



**3506195 ..... 39**  
Grille mouldings. Left and right side.  
1.268 -0.3 ..... **\$199.00 PR** ⚠

**Grille 1939 Emblem**



**350602..... 39**  
W/ fasteners. 1.303 -0 ..... **CALL** ⚠

**Grille 1939 Center Strip**



**350628 ..... 39**  
Stainless Steel  
1.268 -0.15  
..... **\$84.00 EA** ⚠

**Grille 1939 Center Strip Clips**



**350653 ..... 39**  
Clips for center strip.  
Uses 2. 1.269 -0.15 ...  
..... **\$15.00 SET** ⚠

**Grille 1939 Crank Hole Cover**



**350647 ..... 39**  
Stainless. 1.274 -0.15  
..... **CALL** ⚠

**Fender Grilles 1939**



**603837..... 39**  
Polished Stainless Steel. No hardware  
included. 8.168 -0 ..... **\$250.00 L&R** ⚠



**603837LS..... 39**  
Polished Stainless Steel, Laser Cut.  
1.266 -0.15 ..... **\$135.00 L&R** ⚠

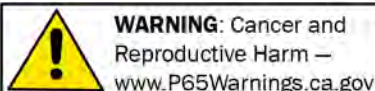

**WARNING: Cancer and Reproductive Harm** —  
www.P65Warnings.ca.gov

Chemicals shipped domestic ground only (Lower 48 states only). No international shipping.

**Phone: (360) 816-0211 • (800) 999-CHEV (2438) • www.chevsofthe40s.com**



**Grille 1940 Billet Aluminum**



**3653525B** ..... 40  
 Billet Grille for your '40 Chevy Car or Sedan Delivery. Aluminum with polished face, powder coated back side to give it a one of a kind "floating" look. And you can only get it at Chev's of the 40's! 1.266-0  
**CALL** ⚠

**Grille 1940 Gangster**

**3653525LP** ..... 40  
 Bare steel. Laser cut. 1.266-0.15 .....  
**\$728.50 EA** ⚠



**3653525LS** ..... 40  
 Polished stainless. Laser cut. 1.266-0 .....  
**\$1,100.00 EA** ⚠

**Grille 1940 Center Strip**



**3653827** ..... 40  
 Stainless steel.  
 1.268-0.15 .....  
**\$96.00 EA** ⚠

**Grille 1940 Crank Hole Cover**



**3653875** ..... 40  
 Stainless. 1.274-0.15 .....  
**\$43.25 EA** ⚠

**Grille 1941 Billet Aluminum**

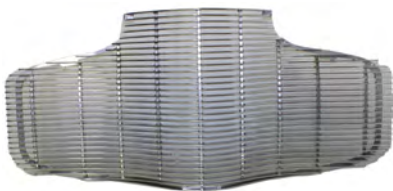

**3658060B0** ..... 41  
 Billet aluminum with extended bars over fenders. Polished face of bars, powdercoated backside. The ends of the grille overlap the fender and eliminates mouldings. Includes hardware. Fits cars & Sedan Delivery. 1.266-0.15 .....  
**\$1,800.00 EA** ⚠

**Grille 1941**

Note: We recommend that our chrome grilles be clear coated prior to final install for added protection



**3658060R** ..... 41  
 Replated, original grille. 1.266-0 .. **CALL**  
 ⚠

**Grille 1941 Surround**



**3658075** ..... 41  
 Chrome top name plate "CHEVROLET". Drive quality 1.303-0.15 .....  
**\$197.50 EA** ⚠

**Grille 1941 Crank Hole Cover**



**3658557** ..... 41  
 Chrome 1.274-0.15 .....  
**\$91.25 EA** ⚠

**Grille 1942 Crank Hole Cover**



**3664899** ..... 42  
 Stainless. 1.274-0.4 .....  
**\$28.50 EA** ⚠

**Grille 1946 Lettering**



**3676573** ..... 46  
 Vinyl, red for lower grille bar. 1.266-0.15 .....  
**\$21.00 EA** ⚠

**Grille 1947-48 Lettering**



**3690280C** ..... 47-48  
 Lettering for top grille bar. Vinyl-red. 1.266-0.15 .....  
**\$22.00 EA** ⚠

**Grille 1948 T-Bolt**



**3687099** ..... 48  
 Propeller, at top of grille T-bar. 1.269-0.4 .....  
**\$25.00 EA** ⚠

**Grille 1949 Lettering**



**3688406A** ..... 49  
 Vinyl, black for top grille bar. 1.266-0.15 .....  
**\$21.00 EA** ⚠

**Grille 1949-50 Lower Bar**



**3693966** ..... 49-50  
 Chrome 1.268-0.15 .....  
**\$313.50 EA** ⚠

**Grille 1949-50 Center Bar**



**3688271** ..... 49-50  
 Chrome 1.268-0.15 .....  
**\$315.75 EA** ⚠

**Grille 1949-50 Upper Bar**



**3688269** ..... 49-50  
 Chrome upper Grill Bar w/ lettering. 1.268-0.15 .....  
**\$311.25 EA** ⚠

**Grille 1950 Decals**



**3692600B** ..... 50  
 Vinyl striping for vertical grille bars, blue. 1.266-0.15 .....  
**\$10.50 SET** ⚠

**Grille 1950 Lettering**



**3692600A** ..... 50  
 Vinyl, blue for top grille bar. 1.266-0.15 .....  
**\$21.00 EA** ⚠

**1951 Grille Center Moulding**

**3694927A** ..... 51  
 Center bar Chrome Plated 1.268-0 .....  
**\$295.00 EA** ⚠

**Grille 1951 Lettering**

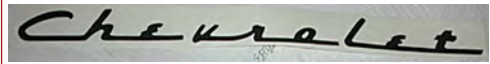

**3699642A** ..... 51  
 Vinyl, black for top grille bar. 1.266-0.15 .....  
**\$21.00 EA** ⚠

**1952 Grille Center Moulding**

**3699632A** ..... 52  
 Center Bar Chrome Plated 1.268-0 .....  
**\$295.00 EA** ⚠

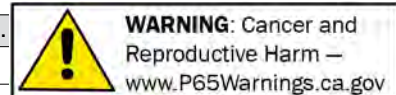

**Grille 1953 Teeth**

**3703148** ..... **53**  
Center. Chrome. 1.268 -0 ..... **CALL** ⚠



**3703148B** ..... **53**  
Grille teeth. Chrome (3 pcs). 1.268 -0.15  
**\$333.75 SET** ⚠



**3703151** ..... **53**  
Left. Chrome.  
1.268 -0  
..... **CALL** ⚠



**3705152** ..... **53**  
Right. Chrome.  
1.268 -0  
..... **CALL** ⚠

**Grille 1953 Bolt Kit**

**3705080B** ..... **53**  
Grille installation. 1.269 -0.15 .....  
**\$12.75 SET** ⚠

**Grille 1953 Bar**



**3703145** ..... **53**  
Upper grille bar 1.268 -0.15 ..... **\$313.50 EA**  
⚠



**3703146** ..... **53**  
Center grille bar 1.268 -0.15 ..... **\$313.50 EA**  
⚠



**3703147** ..... **53**  
Lower grille bar 1.268 -0.15 ..... **\$313.50 EA**  
⚠

**Grille 1953 Extensions**



**3703149B** ..... **53**  
Chromed grill extensions. 1.268 -0 .....  
**\$243.50 L&R** ⚠

**Grille 1954 Teeth**



**37005311B** ..... **54**  
Grille teeth. Chrome (5 pcs). 1.268 -0.15  
**\$390.25 SET** ⚠

**Grille 1954 Bar**



**3705305** ..... **54**  
Upper grill bar 1.268 -0.15 ..... **\$313.50 EA**  
⚠



**3705306** ..... **54**  
Grille bar (center). 1.268 -0.15 .....  
**\$315.75 EA** ⚠

**Grille 1954 Extension for Park Lights**



**3705307B** ..... **54**  
Chromed park light extensions. 2.599 -0.15  
..... **\$261.75 PR** ⚠



**3705307C** ..... **54**  
cast aluminum brackets for park light  
housings. 2.599 -0.2 ..... **\$24.00 PR** ⚠

**Grille 1954 Bolt Kit**



**3705298B** ..... **54**  
Grille installation. 1.269 -0.3 ..... **\$15.00 SET**  
⚠

**Corvette Grille**



**3706490** ..... **53-57**  
Great look for a unique front end on your  
street rod. Order as original replacement  
for 53-57 Corvettes. Chrome, 13 teeth. 40  
inches overall length. 1.266 -0.15 .....  
**\$619.75 EA** ⚠

**3706490A** ..... **53-57**  
Great look for a unique front end on your  
street rod. Order as original replacement  
for 53-57 Corvettes. Chrome, 13 teeth. 40  
inches overall length. Without Brackets  
1.266 -0 ..... **\$619.00 EA** ⚠



**3706491** ..... **53-57**  
Great look for a unique front end on your  
street rod. Chrome, 17 teeth. 50 inches  
overall length. 1.266 -0 ..... **CALL** ⚠



**3706492** ..... **53-57**  
Great look for a unique front end on your  
street rod. Chrome, 19 teeth. 55.5 inches  
overall length. 1.266 -0 ..... **CALL** ⚠

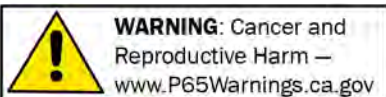

Chemicals shipped domestic ground only (Lower 48 states only). No international shipping.

**Phone: (360) 816-0211 • (800) 999-CHEV (2438) • www.chevsofthe40s.com**



**Grille Shell**

Grill shells must be sent freight collect. Call for rate.



**602608** ..... **37**  
Fiberglass. 1.263 -0.15

..... **\$540.00 EA** ⚠



**602953** ..... **38**  
Fiberglass. 1.263 -0

**CALL** ⚠

**Panel Below Grille**

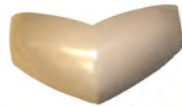

**593654** ..... **37**  
Steel. 1.263 -0.15

**\$100.50 EA** ⚠



**593654F** ..... **37**  
Fiberglass. 1.263 -0.15

..... **\$149.25 EA** ⚠



**603097** ..... **38**  
Fiberglass. 1.263 -0

**CALL** ⚠



**350315** ..... **39**  
Fiberglass. 1.263 -0.15

..... **\$134.00 EA** ⚠

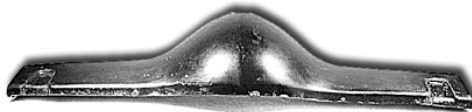

**3653401** ..... **40**  
Fiberglass. 1.263 -0.15

.. **\$186.00 EA** ⚠



**3658214** ..... **41**  
Fiberglass. 1.263 -0.15

.. **\$211.75 EA** ⚠

**Radiator Brace (V-Rod)**



**597498** ..... **37-38**  
Radiator To Cowl (polished Stainless Steel)  
1.309 -0.15

..... **\$159.75 EA** ⚠

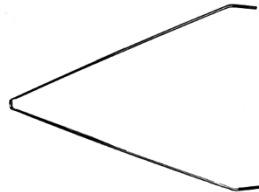

**350332** ..... **39**  
39 Car. Radiator to cowl. Polished  
stainless steel. 1.309 -0.15

..... **\$202.50 EA**  
⚠

**Core Support Pads And Shims**



**367314** ..... **33-54**

Radiator core support  
mount 1.270 -0.3

..... **\$10.00 SET** ⚠

**Core Support Bolt Kit**

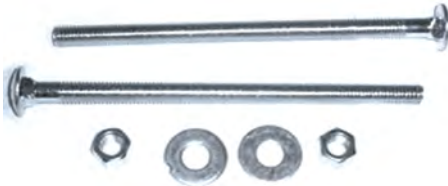

**458395** ..... **37-39**  
Radiator core support to frame. 1.270 -0.2

..... **\$3.50 SET** ⚠

**3676480** ..... **40-54**

Radiator core support  
to frame. 1.270 -0.4

..... **\$3.25 SET** ⚠

**Odds And Ends**

Please call for availability on all Odds & Ends parts. Once part is sold, it may no longer be in stock.

**350315U** ..... **39**

Panel below grille. Fiberglass, needs  
some work (Used). 1.263 -0.4

..... **\$30.00 EA**  
⚠

**3655436** ..... **40**

Grille Center Moulding, Top (NOS)

18.000 -0.4

..... **\$175.00 EA** ⚠

**3655436P** ..... **40**

Grille center moulding. Upper, polished.

1.268 -0.4

..... **\$100.00 EA** ⚠

**985592** ..... **40**

Grille guard accessory w/out emblem  
(Master Deluxe) 7.828 -0.4

..... **\$150.00 EA** ⚠

**985592RC** ..... **40**

Grille guard accessory without emblem  
rechromed (beautiful) 7.828 -0

..... **\$150.00 EA** ⚠

**3658060U** ..... **41**

Grille- Used 18.000 -0

..... **\$550.00 EA** ⚠

**3658068U** ..... **41**

Grille Moulding, Upper Right, Used

18.000 -0.4

..... **\$75.00 EA** ⚠

**3658303R** ..... **41**

Moulding Grille Center Upper 2.013 -0.15

..... **\$190.00 EA** ⚠

**3658303U** ..... **41**

Moulding Grille Center Upper 2.013 -0.4

..... **\$50.00 EA** ⚠

**985708** ..... **41**

Grille guard end piece. Right side.

7.828 -0.4

..... **\$50.00 EA** ⚠

**5936674** ..... **46-48**

Rim (trim ring) for spotlight (NOS)

7.000 -0.4

..... **\$15.00 EA** ⚠

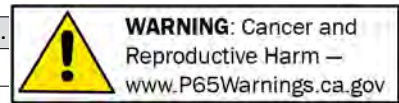

**SECTION 250C  
STREET ROD PARTS**





**Hood Deflector**







**C5018**.....ALL  
Classic "Bi-Flector" accessory attaches to hood center strip. Choose Amber, Blue, Clear, Green or Red. -0 .....starting at **\$13.00 EA** ⚠

**Hood Fiberglass**

Note: Oversize shipping charges apply on all Hoods. Please call for rates.

-  **602971F**..... **38**  
1 piece top section.  
8.000-0 .. **CALL** ⚠
-  **603359FT**..... **39**  
1 piece top section.  
8.002-0 .. **CALL** ⚠
-  **3653889F**..... **40**  
1 piece top section.  
8.000-0 .. **CALL** ⚠
-  **3657895F**..... **41**  
Fiberglass Hood 8.000-0  
..... **CALL** ⚠

**Hood Sides Fiberglass**

-  **602565F**..... **37**  
Hood sides, smooth.  
8.001-0 .. **CALL** ⚠
-  **602565FS**..... **37**  
Hood sides w/ recessed scoop. 8.001-0  
..... **CALL** ⚠
-  **602973F**..... **38**  
Hood sides, smooth.  
8.001-0 .. **CALL** ⚠
-  **602973FS**..... **38**  
Hood sides w/ recessed scoop. 8.001-0  
..... **CALL** ⚠
-  **603360F**..... **39**  
Hood Sides Smooth.  
8.002-0 .. **CALL** ⚠
- 3651109F**..... **40**  
Upper rear left. 8.153-0 ..... **CALL** ⚠
- 3653110F**..... **40**  
Upper rear right. 8.153-0 ..... **CALL** ⚠

**Hood Prop**



**LPP-0401014**.....ALL  
Adjustable 3 different levels, universal mount. Polished. Includes brackets, fasteners & instructions. 12"-20" length. -0.15 .. **\$116.75 EA** ⚠



**LPP-0401024**.....ALL  
Adjustable 6 different levels universal mount. Polished. Includes brackets, fasteners & instructions. 12"-20" length. -0.15 .. **\$116.75 EA** ⚠

**XLPP-0401014**..... ALL  
Black anodized. Adjustable 3 different levels, universal mount. Polished. Includes brackets, fasteners & instructions. 12"-20" length. -0.15 .... **\$111.00 EA** ⚠

**XLPP-0401024**..... ALL  
Black anodized. Adjustable 6 different levels universal mount. Polished. Includes brackets, fasteners & instructions. 12"-20" length. -0.15 .. **\$116.75 EA** ⚠

**SECTION 250C  
RESTORATION PARTS**

**Decals Hood Emblem**



**3664615A** ..... **42**  
Color inserts for emblem. 8.055 -0.15  
..... **\$21.00 SET** ⚠



**3681683A** ..... **46**  
Color inserts for emblem. 8.055 -0.15  
..... **\$21.00 SET** ⚠



**3695332A** ..... **51**  
Decal, bowtie. Blue.  
8.055 -0.2 .....

**Hood Emblem**



**3653871**..... **40**  
Chrome with painted details 8.055 -0  
..... **CALL** ⚠

**Hood Emblem, cont.**



**3664351** ..... **47**  
Chrome with blue bowtie and red surround. 8.055-0 ..... **CALL** ⚠



**3664352** ..... **48**  
Chrome with blue bowtie. 8.055-0 .... **CALL** ⚠



**3688050** ..... **49**  
Hood emblem 8.039 -0.15 . **\$105.75 EA** ⚠

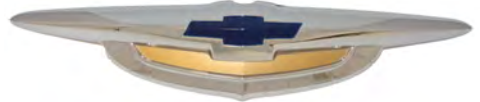

**3687425**..... **50**  
Chromed & Painted 8.055 -0.15 ..... **\$144.50 EA** ⚠



**3702726**..... **53**  
Plastic 8.055 -0.15 ..... **\$36.00 EA** ⚠



**3705033** ..... **54**  
Plastic 8.055 -0.15 ..... **\$48.50 EA** ⚠



**3705033B** ..... **54**  
Plastic w/ chrome bezel. 8.055 -0.15 .. **\$110.00 EA** ⚠

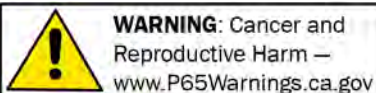

Chemicals shipped domestic ground only (Lower 48 states only). No international shipping.

Phone: (360) 816-0211 • (800) 999-CHEV (2438) • www.chevsofthe40s.com



**Hood Emblem Pad**

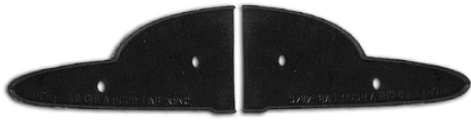

**3693312** ..... **50**  
Emblem to hood. 2 pcs. 8.055 -0.15 ...  
**\$28.75 SET** ⚠



**3702726P** ..... **53**  
Emblem to hood. 8.055 -0.15 .....  
**\$38.75 EA** ⚠

**Clips Hood Center Moulding**

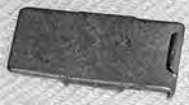

**3658783** ..... **41-48**  
Retains painted vertical nose moulding. 8.056 -0 .....  
**CALL** ⚠



**3688261** ..... **49-52**  
Retains hood center moulding. 8.056 -0.3 .....  
**\$5.00 EA** ⚠

**Clips Hood Side Moulding**



**4082247A** ..... **37**  
Clips for one side moulding (6 pcs). 10.695 -0.4 .....  
**\$12.50 SET** ⚠



**59752338** ..... **38**  
Bolts & clips for one side center moulding. 8.005 -0.4 .....  
**\$10.00 SET** ⚠



**597522** ..... **38-39**  
Side moulding (exc 38 center). 1 side moulding (6 pcs). 8.005 -0.3 .....  
**\$16.50 SET** ⚠

**Gasket Hood Ornament**

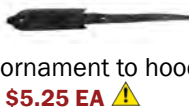

**3684376A** ..... **47-48**  
Standard hood ornament to hood. 1.265 -0.15 .....  
**\$5.25 EA** ⚠

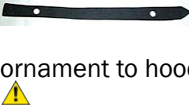

**3688253A** ..... **49-50**  
Standard hood ornament to hood. 1.265 -0 .....  
**\$4.25 EA** ⚠



**3695337A** ..... **51-52**  
Standard hood ornament to hood. 1.265 -0.3 .....  
**\$5.75 EA** ⚠

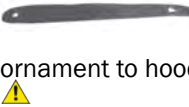

**3701529A** ..... **53-54**  
Standard hood ornament to hood. 1.265 -0 .....  
**\$5.75 EA** ⚠

**Hood Ornament**



**595073** ..... **37**  
Original accessory. 1.265 -0.15 .....  
**\$172.50 EA** ⚠



**597980** ..... **38**  
Chrome Driver Quality (not show Quality) 1.265 -0 .....  
**CALL** ⚠



**603476** ..... **39**  
Original Accessory 1.265 -0.15 .....  
**\$232.00 EA** ⚠



**3653546** ..... **40**  
Flying lady. Includes plastic insert. 1.265 -0 .....  
**CALL** ⚠



**985710** ..... **41**  
Flying lady. Includes plastic insert. 1.265 -0 .....  
**CALL** ⚠



**986410** ..... **50**  
Chrome bird, original accessory. 1.265 -0.15 .....  
**\$183.75 EA** ⚠

**Hood Ornament, cont.**



**986785** ..... **53**  
Chrome Accessory. 1.265 -0 .....  
**CALL** ⚠



**3705035** ..... **53-54**  
Original 54. Chrome. Superior quality! 1.265 -0.15 .....  
**\$142.00 EA** ⚠

**Hood Side Moulding**



**595209** ..... **37**  
Uses 2. 25" length. 8.005 -0.2 .....  
**\$94.00 EA** ⚠



**597516** ..... **38**  
Upper & Lower (uses 4) 8.005 -0.15 .....  
**\$56.50 EA** ⚠



**597557** ..... **38**  
Center (uses 2). 8.005 -0.15 .....  
**\$49.00 EA** ⚠

**3653276** ..... **39**  
Stainless. Uses 8. 8.005 -0.15 .....  
**\$37.50 EA** ⚠



**3653276S** ..... **39**  
Laser cut stainless. Gangster grille style. 8.005 -0.15 .....  
**\$220.75 PR** ⚠

**Hood Side Name Plate**



**3650152** ..... **39**  
Master 85. 6-5/8" long, 3/8" tall. 8.039-0  
..... **CALL** ⚠



**3651206** ..... **39**  
Master Deluxe. 7-3/16" long, 5/16" tall.  
8.039-0 ..... **\$44.50 EA** ⚠



**3682043** ..... **47-48**  
Fleetmaster 8.039-0.15 ... **\$375.00 PR**  
⚠



**3684199** ..... **47-48**  
Stylemaster 8.039-0 ..... **CALL** ⚠



**3684207** ..... **47-48**  
Fleetline 8.039-0 ..... **CALL** ⚠

**Plastic for Accessory Hood Ornament**

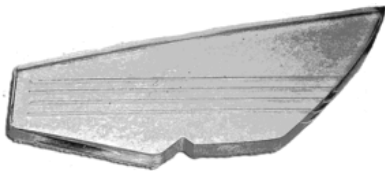

**350555A** ..... **39**  
1-7/8in. high, original (Used). 1.265-0  
..... **CALL** ⚠



**603476A** ..... **39**  
2-1/4in. high, original (Used). 1.265-0.15  
..... **\$36.25 EA** ⚠

**Plastic for Accessory Hood Ornament, cont.**

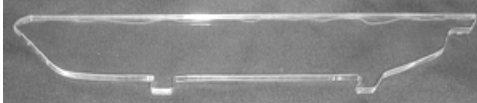

**604564** ..... **40-41**  
Clear, original. 1.265-0 ..... **CALL** ⚠



**604565** ..... **42**  
Clear 1.265-0 ..... **CALL** ⚠



**609582** ..... **46**  
Blue, original. 1.265-0.4 ..... **\$29.50 EA** ⚠



**3847124** ..... **47-48**  
Clear, original. 1.265-0.15 .. **\$35.00 EA**  
⚠



**3847124A** ..... **47-48**  
Amber, not original 1.265-0 ..... **CALL** ⚠



**3847124B** ..... **47-48**  
Blue. 1.265-0.4 ..... **\$35.00 EA** ⚠



**3847124G** ..... **47-48**  
Green, not original 1.265-0.15 .. **CALL**  
⚠



**986524A** ..... **49**  
Red, original. 1.265-0.15 .. **\$155.25 EA**  
⚠

**986524AB** ..... **49**  
Blue. 1.265-0 ..... **\$145.00 EA** ⚠

**986524AG** ..... **49**  
Green. 1.265-0 ..... **\$145.00 EA** ⚠

**Bullnose**

**3701990B** ..... **41**  
Car, replaces center strip & hood ornament. 57in. length x 1/2" wide, polished aluminum, w/ clips. 8.015-0.15  
..... **\$79.00 EA** ⚠

**3701990A** ..... **49-52**  
Car, replaces center strip & hood ornament. 55" length x 1/2" wide, polished aluminum, w/ clips. 8.015-0.15  
..... **\$79.25 EA** ⚠

**3701990B** ..... **53-54**  
Car, replaces center strip & hood ornament. 57in. length x 1/2" wide, polished aluminum, w/ clips. 8.015-0.15  
..... **\$79.00 EA** ⚠

**1940-41 Hood Hinge Springs**



**3659859** ..... **40-41**  
Black painted. 8.013-0.15 .. **\$49.75 PR**  
⚠

**3659859P** ..... **40-41**  
Polished stainless. 8.013-0.15 .....  
**\$133.00 PR** ⚠

**3659859S** ..... **40-41**  
Stainless. 8.013-0.15 .. **\$119.00 PR** ⚠

**1942-48 Hood Hinge Springs**

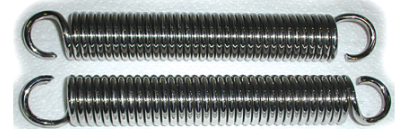

**3663756** ..... **42-48**  
8" length, 1-1/8" dia. 8.013-0.15 .....  
**\$36.75 PR** ⚠

**3663756P** ..... **42-48**  
Polished stainless. 8.013-0.15 .....  
**\$108.50 PR** ⚠

**3663756S** ..... **42-48**  
Stainless. 8.013-0.15 ..... **\$94.25 PR** ⚠

**1949-52 Hood Hinge Springs**

**3700259** ..... **49-52**  
Zinc coated 8.013-0.15 .. **\$45.00 PR** ⚠

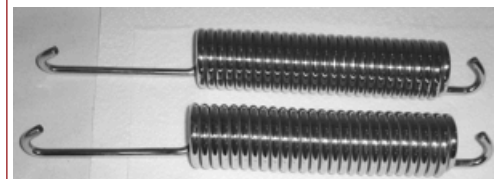

**3700259P** ..... **49-52**  
Polished stainless. 8.013-0.15 .....  
**\$161.75 PR** ⚠

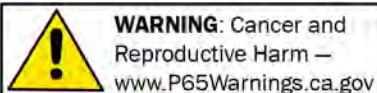

Chemicals shipped domestic ground only (Lower 48 states only). No international shipping.

**Phone: (360) 816-0211 • (800) 999-CHEV (2438) • www.chevsofthe40s.com**



**1949-52 Hood Hinge Springs, cont.**

**3700259S** ..... **49-52**  
Stainless. 8.013 -0.15 .. **\$127.50 PR** ⚠

**1953-54 Hood Hinge Springs**

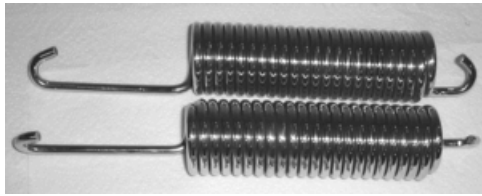

**3700260** ..... **53-54**  
Zinc coated. 8.013 -0.15 **\$45.00 PR** ⚠

**3700260P** ..... **53-54**  
Polished stainless. 8.013 -0.15 .. **\$199.75 PR** ⚠

**3700260S** ..... **53-54**  
Stainless. 8.013 -0 .. **\$141.75 PR** ⚠

**Hood Spring Tool**



**017531A** ..... **40-48**  
Hood spring installation & removal tool w/  
instructions. 8.015 -0.15 .. **\$65.75 EA** ⚠

**017531** ..... **49-54**  
Hood spring installation & removal tool w/  
instructions. 8.015 -0.15 **\$78.25 SET** ⚠

**Hood Hinge**



**594940A** ..... **37-38**  
Center of hood, galvanized steel. 8.015 -0.15  
..... **\$98.75 PR** ⚠



**594940S** ..... **37-38**  
Center of hood, stainless steel. 8.015 -0.15  
..... **CALL** ⚠



**3689235B** ..... **42-48**  
Black EDP Coated 8.015 -0 .. **\$199.00 PR** ⚠

**Hood Hinge Gasket**



**3664013A** ..... **42-48**  
These are hood hinge  
gaskets that are sold as  
a pair. 8.015 -0.4 ...

**\$17.00 SET** ⚠

**Hood Hinge Repair Pin**



**3688409B** ..... **42-48**  
Oversize pin. -0.2 .. **\$12.75 EA** ⚠



**3688409A** ..... **49-52**  
Oversize pin. Drill hole  
sizes;  
Base: 29-64"  
Arm: 5/16" -0.2 ...

**\$15.25 EA** ⚠

**Hood Hinge Bolt**

Note: Please measure the shoulder on your  
hinge bolts, then call our sales staff for the  
correct bolts



**3654368** ..... **40-54**  
Shouldered, 1/2in. hex  
head, 3/8in. shoulder,  
car (uses 4) (2 pcs).  
Verify Your Shoulder

Diameter 8.016 -0 .. **\$5.50 SET** ⚠



**3654368S** ..... **40-54**  
Stainless steel  
Shouldered, 1/2in. hex  
head, 3/8in. shoulder,  
car (uses 4) (2 pcs).  
Verify Your Shoulder Diameter 8.016 -0.15

..... **\$15.00 SET** ⚠



**3688414** ..... **40-54**  
1/2 in. hex head, 3/8  
in. shoulder (car uses 4)  
(2 piece set). 8.016 -0  
..... **\$6.75 PR** ⚠

..... **\$6.75 PR** ⚠



**3688414S** ..... **40-54**  
Stainless steel. 1/2 in.  
hex head, 3/8 in.  
shoulder, (car uses 4)  
(2 piece set). Verify  
Your Shoulder Diameter 8.016 -0.15 ..

..... **\$15.00 PR** ⚠



**3689234** ..... **40-54**  
5/8 in. hex head, 7/16  
in. shoulder (car uses 4)  
(2 piece set). Verify  
Your Shoulder Diameter  
8.016 -0.15 .. **\$5.50 PR** ⚠

..... **\$5.50 PR** ⚠

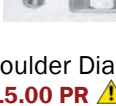

**3689234S** ..... **40-54**  
Stainless steel. 5/8 in.  
hex head, 7/16 in.  
shoulder (car uses 4) (2  
piece set). Verify Your  
Shoulder Diameter 8.016 -0.15 .. **\$15.00 PR** ⚠

..... **\$15.00 PR** ⚠

**Hood Prop Up**



**694175** ..... **36-38**  
Stainless, with Hardware 8.012 -0.15 .. **\$122.50 SET** ⚠

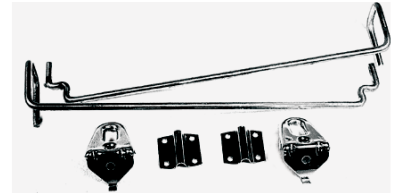

**3650180** ..... **39**  
W/ hardware. Stainless. 8.012 -0.15 .. **\$106.50 SET** ⚠

**Seal**



**3659648** ..... **41**  
Hood brace to radiator.  
8.010 -0.15 .. **\$11.00 EA** ⚠



**3688776** ..... **49-54**  
Hood Brace To Radiator  
8.010 -0.4 .. **\$17.50 EA** ⚠

**Hood To Cowl Seal**



**374969** ..... **29-39**  
Webbing with wire  
insert. 9.127 -0.15 .. **\$26.00 PR** ⚠



**374969A** ..... **29-40**  
Webbing, also radiator  
shell to hood (9 ft).  
9.127 -0.15 .. **\$12.00 EA** ⚠



**3658468A** ..... **40**  
Rubber. 9.127 -0 .. **\$18.00 PR** ⚠



**3654169** ..... **41**  
2 rubber strips.  
9.127 -0.2 .. **\$15.50 PR** ⚠



**3663805** ..... **42-48**  
Hood to side cowl. 9.127 -0.2 .. **\$40.50 PR** ⚠

**Hood To Cowl Seal, cont.**



**3663805E** ..... **42-48**  
Hood to side cowl. 9.127 -0.15 .....  
**\$87.75 PR** ⚠

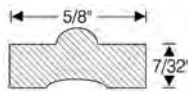

**3664008**..... **42-48**  
52 inches 9.127 -0.2  
..... **\$13.00 PR** ⚠



**3689070**..... **49-52**  
Rubber. 9.127 -0.15  
**\$30.75 PR** ⚠



**3689070E**..... **49-52**  
Rubber 9.127 -0.15  
**\$75.50 PR** ⚠

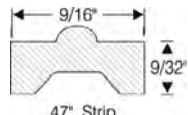

**3707799**..... **53**  
Rubber strip. 9.127 -0.15  
..... **\$63.50 EA** ⚠



**3707799A**..... **54**  
Rubber strip. 9.127 -0.15  
..... **\$63.50 EA** ⚠

**3664008BULK**..... **ALL**  
Rubber sold by the inch 9.127 -0.4  
**\$0.50 IN** ⚠

**Hood Latch Cup**



**3658835C** ..... **41-50**  
Hood latch cup,  
stainless. Sits on top of  
latch spring. 8.081 -0.15  
..... **\$36.00 EA** ⚠



**3658835PC** .... **41-50**  
Hood latch cup,  
polished stainless. Sits  
on top of latch spring.  
8.081 -0.15 .....  
**\$45.00 EA** ⚠

**Hood Latch Spring**



**3658835PS** .... **41-50**  
Hood latch spring,  
polished stainless. Sits  
in spring cup. 8.081 -0.15  
..... **\$31.25 EA** ⚠



**3658835S**..... **41-50**  
Hood latch spring,  
stainless. Sits in spring  
cup. 8.081 -0.15 ....  
**\$30.25 EA** ⚠

**Hood Latches**



**378004B**..... **37-38**  
On cowl & radiator  
shell. 8.005 -0.15 ...  
**\$121.50 SET** ⚠

**350542**..... **39**  
On cowl & radiator  
shell. 8.005 -0.2 ...  
**\$140.00 SET** ⚠

**Hood To Cowl Seal Retainers With Screws**



**3654168B** .... **29-54**  
For hood to cowl seal  
(Set of 8). 9.127 -0.4  
.. starting at **\$8.00 SET** ⚠

**Latch Bolt**



**3654098P** ..... **40-41**  
Adjustable, upper,  
polished stainless.  
8.083 -0.15 ..... **\$36.75 EA** ⚠



**3654098S** ..... **40-41**  
Stainless. Adjustable,  
upper. 8.083 -0.15  
**\$31.25 EA** ⚠



**3664720P**..... **42-48**  
Adjustable, upper,  
polished stainless.  
8.083 -0.15 ..... **\$37.50 EA** ⚠



**3664720S**..... **42-48**  
Adjustable, upper,  
stainless steel.  
8.083 -0.15 ..... **\$38.25 EA** ⚠

**Hood Cable Assembly**



**3664667**..... **40-49**  
W/ knob (nut to end of  
housing 71" length. 74"  
nut to end of wire).  
8.075 -0.4 .....  
**\$29.00 EA** ⚠

**Hood Choke And Throttle Cables Wire Stop**



**3655561**..... **ALL**  
Adjustable end for  
hood, choke, throttle  
cables, etc. 8.077 -0.4  
..... **\$1.00 EA** ⚠

**Hood Knob**



**3664667A** ..... **40-49**  
Script, brown. 3/16"  
I.D. shaft hole. 8.075 -0.4  
..... **\$7.00 EA** ⚠

**Hood Cable Grommet**



**3660587**..... **40-41**  
Under hood bracket.  
8.077 -0.15 .....  
**\$11.00 EA** ⚠



**3696314**..... **42-48**  
In latch plate. 9.775 -0.15  
..... **\$6.75 EA** ⚠

**Hood Handle**



**597521A**..... **36-46**  
Stainless 37-39 Cars  
36-46 Trucks. 8.030 -0.15  
..... **\$50.00 EA** ⚠

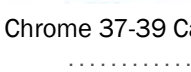

**597521P**..... **36-46**  
Plain steel, primered.  
Paintable, as original.

Chrome 37-39 Cars 36-46 Trucks. 8.030 -0  
..... **CALL** ⚠

**597521**..... **37-39**  
8.030 -0 ..... **\$37.00 EA** ⚠

**Under Hood Light**



**986250**..... **49-54**  
Super reproduction! 8.890 -0 ... **CALL** ⚠

**Hood Corners**



**3678834** ..... **37-39**  
Rubber (uses 4). 8.024 -0.15 .....  
**\$12.00 PR** ⚠

**Grille Shell Rubber Pads**



**594777BE** ..... **37**  
Top strip. Grille shell to hood (2 pcs),  
1.278 -0.15 ..... **\$82.75 PR** ⚠



**595809B** ..... **37**  
Vertical strip. Grille shell to hood (2 pcs).  
1.278 -0.15 ..... **\$47.50 PR** ⚠

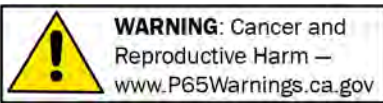

Chemicals shipped domestic ground only (Lower 48 states only). No international shipping.

**Phone: (360) 816-0211 • (800) 999-CHEV (2438) • www.chevsofthe40s.com**



**Grille Shell Rubber Pads, cont.**



**595809BE** ..... **37**  
Vertical strip. Grille shell to hood (2 pcs),  
1.278-0.15 ..... **\$115.00 PR** ⚠

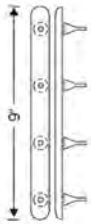

**597562** ..... **38**  
Grille shell to hood.  
1.278-0.15  
..... **\$35.25 PR** ⚠

**Hood Bumpers**



**595304** ..... **37**  
Hood to grille shell (6  
pcs). 8.024-0.3 .....  
**\$7.50 SET** ⚠



**597763** ..... **38-39**  
Hood to grille shell (6  
pcs). 8.024-0.3 .....  
**\$7.50 SET** ⚠



**3653960B** ..... **40-41**  
8 pcs. 8.024-0.3 .....  
**\$10.00 SET** ⚠



**3664645B** ..... **42-48**  
12 pcs. 8.024-0.3 .....  
**\$12.00 SET** ⚠

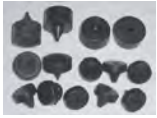

**3688811B** ..... **49-52**  
14 pcs. 8.024-0.2 .....  
**\$14.00 SET** ⚠

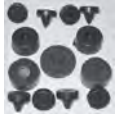

**3704156** ..... **53-54**  
14 pcs. 8.024-0.15 .....  
**\$13.75 SET** ⚠

**Hood Center Strip**



**594940** ..... **37**  
Chrome. 8.015-0.15 ..... **\$468.00 EA** ⚠



**594940SR** ..... **37**  
Car, no holes. Chrome. 8.015-0 .....  
**\$593.00 EA** ⚠

**Hood Center Strip, cont.**



**597480** ..... **38**  
Chrome 8.015-0.15 ..... **\$400.00 EA** ⚠



**597480SR** ..... **38**  
Car, no holes. Chrome. 8.015-0 .....  
**\$544.00 EA** ⚠



**350514** ..... **39**  
No holes. Stainless. 8.015-0.15 .....  
**\$185.50 EA** ⚠

**3701991** ..... **49-52**  
Hood Center Strip 8.055-0  
..... **\$212.50 EA** ⚠

**Hood Center Strip T-Bolt**

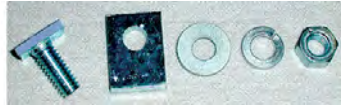

**597466** ..... **37-38**  
Retains rear of hood center strip.  
8.058-0.15 ..... **\$30.00 EA** ⚠

**Adhesives And Sealers**



**01608** ..... **ALL**  
3M plastic & emblem  
adhesive (5 oz. tube).  
8.800-0.15 ..... **\$11.25 EA** ⚠

**Odds And Ends**

Please call for availability on all Odds & Ends parts. Once part is sold, it may no longer be in stock.

**602973U** ..... **38**

Upper hood side panel, used in good condition 8.001-0 ..... **CALL** ⚠

**602974U** ..... **38**

Hood assembly right side 8.001-0 .. **CALL** ⚠

**10721** ..... **41**

Hood, Good Used 19.000-0.4 ..... **\$200.00 EA** ⚠

**3658147U** ..... **41**

Hood Ornament, Used 19.000-0.2 .....  
**\$175.00 EA** ⚠

**3658198U** ..... **41**

Hood moulding Special Deluxe louvered used, needs to be polished and red stripe repainted 8.015-0 ..... **\$75.00 EA** ⚠

**3658259** ..... **41**

Hood side moulding louvre cover left side used very nice polished 8.005-0 .....  
**\$150.00 EA** ⚠

**3658259UL** ..... **41**

Hood side moulding louvre cover w/ inserts left side used 8.005-0 .....  
**\$125.00 EA** ⚠

**3681486U** ..... **41**

Hood side moulding louvre cover used Fleetline 8.005-0 ..... **\$300.00 PR** ⚠

**3689236U** ..... **42-48**

Hood hinge bracket cowl Left 8.015-0.4 .....  
**\$15.00 EA** ⚠

**3681486SM** ..... **46**

Hood side moulding louvre cover used Stylemaster 8.005-0 ..... **\$150.00 PR** ⚠

**609582U** ..... **46**

Hood ornament insert. Blue plastic (Used) 1.265-0.4 ..... **\$30.00 EA** ⚠

**3688253S** ..... **49-50**

Hood Ornament (NOS), Shopworn 1.265-0.2 ..... **\$75.00 EA** ⚠

**3688253U** ..... **49-50**

Hood Ornament, Used 19.000-0.4 .....  
**\$40.00 EA** ⚠

**11050** ..... **49-52**

Hood Latch, Upper (NOS) 8.080-0.4 .....  
**\$85.00 EA** ⚠

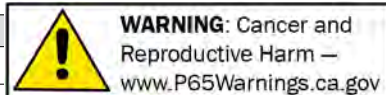

**SECTION 260C  
RESTORATION PARTS**

Note: For fender mouldings see Section 270C.  
Note: For inner fender paint see Paint Section 15C.

**Fender Grilles 1939**



**603837** ..... **39**  
Polished Stainless Steel. No hardware included. 8.168-0 ..... **\$250.00 L&R** ⚠



**603837LS** ..... **39**  
Polished Stainless Steel, Laser Cut. 1.266-0.15 ..... **\$135.00 L&R** ⚠

**Fender Top Ornament**



**3658321** ..... **41**  
Chrome 2.724-0.2 ..... **\$180.00 PR** ⚠



**986981** ..... **54**  
Original accessory. 2.724-0.15 ..... **\$91.00 PR** ⚠

**Fender Top Ornament Rubber Pad**



**3658321A** ..... **41**  
Rubber pads for fender top ornaments (Doesn't fit our ornament) 2.724-0.15 ..... **\$47.75 PR** ⚠

**Fender Ornaments Washer**



**350054** ..... **ALL**  
Hat shaped washer. Known uses: 41 fender top ornaments, washboards & dash trim (16 pcs). 8.040-0.3 ..... **\$12.50 SET** ⚠

**Front Fender Emblem**



**3692093** ..... **49-50**  
Deluxe, script. Comes with retaining hardware. 8.147-0.15 ..... **\$46.75 PR** ⚠



**3695287D** ..... **51**  
Decal, black vinyl, goes in fender moulding. 8.132-0.15 ..... **\$12.50 EA** ⚠

**Rear Fender Emblem**



**4610435** ..... **52**  
"Deluxe", script w/ retaining clips. 8-1/2" long x 1" tall. 12.114-0.15 ..... **\$38.50 PR** ⚠



**4623776** ..... **53-54**  
"Bel Air", script w/ retainers. 12.114-0.15 ..... **\$46.00 EA** ⚠

**Gravel Shields Accessory**



**986001** ..... **42-48**  
Rear fender, stainless (original on 42). 8.214-0 ..... **CALL** ⚠



**986001C** ..... **42-48**  
Rear fender, chrome (original 46-48) w/ moulding hump & nuts. 8.214-0.15 ..... **\$500.00 L&R** ⚠



**986330** ..... **49-50**  
Front fender, stainless. 8.162-0.15 ..... **\$76.00 L&R** ⚠



**986535** ..... **51-52**  
Stainless, front 8.162-0.15 ..... **\$155.00 L&R** ⚠



**4603389A** ..... **53-54**  
Rear fender trim, stainless. 2 door only ..... **\$89.50 L&R** ⚠



**4603389B** ..... **53-54**  
Rear fender, stainless. 2 door only 12.116-0.15 ..... **\$360.75 L&R** ⚠



**986782** ..... **53-54**  
Front fender, stainless. 8.162-0.15 ..... **\$98.25 L&R** ⚠

**Gravel Shields Rubber**

Note: Rubber gravel shields bond directly to fender. See Cement Section 10C.



**609660** ..... **41**  
Rear fender, (rubber) glue on 8.214-0.15 ..... **\$78.75 L&R** ⚠



**3664484** ..... **42-48**  
Rear fender, (rubber) superb! 8.214-0.15 ..... **\$209.75 L&R** ⚠



**3664884A** ..... **42-48**  
Rear fender, (rubber) glue on 8.214-0.15 ..... **\$71.00 L&R** ⚠



**4561819** ..... **49-52**  
(rubber) 49-50 2-door & 49-52 Sedan Delivery glue on. 12.116-0.15 ..... **\$65.00 L&R** ⚠

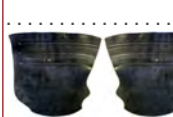

**4589005** ..... **51-52**  
(rubber) 2-door exc Sedan Delivery, glue on 12.116-0.15 ..... **\$75.25 L&R** ⚠



**Stainless Gravel Shields Bolt**



**4603389B** ..... **53-54**  
Gravel shield, 2-door models 12.114-0.3 ..... **\$12.50 SET** ⚠

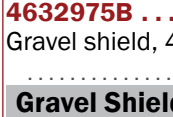

**4632975B** ..... **53-54**  
Gravel shield, 4-door models 12.114-0.3 ..... **\$12.50 SET** ⚠

**Gravel Shield Clips**



**4601265** ..... **53-54**  
Rear fender (10 pcs). Superior. 12.114-0.15 ..... **\$29.25 SET** ⚠

**Fender Washboards Washer**



**350054** ..... **ALL**  
Hat shaped washer. Known uses: 41 fender top ornaments, washboards & dash trim (16 pcs). 8.040-0.3 ..... **\$12.50 SET** ⚠

trim (16 pcs). 8.040-0.3 ..... **\$12.50 SET** ⚠

**Odds And Ends**

Please call for availability on all Odds & Ends parts. Once part is sold, it may no longer be in stock.

**3658321U** ..... **41**  
Fender top ornament (Used). 2.724-0.4 ..... **\$50.00 EA** ⚠

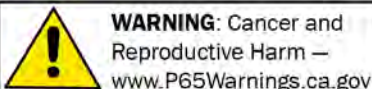

Chemicals shipped domestic ground only (Lower 48 states only). No international shipping.

Phone: (360) 816-0211 • (800) 999-CHEV (2438) • www.chevsofthe40s.com



**Perspective: Standing in engine compartment and looking out at Passenger Side Fender**

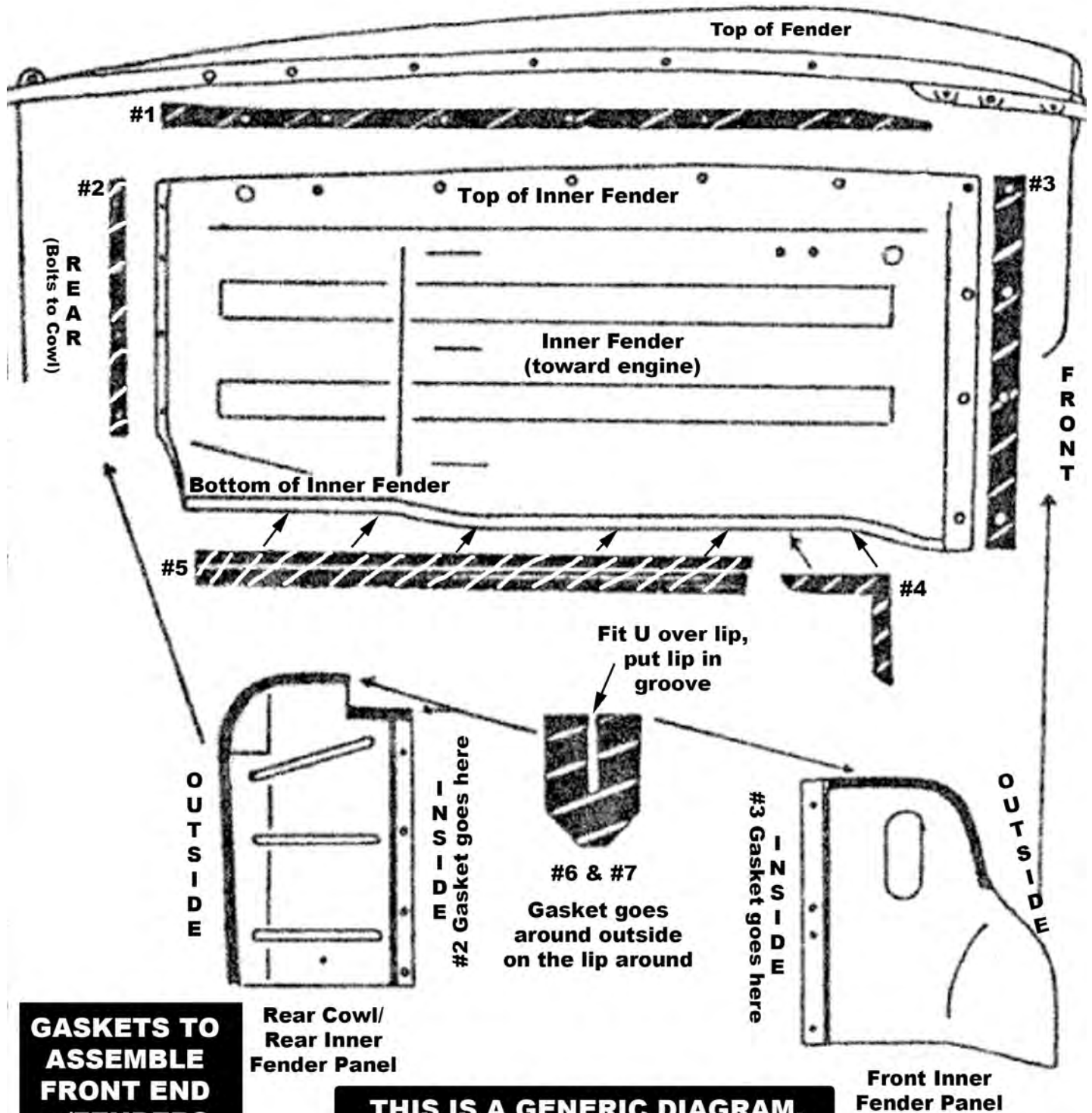

**GASKETS TO ASSEMBLE FRONT END w/FENDERS**  
 GASKETS shown in BLACK w/STRIPES (numbered #1-#7)

Rear Cowl/  
 Rear Inner  
 Fender Panel

**THIS IS A GENERIC DIAGRAM, APPLIES TO 1937-54, SO THE SHAPES MAY BE DIFFERENT.**

Front Inner  
 Fender Panel

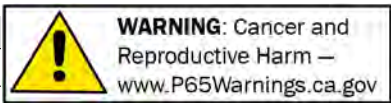

**SECTION 270C  
RESTORATION PARTS**

Note: Fender Ornaments see Section 260C.

**Fender Front (Fiberglass)**



- 602635** ..... **37-38**
- Left. 8.130 -0.15 ..... **\$604.00 EA** ⚠
- 602636** ..... **37-38**
- Right. 8.130 -0.15 ..... **\$604.00 EA** ⚠
- 350237** ..... **39**
- Left. 8.130 -0.15 ..... **\$679.25 EA** ⚠
- 350238** ..... **39**
- Right. 8.130 -0.15 ..... **\$679.25 EA** ⚠
- 3652971** ..... **40**
- Left. 8.130 -0.15 ..... **\$568.00 EA** ⚠
- 3652973** ..... **40**
- Right. 8.130 -0.15 ..... **\$568.00 EA** ⚠
- 3684117** ..... **42-48**
- Left. 8.130 -0 ..... **CALL** ⚠
- 3684118** ..... **42-48**
- Right. 8.130 -0 ..... **CALL** ⚠

**Fender Front Extension (Fiberglass)**



- 3663517F** ..... **42-48**
- Left. 8.131 -0 ..... **CALL** ⚠
- 3663518F** ..... **42-48**
- Right. 8.131 -0 ..... **CALL** ⚠

**Fender Rear (Fiberglass)**



- 597275** ..... **37-38**
- Left. 8.203 -0.15 ..... **\$479.00 EA** ⚠
- 597275W** ..... **37-38**
- Left, 2" wider. 8.203 -0.15 ..... **\$493.50 EA** ⚠
- 597280** ..... **37-38**
- Right. 8.203 -0.15 ..... **\$479.00 EA** ⚠
- 597280W** ..... **37-38**
- Right, 2" wider. 8.203 -0.15 ..... **\$493.50 EA** ⚠
- 599341** ..... **39**
- Left. 8.203 -0.15 ..... **\$493.50 EA** ⚠
- 599341W** ..... **39**
- Left, 2" wider. 8.203 -0.15 ..... **\$493.50 EA** ⚠
- 599364** ..... **39**
- Right. 8.203 -0.15 ..... **\$493.50 EA** ⚠

**Fender Rear (Fiberglass), cont.**

- 599364W** ..... **39**
- Right, 2" wider. 8.203 -0.15 ..... **\$479.50 EA** ⚠
- 604627** ..... **40**
- Left. 8.203 -0.15 ..... **\$524.50 EA** ⚠
- 604627W** ..... **40**
- Left, 2" wider. 8.203 -0.15 ..... **\$493.50 EA** ⚠
- 604628** ..... **40**
- Right. 8.203 -0.15 ..... **\$524.50 EA** ⚠
- 604628W** ..... **40**
- Right, 2" wider. 8.203 -0.15 ..... **\$493.50 EA** ⚠
- 609657** ..... **41-48**
- Left. 8.203 -0.15 ..... **\$493.50 EA** ⚠
- 609657W** ..... **41-48**
- Left, 2" wider. 8.203 -0.15 ..... **\$493.50 EA** ⚠
- 609658** ..... **41-48**
- Right. 8.203 -0.15 ..... **\$493.50 EA** ⚠
- 609658W** ..... **41-48**
- Right, 2" wider. 8.203 -0.15 ..... **\$493.50 EA** ⚠

**Fender Panel Inner (Fiberglass)**



- 594221B** ..... **37-38**
- Front. 8.153 -0.15 ..... **\$392.00 L&R** ⚠



- 350609B** ..... **39**
- Front. 8.153 -0 ..... **CALL** ⚠
- 3658787F** ..... **41**
- Left. 8.153 -0 ..... **CALL** ⚠
- 3658788F** ..... **41**
- Right. 8.153 -0 ..... **CALL** ⚠
- 3664301F** ..... **42-48**
- Left. 8.153 -0 ..... **CALL** ⚠
- 3664302F** ..... **42-48**
- Right. 8.153 -0 ..... **CALL** ⚠

**Core Support Panel (Fiberglass)**



- 3653849F** ..... **40**
- Front left, fiberglass. 8.153 -0 ..... **CALL** ⚠
- 3653850F** ..... **40**
- Front right, fiberglass. 8.153 -0 ..... **CALL** ⚠

**Inner Baffle (Fiberglass)**



- 3664113F** ..... **42-48**
- Behind headlight bucket, left. 8.164 -0 ..... **CALL** ⚠



- 3664114F** ..... **42-48**
- Behind headlight bucket, right. 8.164 -0 ..... **CALL** ⚠

**Fender Brace**



- 594203** ..... **37**
- Rear, steel. 8.212 -0.15 ..... **\$19.75 EA** ⚠
- 594203L** ..... **37**
- Car, fender brace. Rear, for 2 in. widened fenders, 15-1/4" long. 8.212 -0.3 ..... **\$15.50 EA** ⚠
- 594203S** ..... **37**
- Rear, stainless steel. 12" long, with bolts and nuts. 8.212 -0 ..... **\$89.00 PR** ⚠
- 597279** ..... **38**
- Rear, steel. 8.212 -0.3 ..... **\$23.00 EA** ⚠
- 597279L** ..... **38**
- Car rear, steel for 2" widened fenders. 8.212 -0.4 ..... **\$16.50 EA** ⚠
- 350609** ..... **39**
- Front, steel. 8.144 -0.15 ..... **\$17.25 EA** ⚠
- 598238** ..... **39**
- Rear, steel. 8.212 -0.15 ..... **\$14.50 EA** ⚠
- 598238L** ..... **39**
- Car rear, steel for 2" widened fenders. 8.212 -0.3 ..... **\$16.50 EA** ⚠
- 3652627** ..... **40**
- Rear, steel. 8.212 -0.15 ..... **\$13.75 EA** ⚠
- 3652627L** ..... **40**
- Car rear, steel for 2" widened fenders. 8.212 -0.2 ..... **\$16.50 EA** ⚠
- 3653643** ..... **40**
- Front, steel. 8.144 -0.2 ..... **\$17.25 EA** ⚠
- 3658019** ..... **41-48**
- Rear, steel. 8.212 -0.3 ..... **\$32.25 EA** ⚠
- 3658019L** ..... **41-48**
- Car rear, steel for 2" widened fenders. 8.212 -0.4 ..... **\$15.50 EA** ⚠
- 3664045** ..... **41-48**
- Front, steel. 8.144 -0.2 ..... **\$16.50 EA** ⚠



- 3700393A** ..... **49-52**
- Die-stamped. Fender brace for rear of front left fender. Made in the USA. 8.153 -0.15 ..... **\$61.75 EA** ⚠



- 3700394A** ..... **49-52**
- Die-stamped. Fender brace for rear of front right fender. Made in the USA. 8.153 -0.15 ..... **\$61.75 EA** ⚠

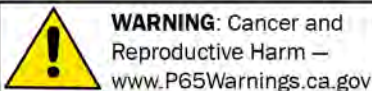

Chemicals shipped domestic ground only (Lower 48 states only). No international shipping.

Phone: (360) 816-0211 • (800) 999-CHEV (2438) • www.chevsofthe40s.com



**Fender Brace, cont.**

 **3705136A** .....53-54  
Die-stamped. Fender brace for rear of front right fender. Supports fender, bolts to the bottom of the body. 8.153 -0.15 ..... **\$50.00 EA** ⚠

 **3707847A** .....53-54  
Die-stamped. Fender brace for rear of front left fender. Supports the fender, bolts in the bottom of the body. 8.153 -0.15 .. **\$50.00 EA** ⚠

**Caged Nuts**

 **4034101** .....31-48  
Mount in body for fender bolts (4 pcs).  
12.751 -0.15 ..... **\$7.00 SET** ⚠

**4034101B** .....31-48  
Mount in body for fender bolts (4 pcs).  
With Bolts 12.751 -0 ..... **\$12.00 SET** ⚠

**Gaskets -Front End Assembly**

Note: Complete gasket kits include U-Channel sponge seal (part #3701900) plus all gaskets & seals needed to assemble front end.



**3654148B** .....37-38  
Kit to assemble front end w/ fenders  
8.153 -0.1 ..... **\$53.50 SET** ⚠

**3654036B** .....40  
Kit to assemble front end w/ fenders  
8.153 -0.3 ..... **\$63.50 SET** ⚠

**3659114B** .....41  
Kit to assemble front end w/ fenders (includes #3658853) 8.153 -0.2 ..... **\$79.95 SET** ⚠

**3664302B** .....42-48  
Kit to assemble front end w/ fenders (includes #3665695) 8.153 -0.2 ..... **\$74.25 SET** ⚠

**3688520B** .....49-50  
Kit to assemble front end w/ fenders  
8.153 -0.25 ..... **\$62.50 SET** ⚠

**3694936B** .....51-52  
Kit to assemble front end w/ fenders  
8.153 -0.2 ..... **\$44.00 SET** ⚠

**3701906B** .....53  
Kit to assemble front end w/ fenders  
8.153 -0.3 ..... **\$44.00 SET** ⚠

**3705108B** .....54  
Kit to assemble front end w/ fenders  
8.153 -0.3 ..... **\$68.00 SET** ⚠

**Fender To Cowl Moulded Rubber**



**3658853** .....41  
Anti-squeak gasket. Fits rear of front fender to cowl 8.161 -0.4 ..... **\$15.00 PR** ⚠

**Fender U channel Sponge Seal**

 **3701900** .....41-60  
Inner fender to frame  
8.205 -0.3 ..... **\$19.00 PR** ⚠



**3701900BULK^** .....ALL  
Sold by the inch 8.205 -0.3 ..... **\$0.25 IN** ⚠

**Fender L Channel sponge seal**

**3702000BULK^** .....ALL  
Sold by the inch 8.205 -0.4 ..... **\$0.25 IN** ⚠

**Fender Gaskets**



**3664697** .....42-48  
Front fender extension to door 8.133 -0.4 ..... **\$30.75 PR** ⚠

**Fender Seal (Channel Shaped)**

 **3665695** .....42-48  
Over metal filler strip, cowl to top rear of front fender 8.165 -0.4 ..... **\$37.50 PR** ⚠

**Fender Seal**

 **3690751** .....49-52  
Door to hinge pillar seal. Die cut sheet. Use w/ weatherstrip-#3692045B or  
#4606455B 8.164 -0.4 ..... **\$40.00 SET** ⚠

**Fender Welting**

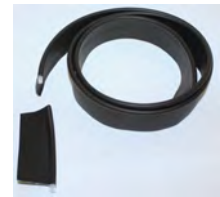

**601726** .....ALL  
Black 1/4in. x 1-3/16in. 37-48 rear fenders use approx 15 ft. r-0 ..... **\$1.00 FT** ⚠



**601726C** .....ALL  
Chrome mylar (1-1/4" x 3/16" ). 8.205 -0 ..... **\$2.25 FT** ⚠

**Washers Rubber**

 **3688003** .....ALL  
Thin cushion for flat washers. Seals & prevents squeaks, etc (48 pcs) 8.206 -0.4 ..... **\$172.00 SET** ⚠

**Fender Marker (Guide)**

 **985134** .....37-54  
Illuminated. Clamps to front fender, chrome plated. Milky colored top w/ clear lens & stainless fin. 15.5" tall -0.15 ..... **\$100.50 PR** ⚠

 **985134BULB** .....ALL  
Replacement bulb. 3 watt, 12 volt threaded base -0.15 ..... **\$1.25 EA** ⚠

 **985135** .....ALL  
lighted Fender Guide, Chrome With Green, Red, Blue Or Amber  
Inserts -0.15 ..... **\$65.00 PR** ⚠

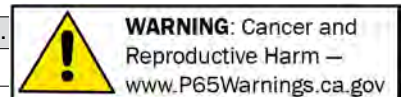

**Curb Feelers**



**985289A** .....ALL  
 Chrome flex wire, clamp on vintage accessory helps prevent wheel & fender damage by creating a noticeable scraping sound when vehicle is too close to the curb.

8.214 -0.15 ..... **\$16.75 PR** ⚠



**985289B** .....ALL  
 Chrome plated, vintage clamp on accessory helps prevent wheel & fender damage by creating a noticeable scraping sound when vehicle is too close to the curb. 8.214 -0.15

..... **\$15.25 PR** ⚠

**Fender Moulding**



**3693873R** .....49-50  
 Front fender reproduction 8.132 -0.15

**\$55.25 EA** ⚠

**4561289** .....49-52

Upper belt moulding. Right side. Fits 4-door. NOS 12.112 -0.15

**\$75.00 EA** ⚠

**4561289U** .....49-52

Upper belt moulding. Right side. Fits 4-door. Used in good condition 12.112 -0.15

**\$60.00 EA** ⚠

**4561290** .....49-52

Upper belt moulding. Left side. Fits 4-door Nos -0.15

**\$75.00 EA** ⚠

**4561290U** .....49-52

Upper belt moulding. Left side. Fits 4-door used in good condition -0.15

**\$60.00 EA** ⚠

**4561291** .....49-52

Upper belt moulding. Nos Left side. Fits 2 door (Exc HTP, CVT and SDL) -0.15

**\$99.00 EA** ⚠

**4561292** .....49-52

Upper belt moulding. Nos Left side. Fits 2 door (Exc HTP, CVT and SDL) -0.15

**\$99.00 EA** ⚠

**4561339** .....49-52

Upper belt moulding. Right side. Fits 4-door. Nos -0.15

..... **\$75.00 EA** ⚠

**Fender Moulding, cont.**

**4561339U** .....49-52

Upper belt moulding. Right side. Fits 4-door. Used in good condition -0.15

**\$60.00 EA** ⚠

**4561340** .....49-52

Upper belt moulding. Left side. Fits 4-door. Nos -0.15

**\$75.00 EA** ⚠

**4561340U** .....49-52

Upper belt moulding. Left side. Fits 4-door. Used in good condition -0.15

**\$60.00 EA** ⚠

**3700036** .....52

Moulding, Nos Front Fender -0

**CALL** ⚠

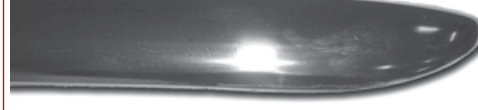

**3698359** .....53-54

Left 8.132 -0.15

**\$54.00 EA** ⚠



**3698360** .....53-54

Right 8.132 -0.15

**\$54.00 EA** ⚠

**Fender Front And Rear Moulding Clips Fleetline**



8.133 -0.15

**4114412C** .....42-48

Clip-bolt set for Fleetline fender skirt mouldings (set for 1 car) 8.133 -0

**\$15.75 SET** ⚠

**Fender Front Moulding Clips**



**3667254** .....42-48

Bolt for front fender extension moulding (cap on door). Fits

Fleetline (uses 6 per side). 6 Piece Set.

8.133 -0.15

**\$4.50 SET** ⚠

**4114412** .....42-48

Clip-set for front fender extension moulding (cap on door). Fits

Fleetline (9 per side) (9 pcs) 8.133 -0

**CALL** ⚠

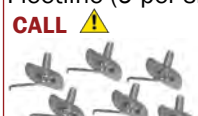

**3700044** .....49-50

Clip-bolt set does one front fender moulding (6 pcs) 8.309 -0.2

**\$7.50 SET** ⚠

**Fender Front Moulding Clips, cont.**



**3700044** .....52-54

Clip-bolt set does one front fender moulding (6 pcs) 8.133 -0.15

**\$4.50 SET** ⚠

**Fender Rear And Quarter Panel Clips**

**3667524** .....42-48

Bolts for rear fender moulding. Fleetline (uses 6 per fender) (6 piece set)

8.133 -0.15

**\$4.50 SET** ⚠

**4114412A** .....42-48

Clip-bolt set for rear fender moulding. Fits Fleetline (15 per fender) (15 piece set)

8.133 -0.15

**\$9.75 SET** ⚠

**4614937** .....52

For 2 quarter panels. 12.116 -0.15

**\$9.00 SET** ⚠

**4603301B** .....53-54  
 For two quarter panels, Bel Air 2-door Sedan, Hardtop, Convertible

12.116 -0.15

**\$15.00 SET** ⚠

**4603305B** .....53-54

For two quarter panels, Bel Air 4-door, 4-door Wagon 12.116 -0.3

**\$22.00 SET** ⚠

**4603307B** .....53-54

For 2 quarter panels. Fits 210 4-door Sedan, 4-door Wagon 12.116 -0.3

**\$22.00 SET** ⚠

**4603309B** .....53-54

For two quarter panels, 210 2-door Sedan, Hardtop, Convertible

12.116 -0.15

**\$12.00 SET** ⚠

**Fender Mount Bolt And Washer Set**

Note: Would you like a new bolt kit for your 53-54 car? If you provide us with the original set as a sample, we will ship you the new set for your trouble.



**3651239B** .....37-39

Front & rear fenders, original style

8.206 -0.3

**\$32.00 SET** ⚠

**3651240B** .....40

Front & rear fenders, original style

8.206 -0.15

**\$40.00 SET** ⚠

**3651216** .....40-48

Rear fender (52 pcs). 8.206 -0.15

**\$10.75 SET** ⚠

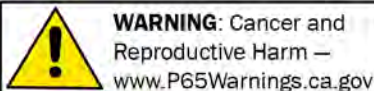

**WARNING: Cancer and Reproductive Harm** —  
[www.P65Warnings.ca.gov](http://www.P65Warnings.ca.gov)

Chemicals shipped domestic ground only (Lower 48 states only). No international shipping.

Phone: (360) 816-0211 • (800) 999-CHEV (2438) • [www.chevsofthe40s.com](http://www.chevsofthe40s.com)



**Fender Mount Bolt And Washer Set, cont.**

- 3651241B** ..... **41**  
Front & rear fenders, original style  
8.206 -0.3 ..... **\$32.00 SET** ⚠
- 3651242B** ..... **42-48**  
Front & rear fenders, original style  
8.206 -0.3 ..... **\$30.00 SET** ⚠
- 3651243B** ..... **49-52**  
Front fenders, original style. 8.206 -0.15  
**\$28.00 SET** ⚠

**Washer Fender Ornaments**

-  **350054** ..... **ALL**  
Hat shaped washer.  
Known uses: 41 fender  
top ornaments,  
washboards & dash  
trim (16 pcs). 8.040 -0.3 ..... **\$12.50 SET** ⚠

**Headlight Wire Grommet**

-  **3673139** ..... **39-54**  
Inner panel for  
headlight, park light  
pigtailes (41 uses 2 pr,  
others use 1 pr)  
9.775 -0.4 ..... **\$3.50 PR** ⚠

**Air Duct Baffle**

-  **3688772** ..... **49-52**  
Below battery. Right  
side. 12.803 -0.3 .....  
**\$44.75 EA** ⚠

**Rumble Seat Step**

-  **369497R** ..... **29-38**  
Metal plate w/ threaded  
shaft and rubber pad  
without an emblem  
9.470 -0.15 .....  
**\$56.00 EA** ⚠

-  **4076136A** ..... **37**  
Rubber pad for bracket  
15.198 -0.15 .....  
**\$11.50 EA** ⚠

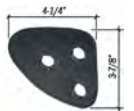
-  **597556A** ..... **37-38**  
Rubber pad for bracket  
9.470 -0.15 .....  
**\$12.75 EA** ⚠

**Rumble Seat Lid Rubber Corners**

-  **4062183A** ..... **35-38**  
These are the rubber  
corners for the rumble  
seat lid. 15.208 -0  
..... **CALL** ⚠

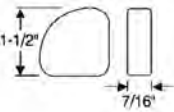
-  **4074031** ..... **37-38**  
Rubber corners for the  
rumble seat lid to  
protect the lid and your  
passengers. 12.212 -0.15  
..... **\$60.00 PR** ⚠

**Odds And Ends**

Please call for availability on all Odds & Ends parts. Once part is sold, it may no longer be in stock.

- 609660U** ..... **41**  
Gravel Shield-rubber-left Only (NOS)  
21.000 -0.4 ..... **\$50.00 EA** ⚠



- 3664884N** ..... **42-48**  
Gravel Shields (nos)  
Take Offs 21.000 -0.4 ..  
**\$50.00 PR** ⚠

- 3664884NL** ..... **42-48**  
Gravel Shield-nos Left-shelf Worn  
8.214 -0.4 ..... **\$25.00 LH** ⚠

- 3690632** ..... **49-50**  
Front fender right used in good condition  
8.130 -0.4 ..... **\$300.00 EA** ⚠
- 986330U** ..... **49-50**  
Accy. Gravel Shields, Front Fender 8.162 -0.4  
..... **\$35.00 PR** ⚠

- 12702** ..... **51-52**  
Fender Skirt, Used, Left Side 23.000 -0.4  
**\$60.00 EA** ⚠

- 3692857** ..... **51-52**  
Fender Skirt Lock Lever Guide, Front  
23.000 -0.4 ..... **\$15.00 EA** ⚠

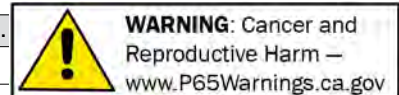

**SECTION 280C  
RESTORATION PARTS**

**Fender Skirts**

NOTE: Seals are included in all Fender Skirt sets.



**604503A** .....**37-48**  
Fabricated teardrop style. Steel (20ga.). Includes rubber seals. 8.175 -0 ..... **CALL** ⚠



**985641** .....**37-48**  
Superb die-stamped production of 1940 original steel tear drop skirts. Includes s rubber seals. These were an original factory accessory for 1940 Packard and Ford

These will also fit:

- 1938-1940 Ford
- 1937-1940 Plymouth
- 1937-1940 Dodge
- 1937-1940 Desoto
- 1937-1940 Cadillac
- 1939-1940 Studebaker
- 1937-1947 Oldsmobile
- 1939-1947 Packard
- 1937-1941 6 & 8 Standard Pontiac



**985873** .....**41-48**  
Exc Fleetline. Nice repro. Original 42-48. Includes rubber seals. 8.175 -0.15 ..... **\$355.25 L&R** ⚠



**985874** .....**41-48**  
Fleetline w/ mouldings. Nice repro. Original 42-48. Includes rubber seals. 8.175 -0.15 ..... **\$454.75 L&R** ⚠

**Fender Skirts, cont.**



**3693333** .....**49-50**  
Die stamped. Superb reproduction. Includes rubber seals. 8.175 -0.15 ..... **\$258.00 L&R** ⚠



**3695982** .....**51-52**  
Die stamped. Superb reproduction. Includes rubber seals. 8.175 -0.15 ..... **\$258.00 L&R** ⚠



**3705104** .....**53-54**  
Die stamped. Superb reproduction. Includes rubber seals. 8.175 -0.15 ..... **\$257.25 PR** ⚠

**Fender Skirt Mouldings**



**985874B** .....**41-48**  
Fleetline for original 42-48 skirts (6 pcs) 8.175 -0.15 ..... **\$76.75 SET** ⚠

**Fender Skirt Trim (Bloomers)**



**3705105** .....**49-50**  
Lower, stainless steel w/ mounting hardware. Fits 2 Door 8.175 -0.15 ..... **\$430.00 PR** ⚠

**3705106** .....**49-50**  
Lower, stainless steel w/ mounting hardware. Fits 4 Door. 8.175 -0 ..... **CALL** ⚠



**3705103** .....**53-54**  
Lower, stainless steel w/ mounting hardware. Fits Bel Air & 210. 8.175 -0.15 ..... **\$170.25 PR** ⚠

**Fender Skirt Retainer**



**3699931** .....**49-54**  
On body 8.176 -0.15 ..... **\$16.50 SET** ⚠

**Fender Skirt Seal**



**601620** .....**34-39**  
8.177 -0.15 ..... **\$81.75 SET** ⚠



**604517** .....**40-41**  
Fender skirt to rear fender (10 ft) 8.177 -0.15 ..... **\$19.50 PR** ⚠



**606382** .....**42-48**  
Fender skirt to rear fender (9 ft) 8.177 -0 ..... **CALL** ⚠



**3695672** .....**49-54**  
Fender skirt to rear fender (10 ft) 8.177 -0.15 ..... **\$12.50 SET** ⚠

**Odds And Ends**

Please call for availability on all Odds & Ends parts. Once part is sold, it may no longer be in stock.

**12660** .....**49-50**  
Fender Skirts, Used 8.175 -0.15 ..... **\$200.00 PR** ⚠

**12701** .....**51-52**  
Fender Skirts (Used) 23.000 -0.15 ..... **\$200.00 PR** ⚠

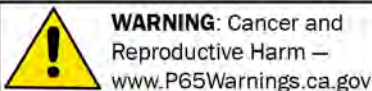

**WARNING: Cancer and Reproductive Harm** — www.P65Warnings.ca.gov

Chemicals shipped domestic ground only (Lower 48 states only). No international shipping.

**Phone: (360) 816-0211 • (800) 999-CHEV (2438) • www.chevsofthe40s.com**



**SECTION 290C  
RESTORATION PARTS**

Note: Contact cement to adhere any rubber to metal see Section 12C.

Note: Running Boards and Rocker Panels can be found in Section 295C.

**Sill Plate Screws**



**4082059A** ..... **.37-39**  
Stainless steel screws for aluminum & rubber sill plates. Complete for 2 Door 11.175 -0.3 ..... **\$3.50 SET** ⚠

**4147880A** ..... **40-54**  
Stainless steel screws for aluminum & rubber sill plates. 2 door (specify year when ordering). 11.175 -0 ..... starting at **\$8.50 SET** ⚠

**4147880B** ..... **40-54**  
Stainless steel screws for aluminum & rubber sill plates. Complete for 4 Door (specify year when ordering). 11.175 -0 starting at **\$8.50 SET** ⚠

**Sill Plates**



**4082059** ..... **.37-39**  
Aluminum, for 2 doors. Use 2 pairs for 4 doors. (trim to fit). 11.175 -0.2 ..... **\$200.25 PR** ⚠



**4102273** ..... **40**  
Aluminum, Master 85, Deluxe, Coupe, 2-door 11.175 -0.15 ..... **\$235.00 PR** ⚠



**4102274** ..... **40**  
Aluminum, Special Deluxe, Cabriolet, Coupe & 2-door 11.175 -0.15 ..... **\$225.25 SET** ⚠

**Sill Plates, cont.**



**4102276** ..... **40**  
Aluminum, Sedan Delivery 11.175 -0.15 **\$225.00 PR** ⚠



**4102277** ..... **40**  
Aluminum, Special Deluxe, 4-door (6 pcs) 11.175 -0.15 ..... **\$275.00 SET** ⚠



**4102278** ..... **40**  
Aluminum, Master 85, Deluxe, 4-door (4 pcs) 11.175 -0.15 ..... **\$275.00 SET** ⚠



**4105744** ..... **40**  
Filler for gap between front & rear carpet at seat end, all Special Deluxe 11.175 -0.15 ..... **\$60.00 PR** ⚠



**4114762** ..... **41-48**  
Aluminum, 2-door exc Aero & Cabriolet 11.175 -0.15 ..... **CALL** ⚠



**4114765** ..... **41-48**  
Aluminum, Sedan Delivery 11.175 -0.15 **\$200.00 PR** ⚠



**4114766** ..... **41-48**  
Aluminum, 4-door exc Fleetline 11.175 -0.15 ..... **\$225.25 SET** ⚠

**Sill Plates, cont.**



**4121529** ..... **41-48**  
Aluminum, Fleetline 4-door 11.175 -0.15 **\$225.25 SET** ⚠



**4132244** ..... **41-48**  
Aluminum, Cabriolet 11.175 -0.15 ..... **\$225.00 PR** ⚠



**4132090** ..... **42-48**  
Aluminum, Aero Fleetline 2-door 11.175 -0.15 ..... **\$199.00 PR** ⚠



**4114763** ..... **46-48**  
Aluminum, Wagon 11.175 -0.15 ..... **\$265.00 SET** ⚠

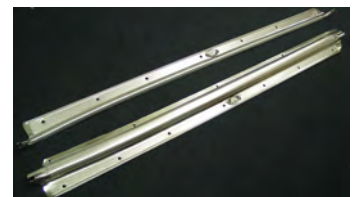

**4584354** ..... **49-52**  
Aluminum. Fits 2-door (exc. Convertible & Hardtop). Includes Fisher emblem & mounting screws. 11.175 -0.15 ..... **\$200.00 PR** ⚠



**4584357** ..... **49-52**  
Aluminum, 4-door & Wagon 11.175 -0.15 ..... **\$269.50 SET** ⚠

# Section 290C: Sill Plates, Running Board Gaskets, Step Plates, Rocker Panel Mouldings & Fasteners

## Sill Plates, cont.



**4584358** ..... **.49-52**  
 Aluminum, Sedan Delivery 11.175 -0.15  
**\$250.50 PR** ⚠



**4603327** ..... **.49-52**  
 Aluminum, Convertible, Hardtop 11.175 -0.15  
 ..... **\$190.00 PR** ⚠



**4602017** ..... **.53-54**  
 Aluminum, 4-door & Wagon 11.175 -0.15  
 ..... **\$267.75 SET** ⚠



**4602018** ..... **.53-54**  
 Aluminum, Sedan Delivery 11.175 -0  
**\$225.00 PR** ⚠



**4602021** ..... **.53-54**  
 Aluminum. Fits 2-door exc Convertible

\*\*NOTE: These parts come with a protective removable blue plastic film (to help prevent scratches), once you remove it—the parts are regular silver colored aluminum. 11.175 -0.15  
**\$201.25 PR** ⚠



**4602352** ..... **.53-54**  
 Aluminum. Fits convertible 11.175 -0.15  
**\$200.00 PR** ⚠

## Sill Plates Emblem



**PLATE08** ..... **.49-54**  
 Body by Fisher 19.400 -0.15 .. **\$4.00 EA** ⚠

## Sill Plates Outer Rubber



**4147880** ..... **.41-48**  
 W/ metal back & screw holes for 2-door  
 exc Aero 15.290 -0.15 ... **\$454.25 PR** ⚠



**4147880E** ..... **.41-48**  
 W/ metal back & screw holes for 2-door  
 exc Aero 15.290 -0.15 ... **\$595.25 PR** ⚠



**4157876** ..... **.41-48**  
 No metal backs, trim to fit, Fleetline 4-door  
 15.290 -0.15 ..... **\$383.25 SET** ⚠



**4550508** ..... **.41-48**  
 Fronts, w/ metal back & screw holes for  
 Sedan Delivery, Wagon, 4-door (exc  
 Fleetline) 15.290 -0.15 .. **\$645.00 PR** ⚠

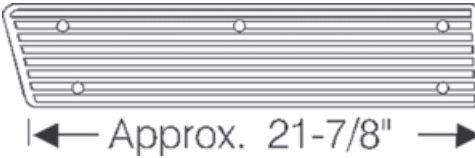

**4550510** ..... **.41-48**  
 Rears, w/ metal back & screw holes for  
 Wagon, 4-door (exc Fleetline) 15.290 -0.15  
 ..... **\$523.00 PR** ⚠

## Sill Plates Outer Rubber, cont.

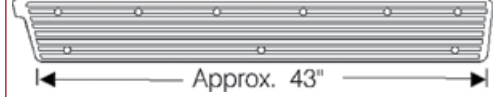

**4147886** ..... **.42-48**  
 W/ metal back, Fleetline 2-door  
 15.290 -0.15 ..... **\$616.00 PR** ⚠

## Anti Squeak Gasket

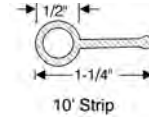

**350645** ..... **.33-39**  
 (Beaded) running board  
 to apron (10 ft)  
 8.322 -0.15 .....  
**\$22.50 SET** ⚠

## Running Board Mat



**597625** ..... **.37-38**  
 Steel back w/ twist tab for original running  
 boards only 8.316 -0 ..... **\$601.75 L&R** ⚠



**597626** ..... **.37-38**  
 For smooth running boards. Rubber only.  
 8.316 -0 ..... **\$476.50 L&R** ⚠



**350271** ..... **.39**  
 Steel back w/ twist tab (super) 8.316 -0  
 ..... **\$605.00 L&R** ⚠

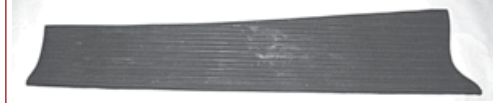

**350271A** ..... **.39**  
 For smooth running boards. Rubber only.  
 8.316 -0.15 ..... **\$438.75 L&R** ⚠



**3653587** ..... **.40**  
 Rubber only 8.299 -0 ..... **\$497.25 L&R** ⚠

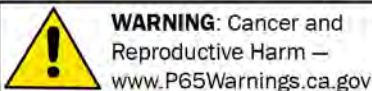

Chemicals shipped domestic ground only (Lower 48 states only). No international shipping.

Phone: (360) 816-0211 • (800) 999-CHEV (2438) • www.chevsofthe40s.com



# Section 290C: Sill Plates, Running Board Gaskets, Step Plates, Rocker Panel Mouldings & Fasteners

## Running Board Mounting Hardware

Note: Running board brackets see section 295C



**365668B.....37-39**  
Complete mounting hardware for running board 8.299-0.4  
.....  
**\$6.00 SET** ⚠

## Running Board Mouldings

Oversize shipping charges apply. Please call for rate.



**593614C.....34-38**  
77-3/4" X 3/4" replacement style w/ clips. Stainless. 8.309-0.1  
.....  
**\$425.00 PR** ⚠



**593392.....39**  
Replacement style stainless (includes clips). 75-3/8" X 1/2". 8.304-0.15  
.....  
**\$425.00 PR** ⚠

**3653729B.....40**  
68-3/8" x 1" w/ clips 8.309-0.3  
.....  
**\$425.00 PR** ⚠

## 1934-40 Running Board Moulding Clips And Bolts

Note: Running board mouldings have been reproduced in different widths. Choose clips based on the size of your mouldings.

**370044.....34-38**  
Running Board Moulding Bolts (4 pieces). 8.309-0.2  
.....  
**\$4.00 SET** ⚠



**593617B.....34-38**  
Original running board moulding. Fastener set does both sides. 8.309-0  
.....  
**CALL** ⚠



**350613.....39**  
20 pcs. Does both sides. 8.304-0.15  
.....  
**\$6.00 SET** ⚠

## 1934-40 Running Board Moulding Clips And Bolts, cont.



**350613B.....39**  
Running board mouldings. Fastener set does both sides. 8.304-0.3  
.....  
**\$20.00 SET** ⚠



**3664679.....39**  
4 per car (4 pcs). (Use with 350613) 8.309-0.15  
.....  
**\$2.00 SET** ⚠



**3653730.....40**  
Running clips - for use with 1-1/4" running board mouldings. Deluxe. (Use with

3664679) 8.309-0.15  
.....  
**\$2.25 EA** ⚠  
**3653730B.....40**  
For moulding 1-1/4in. wide. Fastener set of clips & bolts, does both sides. 8.309-0.15  
.....  
**\$48.00 SET** ⚠

**3653730C.....40**  
For mouldings 1in. wide. Fastener set does both sides. 8.309-0.15  
.....  
**\$18.00 SET** ⚠

**370044.....40**  
Running Board Moulding Bolts (4 Per Car) 4pcs. 8.309-0.2  
.....  
**\$4.00 SET** ⚠

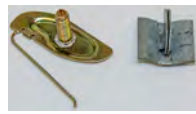

**593617C.....40**  
Running Board Moulding Clips & Bolts. For moulding 7/8in. wide. Fastener set does both sides. 8.309-0  
.....  
**CALL** ⚠

## Rocker Mouldings

Oversize shipping charges apply. Please call for rate.



**3658690N.....41**  
Shelf worn (NOS). 8.304-0.4  
.....  
**CALL** ⚠

**3681636.....42-48**  
Rocker Mouldings - Stainless 8.304-0  
.....  
**CALL** ⚠



**3688947.....49-52**  
Rocker mouldings 8.304-0.15  
.....  
**\$199.00 PR** ⚠

## Rocker Mouldings, cont.



**3698437.....53-54**  
Rocker mouldings 8.304-0.15  
.....  
**\$157.50 PR** ⚠

## 1941-48 Rocker Moulding Clips And Bolts

**3658565B.....41**  
Clips & Bolts (does 2) 8.309-0  
.....  
**\$74.00 SET** ⚠  
**3688845.....41**  
6 per car 8.309-0.3  
.....  
**\$7.50 SET** ⚠



**3682035.....42-48**  
Long bolt. 2 per car (2 pcs) 8.309-0.15  
.....  
**\$3.00 SET** ⚠

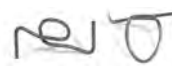

**3682053.....42-48**  
16 per car 8.309-0  
.....  
**CALL** ⚠

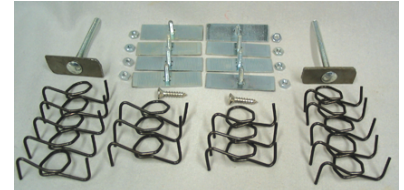

**3682053B.....42-48**  
Clips, bolts & screws for rocker moulding. Fastener set does both sides. 8.309-0  
.....  
**CALL** ⚠

**3688845.....42-48**  
Short bolt. 8 per car (8 pcs). 8.309-0.3  
.....  
**\$10.00 SET** ⚠



**442033A.....42-48**  
Stainless (2 per car) 8.309-0.4  
.....  
**\$3.50 SET** ⚠

## 1949-55 Rocker Moulding Clips And Bolts



**3688946.....49-52**  
4 per car 8.309-0.15  
.....  
**\$19.25 SET** ⚠



**3690097.....49-52**  
Clips & bolts. Fastener set does both sides. 8.309-0.15  
.....  
**\$45.00 SET** ⚠

Returns require a return authorization number—call first. • Product pricing & availability subject to change.

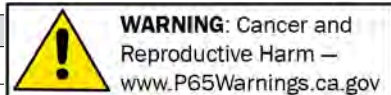

**1949-55 Rocker Moulding Clips And Bolts, cont.**

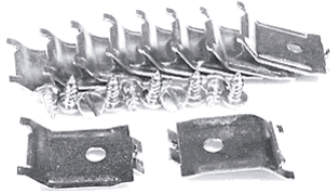

**3698436** .....**53-55**  
Clips & bolts. Fastener set does both sides. 8.309 -0.15 ..... **\$24.25 SET** ⚠

**Foot Scraper**



**6052512**..... **41**  
Rubber blocks on front of foot scraper  
8.892 -0.15 .....

**\$77.00 L&R** ⚠



**6052512A** ..... **41**  
Rubber pad for accessory foot scraper to rocker panel (12 ft)  
8.892 -0.15 .....

**\$50.75 SET** ⚠

**985713AL** ..... **41**  
Foot scrapers at rocker panel 8.892 -0.15  
..... **\$2,145.00 PR** ⚠



**3847443A** .....**42-48**  
Rubber pad with hollow bead foot scraper. Mounts to body under door fender extension. 1 foot length. 8.307 -0.2 .....  
**\$3.00 FT** ⚠

**Rubber Plug**



**4805844**..... **41**  
Bottom of rocker panels (4 pcs) 9.775 -0 .....  
**\$9.00 SET** ⚠



**4805845**.....**41-48**  
Floorboard, oval shaped  
9.775 -0.4 ..... **\$2.25 EA**  
⚠



**4034101A** .....**42-48**  
Rear of rocker in wheel well 9.775 -0.15 .....

**\$12.00 SET** ⚠



**4595715**.....**53-57**  
In rocker panel  
9.775 -0.15 .....

**\$4.25 PR** ⚠

**Odds And Ends**

Please call for availability on all Odds & Ends parts. Once part is sold, it may no longer be in stock.

**4567431U** .....**49-52**  
Rear fender extension on rocker panel, right side, fits wagon Used, needs to be rechromed 8.300 -0.4 ..... **\$30.00 EA** ⚠  
**4567432U** .....**49-52**  
Rear fender extension on rocker panel, left side, fits wagon Used, needs to be rechromed 8.300 -0.4 ..... **\$30.00 EA** ⚠  
**4594176U** ..... **51-52**  
Rear fender extension on rocker panel, right side, fits wagon, used 8.300 -0.4 .... **\$40.00 EA** ⚠  
**4594177U** ..... **51-52**  
Rear fender extension on rocker panel, left side, fits wagon, used 8.300 -0.4 ..... **\$40.00 EA** ⚠  
**986963**..... **53-54**  
Accy. Door Edge Guard- 4-door (NOS)  
10.352 -0.4 ..... **\$75.00 PR** ⚠



**WARNING:** Cancer and Reproductive Harm – [www.P65Warnings.ca.gov](http://www.P65Warnings.ca.gov)

Chemicals shipped domestic ground only (Lower 48 states only). No international shipping.

**Phone: (360) 816-0211 • (800) 999-CHEV (2438) • [www.chevsofthe40s.com](http://www.chevsofthe40s.com)**



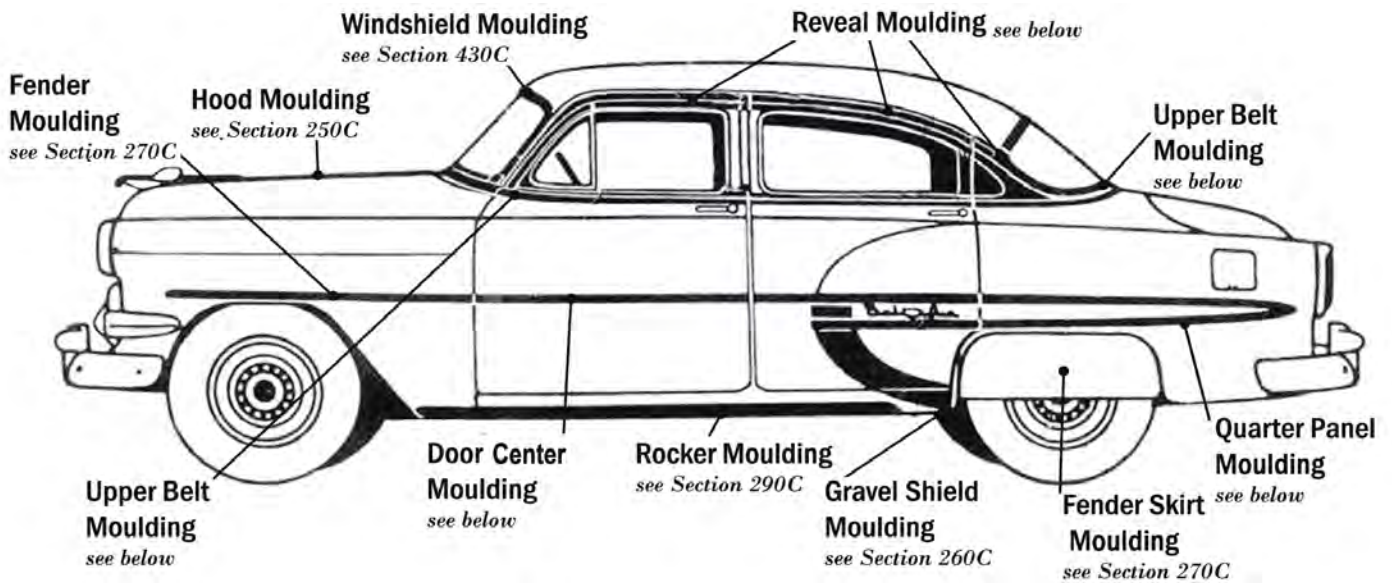

**SECTION 294C RESTORATION PARTS**

We are going to great lengths to find replacement nylon clips to replace the original metal clips. Unlike metal clips, installing these superior nylon clips keeps paint from chipping and creating a rust point.

**4603676** ..... **53-54**  
210 Quarter moulding Clips 6 pieces -0  
**\$50.00 SET** ⚠

**Hood Center Moulding Clips**



**59752338** ..... **38**  
Bolts & clips for one side center moulding.  
8.005 -0.4 **\$10.00 SET** ⚠



**3658783** ..... **41-48**  
Retains painted vertical nose moulding. 8.056 -0  
..... **CALL** ⚠



**3688261** ..... **49-52**  
Retains hood center moulding. 8.056 -0.3  
**\$5.00 EA** ⚠

**Hood Side Moulding**



**595209** ..... **37**  
Uses 2. 25" length. 8.005 -0.2  
**\$94.00 EA** ⚠

**Hood Side Moulding, cont.**



**597516** ..... **38**  
Upper & Lower (uses 4) 8.005 -0.15  
**\$56.50 EA** ⚠



**597557** ..... **38**  
Center (uses 2). 8.005 -0.15  
**\$49.00 EA** ⚠

**3653276** ..... **39**  
Stainless. Uses 8. 8.005 -0.15  
**\$37.50 EA** ⚠



**3653276S** ..... **39**  
Laser cut stainless. Gangster grille style.  
8.005 -0.15 **\$220.75 PR** ⚠

**Hood Side Moulding Clips**



**4082247A** ..... **37**  
Clips for one side moulding (6 pcs).  
10.695 -0.4  
**\$12.50 SET** ⚠

**Hood Side Moulding Clips, cont.**



**597522** ..... **38-39**  
Side moulding (exc 38 center). 1 side moulding (6 pcs). 8.005 -0.3  
**\$16.50 SET** ⚠

**Garnish Moulding Clips**



**4090876** ..... **39**  
This u-clip is for the garnish moulding bottom support for Deluxe Master Sedan and Deluxe Master Coupe. 11.133 -0.3  
**\$5.50 EA** ⚠



**4112927** ..... **40-48**  
Garnish moulding bottom support u-clips (exc Cabriolet, Fleetline 4-door & wagon)  
**CALL** ⚠

11.133 -0.3



**4563383** ..... **49-52**  
Garnish moulding bottom support u-clips door & quarter, Convertible & Hardtop  
**CALL** ⚠

11.133 -0.1



**4112927** ..... **49-57**  
Garnish moulding bottom support u-clips quarter on 2-door Sedan & 49-52 Coupe  
**CALL** ⚠

11.133 -0.3

**Reveal Moulding Clips**

- 4105730A** ..... **40**  
Around side windows (10 pcs). 10.708 -0.4  
..... **\$5.25 SET** ⚠
- 4114230** ..... **41-48**  
Around side windows (Coupe uses 90,  
4-door uses 120, 2-door uses 96) (10  
pcs). 10.708 -0.2 ..... **\$5.50 SET** ⚠
- 4561940** ..... **49-52**  
Around side windows. 10.708 -0.3 .....  
**\$3.25 EA** ⚠
- 4637242** ..... **49-52**  
Above quarter window (2-door and Coupe)  
10.708 -0.2 ..... **\$20.00 SET** ⚠



**4571696** ..... **50-52**  
Under back glass. Fits  
hardtop. (Uses 8).  
11.209 -0 ..... **CALL** ⚠

**4571696S** ..... **50-52**  
Under back glass. Fits hardtop. Stainless  
(Set of 8). 11.209 -0 ..... **\$74.75 SET** ⚠



**4571697** ..... **50-52**  
Above back glass. Fits  
hardtop. (12 pcs)  
11.209 -0 ..... **CALL** ⚠

**4571697S** ..... **50-52**  
Above back glass. Fits hardtop. Stainless  
(12 pcs) 11.209 -0 ..... **\$114.75 SET** ⚠

**Upper Belt On Door Clips**

- 4114230** ..... **41**  
(10 pcs) 10.708 -0.2 ..... **\$5.50 SET** ⚠
- 4585973** ..... **41-46**  
Fits 4-door, front doors. 12.116 -0.2 .....  
**\$15.00 SET** ⚠
- 4562113** ..... **49-52**  
All exc Wagon 12.118 -0.2 ..... **\$1.75 EA** ⚠
- 4562113BB** ..... **53-54**  
All exc Wagon 12.118 -0.15 ..... **\$3.25 EA** ⚠

**Clips And Bolts Upper Belt On Quarter**

- 4116288C** ..... **41**  
Coupe & Cabriolet. 12.116 -0.2 .....  
**\$12.00 SET** ⚠
- 4116288K** ..... **41**  
4-door 12.116 -0.3 ..... **\$10.00 SET** ⚠
- 4116288S** ..... **41**  
2-door Sedan 12.116 -0.3 ..... **\$15.00 SET**  
⚠
- 4125726** ..... **42-47**  
These are the clips / bolts for the upper  
belt moulding. Made of nylon that  
replaces the metal clips. The original  
metal clips can wear the paint at the  
moulding hole, these nylon replacements  
keep your paint good and prevent rust.  
12.116 -0.2 ..... **\$3.75 SET** ⚠
- 4125726B** ..... **42-47**  
For moulding on quarter belt, Fleetline  
2-door. 12.116 -0.2 ..... **\$18.50 SET** ⚠

**Clips And Bolts Upper Belt On Quarter, cont.**

- 4125726C** ..... **42-47**  
Coupe & Cabriolet 12.116 -0.2 .....  
**\$16.75 SET** ⚠
- 4125726K** ..... **42-47**  
4-door 12.116 -0.2 ..... **\$11.00 SET** ⚠
- 4125726S** ..... **42-47**  
2-door Sedan 12.116 -0.3 ..... **\$22.00 SET**  
⚠
- 4125726D** ..... **48**  
For Moulding On Quarter Belt-fleetline-2  
Door. 12.116 -0.2 ..... **\$41.75 SET** ⚠
- 4162573A** ..... **48**  
Cabriolet 12.116 -0.3 ..... **\$17.25 SET** ⚠
- 4162573B** ..... **48**  
2 Door 12.116 -0.2 ..... **\$27.00 SET** ⚠
- 4162573C** ..... **48**  
For Moulding On Quarter Belt-4 Door  
12.116 -0.2 ..... **\$31.25 SET** ⚠
- 4562320C** ..... **49-54**  
For Moulding On Quarter Belt-coupe  
12.116 -0.3 ..... **\$24.00 SET** ⚠
- 4562320D** ..... **49-54**  
2 Door 12.116 -0.4 ..... **\$30.00 SET** ⚠
- 4562320S** ..... **49-54**  
4-door 12.116 -0.2 ..... **\$18.00 SET** ⚠
- 4562321E** ..... **49-54**  
Convertible 12.116 -0.15 ..... **\$27.00 SET** ⚠
- 4562321H** ..... **49-54**  
Fits hardtop 12.116 -0.3 ..... **\$24.00 SET** ⚠
- 4580629S** ..... **50-52**  
Stainless Upper Belt Moulding Clips From  
B Pillar To Rear Window. set of 10  
11.209 -0 ..... **\$165.25 SET** ⚠

**Front Fender Moulding**



- 3693873R** ..... **49-50**  
Front fender reproduction 8.132 -0.15  
**\$55.25 EA** ⚠
- 4561289U** ..... **49-52**  
Upper belt moulding. Right side. Fits  
4-door. Used in good condition 12.112 -0.15  
..... **\$60.00 EA** ⚠
- 4561290U** ..... **49-52**  
Upper belt moulding. Left side. Fits 4-door  
used in good condition -0.15 .....  
**\$60.00 EA** ⚠
- 3700036** ..... **52**  
Moulding, Nos Front Fender -0 ..... **CALL**  
⚠
- 3698359** ..... **53-54**  
Left 8.132 -0.15 ..... **\$54.00 EA** ⚠



**Front Fender Moulding, cont.**



**3698360** ..... **53-54**  
Right 8.132 -0.15 ..... **\$54.00 EA** ⚠

**Front Fender Moulding Clips**

- 3667254** ..... **42-48**  
Bolt for front fender extension moulding  
(cap on door). Fits Fleetline (uses 6 per  
side). 6 Piece Set. 8.133 -0.15 ..... **\$4.50 SET**  
⚠
- 4114412** ..... **42-48**  
Clip-set for front fender extension  
moulding (cap on door). Fits Fleetline (9  
per side) (9 pcs) 8.133 -0 ..... **CALL** ⚠
- 3700044** ..... **49-50**  
Clip-bolt set does one front fender  
moulding (6 pcs) 8.309 -0.2 ..... **\$7.50 SET** ⚠
- 3700044** ..... **52-54**  
Clip-bolt set does one front fender  
moulding (6 pcs) 8.133 -0.15 ..... **\$4.50 SET**  
⚠

**Door Center Moulding**

- 4560098** ..... **49-50**  
(Spear) fits 2 or 4 door front door, 38-1/2"  
long, 7/8" wide. 12.112 -0.15 ..... **\$46.00 EA**  
⚠
- 4587007** ..... **51-52**  
(Spear) door center, 2-door, 45in. long  
12.112 -0.15 ..... **\$31.25 EA** ⚠
- 4587007N** ..... **51-52**  
(Spear) door center, 2-door, 45in. long  
12.112 -0 ..... **CALL** ⚠



**4613753** ..... **53-54**  
2-door 12.112 -0.15 ..... **\$60.75 EA** ⚠

**Door Center Moulding Clips Does One Door**

- 456222750** ..... **49-50**  
(6 pcs) 12.117 -0.2 ..... **\$7.50 SET** ⚠
- 456222752** ..... **51-52**  
(9 pcs) 12.117 -0.15 ..... **\$6.75 SET** ⚠
- 4574742** ..... **53-54**  
4-door models 12.117 -0.3 ..... **\$8.50 SET**  
⚠
- 4574742A** ..... **53-54**  
2-door models 12.117 -0.3 ..... **\$8.50 SET**  
⚠

**WARNING: Cancer and Reproductive Harm** —  
www.P65Warnings.ca.gov

Chemicals shipped domestic ground only (Lower 48 states only). No international shipping.

Phone: (360) 816-0211 • (800) 999-CHEV (2438) • www.chevsofthe40s.com



**Lower Belt Clips Door And Cowl**

- 4562321** ..... **41**  
(Does 2) cowl mouldings between door & hood (4 pcs) 12.116-0.3 .. **\$2.00 SET** ⚠
- 409925** ..... **41-46**  
Thru handle (12 pcs). 12.117-0.3 .....  
**\$6.00 SET** ⚠

**Quarter Lower Belt Clips At Door Handle Level**

- 4089649A** ..... **40**  
(10 pcs) 12.118-0.3 ..... **\$5.25 SET** ⚠
- 4562321B** ..... **41-46**  
Coupe, Cabriolet 12.116-0.2 .....  
**\$15.00 SET** ⚠
- 4562321C** ..... **41-46**  
2 Door Sedan 12.116-0.2 .. **\$17.25 SET**  
⚠
- 4562321D** ..... **41-46**  
At Door Handle Level-4 Door 12.116-0.2  
..... **\$10.25 SET** ⚠

**Rear Fender And Quarter Panel Clips**

- 3667524** ..... **42-48**  
Bolts for rear fender moulding. Fleetline  
(uses 6 per fender) (6 piece set)  
8.133-0.15 ..... **\$4.50 SET** ⚠
- 4114412A** ..... **42-48**  
Clip-bolt set for rear fender moulding. Fits  
Fleetline (15 per fender) (15 piece set)  
8.133-0.15 ..... **\$9.75 SET** ⚠
- 4614937** ..... **52**  
For 2 quarter panels. 12.116-0.15 .....  
**\$9.00 SET** ⚠
- 4603301B** ..... **53-54**  
For two quarter panels, Bel Air 2-door  
Sedan, Hardtop, Convertible 12.116-0.15  
**\$15.00 SET** ⚠
- 4603305B** ..... **53-54**  
For two quarter panels, Bel Air 4-door,  
4-door Wagon 12.116-0.3 **\$22.00 SET** ⚠
- 4603307B** ..... **53-54**  
For 2 quarter panels. Fits 210 4-door  
Sedan, 4-door Wagon 12.116-0.3 .....  
**\$22.00 SET** ⚠
- 4603309B** ..... **53-54**  
For two quarter panels, 210 2-door  
Sedan, Hardtop, Convertible 12.116-0.15  
**\$12.00 SET** ⚠

**Front And Rear Fender Moulding Clips Fleetline**

- 4114412B** ..... **42-48**  
Clip-bolt set for Fleetline fender  
mouldings excluding the fender skirts (set  
for 1 car) 8.133-0.15 ..... **\$50.00 SET** ⚠
- 4114412C** ..... **42-48**  
Clip-bolt set for Fleetline fender skirt  
mouldings (set for 1 car) 8.133-0 .....  
**\$15.75 SET** ⚠

**Running Board Mouldings**



- 593614C** ..... **34-38**  
77-3/4" X 3/4" replacement style w/ clips.  
Stainless. 8.309-0.1 ..... **\$425.00 PR** ⚠



- 593392** ..... **39**  
Replacement style stainless (includes  
clips).  
75-3/8" X 1/2". 8.304-0.15 .....  
**\$425.00 PR** ⚠



- 3653729B** ..... **40**  
68-3/8" x 1" w/ clips 8.309-0.3 .....  
**\$425.00 PR** ⚠

**Running Board Moulding Clips**

Note: Running board mouldings have been reproduced in different widths. Choose clips based on the size of your mouldings.

- 370044** ..... **34-38**  
Running Board Moulding Bolts (4 pieces).  
8.309-0.2 ..... **\$4.00 SET** ⚠

- 593617B** ..... **34-38**  
Original running board  
moulding. Fastener set  
does both sides. 8.309-0  
..... **CALL** ⚠

- 350613** ..... **39**  
20 pcs. Does both  
sides. 8.304-0.15 .....  
**\$6.00 SET** ⚠



- 350613B** ..... **39**  
Running board mouldings. Fastener set  
does both sides. 8.304-0.3 .. **\$20.00 SET**  
⚠

- 3664679** ..... **39**  
4 per car (4 pcs). (Use  
with 350613) 8.309-0.15  
..... **\$2.00 SET** ⚠



**Running Board Moulding Clips, cont.**



- 3653730** ..... **40**  
Running clips - for use  
with 1-1/4" running  
board mouldings.  
Deluxe. (Use with  
3664679) 8.309-0.15 ..... **\$2.25 EA** ⚠

- 3653730B** ..... **40**  
For moulding 1-1/4in.  
wide. Fastener set of  
clips & bolts, does both sides. 8.309-0.15  
..... **\$48.00 SET** ⚠

- 3653730C** ..... **40**  
For mouldings 1in. wide. Fastener set  
does both sides. 8.309-0.15 ..... **\$18.00 SET**  
⚠

- 370044** ..... **40**  
Running Board Moulding Bolts (4 Per Car)  
4pcs. 8.309-0.2 ..... **\$4.00 SET** ⚠

- 593617C** ..... **40**  
Running Board  
Moulding Clips & Bolts.  
For moulding 7/8in.  
wide. Fastener set does both sides.  
8.309-0 ..... **CALL** ⚠

**Rocker Mouldings**



- 3658690N** ..... **41**  
Shelf worn (NOS). 8.304-0.4 ..... **CALL**  
⚠



- 3681636** ..... **42-48**  
Rocker Mouldings - Stainless 8.304-0  
**CALL** ⚠



- 3688947** ..... **49-52**  
Rocker mouldings 8.304-0.15 .....  
**\$199.00 PR** ⚠



- 3698437** ..... **53-54**  
Rocker mouldings 8.304-0.15 .....  
**\$157.50 PR** ⚠

**Rocker Moulding Clips And Bolts**



**3658565B** ..... **41**  
Clips & Bolts (does 2) 8.309 -0 .....  
**\$74.00 SET** ⚠

**3688845** ..... **41**  
6 per car 8.309 -0.3 ..... **\$7.50 SET** ⚠



**3682035** ..... **42-48**  
Long bolt. 2 per car (2  
pcs) 8.309 -0.15 .....  
**\$3.00 SET** ⚠

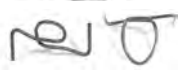

**3682053** ..... **42-48**  
16 per car 8.309 -0  
**CALL** ⚠

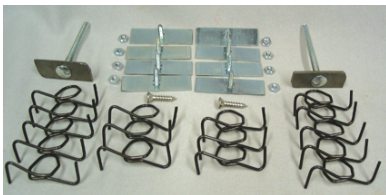

**3682053B** ..... **42-48**  
Clips, bolts & screws for rocker moulding.  
Fastener set does both sides. 8.309 -0  
..... **CALL** ⚠

**3688845** ..... **42-48**  
Short bolt. 8 per car (8 pcs). 8.309 -0.3  
..... **\$10.00 SET** ⚠



**442033A** ..... **42-48**  
Stainless (2 per car)  
8.309 -0.4 .....  
**\$3.50 SET** ⚠



**3688946** ..... **49-52**  
4 per car 8.309 -0.15  
..... **\$19.25 SET** ⚠



**3690097** ..... **49-52**  
Clips & bolts. Fastener set does both  
sides. 8.309 -0.15 ..... **\$45.00 SET** ⚠

**Rocker Moulding Clips And Bolts, cont.**

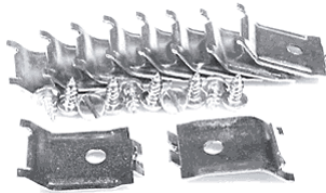

**3698436** ..... **53-55**  
Clips & bolts. Fastener set does both  
sides. 8.309 -0.15 ..... **\$24.25 SET** ⚠

**Foot Scraper**

**985713AL** ..... **41**  
Foot scrapers at rocker panel 8.892 -0.15  
..... **\$2,145.00 PR** ⚠

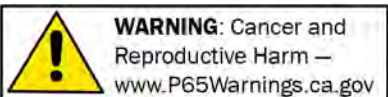

Chemicals shipped domestic ground only (Lower 48 states only). No international shipping.

**Phone: (360) 816-0211 • (800) 999-CHEV (2438) • www.chevsofthe40s.com**



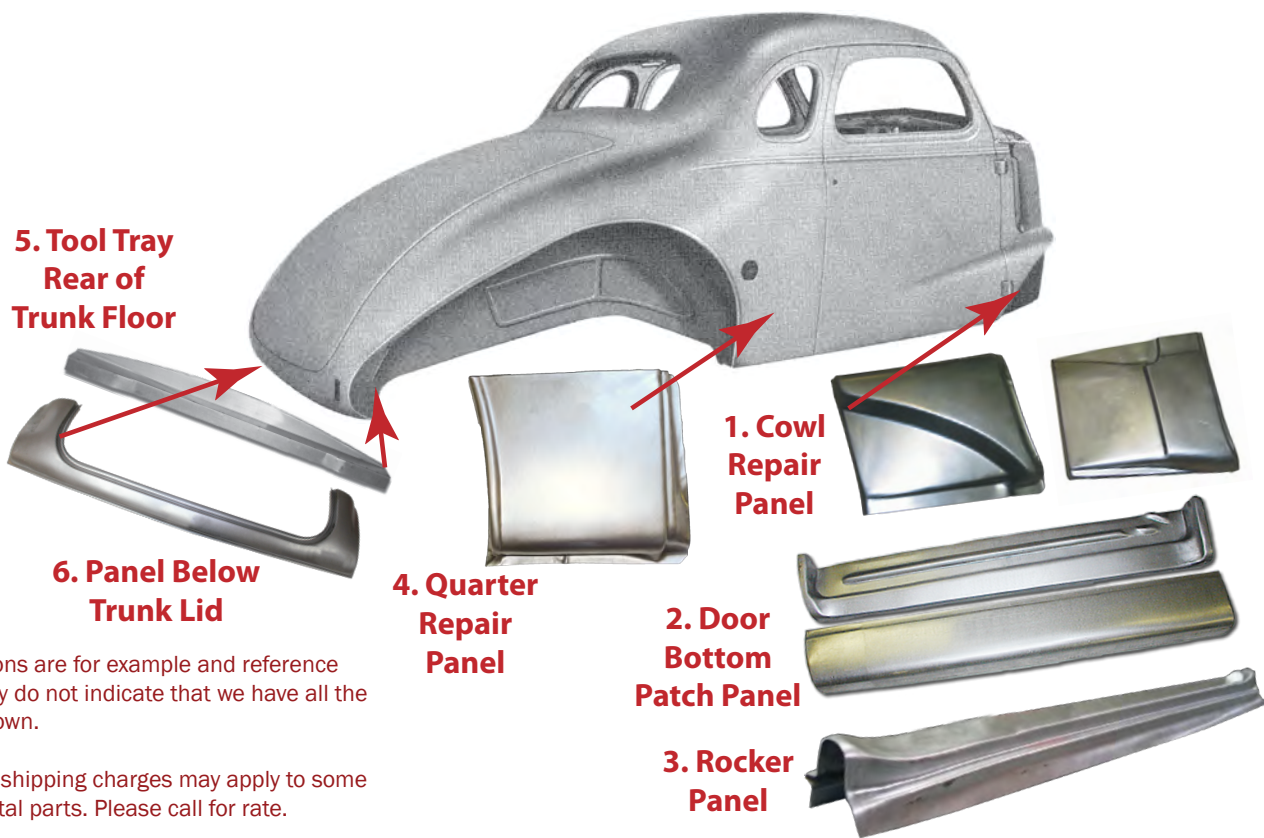

Illustrations are for example and reference only. They do not indicate that we have all the parts shown.

Oversize shipping charges may apply to some sheetmetal parts. Please call for rate.

|   |                       |
|---|-----------------------|
| <b>1. Cowl Repair Panel</b>   |                       |
| <b>4076790A</b> .....   | <b>37-38</b>          |
| Die-stamped. Left 12.803 -0.15 .....  |                       |
| <b>\$183.25 EA</b> ⚠  |                       |
| <b>4076791A</b> .....   | <b>37-38</b>          |
| Die-stamped. Right 12.803 -0.15 .....                                       |                       |
| <b>\$183.25 EA</b> ⚠  |                       |
| <b>4083265EL</b> .....  | <b>39</b>             |
| Die-stamped. Left 12.803 -0.15 .....  |                       |
| <b>\$145.00 EA</b> ⚠  |                       |
| <b>4083265ER</b> .....  | <b>39</b>             |
| Die-stamped. Right 12.803 -0.15 .....                                       |                       |
| <b>\$145.00 EA</b> ⚠  |                       |
| <b>2. Door Bottom Patch Panel</b>   |                       |
| <b>4091056CL</b> .....  | <b>37-39</b>          |
| Die-stamped. Inner & outer, Coupe, left (2 pcs). 10.531 -0.15 .....         | <b>\$225.00 SET</b> ⚠ |
| <b>4091056CR</b> .....  | <b>37-39</b>          |
| Die-stamped. Inner & outer, Coupe, right (2 pcs). 10.531 -0.15 .....        | <b>\$225.00 SET</b> ⚠ |
| <b>4091056L</b> .....   | <b>37-39</b>          |
| Die-stamped. Inner & outer, 2-door sedan, left (2 pcs). 10.531 -0.15 .....  | <b>\$225.00 SET</b> ⚠ |
| <b>4091056R</b> .....   | <b>37-39</b>          |
| Die-stamped. Inner & outer, 2-door sedan, right (2 pcs). 10.531 -0.15 ..... | <b>\$225.00 SET</b> ⚠ |

|  |                      |
|--|----------------------|
| <b>3. Rocker Panel</b>                                       |                      |
| <b>4091780</b> .....   | <b>37-39</b>         |
| Die-stamped 2-door sedan, left. Curved 12.934 -0.15 .....    | <b>\$145.00 EA</b> ⚠ |
| <b>4091781</b> .....   | <b>37-39</b>         |
| Die-stamped. Coupe, right. Curved 12.934 -0.15 .....         | <b>\$156.25 EA</b> ⚠ |
| <b>4091782</b> .....   | <b>37-39</b>         |
| Die-stamped. 2-door sedan , right. Curved 12.934 -0.15 ..... | <b>\$182.25 EA</b> ⚠ |
| <b>4091782B</b> .....  | <b>37-39</b>         |
| Die-stamped. Coupe, left. Curved 12.934 -0.15 .....          | <b>\$183.25 EA</b> ⚠ |
| <b>4. Quarter Repair Panel</b>                               |                      |
| <b>391027A</b> .....   | <b>37-39</b>         |
| Die-stamped. 2-door sedan, left. 12.944 -0.15 .....          | <b>\$144.75 EA</b> ⚠ |
| <b>391028A</b> .....   | <b>37-39</b>         |
| Die-stamped. 2-door sedan, right. 12.944 -0.15 .....         | <b>\$144.75 EA</b> ⚠ |
| <b>391029</b> .....  | <b>37-39</b>         |
| Die-stamped. Coupe, left. 12.944 -0.15 .....                 | <b>\$183.25 EA</b> ⚠ |
| <b>391030</b> .....  | <b>37-39</b>         |
| Die-stamped. Coupe, right. 12.944 -0.15 .....                | <b>\$182.25 EA</b> ⚠ |

|   |                      |
|---|----------------------|
| <b>5. Tool Tray Rear Of Trunk Floor</b>                                     |                      |
| <b>379957A</b> .....  | <b>37-38</b>         |
| Die-stamped. Coupe and sedan (exc Sedan Delivery). 12.966 -0.15 .....       | <b>\$159.25 EA</b> ⚠ |
| <b>4091817</b> .....  | <b>39</b>            |
| Die-stamped. Fits Coupe & Sedan (exc Sedan Delivery). 12.986 -0.15 .....    | <b>\$322.50 EA</b> ⚠ |
| <b>6. Panel Below Trunk Lid</b>   |                      |
| <b>4083291A</b> .....   | <b>37-38</b>         |
| Die-stamped. Coupe exc w/ rumble seat. 12.996 -0.15 .....                   | <b>\$356.75 EA</b> ⚠ |
| <b>4083291B</b> .....   | <b>37-38</b>         |
| Die-stamped. Sedan, Sedan Delivery requires modification 12.966 -0.15 ..... | <b>\$356.75 EA</b> ⚠ |
| <b>4091827A</b> .....   | <b>39</b>            |
| Die-stamped. Coupe 12.966 -0.15 .....                                       | <b>\$357.00 EA</b> ⚠ |
| <b>4091827B</b> .....   | <b>39</b>            |
| Die-stamped. Sedan 12.966 -0.15 .....                                       | <b>\$357.75 EA</b> ⚠ |

Returns require a return authorization number—call first. • Product pricing & availability subject to change.

**WARNING:** Cancer and Reproductive Harm — www.P65Warnings.ca.gov



Illustrations are for example and reference only. They do not indicate that we have all the parts shown. Oversize shipping charges may apply to some sheetmetal parts. Please call for rate.

**1. Firewalls for Chevy V8**



- 4091695X39 ... 37-39**  
Small block. 12.803 -0.15  
... **\$380.50 EA** ⚠
- 4091695Y39 ... 37-39**  
Big block. 12.803 -0.15  
..... **\$386.25 EA** ⚠

**10. Running Board Brackets**

- 593692..... 37-39**  
Fabricated. Front (17in.) 7.016 -0.15  
..... **\$31.00 EA** ⚠
- 593693..... 37-39**  
Fabricated. Rear (14-1/2in.) 7.016 -0.15  
..... **\$29.75 EA** ⚠

**2. Cowl Vent Filler Panel**

- 4093394T39 ..... 37-39**  
Fabricated. Eliminate cowl vent. 10.307 -0.4  
..... **\$40.00 EA** ⚠

**3. Inner Cowl Support**

- 4083265AL ..... 37-39**  
Fabricated. Inner left 12.804 -0.15  
..... **\$93.00 EA** ⚠
- 4083265AR ..... 37-39**  
Fabricated. Inner right 12.803 -0.15  
..... **\$92.75 EA** ⚠

**4. Transmission Cover**

- 36503870S ..... 37-39**  
Trans Cover, Automatic Oversized 12.565 -0  
..... **\$212.50 EA** ⚠
- 3650387T39 ..... 37-39**  
Fabricated. For auto transmission.  
12.565 -0.15 ..... **\$176.50 EA** ⚠

**5. Floorboard Repair Panels Front**

- 4132412L39 ..... 37-39**  
Fabricated. Front, left 12.980 -0.15  
..... **\$233.00 EA** ⚠
- 4132412R39..... 37-39**  
Fabricated. Front, right 12.980 -0.15  
..... **\$223.00 EA** ⚠

**6. Door Bottom Patch Panel**

- 4091056A ..... 37-39**  
Fabricated repair panel, outer. Trim for 4  
door. 10.531 -0.2 ..... **\$42.00 EA** ⚠

**7. Rocker Panel Straight**

- 4091777A ..... 37-39**  
Fabricated. 2-door sedan, left. Straight  
45" long 12.934 -0.2 ..... **\$52.50 EA** ⚠
- 4091779A ..... 37-39**  
Fabricated. Fits Coupe. Right side.  
12.934 -0.3 ..... **\$52.50 EA** ⚠
- 4091780A ..... 37-39**  
Fabricated. Fits coupe. Left side.  
12.934 -0.3 ..... **\$52.50 EA** ⚠
- 4091782A ..... 37-39**  
Fabricated. 2-door, right. 12.934 -0.2  
..... **\$52.50 EA** ⚠

**8. Rocker Panel Inner**

- 4091777I ..... 37-39**  
Fabricated. Right side, inner panel. Fits  
37-39 Sedans & Coupes (need to cut  
length for Coupe). 18 Gauge 12.934 -0.15  
..... **\$59.00 EA** ⚠
- 4091778I ..... 37-39**  
Fabricated. Left side, inner panel. Fits  
37-39 Sedans & Coupes (need to cut  
length for Coupe). 18 Gauge 12.934 -0.15  
..... **\$59.00 EA** ⚠

**9. Running Boards Smooth Steel**

- 602913S ..... 37-38**  
Fabricated. Smooth 16ga.cold rolled  
steel. 8.299 -0 ..... **CALL** ⚠
- 603957S ..... 39**  
Smooth 16ga.cold rolled steel. 8.299 -0  
..... **CALL** ⚠

**Floorboard Center Streetrod**

- 4132413V39 ..... 37-39**  
Fabricated. 2-door & 4-door sedans.  
12.980 -0.15 ..... **\$335.75 EA** ⚠

**Floorboard Front Streetrod**

- 4132412X39 ..... 37-39**  
Fabricated. Small block 12.980 -0.15  
..... **\$311.00 SET** ⚠
- 4132412Y39 ..... 37-39**  
Fabricated. Big block 12.980 -0.15  
..... **\$312.00 SET** ⚠

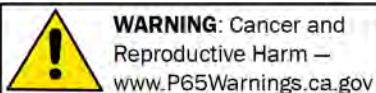

Chemicals shipped domestic ground only (Lower 48 states only). No international shipping.

**Phone: (360) 816-0211 • (800) 999-CHEV (2438) • www.chevsofthe40s.com**



**Floorboard Front Streetrod, cont.**

**4132412Z39** .....**37-39**  
 Fabricated. Stock firewall 12.980 -0.15 ..  
**\$312.00 SET** ⚠

**Floorboard Rear Streetrod**

**4132414V39** .....**37-39**  
 Fabricated. 2/4 door sedans. Includes rear sear riser, the rise over the axle.  
 12.980 -0.15 ..... **\$265.50 EA** ⚠

**4132414W39** .....**37-39**  
 Fabricated. Coupe 12.980 -0.15 .....  
**\$329.00 SET** ⚠

**Rocker Panel 4 Door**

**4091779EF** .....**37-39**  
 Fabricated. Right, front of 4 door Complete including inner rocker (43-1/2" length) From door post to center door post. 12.934 -0.15 ..... **\$104.50 EA** ⚠

**4091779ER** .....**37-39**  
 Fabricated. Right, rear. Complete w/ inner rocker panel (18" length) 12.934 -0.15 .  
**\$83.25 EA** ⚠

**4091780EF** .....**37-39**  
 Fabricated. Left, front of 4 door Complete including inner rocker (43-1/2" length) From door post to center door post. 12.934 -0.15 ..... **\$104.50 EA** ⚠

**4091780ER** .....**37-39**  
 Fabricated. Left, rear. Complete w/ inner rocker panel (18" length) 12.934 -0.15 .  
**\$69.00 EA** ⚠

**Running Boards Fiberglass**

**602913A** .....**37-38**  
 Stock fiberglass. 8.299 -0.15 .....  
**\$686.50 L&R** ⚠

**602913C** .....**37-38**  
 Smooth fiberglass. 8.299 -0.15 .....  
**\$624.75 L&R** ⚠

**603957A** ..... **39**  
 Stock fiberglass. 8.299 -0.15 .....  
**\$629.25 L&R** ⚠

**603957C** ..... **39**  
 Smooth fiberglass. 8.299 -0.15 .....  
**\$624.75 L&R** ⚠

**Running Boards Fiberglass for 2 inch Wider Rear Fenders**

**602913CW** .....**37-38**  
 Smooth fiberglass. 8.299 -0.15 .....  
**\$586.25 L&R** ⚠

**603957CW** ..... **39**  
 Smooth fiberglass. 8.299 -0.15 .....  
**\$624.75 L&R** ⚠

**Running Boards Smooth Steel for 2 inch Wider Rear Fenders**

**602913SW** .....**37-38**  
 Fabricated. Smooth 16ga.cold rolled steel. 8.299 -0 ..... **CALL** ⚠

**603957SW** ..... **39**  
 Fabricated. Smooth 16ga.cold rolled steel. 8.299 -0 ..... **CALL** ⚠

**Trunk Floorboards**

**4117482W38** .....**37-38**  
 Fabricated. Coupe. 16 Gauge. 12.980 -0  
 ..... **\$412.00 SET** ⚠



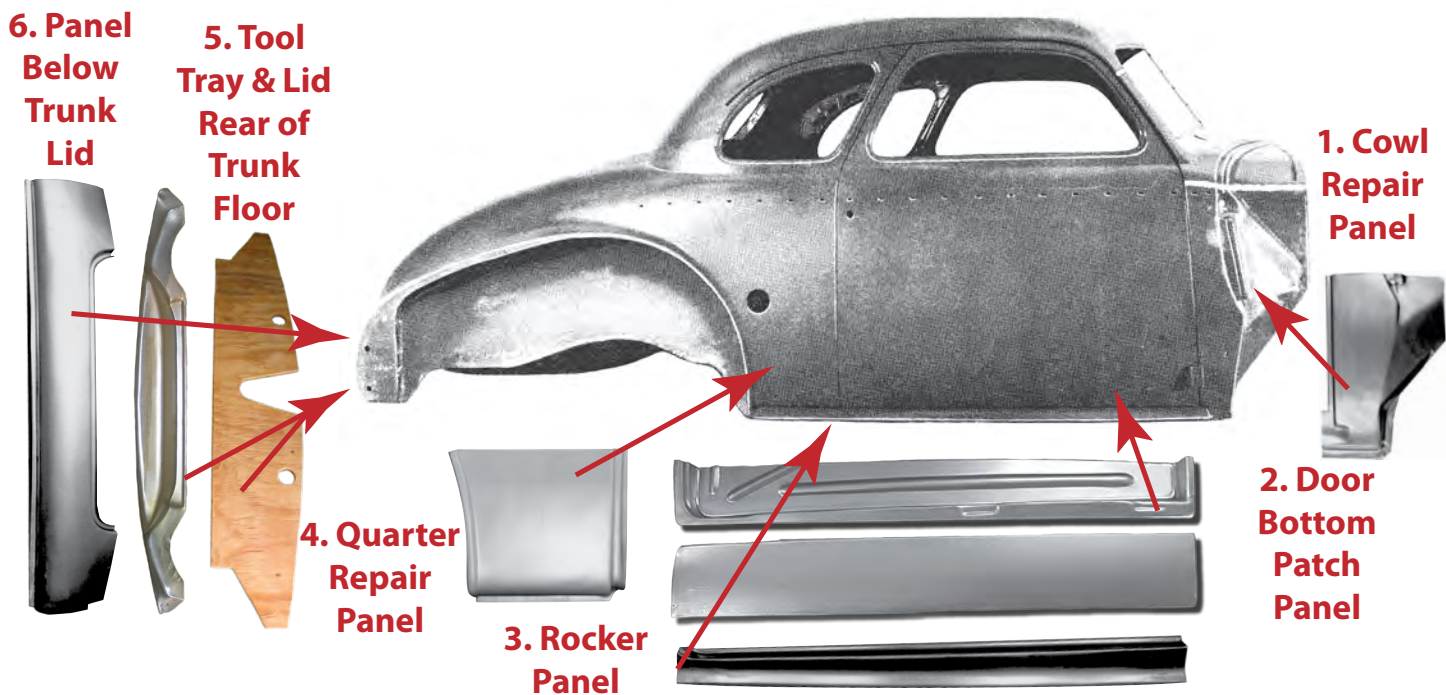

**1. Cowl Repair Panel**

- 4103067EL** ..... 40  
Die-stamped. Lower front, left. 12.803 -0.15  
..... **\$156.25 EA** ⚠
- 4103067ER** ..... 40  
Die-stamped. Lower front, right.  
12.803 -0.15 ..... **\$144.75 EA** ⚠

**2. Door Bottom Patch Panel**

- 4103264CL** ..... 40  
Die-stamped. Inner & outer. Fits 2-door & coupe, left (2 pcs). 10.531 -0.15  
..... **\$222.75 SET** ⚠
- 4103264CR** ..... 40  
Die-stamped. Inner & outer. Fits 2-door & coupe, right (2 pcs). 10.531 -0.15  
..... **\$222.75 SET** ⚠

**3. Outer Rocker Panel**

- 4103091EL** ..... 40  
Die-stamped. Left 12.934 -0.15  
..... **\$156.25 EA** ⚠
- 4103092ER** ..... 40  
Die-stamped. Right 12.934 -0.15  
..... **\$156.25 EA** ⚠

**4. Quarter Repair Panel**

- 4103126** ..... 40  
Die-stamped. Front of rear, right.  
12.944 -0.15 ..... **\$145.00 EA** ⚠
- 4103127** ..... 40  
Die-stamped. Front of rear, left.  
12.944 -0.15 ..... **\$145.00 EA** ⚠

**5. Tool Tray Rear of Trunk Floor**

- 4103106** ..... 40  
Die-stamped. Sedan (will fit Coupe w/  
minor adjustments). 12.966 -0.15 .....  
**\$325.00 EA** ⚠
- 4111690** ..... 40  
Lid (wood) for tool tray. Fits Sedan.  
12.540 -0.15 ..... **\$46.75 EA** ⚠

**6. Panel Below Trunk Lid**

- 4103105A** ..... 40  
Die-stamped. Coupe & Cabriolet.  
12.966 -0.15 ..... **\$356.75 EA** ⚠
- 4103105B** ..... 40  
Die-stamped. Sedan & Sedan Delivery  
12.966 -0.15 ..... **\$357.00 EA** ⚠

Illustrations are for example and reference only. They do not indicate that we have all the parts shown.

Oversize shipping charges may apply to some sheetmetal parts. Please call for rate.

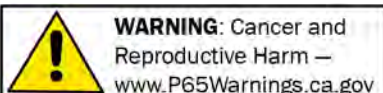



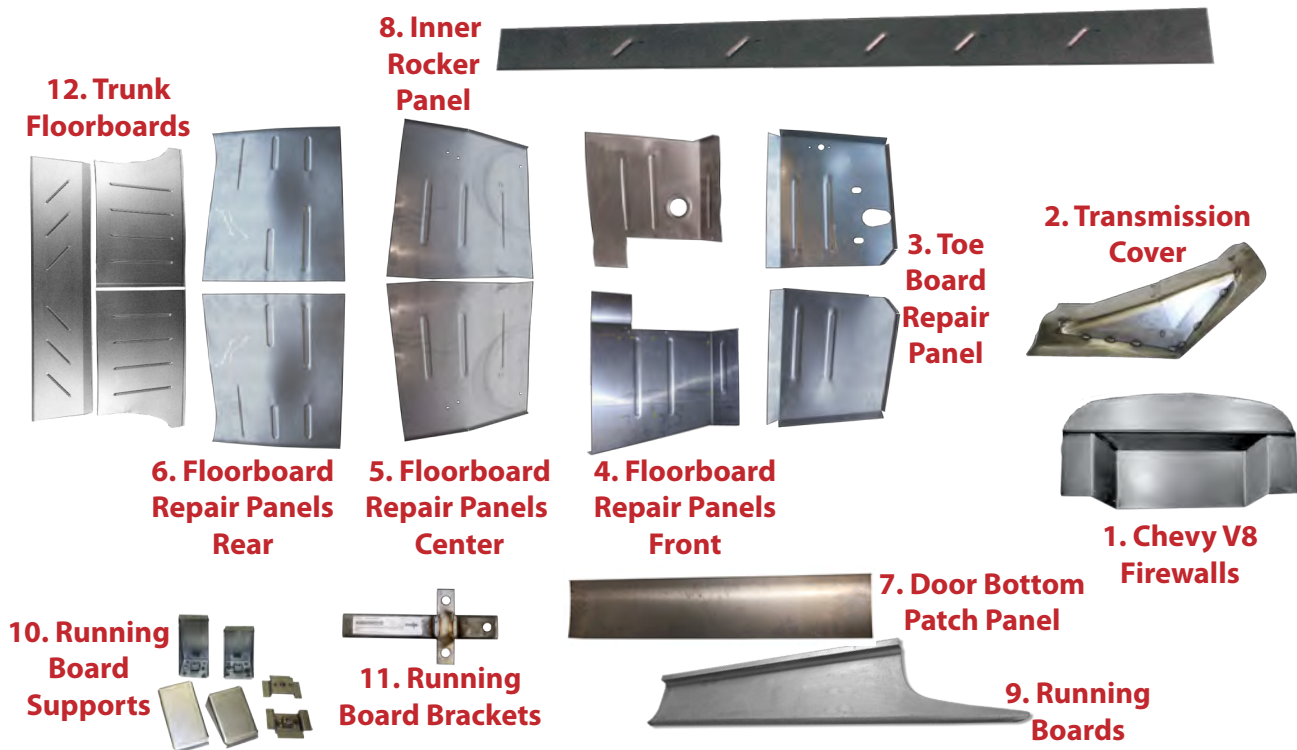

**1. Firewalls for Chevy V8**

**4103067X40** ..... 40  
Small block. 12.803 -0.15 .. **\$382.00 EA**

**4103067Y40** ..... 40  
Big block. 12.803 -0.15 **\$386.25 EA** ⚠

**2. Transmission Cover**

**3650387U40** ..... 40  
Fabricated. For auto transmission.

12.565 -0.15 ..... **\$176.50 EA** ⚠

**36528810S** ..... 40  
Trans cover, Automatic Oversized 12.565 -0

..... **\$212.50 EA** ⚠

**3. Toe Board Repair Panel**

**4132412TL40** ..... 40  
Fabricated. Left side. -0.15 . **\$99.00 EA**

**4132412TR40** ..... 40  
Fabricated. Right side. -0.15 **\$99.00 EA**

**4. Floorboard Repair Panels Front**

**4132412L40** ..... 40  
Fabricated. Front, left 12.980 -0.2

..... **\$321.25 EA** ⚠

**4132412R40** ..... 40  
Fabricated. Front, right 12.980 -0.2

..... **\$298.50 EA** ⚠

**Floorboards Front Streetrod**

**4132412X40** ..... 40  
Fabricated. Small block 12.980 -0.15 ...

**\$301.75 EA** ⚠

**4132412Y40** ..... 40  
Fabricated. Big block 12.980 -0.15

..... **\$301.75 EA** ⚠

**4132412Z40** ..... 40  
Fabricated. Stock firewall 12.980 -0.15

..... **\$301.75 EA** ⚠

**5. Floorboard Repair Panels Center**

**4132412CL40** ..... 40  
Fabricated. Center, left (under seat). -0.15

..... **\$202.50 EA** ⚠

**4132412CR40** ..... 40  
Fabricated. Center, right (under

seat). -0.15 ..... **\$185.00 EA** ⚠

**6. Floorboard Repair Panels Rear**

**4132414L40** ..... 40  
Fabricated. Rear, left. -0.15 . **\$82.75 EA**

**4132414R40** ..... 40  
Fabricated. Rear, right. -0.15 **\$74.00 EA**

**Floorboards Rear Streetrod**

**4132414C** ..... 40  
2-door & 4-door. Coupe & Sedan. Back of

front floor to front of trunk (over rear axle).

Superior. 12.980 -0.15 .. **\$319.00 SET** ⚠

**7. Door Bottom Patch Panel**

**4103264A** ..... 40  
Fabricated repair panel. Fits L or R.

10.351 -0.15 ..... **\$30.00 EA** ⚠

**8. Inner Rocker Panel**

**4103091I** ..... 40  
Fabricated. Left, 62" long. 12.934 -0.2

..... **\$42.50 EA** ⚠

**4103092I** ..... 40  
Fabricated. Right, 62" long. 12.934 -0.2

..... **\$82.75 EA** ⚠

**4103097** ..... 40  
Fabricated. Right side, inner panel

43-3/4" long. Fits Sedans & Coupes. 18

Gauge 12.934 -0.15 ..... **\$58.00 EA** ⚠

**4103098** ..... 40  
Fabricated. Left side, inner panel. 43 3/4

long. Fits Sedans & Coupes. 18 Gauge

12.934 -0.15 ..... **\$58.00 EA** ⚠

**9. Running Boards Smooth Steel**

**3653587S** ..... 40  
Fabricated. Smooth 16ga. cold rolled

steel. 8.299 -0 ..... **CALL** ⚠

**Running Boards Smooth Steel for 2inch Wider Rear Fenders**

**3653587SW** ..... 40  
Fabricated. Smooth 16ga.cold rolled

steel. 7.016 -0 ..... **CALL** ⚠

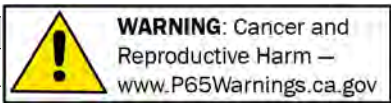

**Running Boards Fiberglass**

- 3653587A** ..... **40**  
Stock fiberglass. 8.299 -0.15 .....  
**\$629.25 L&R** ⚠
- 3653587C** ..... **40**  
Smooth fiberglass. 8.299 -0.15 .....  
**\$624.75 L&R** ⚠

**Running Boards Fiberglass for 2 inch Wider Rear Fenders**

- 3653587CW** ..... **40**  
Smooth fiberglass. 8.299 -0.15 .....  
**\$624.75 PR** ⚠

**10. Running Board Supports**

- 4103093B** ..... **40**  
Fabricated. Welds to inner rocker panel.  
Set of six. 12.934 -0.15 ..... **\$127.50 SET** ⚠

**11. Running Board Brackets**

- 3653582** ..... **40**  
Fabricated. Center or rear (left or right)  
(9in.). 7.016 -0.2 ..... **\$76.00 EA** ⚠
- 3653582CL** ..... **40**  
Fabricated. Front left (10-3/4in.).  
7.016 -0.15 ..... **\$42.50 EA** ⚠
- 3653582CR** ..... **40**  
Fabricated. Front right (10-3/4in. ).  
7.016 -0.2 ..... **\$42.50 EA** ⚠

**Trunk Floorboards Streetrod**

- 4117486** ..... **40**  
2 pcs street rod style. Sedan or Coupe.  
12.981 -0.15 ..... **\$267.00 SET** ⚠
- 4117486S** ..... **40**  
Fabricated. 3 pcs street rod style. Sedan  
or Coupe. 12.981 -0.15 ..... **\$348.25 SET** ⚠

Illustrations are for example and reference only. They do not indicate that we have all the parts shown.

Oversize shipping charges may apply to some sheetmetal parts. Please call for rate.

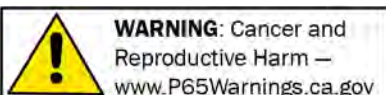

Chemicals shipped domestic ground only (Lower 48 states only). No international shipping.

**Phone: (360) 816-0211 • (800) 999-CHEV (2438) • www.chevsofthe40s.com**



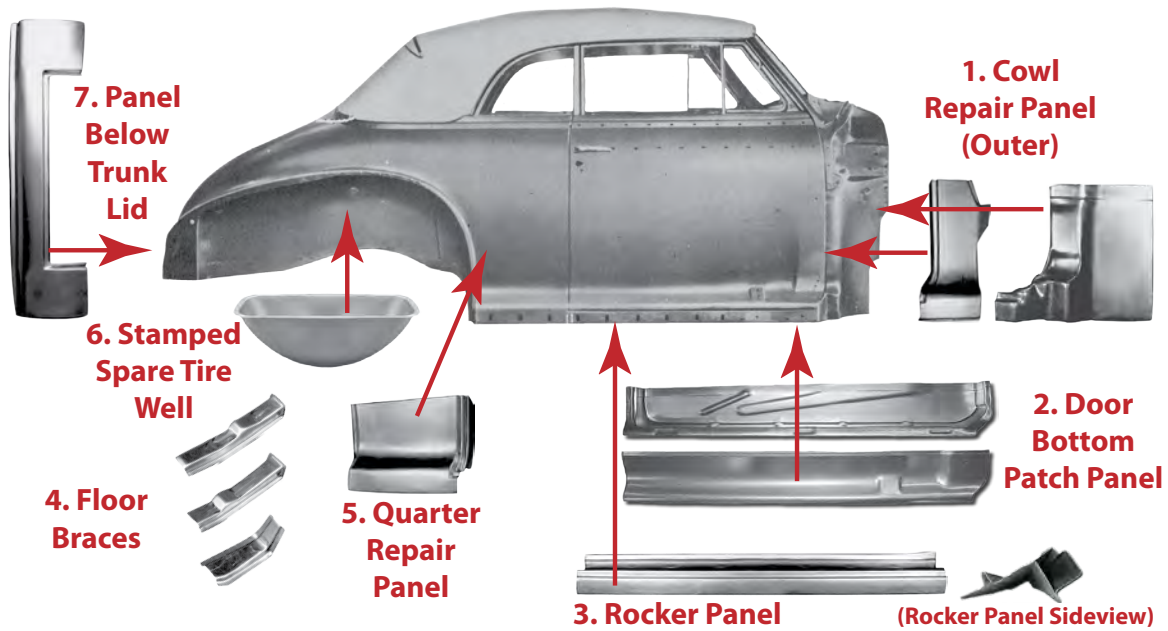

**1. Cowl Repair Panel Outer**

- 4117500ER** ..... **41**  
Die-stamped. Lower front, right.  
(20-1/2" tall) 12.804 -0.15 .. **\$144.75 EA** ⚠
- 4117501EL** ..... **41**  
Die-stamped. Lower front, left. (20-1/2"  
tall) 12.804 -0.15 ..... **\$144.75 EA** ⚠
- 4132430ER** ..... **42-48**  
Die-stamped. Lower front, right  
12.804 -0.15 ..... **\$145.00 EA** ⚠
- 4132431EL** ..... **42-48**  
Die-stamped. Lower front, left 12.804 -0.15  
..... **\$145.00 EA** ⚠

**2. Door Bottom Patch Panel**

- 4114390L** ..... **41**  
Die-stamped. Inner & outer. Fits 2-door,  
left (2 pcs). 10.531 -0.15 .. **\$225.00 SET**  
⚠
- 4114390R** ..... **41**  
Die-stamped. Inner & outer. Fits 2-door,  
right (2 pcs). 10.531 -0.15 . **\$225.00 SET**  
⚠
- 4114390AE** ..... **41-48**  
Die-stamped. Repair panel, right. Inner &  
outer. Aerosedan only. 10.351 -0.15 ....  
**\$225.00 SET** ⚠
- 4114390BE** ..... **41-48**  
Die-stamped. Repair panel, left. Inner &  
outer. Aerosedan only. 10.351 -0.15 ....  
**\$225.00 SET** ⚠
- 4114390CL** ..... **42-48**  
Die-stamped. Inner & outer. Fits Coupe or  
2-door, left (2 pcs). 10.531 -0.15 .....  
**\$284.25 SET** ⚠
- 4114390CR** ..... **42-48**  
Die-stamped. Inner & outer. Fits Coupe or  
2-door, right (2 pcs). 10.531 -0.15 .....  
**\$283.25 SET** ⚠

**3. Rocker Panel Assembly With Floor Braces**

- 4148903A** ..... **41-48**  
Die-stamped. Kit w/ 3 braces (left).  
2-door. 12.934 -0.15 ... **\$319.00 SET** ⚠
- 4148903B** ..... **41-48**  
Die-stamped. Kit w/ 3 braces (right).  
2-door. 12.934 -0.15 ... **\$319.00 SET** ⚠
- 4148903C** ..... **41-48**  
Die-stamped. Kit w/ 3 braces (left)  
4-door. 12.934 -0.15 ... **\$475.00 SET** ⚠
- 4148903D** ..... **41-48**  
Die-stamped. Kit w/ 3 braces (right)  
4-door. 12.934 -0.15 ... **\$471.00 SET** ⚠

**Rocker Panel Extension**

- 4148903** ..... **41-48**  
Die-stamped. Rear extension with top sill.  
Fits 4-door, right or left. 12.934 -0.15 ...  
**\$116.75 EA** ⚠

**4. Floor Braces**

- 4132417FL** ..... **41-48**  
Die-stamped. Front, left. 12.980 -0.15 ...  
**\$97.00 EA** ⚠
- 4132417FR** ..... **41-48**  
Die-stamped. Front, right. 12.980 -0.15 .  
**\$97.00 EA** ⚠
- 4132417M** ..... **41-48**  
Die-stamped. Center (left or right).  
12.980 -0.15 ..... **\$97.00 EA** ⚠
- 4132417R** ..... **41-48**  
Die-stamped. Rear (left or right).  
12.980 -0.15 ..... **\$95.50 EA** ⚠

**5. Quarter Repair Panel**

- 4550592ER** ..... **41-48**  
Die-stamped. Right. 12.944 -0.15 .....  
**\$145.00 EA** ⚠
- 4550593EL** ..... **41-48**  
Die-stamped. Left. 12.944 -0.15 .....  
**\$145.00 EA** ⚠
- 4550595EL** ..... **41-48**  
Die-stamped. Aero, left. 12.944 -0.15 ...  
**\$145.00 EA** ⚠
- 4550596ER** ..... **41-48**  
Die-stamped. Aero, right. 12.944 -0.15 ..  
**\$145.00 EA** ⚠

**6. Spare Tire Well**

- 4562195** ..... **41-54**  
Die-stamped. Replacement. 12.981 -0.15  
..... **\$219.75 EA** ⚠

**7. Panel Below Trunk Lid**

- 4146802A** ..... **41-48**  
Die-stamped. Except Sedan Delivery  
12.966 -0.15 ..... **\$356.75 EA** ⚠

Returns require a return authorization number—call first. • Product pricing & availability subject to change.

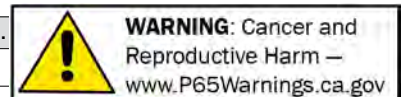

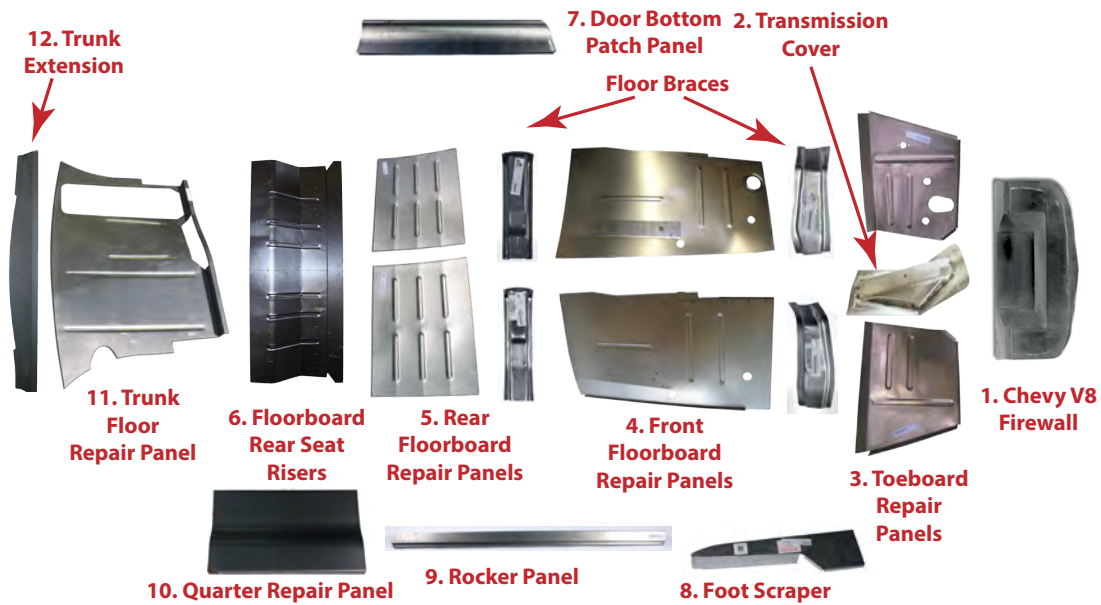

**1. Firewalls For Chevy V8**

- 4117580X48 ... 41-48**  
Small block. 12.803 -0.15  
... **\$382.00 EA** ⚠
- 4117580Y48 ... 41-48**  
Big block. 12.803 -0.15  
... **\$386.00 EA** ⚠

**2. Transmission Cover**

- 3650387V48 ... 41-48**  
Fabricated. For auto transmission.  
12.565 -0.15 ... **\$176.50 EA** ⚠
- 36580870S ... 41-48**  
Trans cover, Automatic Oversized 12.565 -0  
... **\$212.50 EA** ⚠

**3. Toe Board Repair Panel**

- 4132412TL48 ... 41-48**  
Fabricated. Left side. 12.980 -0.15  
... **\$175.00 EA** ⚠
- 4132412TR48 ... 41-48**  
Fabricated. Right side. 12.980 -0.15  
... **\$181.25 EA** ⚠

**4. Floorboard Repair Panels Front**

- 4132412L48 ... 41-48**  
Fabricated. Front left. 12.980 -0.15  
... **\$338.00 EA** ⚠
- 4132412R48 ... 41-48**  
Fabricated. Front right. 12.980 -0.15  
... **\$334.75 EA** ⚠

**Floorboards Front Streetrod**

- 4132412X48 ... 41-48**  
Fabricated. Small block 12.980 -0.15  
... **\$301.75 EA** ⚠
- 4132412Y48 ... 41-48**  
Fabricated. Big block 12.980 -0.15  
... **\$301.75 EA** ⚠
- 4132412Z48 ... 41-48**  
Fabricated. Stock firewall 12.980 -0.15  
... **\$301.75 EA** ⚠

**Floorboards Front Streetrod, cont.**

- 413241CX48 ... 41-48**  
Small block, CBL 12.980 -0.15  
... **\$301.75 EA** ⚠
- 413241CY48 ... 41-48**  
Fabricated. Big block, CBL 12.980 -0.15  
... **\$301.75 EA** ⚠

**Floorboard, Center - Streetrod**

- 4132413V48 ... 41-48**  
Fabricated. 2-door & 4-door sedans.  
12.980 -0 ... **\$468.00 EA** ⚠

**5. Floorboard Repair Panels Rear**

- 4132414L48 ... 41-48**  
Fabricated. Rear left. 12.980 -0.15  
... **\$104.00 EA** ⚠
- 4132414R48 ... 41-48**  
Fabricated. Rear right. 12.980 -0.15  
... **\$104.00 EA** ⚠
- 4132414U48 ... 41-48**  
Fabricated. Cabriolet 12.980 -0  
... **\$395.00 EA** ⚠

**6. Floorboard Rear Seat Riser**

- 4132415 ... 41-48**  
Fabricated. Under rear seat. 12.980 -0.15  
... **\$185.75 EA** ⚠

**7. Door Bottom Patch Panel**

- 4114390A ... 41-48**  
Fabricated. Repair panel, right. 10.351 -0.2  
... **\$55.00 EA** ⚠
- 4114390B ... 41-48**  
Fabricated. Repair panel, outer left.  
10.351 -0.15 ... **\$47.25 EA** ⚠

**8. Foot Scraper Extension**

- 3664353 ... 42-48**  
Fabricated. Left. 8.153 -0.15  
... **\$98.50 EA** ⚠
- 3664354 ... 42-48**  
Fabricated. Right. 8.153 -0.15  
... **\$99.25 EA** ⚠

**Outer Rocker Panel With Threaded Points For Running Board Brackets**

- 4148902 ... 41-48**  
Fabricated. Rocker panel, outer  
12.934 -0.15 ... **\$36.75 EA** ⚠

**Inner Rocker Panel**

- 4132450 ... 41-48**  
Fabricated. Inner repair 12.934 -0.3  
... **\$42.75 EA** ⚠

**10. Quarter Repair Panel**

- 4550592 ... 41-48**  
Fabricated. Left or Right. Lower (forward  
of wheel well). 12.944 -0.15  
... **\$35.00 EA** ⚠

**11. Trunk Floorboards**

- 4117487 ... 41-48**  
1 piece w/o spare tire well. 12.981 -0.15  
... **\$370.00 EA** ⚠
- 4117487S ... 41-48**  
Fabricated. 1 piece with spare tire well  
cut-out. 12.981 -0.15  
... **\$392.00 SET** ⚠
- 4117487T48 ... 41-48**  
Fabricated. Coupe, Sedan & Cabriolet.  
Includes braces to support the trunk floor.  
12.980 -0.15 ... **\$225.50 EA** ⚠

**12. Trunk Extension**

- 4146802 ... 41-48**  
Fabricated. save pocket from trunk latch  
area (will fit stock trunks) 12.966 -0.15  
... **\$173.00 EA** ⚠

**Complete Floor Pan**

- C5FLOOR ... 41-48**  
Complete floorboard for 1941-48 cars  
with C5 rear subframe. The driveline  
tunnel is large enough to fit over C5  
torque tube. -0.2 ... **\$2,500.00 EA** ⚠

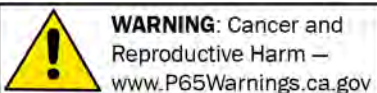

Chemicals shipped domestic ground only (Lower 48 states only). No international shipping.

**Phone: (360) 816-0211 • (800) 999-CHEV (2438) • www.chevsofthe40s.com**



# Section 295C: Sheet Metal 1949-52 Die Stamped Body Parts

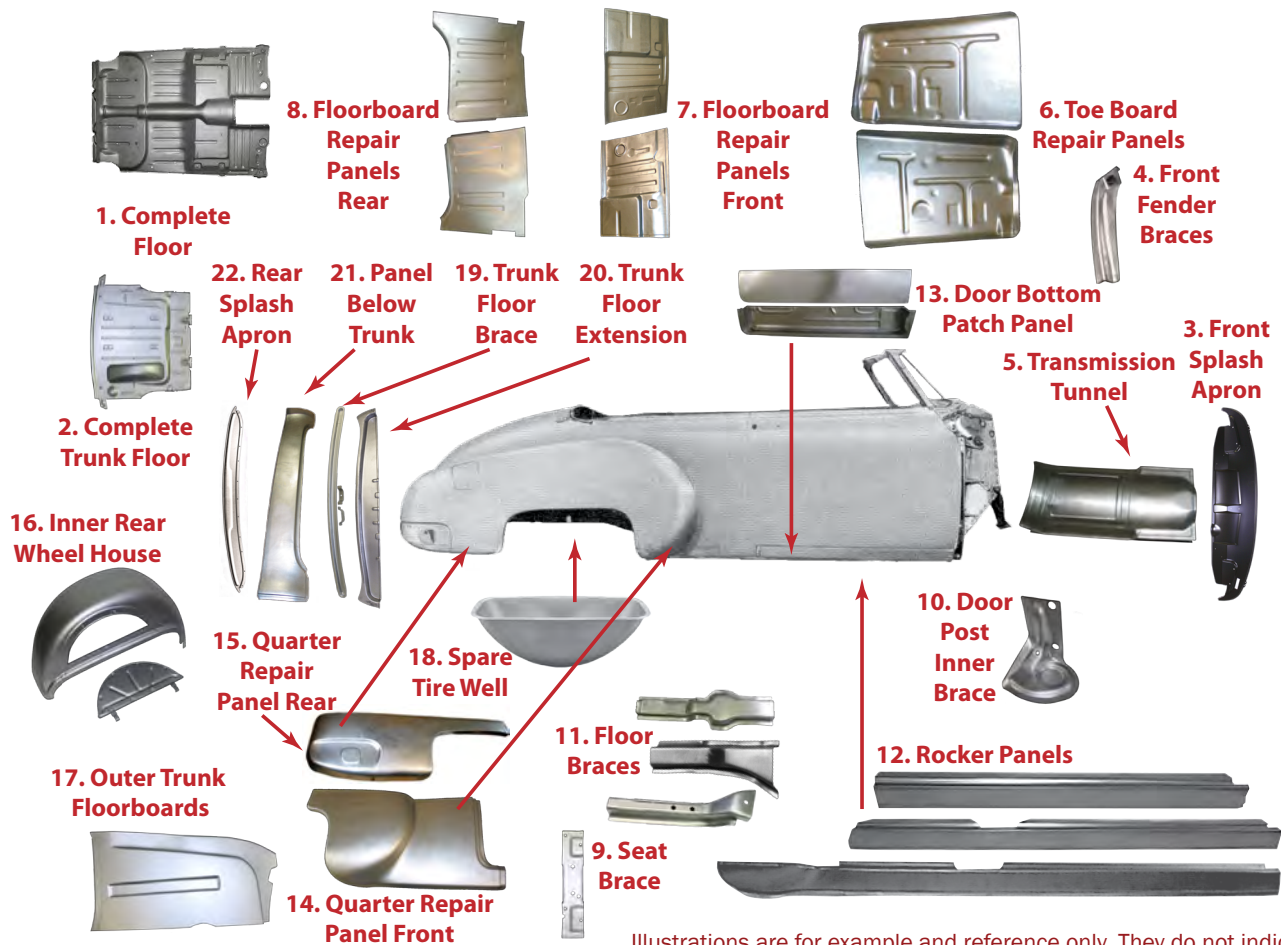

Illustrations are for example and reference only. They do not indicate that we have all the parts shown. Oversize shipping charges may apply to some sheetmetal parts. Please call for rate.

## 1. Complete Floor With Braces

**4132419** ..... 49-52  
Die-stamped. COMPLETE!!! Firewall to trunk floor. 12.980-0 ..... **\$1,262.75 EA** ⚠

## 2. Complete Trunk Floor With Braces

**4600011** ..... 49-52  
Die-stamped. COMPLETE!!! Braces and all. Ready to install. 12.981-0 **CALL** ⚠

## 3. Front Splash Apron

**3688439** ..... 49-50  
Die-stamped. Steel. 1.287-0 ..... **\$278.25 EA** ⚠

**3694899** ..... 51-52  
Front Splash Apron (Used) 1.287-0 ... **\$280.25 EA** ⚠

## 4. Front Fender Brace

**3700393A** ..... 49-52  
Die-stamped. Fender brace for rear of front left fender. Made in the USA.

8.153-0.15 ..... **\$61.75 EA** ⚠

**3700394A** ..... 49-52  
Die-stamped. Fender brace for rear of front right fender. Made in the USA.

8.153-0.15 ..... **\$61.75 EA** ⚠

## 5. Transmission Tunnel

**3688985** ..... 49-52  
Die-stamped. 12.565-0.15 ..... **\$204.00 EA** ⚠

## 6. Toe Board Repair Panel

**4132412TL52** ..... 49-52  
Die-stamped. Left. 12.980-0.15 ..... **\$134.75 EA** ⚠

**4132412TR52** ..... 49-52  
Die-stamped. Right. 12.980-0.15 ..... **\$134.75 EA** ⚠

## 7. Floorboard Repair Panels Front

**4132412EL52** ..... 49-52  
Die-stamped. Left. Front. Replaces from the bottom of the toe board rearward to about the back of the front seat. 12.980-0.15 ..... **\$190.00 EA** ⚠

**4132412ER52** ..... 49-52  
Die-stamped. Right. Front. Replaces from the bottom of the toe board rearward to about the back of the front seat. 12.980-0.15 ..... **\$192.50 EA** ⚠

**4132412L52** ..... 49-52  
Die-stamped. Front, left. 12.980-0.15 ... **\$149.75 EA** ⚠

## 7. Floorboard Repair Panels Front, cont.

**4132412R52** ..... 49-52  
Die-stamped. Front, right. 12.980-0.15 ..... **\$149.75 EA** ⚠

## 8. Floorboard Repair Panels Rear

**4132414L52E** ..... 49-52  
Die-stamped. Left. Rear (rocker to center). Replaces from a few inches under the front seat rearward to just under the rear seat. 12.980-0.15 ..... **\$257.50 EA** ⚠

**4132414R52E** ..... 49-52  
Die-stamped. Right. Rear (rocker to center). Replaces from a few inches under the front seat rearward to just under the rear seat. 12.980-0.15 ..... **\$219.75 EA** ⚠

## 9. Seat Brace

**4132419AL** ..... 49-52  
Die-stamped. Left side. Welds to floor. 12.980-0.15 ..... **\$85.25 EA** ⚠

**4132419AR** ..... 49-52  
Die-stamped. Right side. Welds to floor. 12.980-0.15 ..... **\$85.25 EA** ⚠

Returns require a return authorization number—call first. • Product pricing & availability subject to change.

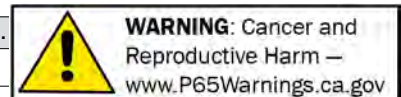

**10. Door Post Inner Brace**

**4563355** ..... **49-52**  
Die-stamped. Front, right. 12.934-0.15 ..  
**\$91.00 EA** ⚠️  
**4563356** ..... **49-52**  
Die-stamped. Front, left. 12.934-0.15 ...  
**\$91.00 EA** ⚠️

**11. One Piece Floor Braces**

**4132417GO** ..... **49-52**  
Die-stamped. One Piece Front. 12.980-0.15  
..... **\$196.00 EA** ⚠️  
**4132417HO** ..... **49-52**  
Die-stamped. One Piece Center.  
12.980-0.15 ..... **\$195.50 EA** ⚠️  
**4132417IO** ..... **49-52**  
Die-stamped. One Piece Rear. 12.980-0.15  
..... **\$196.00 EA** ⚠️

**Short Floor Braces**

**4132417EL** ..... **49-52**  
Die-stamped. Left front attaching to cowl  
post. 12.840-0.15 ..... **\$110.25 EA** ⚠️  
**4132417ER** ..... **49-52**  
Die-stamped. Right front attaching to cowl  
post. 12.803-0.15 ..... **\$110.25 EA** ⚠️  
**4132417G** ..... **49-52**  
Die-stamped. Front. Left or right side.  
12.980-0.15 ..... **\$91.00 EA** ⚠️  
**4132417HL** ..... **49-52**  
Die-stamped. Center, left 12.980-0.15 ..  
**\$117.25 EA** ⚠️  
**4132417HR** ..... **49-52**  
Die-stamped. Center, right 12.980-0.15  
**\$117.25 EA** ⚠️  
**4132417IL** ..... **49-52**  
Die-stamped. Rear, left. 12.980-0.15 ...  
**\$92.00 EA** ⚠️  
**4132417IR** ..... **49-52**  
Die-stamped. Rear, right. 12.980-0.15 ..  
**\$91.00 EA** ⚠️

**12. Rocker Panels**

**4169444AE** ..... **49-52**  
Die-stamped. Right. Rear door 4-door.  
12.934-0 ..... **\$139.25 EA** ⚠️  
**4169445AE** ..... **49-52**  
Die-stamped. Left. Rear door 4-door.  
12.934-0 ..... **\$139.25 EA** ⚠️  
**4169446AE** ..... **49-52**  
Die-stamped. Right. Front door 4-door.  
12.934-0 ..... **\$104.00 EA** ⚠️  
**4169447AE** ..... **49-52**  
Die-stamped. Left. Front door 4-door.  
12.934-0 ..... **\$104.00 EA** ⚠️  
**4169448AE** ..... **49-52**  
Die-stamped. Right. 2-Door. 12.934-0.15  
..... **\$139.00 EA** ⚠️  
**4169449AE** ..... **49-52**  
Die-stamped. Left. 2-Door. 12.934-0.15  
**\$176.75 EA** ⚠️

**Inner Rocker Panel**

**4563812T52** ..... **49-52**  
Inner rocker 45" x 4". 12.934-0.15 .....  
**\$59.00 EA** ⚠️

**13. Door Bottom Patch Panel**

**4184838CR** ..... **49-52**  
Die-stamped. Inner & outer, Coupe &  
2-DR, right (2 pcs). 10.531-0.15 .....  
**\$224.50 SET** ⚠️  
**4184838HR** ..... **49-52**  
Die-stamped. Inner & outer, convertible &  
hardtop, right (2 pcs). 10.531-0 .....  
**\$224.50 SET** ⚠️  
**4184839CL** ..... **49-52**  
Die-stamped. Inner & outer, Coupe &  
2-DR, left (2 pcs). 10.531-0.15 .....  
**\$224.50 SET** ⚠️  
**4184839HL** ..... **49-52**  
Die-stamped. Inner & outer, convertible &  
hardtop, left (2 pcs). 10.531-0 .....  
**\$224.50 SET** ⚠️

**14. Quarter Repair Panel Front**

**4613848AE** ..... **49-52**  
Die-stamped. Front of rear fender, left.  
Superior. 12.940-0.15 ..... **\$219.75 EA** ⚠️  
**4613848BE** ..... **49-52**  
Die-stamped. Front of rear fender, right.  
Superior. 12.940-0.15 ..... **\$256.50 EA** ⚠️  
**4613848CE** ..... **49-52**  
Die-stamped. Right, front of rear fender,  
Hardtop & Conv. Superior. 12.940-0.15  
**\$256.50 EA** ⚠️  
**4613848DE** ..... **49-52**  
Die-stamped. Left, front of rear fender,  
Hardtop & Conv. Superior. 12.940-0.15  
**\$204.00 EA** ⚠️

**15. Quarter Repair Panel Rear**

**4585715E** ..... **49-50**  
Die-stamped. Lower rear, right. Superior.  
12.944-0.15 ..... **\$256.50 EA** ⚠️  
**4585716E** ..... **49-50**  
Die-stamped. Lower rear, left. Superior.  
12.944-0.15 ..... **\$256.50 EA** ⚠️  
**4586788E** ..... **51-52**  
Die-stamped. Lower rear, right. Superior.  
12.944-0.15 ..... **\$195.00 EA** ⚠️  
**4586789E** ..... **51-52**  
Die-stamped. Lower rear, left. Superior.  
12.944-0.15 ..... **\$256.50 EA** ⚠️

**16. Inner Rear Wheel House**

**4562603** ..... **49-50**  
Die-stamped. 2 Door Right side rear inner  
wheel house. 12.941-0.15 ..... **\$336.50 EA**  
⚠️  
**4562604** ..... **49-50**  
Die-stamped. 2 Door Left side rear inner  
wheel house. 12.941-0.15 ..... **\$336.50 EA**  
⚠️

**17. Outer Trunk Floorboards**

**4575794** ..... **49-50**  
Die-stamped. Outer floor section for the  
trunk. Right hand side. 12.981-0.15 ...  
**\$95.75 EA** ⚠️  
**4582083** ..... **49-50**  
Die-stamped. Outer floor section for the  
trunk. Left hand side, has the hole for  
the filler neck. 12.981-0.15 ..... **\$95.75 EA**  
⚠️

**18. Spare Tire Well**

**4562195** ..... **41-54**  
Die-stamped. Replacement. 12.981-0.15  
..... **\$219.75 EA** ⚠️

**19. Trunk Floor Rear Brace**

**4589464A** ..... **49-52**  
Die-stamped. Rear Brace 12.981-0.15  
..... **\$115.00 EA** ⚠️

**20. Trunk Floor Extension**

**4589464AE** ..... **49-52**  
Die-stamped. 2 door Coupe/ Sedan  
12.981-0.15 ..... **\$173.00 EA** ⚠️

**21. Panel Below Trunk Lid**

**4584477** ..... **49-50**  
Die-stamped. Sedan. 12.966-0.15 .....  
**\$357.00 EA** ⚠️  
**4584482** ..... **49-50**  
Die-stamped. Fleetline Fastback. Steel.  
01A.10.B  
-0.15 ..... **\$356.75 EA** ⚠️  
**4584488** ..... **49-52**  
Die-stamped. Sedan Delivery. 12.966-0.15  
..... **\$454.25 EA** ⚠️  
**4588359** ..... **51-52**  
Die-stamped. Sedan/ Coupe. Center  
section, just less than trunk lid width.  
12.966-0.15 ..... **\$322.50 EA** ⚠️  
**4588360** ..... **51-52**  
Die-stamped. Fleetline Fastback. Center  
section, just less than trunk lid width.  
12.966-0.15 ..... **\$255.00 EA** ⚠️

**22. Rear Splash Apron**

**3689015** ..... **49-52**  
Rear splash apron to bumper. 49-50(EXC  
Station Wagon) 51-52 Sedan Delivery  
only. 7.833-0.15 ..... **\$231.50 EA** ⚠️  
**3694925** ..... **51-52**  
Rear splash apron (Used). 7.833-0.15 ....  
**\$232.50 EA** ⚠️  
**EMS354** ..... **51-52**  
License light delete plate for 51-52 rear  
splash apron. -0.15 ..... **\$19.00 EA** ⚠️

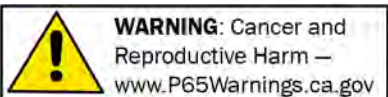

Chemicals shipped domestic ground only (Lower 48 states only). No international shipping.

**Phone: (360) 816-0211 • (800) 999-CHEV (2438) • www.chevsofthe40s.com**





Illustrations are for example and reference only. They do not indicate that we have all the parts shown.

Oversize shipping charges may apply to some sheetmetal parts. Please call for rate.

|  |                     |
|--|---------------------|
| <b>4132412L</b> .....                  | <b>49-52</b>        |
| Door Post Brace Lower Left 1/8" Steel  |                     |
| 12.980 -0 .....                        | <b>\$98.00 EA</b> ⚠ |
| <b>4132412R</b> .....                  | <b>49-52</b>        |
| Door Post Brace Lower Right 1/8" Steel |                     |
| 12.980 -0 .....                        | <b>\$98.00 EA</b> ⚠ |

|   |                      |
|---|----------------------|
| <b>1. Firewalls for Chevy V8</b>  |                      |
| <b>4613220X52</b> .....   | <b>49-52</b>         |
| Small block or big block. 12.803 -0.15                                    |                      |
|   | <b>\$449.00 EA</b> ⚠ |
| <b>4613220XT52</b> .....  | <b>49-52</b>         |
| Tapered for use with brake booster Small block or big block. 12.803 -0.15 |                      |
|   | <b>\$452.25 EA</b> ⚠ |

|  |                     |
|--|---------------------|
| <b>2. Air Duct</b>                     |                     |
| <b>3688772</b> .....                   | <b>49-52</b>        |
| Below battery. Right side. 12.803 -0.3 |                     |
|  | <b>\$44.75 EA</b> ⚠ |

|  |               |
|--|---------------|
| <b>3. Patch Panel Lower Rear Of Front Fender</b> |               |
| <b>3690631A</b> .....                            | <b>49-52</b>  |
| Die-stamped. Left. 12.944 -0                     |               |
|  | <b>CALL</b> ⚠ |
| <b>3690632A</b> .....                            | <b>49-52</b>  |
| Die-stamped. Right. 12.944 -0                    |               |
|  | <b>CALL</b> ⚠ |

|  |                      |
|--|----------------------|
| <b>Floorboards Front Streetrod</b>                                 |                      |
| <b>4583665X52</b> .....  | <b>49-52</b>         |
| Bitchen Style. Small or big block, to rear seat riser 12.980 -0.15 |                      |
|  | <b>\$334.75 EA</b> ⚠ |

|   |                      |
|---|----------------------|
| <b>4. Rear Floorboard Repair Panels</b> |                      |
| <b>4132414L52</b> .....                 | <b>49-52</b>         |
| Fabricated. Rear, left. 12.980 -0.15    |                      |
|   | <b>\$224.25 EA</b> ⚠ |
| <b>4132414R52</b> .....                 | <b>49-52</b>         |
| Fabricated. Rear, right. 12.980 -0.15   |                      |
|   | <b>\$239.25 EA</b> ⚠ |

|   |                   |
|---|-------------------|
| <b>5. Sedan Delivery Floor Repair Panel</b>   |                   |
| <b>4627043C</b> .....   | <b>49-54</b>      |
| Fabricated. From behind drivers seat back to rear cargo door. Sedan Delivery only. Made in the USA 12.981 -0.15 |                   |
|   | <b>\$387.00</b> ⚠ |

|   |               |
|---|---------------|
| <b>6. Trunk Floor Repair Panels</b>                               |               |
| <b>4589464</b> .....  | <b>49-52</b>  |
| Fabricated. Except Wagon & Sedan Delivery (2-piece set) 12.981 -0 |               |
|   | <b>CALL</b> ⚠ |

|  |                   |
|--|-------------------|
| <b>7. Floor Support Brackets</b>                               |                   |
| <b>4627043A</b> .....  | <b>49-54</b>      |
| Fabricated. Sedan Delivery load support brackets. 12.981 -0.15 |                   |
|  | <b>\$157.00</b> ⚠ |

|   |                      |
|---|----------------------|
| <b>8. Outer Rocker Panel</b>                  |                      |
| <b>4169448</b> .....                          | <b>49-52</b>         |
| Fabricated. Right side 4-Door. 12.934 -0.15   |                      |
|   | <b>\$218.00 EA</b> ⚠ |
| <b>4169448A</b> .....                         | <b>49-52</b>         |
| Fabricated. Right. 2-Door. 12.934 -0.15       |                      |
|   | <b>\$100.00 EA</b> ⚠ |
| <b>4169448C</b> .....                         | <b>49-52</b>         |
| Fabricated. Right. Front 4-Door. 12.934 -0.15 |                      |
|   | <b>\$111.00 EA</b> ⚠ |

|  |                      |
|--|----------------------|
| <b>8. Outer Rocker Panel, cont.</b>          |                      |
| <b>4169449</b> .....                         | <b>49-52</b>         |
| Fabricated. Left. side 4-Door. 12.934 -0.15  |                      |
|  | <b>\$218.00 EA</b> ⚠ |
| <b>4169449A</b> .....                        | <b>49-52</b>         |
| Fabricated. Left. 2-Door. 12.934 -0.15       |                      |
|  | <b>\$99.75 EA</b> ⚠  |
| <b>4169449C</b> .....                        | <b>49-52</b>         |
| Fabricated. Left. Front 4-Door. 12.934 -0.15 |                      |
|  | <b>\$111.00 EA</b> ⚠ |

|                                  |                     |
|----------------------------------|---------------------|
| <b>9. Inner Rocker Panel</b>     |                     |
| <b>4169448G</b> .....            | <b>49-52</b>        |
| Inner repair panel. 65 x 3 15/16 |                     |
| Fabricated 12.934 -0.3           |                     |
|                                  | <b>\$86.25 EA</b> ⚠ |

|  |                     |
|--|---------------------|
| <b>10. Rocker Panel Extension</b>            |                     |
| <b>4169448E</b> .....                        | <b>49-52</b>        |
| Fabricated. Right. Rear 4-Door. 12.934 -0.15 |                     |
|  | <b>\$75.00 EA</b> ⚠ |
| <b>4169449E</b> .....                        | <b>49-52</b>        |
| Fabricated. Left. Rear 4-Door. 12.934 -0.15  |                     |
|  | <b>\$63.25 EA</b> ⚠ |

|  |                     |
|--|---------------------|
| <b>11. Quarter Repair Panel</b>                    |                     |
| <b>4560534</b> .....                               | <b>49-52</b>        |
| Stamped economy. Lower rear, right. 12.944 -0.15   |                     |
|  | <b>\$96.00 EA</b> ⚠ |
| <b>4613848B</b> .....                              | <b>49-52</b>        |
| Fabricated. Front of rear fender, right. 12.940 -0 |                     |
|  | <b>CALL</b> ⚠       |

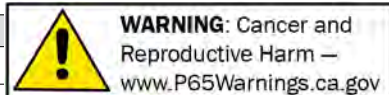

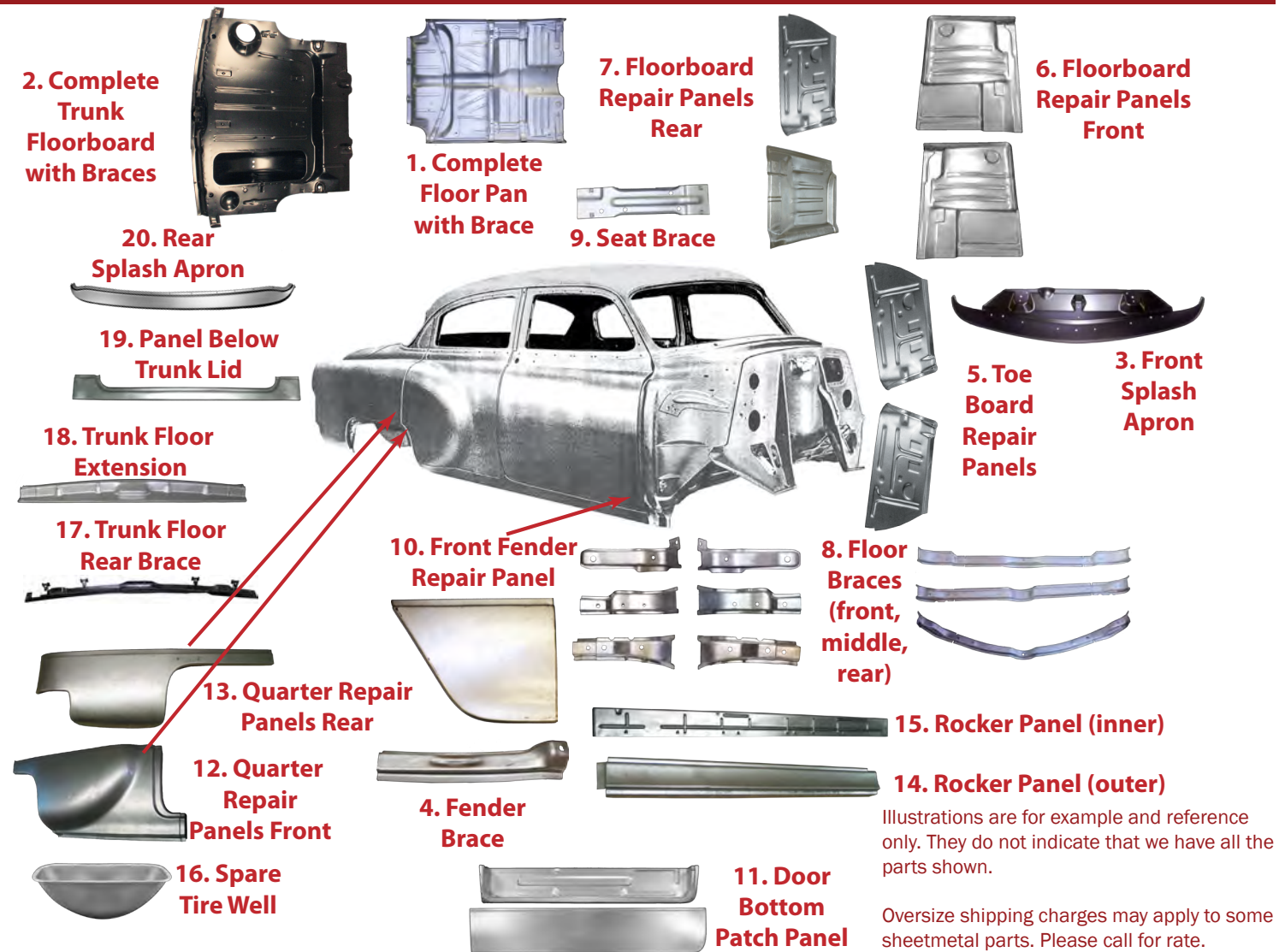

Illustrations are for example and reference only. They do not indicate that we have all the parts shown.

Oversize shipping charges may apply to some sheetmetal parts. Please call for rate.

- 1. Complete Floor Pan With Brace**  
4643428 ..... 53-54  
Die-stamped. COMPLETE!!! Firewall to trunk. 12.980-0 ..... **\$1,283.50 EA** ⚠
- 2. Complete Trunk Floorboard With Braces**  
4600012 ..... 53-54  
Die-stamped. COMPLETE!!! Braces and all. Ready to install. 12.981-0.15 ..... **\$1,047.75 EA** ⚠
- 3. Front Splash Apron**  
3697958 ..... 53  
Die-stamped Steel. 1.287-0.15 ..... **\$301.75 EA** ⚠
- 4. Fender Brace**  
3705136A ..... 53-54  
Die-stamped. Fender brace for rear of front right fender. Supports fender, bolts to the bottom of the body. 8.153-0.15 ... **\$50.00 EA** ⚠

- 4. Fender Brace, cont.**  
3707847A ..... 53-54  
Die-stamped. Fender brace for rear of front left fender. Supports the fender, bolts in the bottom of the body. 8.153-0.15 ..... **\$50.00 EA** ⚠
- 5. Toe Board Repair Panel**  
4638105A ..... 53-54  
Die-stamped. Left. 12.803-0.15 ..... **\$122.00 EA** ⚠  
4638106A ..... 53-54  
Die-stamped. Right. 12.803-0.15 ..... **\$123.00 EA** ⚠
- 6. Floorboard Repair Panels Front**  
4132412EL54 ..... 53-54  
Die-stamped. Front left. Replaces from the bottom of the toe board rearward to about the back of the front seat. 12.980-0.15 ..... **\$204.00 EA** ⚠

- 6. Floorboard Repair Panels Front, cont.**  
4132412ER54 ..... 53-54  
Die-stamped. Front right. Replaces from the bottom of the toe board rearward to about the back of the front seat. 12.980-0.15 ..... **\$255.50 EA** ⚠  
4132412L54 ..... 53-54  
Die-stamped. Front left. 12.980-0.15 ... **\$123.00 EA** ⚠  
4132412R54 ..... 53-54  
Die-stamped. Front right. 12.980-0.15 .. **\$136.00 EA** ⚠
- 7. Floorboard Repair Panels Rear**  
4132414EL54 ..... 53-54  
Die-stamped. Superior. Rear left. Replaces a few inches forward of the front seat rearward to just under the rear seat. 12.980-0.15 ..... **\$204.00 EA** ⚠

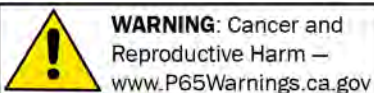

Chemicals shipped domestic ground only (Lower 48 states only). No international shipping.

**Phone: (360) 816-0211 • (800) 999-CHEV (2438) • www.chevsofthe40s.com**



**7. Floorboard Repair Panels Rear, cont.**

- 4132414ER54** ..... 53-54  
Die-stamped. Superior. Rear right.  
Replaces a few inches forward of the front seat rearward to just under the rear seat.  
12.980 -0.15 ..... **\$204.00 EA** ⚠
- 4132414L54** ..... 53-54  
Die-stamped. Rear left. 12.980 -0.15 .....  
**\$131.00 EA** ⚠
- 4132414R54** ..... 53-54  
Die-stamped. Rear right. 12.980 -0.15 ..  
**\$123.00 EA** ⚠

**8. One Piece Floor Braces**

- 4132417FO** ..... 53-54  
Front one piece 12.980 -0.15 ..... **\$178.00 EA** ⚠
- 4132417MO** ..... 53-54  
Middle one piece 12.980 -0.15 .....  
**\$156.00 EA** ⚠
- 4132417RO** ..... 53-54  
Rear one piece 12.980 -0.15 ..... **\$247.25 EA** ⚠

**8. Floor Braces Short Left And Right**

- 4132417HC** ..... 49-54  
Convertible & Hardtop 4th row, fits left or right. -0.15 ..... **\$119.50 EA** ⚠
- 4132417JL** ..... 53-54  
Die-stamped. Front, left. 1st row  
12.980 -0.15 ..... **\$92.00 EA** ⚠
- 4132417JR** ..... 53-54  
Die-stamped. Front, right. 1st row  
12.980 -0.15 ..... **\$92.00 EA** ⚠
- 4132417KL** ..... 53-54  
Die-stamped. Center, left. 2nd row.  
12.980 -0.15 ..... **\$93.00 EA** ⚠
- 4132417KR** ..... 53-54  
Die-stamped. Center, right. 2nd row  
12.980 -0.15 ..... **\$93.00 EA** ⚠
- 4132417LL** ..... 53-54  
Die-stamped. Rear Left. 3rd row  
12.980 -0.15 ..... **\$92.00 EA** ⚠
- 4132417LR** ..... 53-54  
Die-stamped. Rear right. 3rd row  
12.980 -0.15 ..... **\$92.00 EA** ⚠
- 4132417ML** ..... 53-54  
Die-stamped. Rear Left. 4th row  
12.980 -0.15 ..... **\$118.50 EA** ⚠
- 4132417MR** ..... 53-54  
Die-stamped. Right. 4th row 12.980 -0.15 .....  
**\$118.50 EA** ⚠
- 4132417UC** ..... 53-54  
Upper Cup Floor Brace Hardtop & Convertible. Fits on top of the rear floor pan and connects to the 4th row floor braces through the rear floor pan. -0.15 .....  
**\$84.00 EA** ⚠

**9. Seat Brace**

- 4643428AL** ..... 53-54  
Die-stamped. Left side. Welds to floor.  
12.980 -0.15 ..... **\$120.75 EA** ⚠
- 4643428AR** ..... 53-54  
Die-stamped. Right side. Welds to floor.  
12.980 -0.15 ..... **\$120.75 EA** ⚠

**Rear Door Post Reinforcement Plate**



**4132417PL** ..... 53-54  
The hardtop/convertible cars have a special set of reinforcement

brackets near the rear door post consisting of a series of braces, this door post reinforcement plate is part of that.

Made in USA! 11 gauge steel -0.15 .....  
**\$122.00 EA** ⚠



**4132417PR** ..... 53-54  
The hardtop and convertible cars have a special set of

reinforcement brackets near the rear door post consisting of a series of braces, this door post reinforcement plate is part of that.

Made in USA! 11 gauge steel -0.15 .....  
**\$122.00 EA** ⚠

**10. Front Fender Repair Panel**

- 3704393A** ..... 53-54  
Die-stamped. Repair lower section front of left front fender 8.130 -0.15 ... **\$93.00 EA** ⚠
- 3704394A** ..... 53-54  
Die-stamped. Repair lower section front of right front fender 8.130 -0.15 . **\$93.00 EA** ⚠

**11. Door Bottom Patch Panel**

- 4200414AE** ..... 53-54  
Die-stamped. Right. Inner & outer. 2 Door cars only 10.351 -0.15 ... **\$225.00 SET** ⚠
- 4200415AE** ..... 53-54  
Die-stamped. Left. Inner & outer. 2 Door cars only 10.351 -0.15 ... **\$225.00 SET** ⚠

**12. Quarter Repair Panel Front**

- 4191845S** ..... 53-54  
Die-stamped. Right, 2-door. Door post to center of wheel well. 12.940 -0.15 .....  
**\$256.50 EA** ⚠
- 4191846S** ..... 53-54  
Die-stamped. Left, 2-door. Door post to center of wheel well. 12.940 -0.15 .....  
**\$204.00 EA** ⚠

**13. Quarter Repair Panel Rear**

- 4191843E** ..... 53-54  
Die-stamped. Lower rear, right. 12.944 -0.15 .....  
**\$199.50 EA** ⚠
- 4191844E** ..... 53-54  
Die-stamped. Lower rear, left. 12.944 -0.15 .....  
**\$199.50 EA** ⚠
- 4611976** ..... 53-54  
Die-stamped. Inner rear quarter repair panel, right side. Trunk drop off  
12.944 -0.15 ..... **\$172.00 EA** ⚠
- 4611977** ..... 53-54  
Die-stamped. Inner rear quarter repair panel, left side. Trunk drop off 12.944 -0.15 .....  
**\$172.00 EA** ⚠

**14. Rocker Panel Two Door Outer**

- 4633252** ..... 53-54  
Die-stamped. Right outer 12.934 -0.15 .....  
**\$150.75 EA** ⚠
- 4633253** ..... 53-54  
Die-stamped. Left outer 12.934 -0.15 ...  
**\$176.75 EA** ⚠

**15. Rocker Panel Two Door Inner**

- 4594484** ..... 53-54  
Die-stamped. Right. 12.934 -0.15 .....  
**\$165.00 EA** ⚠
- 4594485** ..... 53-54  
Die-stamped. Left. 69-1/2" length.  
12.934 -0 ..... **\$157.75 EA** ⚠

**16. Spare Tire Well**

- 4562195** ..... 41-54  
Die-stamped. Replacement. 12.981 -0.15 .....  
**\$219.75 EA** ⚠

**17. Trunk Floor Rear Brace**

- 4597485** ..... 53-54  
Die-stamped. Rear Brace 12.981 -0.15 .....  
**\$179.25 EA** ⚠

**18. Trunk Floor Extension**

- 4600012A** ..... 53-54  
Die-stamped. 12.981 -0.15 ..... **\$222.25 EA** ⚠

**19. Panel Below Trunk Lid**

- 4629827** ..... 53-54  
Die-stamped 53-54 (exc SDL & WGN).  
12.966 -0.15 ..... **\$318.25 EA** ⚠

**20. Rear Splash Apron**

- 3702008** ..... 53-54  
Die-stamped. Rear splash apron, exc Station Wagon & Sedan Delivery  
7.833 -0.15 ..... **\$229.00 EA** ⚠

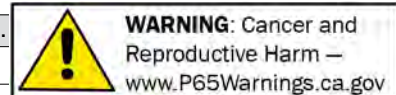



**6. Panel Below Trunk Lid**  
**5. Trunk Floor Repair Panels**

**3. Floor Support Brackets**



**1. Rocker Panel Inner**



**Universal Battery Boxes**

**2. Sedan Delivery Floor Repair Panels**



**4. Quarter Repair Panels**

Illustrations are for example and reference only. They do not indicate that we have all the parts shown.

Oversize shipping charges may apply to some sheetmetal parts. Please call for rate.

**1. Rocker Panel 2 And 4 Door Inner**

- 4594484FE** ..... **53-54**  
Fabricated. Right, Inner front. 12.934 -0.15  
..... **\$74.25 EA** ⚠
- 4594485FE** ..... **53-54**  
Fabricated. Left, Inner front. 12.934 -0.15  
..... **\$72.75 EA** ⚠

**Rocker Patch Panel Inner Front Quarter**

- 4594484RFE** ..... **53-54**  
Fabricated. Inner right front of 1/4 panel closes off the back of the lower 1/4 panel. 12.934 -0.15 ..... **\$48.00 EA** ⚠
- 4594485RFE** ..... **53-54**  
Fabricated. Inner left front of 1/4 panel closes off the back of the lower 1/4 panel. 12.934 -0.15 ..... **\$48.00 EA** ⚠

**Floor Rear Left And Right with Tunnel**

- 4643428X54** ..... **53-54**  
Street rod Style. 12.980 -0.15 ..... **\$334.75 EA** ⚠

**2. Sedan Delivery Floor Repair Panel**

- 4627043C** ..... **49-54**  
Fabricated. From behind drivers seat back to rear cargo door. Sedan Delivery only. Made in the USA 12.981 -0.15 .. **\$387.00** ⚠

**3. Floor Support Brackets**

- 4627043A** ..... **49-54**  
Fabricated. Sedan Delivery load support brackets. 12.981 -0.15 ..... **\$157.00** ⚠

**4. Quarter Repair Panel**

- 4191844** ..... **53-54**  
Fabricated. Lower rear, left. 12.944 -0.15  
..... **\$106.25 EA** ⚠
- 4191845** ..... **53-54**  
Fabricated. Front of rear fender. Right side. 12.940 -0.15 ..... **\$42.00 EA** ⚠
- 4191846** ..... **53-54**  
Fabricated. Front of rear fender. Left side. 12.940 -0.15 ..... **\$42.00 EA** ⚠

**5. Trunk Floor Repair Panels**

- 4600012SR** ..... **53-54**  
Fabricated. Except Wagon & Sedan Delivery 12.981 -0.15 .. **\$235.50 SET** ⚠

**6. Panel Below Trunk Lid**

- 4629827L** ..... **53-54**  
Fabricated. Left side. All exc SDL & WGN. 36" length. 12.966 -0.15 .. **\$24.00 EA** ⚠
- 4629827R** ..... **53-54**  
Fabricated. Right side. All exc SDL & WGN. 36" length. 12.966 -0.15 ..... **\$24.00 EA** ⚠

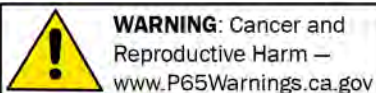

Chemicals shipped domestic ground only (Lower 48 states only). No international shipping.

**Phone: (360) 816-0211 • (800) 999-CHEV (2438) • www.chevsofthe40s.com**



Pricing and details for these items can be found in the following Sections Listed

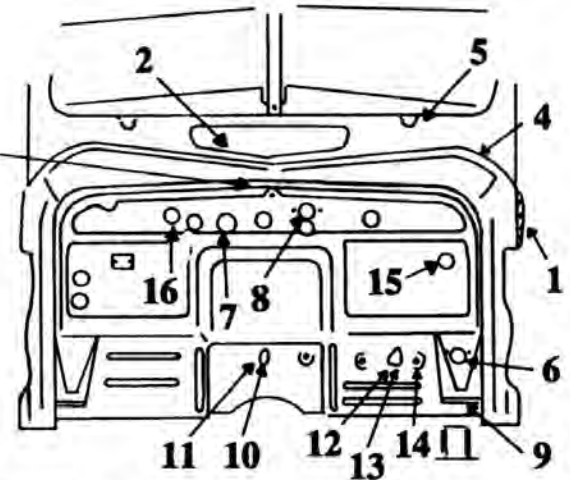

1. 3663805  
42-48 Hood to Side of Cowl Seal  
Section 250C



2. 4081958  
37-48 Cowl Vent Gasket  
Section 370C



3. 3681751C  
41-48 Top/ 41-54 Cowl Plug  
Section 310C



4. Hood to Cowl Seal  
Section 250C



5. Wiper Transmission Gasket  
Section 370C



6. 3653684  
39-48 Emergency Brake  
Rod Grommet  
Section 310C



7. 3681096B  
37-46 Ignition Cable  
Grommet  
Section 310C



8. 3653785  
40-48 Temp/ Oil Pressure  
Throttle Grommet  
Section 310C



9. Body Mount Pads  
Section 300C



10. 597434  
38-48 Starter Bellows Boot  
Section 320C



11. 3654134  
38-48 Starter Rubber Button  
Section 320C



12. Steering Column  
Seal at Firewall  
Section 310C



13. Steering Column  
Grommet at Firewall  
Section 310C

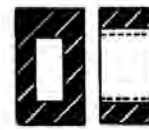

14. 3653388  
39-54 Brake/ Clutch Bumper  
Section 320C

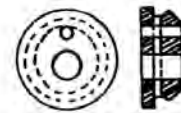

15. 3653762  
40-48 Main Wire Grommet  
Section 310C

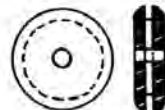

16. 3653742  
40-48 Choke Grommet  
Section 310C

Illustrations are for example and reference only. They do not indicate that we have all the parts shown.

Returns require a return authorization number—call first. • Product pricing & availability subject to change.

 **WARNING:** Cancer and Reproductive Harm — www.P65Warnings.ca.gov

**SECTION 300C  
RESTORATION PARTS**

**Floor Metal Plug**



**594289B** .....ALL  
Fits 1-1/2in. hole in floor over body mount bolts (2 pcs) 9.008 -0.3 **\$9.50 PR** ⚠

**594289C** .....ALL  
Fits 3/4in. holes in floor (2 pcs) 9.008 -0.2 ..... **\$2.00 SET** ⚠

**594289D** .....ALL  
Fits 1/2in. holes in floor (2 pcs) 9.008 -0.4 ..... **\$2.75 PR** ⚠



**594289E** .....ALL  
Fits 1-1/4in. hole (2 pcs) 9.008 -0.3 **\$7.50 PR** ⚠



**594289F** .....ALL  
Fits 1" hole (2 pcs) 9.008 -0.4 ..... **\$7.25 PR** ⚠

**Body Bolt Kit**

**BODYBOLT** .....49-50  
Stainless hardware, as original style 9.008 -0.15 ..... **\$419.75 SET** ⚠

**BODYBOLT** .....51-52  
Stainless hardware, as original style 9.008 -0.15 ..... **\$409.00 SET** ⚠

**BODYBOLT** .....53-54  
Stainless hardware, as original style 9.008 -0.15 ..... **\$399.00 SET** ⚠

**Body Mounting Bolts, Washers & Nuts**

Note: We will provide you with a complete body mount bolt set if you can provide us with accurate samples for 1937-38 Cabriolet and 1949-52 Convertible.



**3653483** .....37-39  
Body to frame, exc Cabriolet. 9.008 -0.4 ..... **\$44.00 SET** ⚠

**3653484** .....40  
Body to frame, exc Cabriolet. 9.008 -0.2 ..... **\$44.00 SET** ⚠

**3653485** .....40  
Body to frame, Cabriolet. 9.008 -0.2 ..... **\$76.00 SET** ⚠

**3785198** .....41-48  
Body to frame, Cabriolet. 9.008 -0.15 ..... **\$34.00 SET** ⚠

**3785201** .....41-48  
Body to frame, exc Cabriolet. 9.008 -0.3 ..... **\$57.00 SET** ⚠

**3785198A** .....49-52  
Body to frame, exc Convertible, Hardtop. 9.008 -0.3 ..... **\$38.00 SET** ⚠

**3688464H** .....50-52  
Body to frame, Bel Air, Hardtop. 9.008 -0.3 ..... **\$35.00 SET** ⚠

**3696977C** .....53-54  
Body to frame, Convertible. 9.008 -0.2 ..... **\$35.00 SET** ⚠

**3696978B** .....53-54  
Body to frame, exc Convertible. 9.008 -0.2 ..... **\$36.00 SET** ⚠

**Body Mount Shims**

**366982** .....ALL  
1/16in. shims (1-3/4in. x 1-1/8in. with 1/2in. slot) (6 pcs). 9.023 -0.4 ..... **\$3.50 SET** ⚠

**366983** .....ALL  
1/8in. shims (1-3/4in. x 1-1/8in. with 1/2in. slot) (6 pcs). 9.023 -0.3 ..... **\$8.25 SET** ⚠



**366984** .....ALL  
1/16in. shims (1-1/4in. x 1-1/8in. with 3/8in. slot) (6 pcs). 9.023 -0.4 ..... **\$3.75 SET** ⚠

**366985** .....ALL  
1/8in. shims (1-1/4in. x 1-1/8in. with 3/8in. slot) (6 pcs). 9.023 -0.4 ..... **\$4.00 SET** ⚠

**Body Mounting Pads**



**376904B** .....37-39  
Body to frame. 9.023 -0.25 ..... **\$46.50 SET** ⚠

**3653691C** .....40-48  
Body to frame. Cabriolet. 9.023 -0.2 ..... **\$51.50 SET** ⚠

**365369A** .....40-48  
Body to frame. Exc Cabriolet. 9.023 -0.15 ..... **\$42.50 SET** ⚠

**366981B** .....49-54  
Body to frame. Exc convertible. 9.023 -0.1 ..... **\$52.50 SET** ⚠

**366981C** .....49-54  
Body to frame. Convertible. 9.023 -0.15 ..... **\$52.50 SET** ⚠

**Caged Nuts**



**4034101** .....31-48  
Mount in body for fender bolts (4 pcs). 12.751 -0.15 ..... **\$7.00 SET** ⚠

**4034101B** .....31-48  
Mount in body for fender bolts (4 pcs). With Bolts 12.751 -0 ..... **\$12.00 SET** ⚠

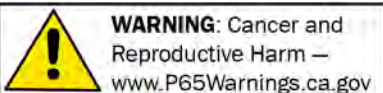

Chemicals shipped domestic ground only (Lower 48 states only). No international shipping.

**Phone: (360) 816-0211 • (800) 999-CHEV (2438) • www.chevsofthe40s.com**



**SECTION 310C  
STREET ROD PARTS**

**Firewall Pad -Polyurethane w/  
Insulation - Street Rod Firewalls**

**594350BB** ..... **37-40**  
Car, fits street rod big block firewall  
#4091695Y39. 15.280 -0.15 .....  
**\$287.00 EA** ⚠



**594350SB** ..... **37-40**  
Car, Fits street rod small block firewall  
#4091695X39. 15.280 -0.15 .....  
**\$330.00 EA** ⚠

**3658131BB** ..... **41-48**  
Car, fits street rod big block firewall  
#4117580Y48. 15.280 -0.15 .....  
**\$249.50 EA** ⚠

**3658131SB** ..... **41-48**  
Car, fits street rod small block firewall  
#4117580X48. 15.280 -0.15 .....  
**\$249.00 EA** ⚠

**Firewall Pad ABS With Insulation  
Superb**

**594350A** ..... **37-38**  
Car 15.280 -0.15 ..... **\$339.25 EA** ⚠



**350627A** ..... **39**  
Car 15.280 -0.15 ..... **\$294.50 EA** ⚠

**3658461A** ..... **40-41**

Car 15.280 -0.15 ..... **\$294.50 EA** ⚠

**3658131A** ..... **42-48**

Car 15.280 -0.15 ..... **\$339.25 EA** ⚠

**3693817A** ..... **49-50**

Car 15.280 -0.15 ..... **\$387.00 EA** ⚠

**3695693A** ..... **51-52**

Firewall Pad-ABS. W/ inside insulation.  
Super!

This item is oversized, extra shipping  
charges will apply. 15.280 -0.15 .....  
**\$387.00 EA** ⚠

**3697873A** ..... **53-54**

Car 15.280 -0.15 ..... **\$336.50 EA** ⚠

**SECTION 310C  
RESTORATION PARTS**

Note: Hood to Cowl seals see Section 250C.

**Firewall Pad w/ Insulation Fiber  
Board**



**350627** ..... **39**  
Firewall Pad with insulation and fiber  
board cover. 15.280 -0.2 .. **\$100.00 EA**  
⚠

**3685131** ..... **42-48**  
Firewall Pad with insulation and fiber  
board cover. 15.280 -0 ..... **CALL** ⚠

**3695693** ..... **49-52**  
Firewall Pad with insulation and fiber  
board cover.  
This item is oversized, extra shipping  
charges will apply. 15.280 -0 ..... **CALL** ⚠

**Metal Clips Firewall Pad**



**3692752** ..... **34-54**  
1-5/16 in. long  
(original) (3 pcs).  
15.282 -0.15 .....  
**\$11.00 SET** ⚠



**3692753** ..... **34-54**  
1-1/2 in. long (original)  
(3 pcs). 15.282 -0.15  
..... **\$10.50 SET** ⚠

**Firewall Grommets**



**3681071** ..... **32-39**  
Throttle, choke, oil,  
temp 3-7/8 in. long.  
9.775 -0.15 ..... **\$18.00 EA** ⚠



**3681096** ..... **33-36**  
Armored cable, ignition  
switch to coil. 9.775 -0.15  
..... **\$8.00 EA** ⚠



**594413** ..... **37-38**  
Wiring harness &  
speedometer cable.  
9.775 -0.15 .....  
**\$3.75 EA** ⚠



**3681096B** ..... **37-46**  
Armored cable, ignition  
switch to coil. 9.775 -0.15  
..... **\$8.50 EA** ⚠



**3653762A** ..... **39**  
Main wiring harness.  
9.775 -0.2 ..... **\$4.00 EA**  
⚠



**350278** ..... **39-48**  
Starter wire, center  
firewall. 9.775 -0 ..  
**\$4.00 EA** ⚠



**Firewall Grommets, cont.**



**3653684** ..... **39-48**  
Emergency brake rod.  
4.612 -0.15 .....  
**\$12.75 EA** ⚠



**873520A** ..... **39-48**  
Speedometer cable w/  
3 holes, use w/  
windshield washer.  
9.775 -0 ..... **\$5.25 EA**



**875520** ..... **39-48**  
Speedometer cable.  
9.775 -0.4 ..... **\$1.75 EA**  
⚠



**4111335A** ..... **40-41**  
Cabriolet top vacuum  
hose. 14.472 -0.15 ..  
**\$5.50 EA** ⚠



**1116304A** ..... **40-46**  
Rubber loop, holds  
armored ignition cable  
to choke cable.  
2.188 -0.15 .....  
**\$41.25 EA** ⚠



**3653742** ..... **40-48**  
Grommet for choke  
cable. 9.775 -0 .....  
**\$5.75 EA** ⚠



**3653762** ..... **40-48**  
Main wiring harness.  
9.775 -0.15 .....  
**\$22.00 EA** ⚠



**3653785** ..... **40-48**  
3 holes (temperature  
gauge, etc). 9.775 -0.15  
..... **\$10.25 EA** ⚠



**609864** ..... **46-48**  
Hydraulic top tubes.  
14.472 -0.15 .....  
**\$2.25 EA** ⚠



**3653742** ..... **49**  
Grommet for hood  
cable. 9.775 -0 .....  
**\$5.75 EA** ⚠



**3689044** ..... **49-50**  
4 holes. 9.775 -0 ..  
**\$17.00 EA** ⚠



**3696314** ..... **49-50**  
Fresh air vent cable.  
9.775 -0.15 .....  
**\$6.75 EA** ⚠



**4565380** ..... **49-50**  
Hydraulic top tubes.  
14.472 -0.15 .....  
**\$31.00 EA** ⚠



**Firewall Grommets, cont.**



**3681088.....49-52**  
Starter wire, center  
firewall. 9.775 -0.15  
**\$8.25 EA** ⚠️



**3691292A .....49-54**  
Heater Hose Grommet  
For 5/8 in. heater hose  
(thru firewall) 8.846 -0.15  
..... **\$6.25 PR** ⚠️



**3708180.....49-54**  
Speedometer cable &  
wiring harness.  
9.775 -0.15  
..... **\$31.00 EA** ⚠️



**3711896.....49-54**  
Vent cable in firewall  
braces. 9.775 -0.15  
**\$10.00 EA** ⚠️



**3695170.....51-54**  
Has 4 center holes  
available. 9.775 -0.15  
..... **\$3.00 EA** ⚠️



**3690820.....53-54**  
Starter wire, center  
firewall. 9.775 -0.15  
**\$8.00 EA** ⚠️

**Fuse Box Gasket**



**1998776.....49-54**  
Gasket. Fuse box  
junction block cover  
2.483 -0.3  
..... **\$10.00 EA** ⚠️

**Firewall Plug**



**117961..... 41**  
Rubber for hole, side of  
cowl (2 pcs). 9.775 -0.3  
..... **\$2.00 SET** ⚠️



**3681751C.....42-48**  
For 1/2in. hole on  
firewall, top center.  
9.775 -0 ..... **\$3.00 EA**  
⚠️



**3688835.....49-52**  
W/ membrane under  
left hood hinge.  
9.775 -0.15  
..... **\$6.75 EA** ⚠️



**4805844.....49-52**  
Rubber plug for 3/4 in.  
holes. 9.775 -0 .....  
**\$2.25 EA** ⚠️



**3681751C.....49-54**  
For 1/2in. hole, side  
cowl panel. 9.775 -0  
..... **\$3.00 EA** ⚠️

**Steering Column Foam Seal**



**594340.....37-38**  
Steering column at  
floor. 6.758 -0.15 ..  
**\$24.75 EA** ⚠️



**3653713.....40-48**  
Steering column at  
floor. 6.758 -0.3 ...  
**\$6.75 EA** ⚠️



**3691549.....49-54**  
Steering column at  
floor. 6.758 -0.4 ...  
**\$8.75 EA** ⚠️

**Steering Column Grommet At Floor**



**594344.....37-38**  
Steering column at  
floor. 6.758 -0.15  
**\$33.75 EA** ⚠️



**350617..... 39**  
Steering column at floor  
shift. 6.758 -0.15  
**\$33.75 EA** ⚠️



**3650395..... 39**  
Steering column at  
floor, column shift.  
6.758 -0.15 .....  
**\$57.75 EA** ⚠️



**3653690.....40-48**  
Steering column at  
floor, brown. 6.758 -0.4  
..... **\$13.50 EA** ⚠️



**3653690A .....40-48**  
Steering column at  
floor, black. 6.758 -0.15  
..... **\$28.75 EA** ⚠️



**3691548.....49-54**  
Steering column at  
floor. Ribbed rubber.  
6.758 -0 ..... **CALL**  
⚠️



**3691548E.....49-54**  
Steering column at  
floor. Ribbed rubber.  
MADE IN USA  
6.758 -0.15 .....  
**\$91.25 EA** ⚠️

**3691548F.....49-54**  
Steering column at floor. Ribbed rubber.  
6.758 -0 ..... **\$16.00 EA** ⚠️

**SECTION 320C  
STREET ROD PARTS**

**Insulation Pad W/ Gasket**



**597637A.....37-38**  
Die-cut for transmission floorboard cover.  
12.565 -0.15 ..... **\$12.00 EA** ⚠️

**SECTION 320C  
RESTORATION PARTS**

**Sound Deadener And Insulation Kit**

ACOUSTI-SHIELD KIT INCLUDES: FULLY ILLUSTRATED INSTRUCTIONS FOR A PAINLESS, TWO-HOUR INSTALLATION. STAGE 1: PRE-SIZED SOUND DAMPER PADS. The first stage consists of pre-trimmed, self adhesive, Sound Damper Pads. Bonded to strategically located trouble spots on the floor pan and roof of the vehicle to control body panel vibration and noise. These spots are mapped and labeled in detailed instructions which are included in the kit. STAGE 2: PRE-TRIMMED HEAT ABSORBER/BARRIER PANELS, SPRAY ADHESIVES AND SEALING TAPE. The second stage uses a high-tech absorbing, barrier material bonded to the body panels. Will deaden sound and insulate the vehicle from radiant heat penetration. Each absorber panel is cut to the correct shape and contour for your vehicle and is mapped and labeled with detailed instructions.

**12917.....37-38**  
Fits 1937-38 Cabriolet. 15.492 -0.15 .....  
**\$666.00 KIT** ⚠️

**12915.....37-39**  
Fits 1937-39 2-door Sedan. 15.492 -0.15  
..... **\$842.75 KIT** ⚠️

**12916.....37-39**  
Fits 1937-39 Coupe. 15.492 -0.15 .....  
**\$813.75 KIT** ⚠️

**12971.....37-39**  
Fits 1937-39 4-door Sedan. 15.492 -0.15  
..... **\$899.00 KIT** ⚠️

**12918.....40-41**  
Fits 1940-41 Cabriolet. 15.492 -0.15 .....  
**\$666.00 KIT** ⚠️

**12919.....40-41**  
Fits 1940-41 Coupe. (Exc 3 passenger  
coupe) 15.492 -0.15 ..... **\$813.75 KIT** ⚠️

**15890.....42-48**  
Fits 1942-48 Business Coupe. 15.492 -0.15  
..... **\$866.25 KIT** ⚠️

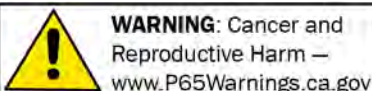

**WARNING: Cancer and Reproductive Harm** —  
www.P65Warnings.ca.gov

Chemicals shipped domestic ground only (Lower 48 states only). No international shipping.



**Phone: (360) 816-0211 • (800) 999-CHEV (2438) • www.chevsofthe40s.com**



**Sound Deadener And Insulation Kit, cont.**

- 15891..... 42-48**  
Fits 1942-48 Coupe. 15.492 -0.15 .....  
**\$935.75 KIT** ⚠
- 12920..... 49-52**  
Fits 1949-52 Styleline Sedan. 15.492 -0.15 .....  
**\$798.00 KIT** ⚠
- 12921..... 49-52**  
Fits 1949-52 Styleline Convertible.  
15.492 -0.15 ..... **\$666.00 KIT** ⚠
- 12922..... 49-52**  
Fits 1949-52 Styleline 4-door Sedan.  
15.492 -0.15 ..... **\$875.00 KIT** ⚠
- 12923..... 49-52**  
Fits 1949-52 Fleetline 2-door Sedan.  
15.492 -0.15 ..... **\$813.75 KIT** ⚠
- 12924..... 49-52**  
Fits 1949-52 Fleetline 4-door Sedan.  
15.492 -0.15 ..... **\$859.00 KIT** ⚠
- 12925..... 53-54**  
Fits 1953-54 Coupe. 15.492 -0.15 .....  
**\$933.80 KIT** ⚠
- 12926..... 53-54**  
Fits 1953-54 Sedan. 15.492 -0.15 .....  
**\$858.00 KIT** ⚠
- 15892..... 53-54**  
Fits 1953-54 Convertible. 15.492 -0.15 ..  
**\$666.00 KIT** ⚠

**Insulation**

-  **3693008A .....ALL**  
Jute w/ foil on 1 side (4 ft wide). Sold by the foot. 16.802 -0.15 .....  
**\$12.25 FT** ⚠
-  **3693008B .....ALL**  
Jute w/ foil on 2 sides (4 ft wide). Sold by the foot. 16.802 -0.15 .....  
**\$16.00 FT** ⚠
-  **3693008C .....ALL**  
Foil tape for jute insulation (30 foot x 2 in. roll). 16.802 -0.15 .....  
**\$12.00 EA** ⚠

**Jute Insulation Pad**

-  **3693008.....ALL**  
Floor mat (3 ft x 6 ft). 16.802 -0.15 .....  
**\$42.50 EA** ⚠

**Body Deadener**

-  **121126C.....ALL**  
Hi-tech, 1/2 pound per square foot (3/16 in. x 3 ft x 8 ft). 15.492 -0.15 .....  
**\$39.25 EA** ⚠

**Felt Body Deadener**

-  **121126A.....ALL**  
Original waffle pattern, used on door skins, roofs, etc (3/32in. x 3 ft x 8 ft). 15.492 -0 ..... **CALL** ⚠

**Felt Body Deadener, cont.**

-  **121126B .....ALL**  
Original waffle pattern, used on door skins, roofs, etc (1/8in. x 3 ft x 8 ft). 15.492 -0 ..... **CALL**

**Insulation Pad W/ Gasket**

-  **3652881A ..... 40**  
Trans cover, die cut. 12.565 -0.3 .....  
**\$16.00 EA** ⚠

**Floor Front Mat**



-  **4092712 .....37-39**  
W/ Fisher Emblem-black 15.286 -0 .....  
**CALL** ⚠

-  **4133494A .....41-48**  
Taupe color w/ carpet inserts & pad. 15.286 -0 ..... **CALL** ⚠

**Pedal Pads**

-  **364022.....29-36**  
Brake & clutch w/ bowtie 4.630 -0 .....  
**\$40.00 PR** ⚠
-  **593806.....37-40**  
Brake & clutch w/ bowtie 4.630 -0.15 .....  
**\$67.00 PR** ⚠
-  **3657980.....41-57**  
Brake & clutch, exc 53-54 4.630 -0.15 .....  
**\$10.75 SET** ⚠
-  **3701380.....53-54**  
Brake & clutch (2 pcs) 4.630 -0.15 .....  
**\$10.50 SET** ⚠
-  **3710955.....53-57**  
Molded for power brake. 4.630 -0.15 .....  
**\$15.00 EA** ⚠

**Brake And Clutch Pedal Bumper**

-  **594339 .....37-38**  
Brake & clutch to floor (2 pcs) 9.108 -0.15 .....  
**\$15.75 PR** ⚠
-  **3653388.....39-54**  
Brake & clutch arms to floor (2 pcs) 9.108 -0.4 .....  
**\$8.75 SET** ⚠

**Brake And Clutch Pedal Bushings**

-  **3682074.....37-54**  
Master cylinder for clutch & brake pedal shaft (trim to length for 40-54) (13/16 in. O.D. x 3/4 in. I.D. x 1-25/64 in. Long) 4.827 -0.15 .....  
**\$27.00 PR** ⚠

**Floor Felt Seals**

-  **594337 .....37-48**  
Brake & clutch pedal (2 pcs) 0.829 -0.15 .....  
**\$6.00 PR** ⚠



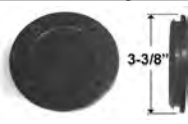

**Brake Pedal Return Spring**

-  **3698665.....40-54**  
Overall length 5-3/4in. 4.827 -0.2 .....  
**\$10.00 EA** ⚠

**Master Cylinder Plug**

-  **592865.....36-54**  
Master cylinder inspection (in floor). 3-3/8 in. diameter for 3 in. hole. 12.541 -0.15 .....  
**\$8.00 EA** ⚠

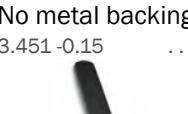
**Gas Pedal**

-  **594286 .....35-40**  
9in. x 2-1/4in. 3.451 -0.15 .....  
**\$33.00 EA** ⚠
-  **3753794.....40-48**  
W/ metal hinge, 9in. x 1-3/4in. 3.451 -0.1 .....  
**\$26.50 EA** ⚠
-  **3753794A .....40-48**  
No metal backing, just rubber cover 3.451 -0.15 .....  
**\$31.19 EA** ⚠
-  **3688127.....49-54**  
Superior quality. Comes with hinge. 3.451 -0.15 .....  
**\$17.00 EA** ⚠
-  **986325.....ALL**  
Accessory cover, heel pad w/ bowtie 3.451 -0.15 .....  
**\$26.50 EA** ⚠

**Gas Pedal Seal**

-  **378431.....35-40**  
Gas pedal rod in floor. 7/16 in. I.D. hole for rod. 2 in. O.D. mounting pad. 3.469 -0.15 .....  
**\$25.00 EA** ⚠

Returns require a return authorization number—call first. • Product pricing & availability subject to change.

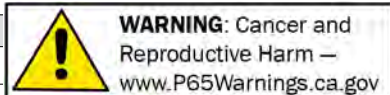

**Gas Pedal Seal, cont.**



**3658395B .....41-54**  
Felt, gas pedal rod in floor (3 pcs) 3.469 -0.2  
..... **\$5.00 SET** ⚠

**Carpet Grommets**



**4618147A.....49-57**  
Gas pedal, dimmer switch. Black rubber.  
15.286 -0.3 .....  
**\$30.00 PR** ⚠

**Starter Button Cap**



**397577 .....29-39**  
Snaps over metal starter button, black rubber 2.004 -0.15 ..  
..... **\$16.00 EA** ⚠

**Foot Starter Button**



**3654134.....38-48**  
Rubber, foot starter. 2" dia., 1-1/4" total height.  
2.012 -0.2 ..... **\$9.50 EA**  
⚠

**Starter Bellows**



**477309 .....36-37**  
36 Standard & 37 Master 2.014 -0.15  
..... **\$57.75 EA** ⚠



**597434 .....38-48**  
Rubber 2.014 -0.15  
..... **\$40.25 EA** ⚠

**Spring-Starter Pedal Return**



**3654152.....37-48**  
Return spring 2.029 -0.15  
..... **\$4.50 EA** ⚠

**Floor Shift Seal**



**594349.....37-38**  
Trans to floor, sponge.  
4.015 -0.15 ..... **\$1.00 EA**  
⚠

**Floor Shift Rubber Cap**



**594349A.....37-38**  
On floor shift tower.  
4.015 -0.15 .....  
..... **\$64.75 EA** ⚠

**Floor Shift Boot**



**3651348A .....ALL**  
Replacement-3 speed (uses #3654365T trim ring). 4.015 -0.3 .....  
..... **\$10.50 EA** ⚠

**Floor Shift Trim Ring**



**3654365T.....ALL**  
Stainless retains boot #3651348A. 4.044 -0.15  
..... **\$14.00 EA** ⚠

**Hand Brake Seal**



**549753.....37-38**  
Trans to floor, sponge  
4.612 -0.3 .. **\$5.00 EA**  
⚠

**Hand Brake Boot**



**594988A.....ALL**  
Floor hand brake (not original) uses trim plate #595026 4.612 -0.3  
..... **\$9.50 EA** ⚠

**Hand Brake Trim Plate**



**595026.....ALL**  
Stainless-retains boot #594988A 4.613 -0.15  
..... **\$12.25 EA** ⚠

**Transmission Cover Screws**



**3652879.....40-48**  
For transmission cover in floorboard (14 pcs)  
12.559 -0.15 .....

**\$4.00 SET** ⚠

**Battery Cover And Seal**



**354120.....29-36**  
Inspection cover in floor 16.547 -0.15  
..... **\$19.75 EA** ⚠



**597973A.....37-39**  
Seal for battery inspection cover in floor.  
12.541 -0.15 .....  
..... **\$43.50 EA** ⚠

**Floor Metal Plug**



**594289B .....ALL**  
Fits 1-1/2in. hole in floor over body mount bolts (2 pcs) 9.008 -0.3 ..... **\$9.50 PR** ⚠

**594289C .....ALL**  
Fits 3/4in. holes in floor (2 pcs) 9.008 -0.2 .....  
..... **\$2.00 SET** ⚠

**594289D .....ALL**  
Fits 1/2in. holes in floor (2 pcs) 9.008 -0.4 .....  
..... **\$2.75 PR** ⚠

**Floor Metal Plug, cont.**



**594289E .....ALL**  
Fits 1-1/4in. hole (2 pcs) 9.008 -0.3  
..... **\$7.50 PR** ⚠



**594289F .....ALL**  
Fits 1" hole (2 pcs) 9.008 -0.4 .....  
..... **\$7.25 PR** ⚠

**Odds And Ends**

Please call for availability on all Odds & Ends parts. Once part is sold, it may no longer be in stock.

**3653119U .....40-42**  
Clutch pedal push rod used 0.832 -0 .....  
..... **\$15.00 EA** ⚠



**WARNING:** Cancer and Reproductive Harm — www.P65Warnings.ca.gov

Chemicals shipped domestic ground only (Lower 48 states only). No international shipping.

**Phone: (360) 816-0211 • (800) 999-CHEV (2438) • www.chevsofthe40s.com**





**Dome Light Switch, cont.**

 **4598587.....49-54**  
Gasket, door jamb dome light switch  
11.951 -0.2 **\$5.00 PR**  
⚠️

**Dome Light Assembly**

 **4603601.....53-55**  
W/ Lens & Socket, Hardtop & 55 Nomad  
11.927 -0.15 .....  
**\$49.00 EA** ⚠️

**Dome Light Lens**

 **4073975.....34-40**  
With round rim. Without switch 11.928 -0.2 ..  
**\$35.00 EA** ⚠️

 **4102341.....37-52**  
Fits Convertible. Lens only 11.928 -0 ..... **CALL**  
⚠️

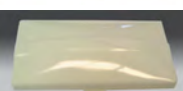
 **4091399.....40-48**  
Rectangular 11.928 -0.15 ..... **\$13.50 EA** ⚠️

 **4122196.....41-48**  
Deluxe, pointed end. 11.928 -0.2 .....  
**\$21.75 EA** ⚠️

 **4168051.....49-54**  
Except Convertible & Hardtop 11.928 -0.3  
**\$13.50 EA** ⚠️

 **4589622.....50-52**  
Bel Air & Hardtop. 11.928 -0.15 .....  
**\$13.50 EA** ⚠️

 **4577221.....53-54**  
Convertible 11.928 -0.2 ..... **\$18.00 EA** ⚠️

 **4605664.....53-55**  
Hardtop & 55 Nomad 11.928 -0.2 **\$8.00 EA**  
⚠️

**Dome Light Rim**

 **4089646.....40-48**  
Rectangular 11.928 -0.2 ..... **\$19.50 EA** ⚠️

 **4122197.....41-48**  
Deluxe, pointed end 11.928 -0.15 .....  
**\$29.50 EA** ⚠️

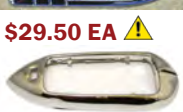
 **4168052.....49-54**  
Exc Hardtop & Convertible 11.928 -0.15 .....  
**\$33.50 EA** ⚠️

**Ash Tray Knob**

 **4091275A.....39**  
Rear armrest, rose tan. Original color and quality. 12.045 -0 ...  
**CALL** ⚠️

**604622.....40**  
Ash tray in dash, ivory. 12.018 -0.15 ....  
**\$14.00 EA** ⚠️

 **4116779A.....40-48**  
Rear armrest, ivory.† Original color and quality. 12.045 -0.4 ..  
**\$14.00 EA** ⚠️

**604622.....41-48**  
Seat back ash tray replacement, 4-door. 12.018 -0 ..... **CALL** ⚠️

**Ash Tray Rim And Lid**

 **4579370.....50-58**  
Rear armrest, complete, Hardtop and 53-58  
Convertible 12.045 -0.15 .....  
**\$34.00 EA** ⚠️

**Ash Tray Cup**

 **4579370A.....50-58**  
Receptacle, rear armrest, Hardtop and 53-58 Convertible. 12.045 -0.15 .....  
**\$13.00 EA** ⚠️

**Ash Tray Insert**

 **216541.....41-48**  
Insert for existing ash tray with two 12 volt power ports installed 12.045 -0 ... **CALL**  
⚠️

**Hat Holder**

 **985859.....41-48**  
Excellent reproduction of the original GM accessory hat holder. 8.893 -0 ... **CALL** ⚠️

**Vintage Style Flashlight**

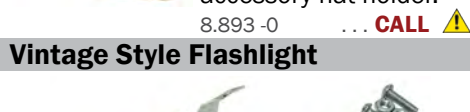
 **ACCFLASHLED.....ALL**  
Mount for ACCFLASH w/ zinc plated finish -0.15 ..... **\$9.50 EA** ⚠️

**ACCFLASHBKT.....ALL**  
Mount for ACCFLASH w/ hammertone finish -0.15 ..... **\$14.50 EA** ⚠️

**ACCFLASHBKT2.....ALL**  
Mount for ACCFLASH w/ hammertone finish -0.15 ..... **\$14.50 EA** ⚠️

**Vintage Style Flashlight, cont.**

**ACCFLASHLED.....ALL**  
Chrome flashlight has an all-metal casing, glass lens, hanging loop, adjustable beam, LED Bulb, & Morse code button., Uses 2 D cell batteries (not included) -0 .....  
**\$12.25 EA** ⚠️

**Robe Rope Escutcheon**

 **4084997.....38-48**  
Ivory for seat back. (original in 38) 11.878 -0 .....  
**\$22.00 EA** ⚠️

 **4090221.....39**  
Rose tan for seat back. 4-door 11.878 -0 ...  
**\$22.50 EA** ⚠️

**Coat Hook**

 **4601476.....39-59**  
This is a reproduction coat hook in the rear passenger compartment to hang your hangers / clothes on. 15.388 -0.15 .....  
**\$11.25 PR** ⚠️

**Odds And Ends**

Please call for availability on all Odds & Ends parts. Once part is sold, it may no longer be in stock.

**4073975UX.....34-40**  
Dome light lens. Rim only (Used) 11.928 -0.4 ..... **\$7.00 EA** ⚠️

**4089646U.....40-48**  
Rectangular dome light lens and rim. Minor pitting. Fits Master 11.928 -0.4 ....  
**\$30.00 EA** ⚠️

**4101790U.....40-52**  
Dome Light Rim (40-53 Cvt) 33.000 -0.4 .  
**\$10.00 EA** ⚠️

**4593481N.....50-52**  
Seat Adjuster Assy. Rt. Exc Cvt, Ba 14.896 -0.4 ..... **\$50.00 EA** ⚠️

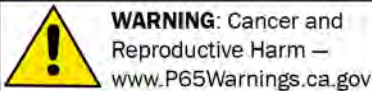

Chemicals shipped domestic ground only (Lower 48 states only). No international shipping.

Phone: (360) 816-0211 • (800) 999-CHEV (2438) • www.chevsofthe40s.com



**SECTION 335C  
STREET ROD PARTS**

**Carpet Kit**

Note: For carpet orders please specify--  
Color: black, brown, grey or maroon and Style number from firewall plate. (Example: 40-1519 = 1940 Master Deluxe Sport Sedan)

 **4582790K .....37-54**  
Front and rear cut pile carpet w/ bound edges, padding & heel pad  
15.306-0 .....starting

at **\$400.00 SET** ⚠️ **4582791K .....41-54**  
Front and rear loop carpet w/ bound edges, padding & heel pad.  
15.306-0.2 .....starting at **\$425.00 SET** ⚠️

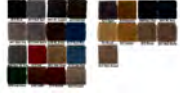
 **4612435C .....51-54**  
Sewn to fit w/ heel pad. Original 53-54 Daytona weave. 15.286-0.15  
starting at **\$593.00 SET**

**Seat Belts**

 **1001 .....ALL**  
Lap belts available in black, burgundy, grey or tan (specify color when ordering). Comes with standard pushbutton release. 52"  
14.875-0.15 ..... **\$35.00 EA** ⚠️

 **2002 .....ALL**  
2-point retractable lap only belts available in black, burgundy, grey or tan (specify color when ordering). Comes with standard pushbutton release.  
14.875-0.15 ..... **\$60.00 EA** ⚠️

 **SBELTA .....ALL**  
Aircraft style, chrome buckle lap belt. Choose color: Black, Dark Blue, Brown, Grey, Maroon, Red Wine, Red or Tan (hardware kit sold separately). 74"  
14.875-0 ..... starting at **\$22.00 EA** ⚠️

 **SBELTGM .....ALL**  
GM push button, chrome/silver buckle lap belt. Choose color: Black, Blue, Grey, or Red (hardware kit sold separately). 74"  
14.875-0 ..... starting at **\$29.00 EA** ⚠️

**Seat Belt Anchor Kit**

 **13245 .....ALL**  
Hardware anchor kit for one complete seat belt. Includes 2 of each: bolts, washers, lock washers and nuts. 14.875-0.2 .....  
**\$4.00 SET** ⚠️

**Seat Belt Anchor Kit, cont.**

 **SBHP .....ALL**  
Deluxe reinforcing anchor plates. Reduces chance of floor damage on high belt loads. Kit for 1 belt.  
14.875-0.15 ..... **\$26.00 SET** ⚠️

 **SBHPA .....ALL**  
Angled anchor mounts for flat floor applications. Use with part #SBHP to complete your seat belt installation. Kit for 1 belt.  
14.875-0.15 ..... **\$21.25 SET** ⚠️

**SECTION 335C  
RESTORATION PARTS**

**4586144 .....49-54**  
headliner clip 12.954-0.25 .. **\$5.00 EA** ⚠️  
**TOOL7672 .....ALL**  
Headliner installation tool, economy version. Used for pushing material into tight corners or channels. -0.15 .....  
**\$13.75 EA** ⚠️

**Hog Rings**  
 **HOGRING .....ALL**  
Upholstery hog rings, set of 100 pieces. -0.15 .....  
**\$2.25 SET** ⚠️

 **HOGTOOL .....ALL**  
Hog ring upholstery pliers to install seat upholstery. 14.880-0.15 .....  
**\$14.00 EA** ⚠️

**Headliners**

Oversize shipping charges apply. Please call for rate.

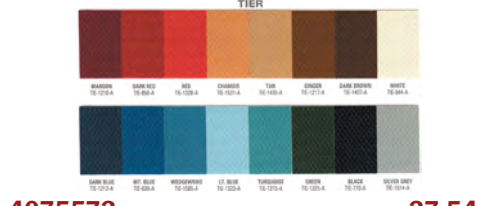

**4075573 .....37-54**  
Vinyl standard. Most colors available. Sample required. Provide style number from firewall plate. (Example: 40-1519 = 1940 Master Deluxe Sport Sedan.) (Specify year) 14.640-0.15 .....starting  
at **\$378.00 EA** ⚠️

**Headliners, cont.**

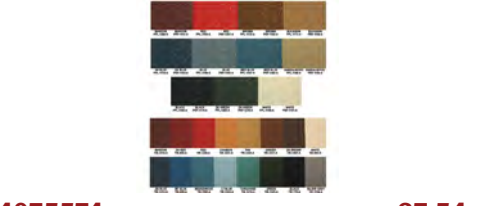

**4075574 .....37-54**  
Vinyl superior. Most colors available. Sample required. Provide style number from firewall plate. (Example: 40-1519 = 1940 Master Deluxe Sport Sedan.) (Specify year when ordering). 14.640-0  
starting at **\$250.00 EA** ⚠️



**4075572S .....37-55**  
Napped cotton fits sedan delivery & wagon. Includes visor material. Reproduction of original on most models. Specify color: Taupe, Dark Taupe, Maroon, Beige, grey, Ivory, Light Green, Dark Green, Aqua, Light Blue, Medium Blue or Black. (Specify year when ordering) 14.640-0.15  
.....starting at **\$350.00 EA** ⚠️



**4075573S .....42-55**  
Standard vinyl fits sedan delivery or wagon. Includes visor material. Reproduction of original for most models. Specify color: taupe, dark taupe, maroon, beige, grey, ivory, light, green, dark green, aqua, light blue, medium blue or black. (Specify year when ordering.) 14.640-0  
starting at **\$250.00 EA** ⚠️



**4075572 .....ALL**  
Napped cotton. Includes visor material. Reproduction of original on most models. Taupe, dark taupe, maroon, beige, grey, ivory, light green, dark green, aqua, light blue, medium blue or black. (Specify year & color) 14.640-0 .....starting at **\$355.00 EA** ⚠️

Returns require a return authorization number—call first. • Product pricing & availability subject to change.

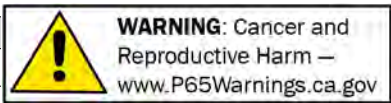

**Windlace**

Oversize shipping charges apply. Please call for rate.



**4129422A** .....**37-48**  
Windlace & wire-on trim kit for all 2-door (cloth or vinyl). Windlace goes around door openings. Wire-on hides tacks over doors to finish headlining. Specify year & color: taupe, grey, brown or black. 15.520 -0.15

..... starting at **\$153.25 SET** ⚠

**4129422C** .....**37-48**  
Windlace & wire-on trim kit for all 4-door (cloth or vinyl). Windlace goes around door openings. Wire-on hides tacks over doors to finish headlining. Specify year & color: taupe, grey, brown or black. 15.520 -0.3

..... starting at **\$304.50 SET** ⚠

**4129422S** .....**42-55**  
Windlace & wire-on trim kit for all sedan delivery (cloth or vinyl). Windlace goes around door openings. Wire-on hides tacks over doors to finish headliner. Specify year & color. 15.520 -0

..... starting at **\$146.75 KIT** ⚠

**4129422B** .....**49-54**  
Windlace for all 2-door (cloth or vinyl). Windlace goes around door openings. Specify year & color. 15.520 -0.15

..... starting at **\$93.25 EA** ⚠

**4129422D** .....**49-54**  
For all 4-door (cloth or vinyl). Windlace goes around door openings. Specify year & color: taupe, grey, brown or black. 15.520 -0.4

..... starting at **\$304.50 EA** ⚠

**Windlace Ends**



**4200980** .....**53-58**  
Hardtop & Convertible 14.735 -0.15

**\$9.00 L&R** ⚠



**4200980A** .....**53-58**  
Hardtop & Convertible on body, front and back of door. 14.735 -0

**CALL** ⚠

**Sunvisor Exterior Brackets**



**986877CS** .....**37-54**  
Exterior center windshield visor support replacement brackets. 10.201 -0.15

**\$32.00 SET** ⚠



**3699965** .....**53-54**  
Center mounting bracket for exterior sunvisor. 10.201 -0.15

..... **\$65.25 EA** ⚠

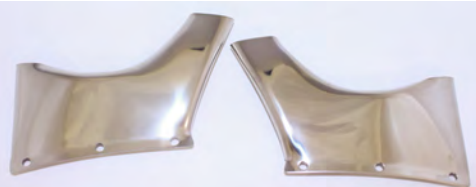

**986674A** .....**53-54**  
Side brackets steel with mounting hardware & instructions. For reproduction visors, not original. 10.201 -0.15

**\$97.75 PR** ⚠

**Sunvisor Exterior**



**986877** .....**37-48**  
Car. Exterior windshield visor. Sheetmetal, fabricated. 10.201 -0

**CALL** ⚠



**986877FS** .....**37-48**  
Car exterior visor. Metal. Repro of Fulton w/ mounting hardware & instructions. Adjustable. Fits 30s-50s Chevy, Ford Dodge and Plymouth 10.201 -0.15

**\$524.00 EA** ⚠

**Sunvisor Exterior, cont.**



**986433** .....**49-52**  
Car, steel with mounting hardware & instructions. Fleetline/ Styleline. 10.201 -0.15

..... **\$552.75 EA** ⚠

**9864331P** .....**49-52**  
Steel with mounting hardware & instructions. Fleetline/ Styleline exc Hardtop & convertible cars. Made for one piece curved windshields. 10.201 -0.15

**\$664.25 EA** ⚠



**986433H** .....**50-52**  
Bel Air Hardtops. Steel with mounting hardware & instructions. 10.201 -0.15

**\$632.00 EA** ⚠



**986674** .....**53-54**  
Car, steel with mounting hardware & instructions. (Exc. Hardtop & Wagon) 10.201 -0.15

..... **\$561.00 EA** ⚠



**986675** .....**53-54**  
Steel with mounting hardware & instructions. Non-adjustable. Fits 53-54 Hardtop. 10.201 -0.15

..... **\$573.75 EA** ⚠

335C

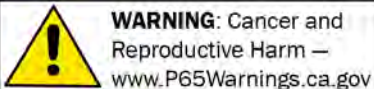

**WARNING: Cancer and Reproductive Harm** — www.P65Warnings.ca.gov

Chemicals shipped domestic ground only (Lower 48 states only). No international shipping.

**Phone: (360) 816-0211 • (800) 999-CHEV (2438) • www.chevsofthe40s.com**



**Sunvisor Assembly**



**4089225B** .....**37-40**  
Interior with brackets & end plugs. Uncovered (exc Cabriolet). 10.203 -0  
**\$125.00 L&R** ⚠

**Sunvisor**



**985574** .....**37-40**  
Center Interior Sunvisor Accessory. Light brown with darker piping. 10.203 -0  
**\$350.00 EA** ⚠  
**986877P** .....**37-53**  
Visor - Exterior Steel Peckat Reproduction Fits 30s To Early 50s With Split W/S and Drip Rails -0  
**\$750.00 EA** ⚠

**Sunvisors**

Available in Taupe, Dark Taupe, Maroon, Beige, Gray, Ivory, Light Green, Dark Green, Aqua, Red, Medium Blue or Black.

**4075532** .....**37-38**  
Napped cotton. All (exc. Cabriolet). Brackets not included. Choose color. 10.203 -0.15  
**\$180.00 L&R** ⚠

**4098730** .....**39-40**  
Napped cotton. All (exc. Cabriolet). Brackets not included. Choose color. 10.203 -0.15  
**\$180.25 L&R** ⚠

**4163244** .....**41-48**  
Napped cotton. All (exc. Cabriolet). Brackets not included. Choose color. 10.203 -0.15  
**\$226.50 L&R** ⚠



**4089625** .....**49-54**  
Presewn, ready to use. Cloth or vinyl. Call for availability. 10.203 -0.15  
**\$215.00 PR** ⚠

**4189333** .....**49-54**  
Napped cotton. Fits Belair & Hardtop. Brackets not included. Choose color. 10.203 -0.15  
**\$194.50 L&R** ⚠

**Sunvisors, cont.**

**4192016** .....**49-54**  
Napped cotton. All (exc. Conv, BelAir Hardtop & Wagon). Brackets not included. Choose color. 10.203 -0.15  
**\$165.00 L&R** ⚠

**4585915** .....**50**  
Napped cotton. All (exc. Conv, BelAir Hardtop & Wagon). Brackets not included. Choose color. 10.203 -0.15  
**\$172.00 L&R** ⚠

**4180936** .....**50-51**  
Napped cotton. Wagon only. Brackets not included. Choose color. 10.203 -0.15  
**\$180.00 L&R** ⚠

**4192256** .....**53-54**  
Napped cotton. All (exc. Conv, BelAir Hardtop & Wagon). Brackets not included. Choose color. 10.203 -0.15  
**\$170.00 L&R** ⚠

**4193268** .....**53-54**  
Napped cotton. Wagon only. Brackets not included. Choose color. 10.203 -0.15  
**\$209.75 L&R** ⚠

**Sunvisor Parts And Service**



**4074010** .....**34-54**  
Screws for interior visor bracket clamp. Exc Cabriolet & Hardtop (2 pcs) 10.224 -0.4

**\$1.25 SET** ⚠



**4034589** .....**37-38**  
Screws for interior sunvisor bracket (8 pcs) 10.225 -0.4

**\$3.25 SET** ⚠



**4074009** .....**37-40**  
Brackets for interior visor. Exc Cabriolet 10.219 -0.15

**\$121.50 L&R** ⚠



**4089225** .....**37-40**  
Interior w/ end plugs. Uncovered (exc Cabriolet). 10.203 -0.25  
**\$55.00 L&R** ⚠



**4090488A** .....**37-48**  
Bracket for interior visor (windshield frame 1/2). Fits Cabriolet. Requires 2 per visor. 10.219 -0.15  
**\$76.00 EA** ⚠



**4122402A** .....**37-48**  
Rubber plug fits end of interior sunvisor 10.203 -0.15  
**\$9.25 EA** ⚠

**Sunvisor Parts And Service, cont.**



**168593** .....**39-54**  
Screws for interior visor bracket. Exc Cabriolet, Hardtop (8 pcs) 10.225 -0.4

**\$4.50 SET** ⚠



10.219 -0.15

**4090488** .....**40-50**  
Interior visor bracket (visor 1/2 only) Fits Cabriolet & Hardtop. Requires 2 per visor.

**\$60.00 EA** ⚠



**165063** .....**40-52**  
Screws for interior visor bracket. Fits Cabriolet & Hardtop (8 pcs) 10.225 -0.4

**\$4.25 SET** ⚠

**4089625B** .....**49-54**  
Board replacement. Only available w/ sunvisor recover service. (#4089625R) 10.203 -0  
**starting at \$78.75 EA** ⚠

**Sun Shades Rear Window**



**985715E** .....**37-39**  
Rear window sun shade blinds. 11.204 -0.15  
**\$119.25 SET** ⚠

**985715** .....**40-48**  
Rear window sun shade blinds. Original accessory for 41-42 (exc. Fleetline) 11.204 -0.15  
**\$119.25 SET** ⚠

**985715FL** .....**42-48**  
Rear window sun shade blinds. Accessory for fleetline. 11.204 -0.15  
**\$119.25 SET** ⚠

**Tacking Strip**



**4112065A** .....**ALL**  
Convertible top (1/2 x 5/16) 13.384 -0.3  
**\$3.25 FT** ⚠



**4112065C** .....**ALL**  
Convertible top (5/8 x 1/8) 13.384 -0.4  
**\$3.25 FT** ⚠

**Tool**



**TOOL13575** .....**ALL**  
Headliner installation tool, -0.15  
**\$35.75 EA** ⚠



**Seat Back**



**4084737.....37-40**  
 Chrome caps holds down the windlace behind the seat (4 pcs)  
 14.821 -0.15 .....

**\$14.25 SET** ⚠️



**4125797.....39-48**  
 Black pads. Rubber, front seat back rest

11.381 -0.15

**\$27.50 PR** ⚠️



**4125797B .....39-48**  
 Brown pads. Rubber, front seat back rest

11.381 -0.15

**\$48.00 PR** ⚠️



**4591925.....49-52**  
 Chrome Knob, seat adjustment 11.588 -0  
**\$25.75 EA** ⚠️

**Upholstery Batting**



**4092635B .....37-54**  
 Cotton material placed in between upholstery and burlap. 24in. wide.  
 15.500 -0.15 . **\$2.50 FT**



**Windlace Retainer**



**4129422R .....37-38**

Stainless Steel Windlace Retainers on Front Pillar 15.520 -0.15 . **\$65.00 SET** ⚠️

**SECTION 340C RESTORATION PARTS**

**Starter Switch**



**1996037 ... 49-50**  
 Chrome button in dash. 2.100 -0.15  
 ..... **\$49.00 EA** ⚠️

**Fan**



**40848 .....ALL**  
 12 volt 6" steel blade heady duty fan. -0.15  
 ..... **\$43.25 EA** ⚠️

**Traffic Light Viewer**



**986550.....50-56**  
 Superb reproduction. 10.201 -0.15  
 ..... **\$51.50 EA** ⚠️



**986550G .....50-56**  
 "GUIDE". screw on mount. 10.201 -0.15  
 ..... **\$36.25 EA** ⚠️

**986550MB.....ALL**  
 "GUIDE" magnetic base mount.  
 10.201 -0.15 ..... **\$8.25 EA** ⚠️

**Steering Column Insulator**

**3681057A. ....37-39**  
 Steering column to dash, brown. 6.758 -0.15  
 ..... **\$26.00 EA** ⚠️

**3685524.....37-39**  
 Steering column to dash, black. 1-1/4 in. 6.758 -0.4  
 ..... **\$3.25 EA** ⚠️

**3664758.....41-48**  
 Steering column to dash. 6.764 -0.15  
 ..... **\$3.25 EA** ⚠️

**Cowl Vent Seal**

**4081958.....37-48**  
 Rubber 10.331 -0.15  
 ..... **\$24.50 EA** ⚠️

**Cowl Vent Drain Hose**



**4101941.....37-48**  
 Molded 10.344 -0.2 ..... **\$28.75 EA** ⚠️

**Cowl Vent Knob**



**985603.....39-48**  
 Ivory accessory  
 9.691 -0.25 ..... **\$15.00 EA** ⚠️

**Fresh Air Vent**



**1990701A. ....51-52**  
 Knob Original color and quality. 9.787 -0  
 ..... **CALL** ⚠️



**1990701R .....51-52**  
 Knob, cable & bracket. Good condition. Original color and quality. 9.787 -0  
 ..... **CALL** ⚠️

**Clock Knob**



**3695882.....40-48**  
 Ivory Original color and quality. 9.772 -0.4  
 ..... **\$14.00 EA** ⚠️



**3695882B .....40-48**  
 Brown. Original color and quality. 9.772 -0.4  
 ..... **\$11.00 EA** ⚠️

**Horn Knob**



**4089931C ..... 39**  
 Town & Country, rose tan. Original color and quality. 10.164 -0.4  
 ..... **\$14.00 EA** ⚠️

**Wiper Control**



**4073751.....37-38**  
 W/ link and knob  
 10.163 -0.15 ..... **\$35.00 EA** ⚠️



**4089931..... 39**  
 W/ rose tan knob, no link 10.163 -0  
 ..... **CALL** ⚠️

**Wiper Knob**



**4089931A ..... 39**  
 Rose tan. Original color and quality. 10.164 -0.15  
 ..... **\$14.00 EA** ⚠️

**Wiper And Horn Knob**



**4114285A .....40-41**  
 Ivory knob. Original color and quality.  
 10.164 -0.15 ..... **\$9.50 EA** ⚠️



**WARNING:** Cancer and Reproductive Harm — [www.P65Warnings.ca.gov](http://www.P65Warnings.ca.gov)

Chemicals shipped domestic ground only (Lower 48 states only). No international shipping.

**Phone: (360) 816-0211 • (800) 999-CHEV (2438) • www.chevsofthe40s.com**



**Wiper And Horn Knob, cont.**



**4132267.....42-48**  
Ivory knob. Original color and quality. 10.164 -0.15 ... **CALL** ⚠️



**4570976A..... 49**  
Ivory knob. Original color and quality. 10.164 -0.4 .....



**\$20.00 EA** ⚠️  
**4594185A ..... 50**  
Gray (exc accy washer) Original color and quality. 10.164 -0.4  
**\$20.00 EA** ⚠️

**Headlight Knob**



**1861895..... 36**  
Standard, black. 2.486 -0.15 .....



**\$14.00 EA** ⚠️  
**593860A..... 37**  
Black. Original color and quality. 2.486 -0.15 .....



**\$14.00 EA** ⚠️  
**597533A..... 38**  
Ivory. Original color and quality. 2.486 -0.4 ...



**\$14.00 EA** ⚠️  
**599352..... 39**  
Rose tan 2.486 -0.15 .....



**\$12.00 EA** ⚠️  
**3653818B ..... 40**  
Ivory 2.486 -0 .. **CALL** ⚠️



**3654033A ..... 40**  
Brown. Original color and quality. 2.486 -0.4 .....



**\$14.00 EA** ⚠️  
**3658534A ..... 41**  
Chrome w/ copper swirl center. 2.486 -0.15 ..



**\$14.00 EA** ⚠️  
**3664777A.....42-48**  
Ivory w/ copper swirl center. Original color and quality. 2.486 -0.4 .....



**\$10.00 EA** ⚠️  
**1990662..... 49**  
W/ shaft 2.486 -0.15 .....



**\$16.00 EA** ⚠️  
**1990662A ..... 49**  
Ivory Knob. Original color and quality. 2.486 -0.4 .....



**\$14.00 EA** ⚠️

**Headlight Knob, cont.**



**1990689..... 50**  
W/ shaft 2.486 -0.15 .....



**\$16.00 EA** ⚠️  
**1990689A ..... 50**  
Knob. Original color and quality. 2.486 -0.4 .....



**\$14.00 EA** ⚠️  
**1990696.....51-52**  
W/ shaft, ivory w/ chrome insert. 2.486 -0.15 .....



**\$20.00 EA** ⚠️  
**1990696A .....51-52**  
Ivory w/ chrome insert. Original color and quality. 2.486 -0 .....

**Choke Knob**



**47649AA..... 36**  
Standard, black. 3.521 -0.4 .....



**\$14.00 EA** ⚠️  
**593867A..... 37**  
Black. Original color and quality. 3.521 -0.15 .....



**\$14.00 EA** ⚠️  
**598181A..... 38**  
Ivory. Original color and quality. 3.521 -0 .....



**CALL** ⚠️  
**350566A..... 39**  
Rose tan. Original color and quality. 3.521 -0.4 .....



**\$14.00 EA** ⚠️  
**3654259A ..... 40**  
Brown. Original color and quality. 3.521 -0.15 .....



**\$14.00 EA** ⚠️  
**3654302A ..... 40**  
Ivory. Original color and quality. 3.521 -0 .....



**CALL** ⚠️  
**3658429A ..... 41**  
Swirl center 3.521 -0.4 .....



**\$14.00 EA** ⚠️  
**3664092A .....42-48**  
Swirl center 3.521 -0.4 .....



**\$9.50 EA** ⚠️  
**1991597A..... 49**  
Ivory. Original color and quality. 3.521 -0.4 ..

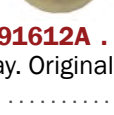

**\$14.00 EA** ⚠️  
**1991612A ..... 50**  
Gray. Original color and quality. 3.521 -0.4 .....

**\$14.00 EA** ⚠️

**Choke Knob, cont.**



**1991619A.....51-52**  
Ivory w/ chrome insert. Original color and quality. 3.521 -0 .....

**Choke Cable Assembly**



**CALL** ⚠️  
**476496..... 36**  
W/ knob. 3.521 -0.4 .....

**\$45.00 EA** ⚠️  
**593867..... 37**  
W/ knob. Original color and quality. 3.521 -0.4 .....

**\$30.00 EA** ⚠️  
**598181..... 38**  
W/ knob. Original color and quality. 3.521 -0 .....

**CALL** ⚠️  
**350566..... 39**  
W/ knob. Original color and quality. 3.521 -0.4 .....

**\$30.00 EA** ⚠️  
**3654302 ..... 40**  
W/ knob (Ivory) Original color and quality. 3.521 -0 .....

**CALL** ⚠️  
**3658529 ..... 41**  
W/ knob. Original color and quality. 3.521 -0.4 .....

**\$30.00 EA** ⚠️  
**3664775..... 42-48**  
W/ knob. 3.521 -0.15 .....

**\$19.50 EA** ⚠️  
**1991597..... 49**  
W/ knob (Ivory) Original color and quality. 3.521 -0 .....

**\$30.00 EA** ⚠️  
**1991612..... 50**  
W/ knob (Gray) Original color and quality. 3.521 -0 .....

**\$30.00 EA** ⚠️  
**1991619 ..... 51-52**  
W/ knob. Original color and quality. 3.521 -0 .....

**CALL** ⚠️  
**1991619 ..... 51-52**  
W/ knob. Original color and quality. 3.521 -0 .....

**Throttle Knob**



**476494A..... 36**  
Standard, black. 3.481 -0.15 .....



**\$14.00 EA** ⚠️  
**593862A..... 37**  
Black Original color and quality. 3.481 -0.15 .....



**\$14.00 EA** ⚠️  
**604308A..... 38**  
Ivory. Original color and quality. 3.481 -0 ..







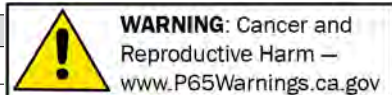

**CALL** ⚠️  
**350569A..... 39**  
Rose tan Original color and quality. 3.481 -0.4 .....



**\$14.00 EA** ⚠️



**Throttle Knob, cont.**



-  **3654269A** ..... 40  
Brown. Original color and quality. 3.481 -0.15  
..... **\$14.00 EA** ⚠
-  **3654270A** ..... 40  
Ivory 3.481 -0.4 ..  
**\$14.00 EA** ⚠
-  **3658531A** ..... 41  
Copper swirl center. 3.481 -0.4 ..  
**\$14.00 EA** ⚠
-  **3664776A**..... 42-48  
Copper swirl center. 3.481 -0.4 ..  
**\$9.50 EA** ⚠
-  **1992580A** ..... 49  
Ivory. Original color and quality. 3.521 -0.4  
**\$14.00 EA** ⚠
-  **1992592A** ..... 50  
Gray. Original color and quality. 3.521 -0.4  
**\$14.00 EA** ⚠

**Throttle Cable Assembly**





- 476494**..... 36  
W/ knob. 3.481 -0.4 ... **\$45.00 EA** ⚠
- 593862**..... 37  
W/ knob. Original color and quality. 3.481 -0.4 ..  
**\$30.00 EA** ⚠
- 604308** ..... 38  
W/ knob. Original color and quality. 3.481 -0 ..  
**CALL** ⚠
- 350569**..... 39  
W/ knob. Original color and quality. 3.481 -0.4 ..  
**\$30.00 EA** ⚠
- 3654270** ..... 40  
Original color and quality. W/ knob (Ivory) -0 ..  
**\$30.00 EA** ⚠
- 3658531** ..... 41  
W/ knob. Original color and quality. 3.481 -0.4 ..  
**\$30.00 EA** ⚠
- 3664776**..... 42-48  
W/ knob 3.481 -0.15 ... **\$19.50 EA** ⚠
- 1992580** ..... 49  
W/ Knob (Ivory) Original color and quality. 3.521 -0 ..  
**\$30.00 EA** ⚠
-  **1992592**..... 50  
W/ knob (Gray) Original color and quality. 3.521 -0 ..  
**\$30.00 EA** ⚠

**Cabriolet Top Knob**

-  **4111332**..... 40  
Cabriolet top (ivory). 14.467 -0 .. **CALL** ⚠
-  **4116581**..... 41  
Cabriolet top (copper swirl center). 14.467 -0.4 ..  
**\$14.00 EA** ⚠



**Choke And Throttle Plastic Plate**

-  **3648688**..... 41  
Ivory 10.252 -0.4 ..  
**\$33.00 PR** ⚠
-  **3664340**..... 42  
Brown 10.252 -0.4 ..  
**\$33.00 PR** ⚠
-  **3664342**..... 46-48  
Tan 10.252 -0 ..  
**CALL** ⚠







**Ignition Switch Bezel**

-  **3707716** ..... 53-54  
Plastic 2.198 -0.15 ..  
**\$31.75 EA** ⚠

**Shift or Emergency Knob**

-  **985099**..... 37  
Brown, accessory. 4.009 -0.15 ..  
**\$35.00 EA** ⚠
-  **985240**..... 38  
Ivory, accessory. 4.009 -0 ..  
**CALL** ⚠

**Shift Knob**

-  **374993** ..... 29-39  
All floor shift, black. 4.009 -0.15 ..  
**\$8.75 EA** ⚠
-  **3650273**..... 39  
Column shift, rose tan, original. 4.009 -0.15 ..  
**\$9.00 EA** ⚠
-  **3665490**..... 40-48  
Ivory, original. Original color and quality. 4.009 -0 ..  
**\$14.00 EA** ⚠
-  **3665490E** ..... 40-48  
Ivory, original. Original color and quality. 4.009 -0 ..  
**\$9.00 EA** ⚠
-  **3686800**..... 49  
Tan, original. 4.009 -0.15 ..  
**\$17.00 EA** ⚠
-  **3693923**..... 50  
Grey, original. Original color and quality. 4.009 -0.4 ..  
**\$14.00 EA** ⚠

**Shift Knob, cont.**

-  **3694310**..... 50-52  
Ivory Powerglide, original. 4.009 -0.15 ..  
**\$18.00 EA** ⚠
-  **3699416**..... 51-52  
Ivory, stick, original. Original color and quality. 4.009 -0.15 ..  
**\$14.00 EA** ⚠
-  **3718171**..... 53-54  
Black (exc Powerglide). Original. Original color and quality. 4.009 -0.4 ..  
**\$14.00 EA** ⚠

**Hood Knob**

-  **3664667A** ..... 40-49  
Script, brown. 3/16" I.D. shaft hole. 8.075 -0.4 ..  
**\$7.00 EA** ⚠

**Hood Cable Assembly**

-  **3664667**..... 40-49  
W/ knob (nut to end of housing 71" length. 74" nut to end of wire). 8.075 -0.4 ..  
**\$29.00 EA** ⚠



**Hood Choke And Throttle Cable Wire Stop**

-  **3655561**..... ALL  
Adjustable end for hood, choke, throttle cables, etc. 8.077 -0.4 ..  
**\$1.00 EA** ⚠

**Ash Tray Block Off Plate**

-  **594930**..... 37  
On dash. 12.016 -0 ..  
**CALL** ⚠

**Ash Tray Knob**

-  **4091275A**..... 39  
Rear armrest, rose tan. Original color and quality. 12.045 -0 ..  
**CALL** ⚠
-  **603350A** ..... 39  
Ash tray in dash, rose tan. Original color and quality. 12.018 -0.15 ..  
**CALL** ⚠
-  **604622**..... 40  
Ash tray in dash, ivory. 12.018 -0.15 ..  
**\$14.00 EA** ⚠

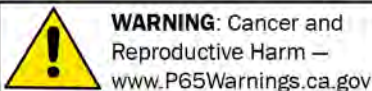

Chemicals shipped domestic ground only (Lower 48 states only). No international shipping.

**Phone: (360) 816-0211 • (800) 999-CHEV (2438) • www.chevsofthe40s.com**



**Ash Tray Knob, cont.**



**4116779A.....40-48**  
Rear armrest, ivory.†  
Original color and  
quality. 12.045 -0.4

**\$14.00 EA** ⚠

**604622.....41-48**

Seat back ash tray replacement, 4-door.

12.018 -0 ..... **CALL** ⚠

**Cigarette Lighter**



**986050J.....ALL**  
6V w/ socket &  
element, no knob.  
9.709 -0.15

**\$24.75 EA** ⚠

**Cigarette Lighter Element**



**986050A.....42-53**  
6v, fits original Casco  
(NOS). 9.709 -0

**CALL** ⚠

**Ash Tray Insert**



**216541.....41-48**  
Insert for existing ash  
tray with two 12 volt

power ports installed 12.045 -0 ..... **CALL**

⚠

**Odds And Ends**

Please call for availability on all Odds & Ends  
parts. Once part is sold, it may no longer be in  
stock.

**986876.....54**

Ashtray- Accy. Under Dash (NOS)

26.000 -0.4 ..... **\$60.00 EA** ⚠

**13760.....58-60**

Lighter knob (NOS) 9.709 -0.4 ..... **\$10.00 EA**

⚠

**13725.....ALL**

Lighter. Trico cig-lit, Automatic 26.000 -0.4

..... **\$150.00** ⚠

**SECTION 345C  
RESTORATION PARTS**

**Tissue Dispenser**



**986672.....53-55**

Superb repro, w/ bowtie. 8.891 -0.15

**\$74.25 EA** ⚠



**TISSUE.....ALL**

Box of tissue for tissue  
dispenser. 100  
sheets. -0.3

**\$5.25 EA** ⚠

**Rear View Mirror Day And Night**



**985994.....41-50**

Original 42-50 accessory. 10.185 -0

**\$50.25 EA** ⚠



**986632.....51-52**

Original accessory. 10.185 -0.15

**\$49.75 EA** ⚠



**986948.....53-59**

Original accessory. 10.185 -0.15

**\$42.00 EA** ⚠

**Rear View Mirror Interior**



**4081962.....37-38**

Interior With Bracket

Exc Cbl (Stainless)

10.185 -0.15

**\$145.00 EA** ⚠



**4101970.....39-40**

Stainless 10.185 -0.15

..... **\$100.25 EA** ⚠

**Rear View Mirror Interior, cont.**



**4116035.....41-48**

Stainless 10.185 -0.15

..... **\$100.25 EA** ⚠



**516506.....41-52**

Chrome (exc. CBL, CVT,  
HTP & SDL). Dims:

6-3/4" x 2-1/2".

10.185 -0.15

**\$32.75 EA** ⚠



**4584708.....53-54**

Stainless 10.185 -0.15

..... **\$25.50 EA** ⚠

**Vanity Mirror**

**985458.....42-48**

12v 29000.000 -0

..... **\$160.00 EA** ⚠

**985863.....42-48**

12v 29000.000 -0

..... **\$160.00 EA** ⚠



**985268.....ALL**

Complete, GM script. 10.195 -0.15

**\$38.25 EA** ⚠



**985268R.....ALL**

Complete, not original.

10.195 -0.15

**\$18.00 EA** ⚠

**Rear View Mirror Mount**



**4601549.....53-54**

Rear view mirror mount  
for htp and conv

10.185 -0.4 ..... **\$20.00 EA**

⚠

**Peep Mirror**



**985235A.....37-54**

Original 40-50, less GM  
script, left. 10.185 -0

**\$19.50 EA** ⚠



**985231A.....ALL**

Original era. 3in. round.  
Fits left or right.

10.185 -0.15

**\$23.25 EA** ⚠



**985231B.....ALL**

Original era. 4in. round.  
Fits left or right.

10.185 -0.15

**\$24.25 EA** ⚠



**Peep Mirror, cont.**



**985231BL.....ALL**  
Original era. 4in. round. Now with built in LED arrow for signal. Fits left or right. 10.185 -0.15 ..... **\$35.75 EA** ⚠



**985231E.....ALL**  
Extension for peep, moves mirror head out 1-1/2" to increase visibility and safety

10.185 -0.15 ..... **\$13.00 EA** ⚠

Visor Only. Pictured With Mirror For Reference.



**985231SS.....ALL**  
Stainless visor for 4" Peep mirrors. 10.185 -0.15 ..... **\$11.00 EA** ⚠



**9852364R.....ALL**  
4in. peep mirror GM script, right side. 29000.000 -0 ..... **\$75.00 EA** ⚠

**King Bee Mirror**



**4101972A.....37-50**  
Left side. Clamp-on. Fits Coupe & Sedan. 10.185 -0.15 ..... **\$83.50 EA** ⚠

**985777A.....37-50**  
Right side, Clamp-on. Fits Coupe & Sedan. 10.185 -0.15 ..... **\$83.50 EA** ⚠



**515848A.....37-54**  
Left side. 4-1/2in. (40-47 were originally 4in. ). Fits 49-54 Sedan Delivery, 48-50 Convertible & Hardtop. Mounting holes= 2" on center. 10.185 -0.15 ..... **\$82.75 EA** ⚠

**King Bee Mirror, cont.**



**986305A.....37-54**  
Right side. 4-1/2in. (40-47 were originally 4in. ). Fits 49-54 Sedan Delivery, 48-50 Convertible & Hardtop. 10.185 -0.15 ..... **\$86.25 EA** ⚠



**515871A.....ALL**  
Clamp for King Bee mirror. Fits Coupe & Sedan. 10.185 -0.15

**\$9.25 EA** ⚠

**Exterior Mirror**



**515848.....48-54**  
Correct reproduction, 4 1-2in. round head (flat on back side). Left side. 10.185 -0.15 ..... **\$79.00 EA** ⚠



**986305.....48-54**  
Correct reproduction, 4-1/2in. round head (flat on back side). Right side. 10.185 -0.15 ..... **\$78.00 EA** ⚠



**986762.....52-54**  
Body mount mirror w/ mounting pad and screws(original 52-53 accessory). 10.185 -0.15 ..... **\$58.25 EA** ⚠



**987460.....52-54**  
Body mount w/ mounting pad (original 55-57). 10.185 -0.15 ..... **\$34.25 EA** ⚠

**Exterior Mirror, cont.**



**987460L.....52-54**  
Body mount w/ mounting pad (original 55-57). With built in LED arrow. 10.185 -0.15 ..... **\$41.75 EA** ⚠



**985984A.....ALL**  
Curved arm, like 49-54 clamp-on. Fits left or right. 10.185 -0.15 ..... **\$21.75 EA** ⚠

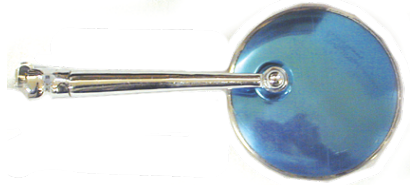

**985984D.....ALL**  
Straight arm, original era clamp-on. 10.185 -0.2 ..... **\$39.75 EA** ⚠

**Odds And Ends**

Please call for availability on all Odds & Ends parts. Once part is sold, it may no longer be in stock.

**986178.....34-50**  
Mirror-peep 4" original GM accessory (very good used) 10.185 -0.4 ..... **\$125.00 EA** ⚠

**985994NC.....37-50**  
Rear view mirror. Needs rechroming (Used) 10.185 -0 ..... **\$50.00 EA** ⚠

**516505U.....ALL**  
Rear view mirror. Painted back (Used). 10.185 -0.4 ..... **\$40.00 EA** ⚠

**516507U.....ALL**  
Day-Night rearview mirror with glare proof glass. Painted back side (Used). 10.185 -0.4 ..... **\$75.00 EA** ⚠

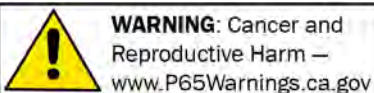

Chemicals shipped domestic ground only (Lower 48 states only). No international shipping.

**Phone: (360) 816-0211 • (800) 999-CHEV (2438) • www.chevsofthe40s.com**



**SECTION 350C  
STREET ROD PARTS**

**Dash Panel**



**ALUMDASH.....37-38**  
Billet aluminum polished - 5 gauge. Fits most gauges. Specify when ordering.. Gauges not included. 10.230 -0.15 .....  
**\$102.00 EA** ⚠



**ALUMDASHT.....37-38**  
Billet aluminum polished for three 3-3/8in gauges. Fits most gauges. Specify when ordering.. Gauges not included. 10.230 -0.15 .....  
**\$102.00 EA** ⚠



**ALUMDASH.....39**  
Billet aluminum polished - 5 gauge. Fits most gauges. Specify when ordering.. Gauges not included. 10.230 -0.15 .....  
**\$114.75 EA** ⚠



**ALUMDASHT.....39**  
Billet aluminum, polished for three 3-3/8in. gauges. Fits most gauges. Specify when ordering.. Gauges not included. 10.230 -0.15 .....  
**\$118.00 EA** ⚠

**Dash Panel, cont.**



**ALUMDASH.....40**  
Billet aluminum polished - 5 gauge. Fits most gauges. Specify when ordering.. Gauges not included. 10.230 -0.15 .....  
**\$155.50 EA** ⚠



**ALUMDASHQ.....40**  
Billet aluminum polished for two 3-3/8in gauges. Fits most gauges. Specify when ordering.. Gauges not included. 10.230 -0.15 .....  
**\$154.75 EA** ⚠

**210241.....41-48**  
Blank panel to cover up holes and to match gauge inserts 2.192 -0 ... **CALL** ⚠

**210341.....41-48**  
Under dash panel for ignition and misc. switches and power points 2.192 -0 .. **CALL** ⚠



**ALUMDASH.....41-48**  
Billet aluminum polished - 5 gauge. Fits most gauges. Specify when ordering.. Gauges not included. 10.230 -0.15 .....  
**\$164.00 EA** ⚠



**ALUMDASH5.....41-48**  
Billet aluminum polished - 5 gauge. 4 2-1/16 and 5 inch speedo. Gauges not included. 10.230 -0.15 .....  
**\$157.75 EA** ⚠

**ALUMDASHT.....41-48**  
Billet aluminum polished tach adaptor fits 3-3/8in tach. 10.230 -0.15 .....  
**\$77.00 EA** ⚠

**Dash Panel, cont.**



**ALUMDASHT5.....41-48**  
Tach adaptor for 41-48 dash. 5 inch tach. 10.230 -0.15 .....  
**\$77.00 EA** ⚠



**ALUMDASH.....49-50**  
Billet aluminum polished - 5 gauge. Fits most gauges. Specify when ordering.. Gauges not included. 10.230 -0.15 .....  
**\$127.50 EA** ⚠



**ALUMDASH.....51-52**  
Billet aluminum polished for two 3-3/8in gauges. Fits most gauges. Specify when ordering.. Gauges not included. 10.230 -0.15 .....  
**\$133.75 EA** ⚠



**ALUMDASH5.....51-52**  
Billet aluminum polished for two 5 inch gauges. Gauges not included. 10.230 -0.15 .....  
**\$168.00 EA** ⚠

**ALUMDASHC.....51-52**  
Billet aluminum polished with clock adaptor fits 2-1/16in clock, fits Classic and Dolphin instruments. 10.230 -0.15 .....  
**\$84.75 EA** ⚠

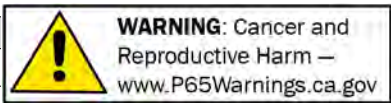

# Section 350C: Gauges, Dash Panels, Instrument Glass, Dash Parts, Glove Boxes & Voltage Reducers

## Dash Panel, cont.

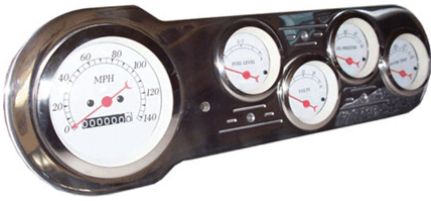

- ALUMDASH** .....53-54  
Billet aluminum polished - 5 gauge. Fits most gauges. Specify when ordering. Gauges not included. 10.230 -0.15 ..... **\$102.00 EA** ⚠
- ALUMDASH5** .....53-54  
Billet aluminum polished - 5 gauge. Fits most gauges. Specify when ordering. Gauges not included. For 5" Speedo 10.230 -0.15 ..... **\$205.75 EA** ⚠

## Dash Panel-LED Lights



- WASL18GRA1-4** ..ALL  
Choose Green, Red or Amber. 1/4" dia. Use for turn, high beam or power indicators. 12 vdc. -0.15 ..... **\$9.99 EA** ⚠
- WASL18GRA5-32** ..ALL  
Choose Green, Red or Amber. 5/32" dia. Use for turn, high beam or power indicators. 12 V. -0.15 ..... **\$6.00 EA** ⚠

## DirectFit RestoMod Gauges



- CH49T** .....49-50  
Classic Line Tan With Red Pointer Direct Fit. Includes speedometer, tachometer, fuel, temperature, volt, and oil gauges -0.15 ..... **\$996.75 EA** ⚠



- CH51AN** .....51-52  
All American Nickle With Red Pointer Direct Fit. Includes speedometer, fuel, temperature, volt, and oil gauges -0.15 ..... **\$959.50 EA** ⚠

## DirectFit RestoMod Gauges, cont.



- CH51CW** .....51-52  
Classic White With Black Pointer. Includes speedometer, fuel, temperature, volt, and oil gauges -0.15 ..... **\$806.75 EA** ⚠



- CH51HR** .....51-52  
Hot Rod Series With White Pointer Direct Fit. Includes speedometer, fuel, temperature, volt, and oil gauges -0.15 ..... **\$806.75 EA** ⚠



- CH51V8S52** .....51-52  
V8 Red Steelie Direct Fit. Includes speedometer, fuel, temperature, volt, and oil gauges -0.15 ..... **\$969.50 EA** ⚠



- CH51VT** .....51-52  
Classic line Tan With Red Pointer Direct Fit. Includes speedometer, fuel, temperature, volt, and oil gauges -0.15 ..... **\$806.75 EA** ⚠

## Voltage Reducer

- 1119004** .....ALL  
Reducer 12v to 6v. Best for fuel gauge. Hi-Tech w/ constant volts. 2.500 -0.15 ..... **\$23.50 EA** ⚠
- 1119004A** .....ALL  
12v conversion. 1 per gauge Hi-Tech w/ voltage not constant. 2.500 -0.15 ..... **\$5.25 EA** ⚠
- 1119004B** .....ALL  
Single 12v input, dual 6v outputs. 2.500 -0.15 ..... **\$40.00 EA** ⚠

## Voltage Reducer, cont.

- 1119005** .....ALL  
12v to 6v voltage reducer to operate heater, radio & gauges. Hi-tech, delivers constant volts. Superior quality. 2.500 -0.15 ..... **\$99.75 EA** ⚠
- 1119005C** .....ALL  
12v to 6v voltage reducer to operate heater. 2.500 -0.15 ..... **\$23.25 EA** ⚠
- 1506373A** .....ALL  
12v to 6v. Up to 4 amp draw affects voltage. 2.500 -0.4 ..... **\$8.50 EA** ⚠

## Voltage Booster



- 1119007** .....ALL  
6v to 12v high current booster (3.7-5.0 amps) great for: radar detectors, CB radios, mobile phones, modern stereo radios w/ CD & tape and alarm systems (control only). 2.500 -0.15 .. **\$97.00 EA** ⚠

## SECTION 350C RESTORATION PARTS

Dash Paint see Section 15C.

## Dash Plate

- 3699366** .....53-54  
Insert w/ turn signal arrows & red Bowtie. Laser cut. Stainless, satin finish. 9.744 -0.3 ..... **\$45.00 EA** ⚠
- 1500928** .....47-48  
Ammeter. Red needle. Fits all Comm & Util. 2.515 -0.15 .. **\$71.00 EA** ⚠
- 1581390** .....53-54  
Plastic Speedometer Lens Made in USA 9.748 -0 ..... **\$120.00 EA** ⚠

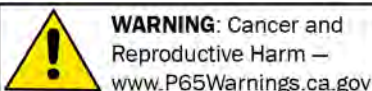

Chemicals shipped domestic ground only (Lower 48 states only). No international shipping.

Phone: (360) 816-0211 • (800) 999-CHEV (2438) • www.chevsofthe40s.com



# Section 350C: Gauges, Dash Panels, Instrument Glass, Dash Parts, Glove Boxes & Voltage Reducers

## Decal Instrument Set



**858983** ..... **34-36**  
Instrument face. Cars (exc. Standard).  
Black face. 9.748-0.15 ..... **\$15.50 EA** ⚠️



**858933** ..... **39**  
Instrument gauge. Fits late 39. Cream  
background w/ dark brown lettering  
9.748-0.3 ..... **\$26.00 EA** ⚠️



**858933A** ..... **39**  
Instrument gauge. Fits early 39. Brown  
background w/ green lettering 9.748-0  
..... **CALL** ⚠️



**1564308A** ..... **40**  
Instrument cluster w/ speedo & odometer  
9.748-0.15 ..... **\$13.00 EA** ⚠️



**1566356A** ..... **41**  
To put original gold center back in  
speedometer & clock center 9.748-0.3  
..... **\$8.00 PR** ⚠️

## Decal Instrument Set, cont.



**1566548B** ..... **42-46**  
Instrument w/ clock & odometer. 9.748-0.3  
..... **\$19.00 SET** ⚠️



**1566548C** ..... **47-48**  
Instrument w/ clock & odometer 9.748-0.2  
..... **\$22.00 EA** ⚠️

## Instrument Glass

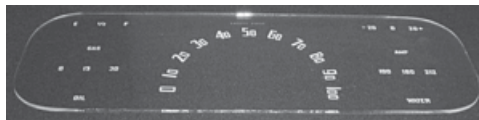

**1562830** ..... **37**  
W/ original markings. 9.748-0.15  
..... **\$29.50 EA** ⚠️



**1563997** ..... **38**  
W/ original markings. 9.748-0.15  
..... **\$39.50 EA** ⚠️



**1565308** ..... **40-46**  
With original markings (Fits 1940 Car, and  
1940-46 Truck) 9.748-0.15  
..... **\$26.00 EA** ⚠️



**1565308A** ..... **40-46**  
V8 markings w/ temp to 220 degrees & oil  
pressure at 60 psi (Fits 1940 Car, and  
1940-46 Truck). 9.748-0.15  
..... **\$20.50 EA** ⚠️

## Instrument Glass, cont.



**1566356** ..... **41**  
W/ original markings 9.748-0.15  
..... **\$27.00 EA** ⚠️



**1566548A** ..... **42-48**  
W/ original markings 9.748-0.15  
..... **\$23.00 EA** ⚠️



**1568623** ..... **49-50**  
W/ original markings, special models only  
(standard). Does not fit Deluxe models.  
9.748-0.15 ..... **\$33.75 EA** ⚠️

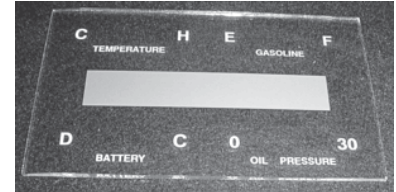

**1581308** ..... **53**  
W/ original markings. Exc Powerglide  
9.748-0.15 ..... **\$20.00 EA** ⚠️

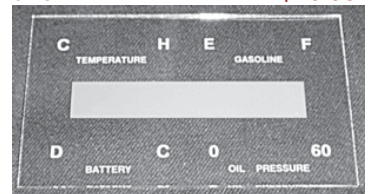

**1582543** ..... **53-54**  
53 w/ Powerglide, 54 all 9.748-0.15  
..... **\$24.75 EA** ⚠️

## Instrument Gasket



**1565309** ..... **40**  
Instrument glass to housing 9.749-0.15  
..... **\$5.75 EA** ⚠️

# Section 350C: Gauges, Dash Panels, Instrument Glass, Dash Parts, Glove Boxes & Voltage Reducers

## Speedometer Hand



**1567794.....42-48**  
Excellent quality. Red needle 9.748 -0.15  
..... **\$7.75 EA** ⚠️

## Speedometer Cable



**158829.....37-54**  
W/ original metal housing assembly. 37-48 All & 50-54 Powerglide. 70" length. 4.342 -0.15 ..... **\$18.00 EA** ⚠️  
**158829P.....37-54**  
W/ plastic housing assembly. 37-48 & 50-54 With Powerglide 4.342 -0.15 ..... **\$20.50 EA** ⚠️



**1588291A.....37-57**  
Cable without housing. 85" length (0.130 dia.). 4.342 -0.15 ..... **\$7.00 EA** ⚠️  
**1567793.....49-54**  
W/ original metal housing assembly (Exc CONV. & P.G.) 4.342 -0.15 ..... **\$59.00 EA** ⚠️

## Gauge Repair

Parts needed for repair will be in addition to servicing.

**1565912R.....ALL**  
Speedometer gauge repair service. Parts extra 9.743 -0.15 ..... **\$220.00 EA** ⚠️

## Temp Gauge Bushing



**3837160.....38-62**  
For temp gauge. 3/8" I.D. 1/2" NPT O.D. 1.150 -0.15 ..... **\$10.75 EA** ⚠️

## Oil Pressure Line



**1399637B.....37-54**  
Engine to oil gauge. 1.519 -0.2 ..... **\$26.00 EA** ⚠️

## Clock Glass



**603324.....37**  
3-15/16" x 2-1/4". 9.772 -0.15 ..... **\$28.50 EA** ⚠️



**604248.....40**  
4-1/8in. x 2-7/16in. 9.772 -0.15 ..... **\$24.75 EA** ⚠️

## Clock Hand



**986100A.....42-48**  
Red hour hand (short arm) 9.772 -0.4 ..... **\$14.00 EA** ⚠️



**986100B.....42-48**  
Red minute hand (long arm) 9.772 -0.4 ..... **\$14.00 EA** ⚠️

## Clock Knob



**3695882.....40-48**  
Ivory Original color and quality. 9.772 -0.4 ..... **\$14.00 EA** ⚠️



**3695882B.....40-48**  
Brown. Original color and quality. 9.772 -0.4 ..... **\$11.00 EA** ⚠️



**5089618A.....49-54**  
Chrome (53-54 Corvette) 9.772 -0 ..... **CALL** ⚠️

## Shift Indicator Dial



**3696730R.....50-52**  
Shift Indicator Dial Fits 50-52 Powerglide 4.038 -0 ..... **\$54.00 EA** ⚠️



**3701577R.....53-54**  
Shift Indicator Dial Fits 53-54 Powerglide 4.038 -0 ..... **\$70.00 EA** ⚠️

**3701575.....53-57**  
Shift Indicator Bezel For Powerglide and Hydramatic 4.038 -0 ..... **\$22.00 EA** ⚠️

## Washer -Dash Trim



**350054.....ALL**  
Hat shaped washer. Known uses: 41 fender top ornaments, washboards & dash

trim (16 pcs). 8.040 -0.3 .. **\$12.50 SET** ⚠️

## Chevrolet Script



**3688963.....49-50**  
On dash. 7-1/4" x 1/2". 10.252 -0.15 ..... **\$40.50 EA** ⚠️



**3702994.....53-54**  
On dash. 9-1/2" x 1/2". 10.252 -0.15 ..... **\$20.25 EA** ⚠️

## Glove Box



**4073755.....37**  
Cloth lined w/ clips 10.260 -0.15 ..... **\$24.50 EA** ⚠️



**4073755AIR.....37**  
Cars with A/C. Cloth lined w/ clips. 10.260 -0.15 ..... **\$34.75 EA** ⚠️

**4081940.....38**  
Cloth lined w/ clips 10.260 -0.15 ..... **\$24.50 EA** ⚠️



**4081940AIR.....38**  
Cars with A/C. Cloth lined w/ clips. 10.260 -0.15 ..... **\$34.75 EA** ⚠️

**4089940.....39**  
Cloth lined w/ clips 10.260 -0.15 ..... **\$24.50 EA** ⚠️



**4089940AIR.....39**  
Cars with A/C. Cloth lined w/ clips. 10.260 -0.15 ..... **\$34.75 EA** ⚠️

**4101943.....40**  
Cloth lined w/ clips 10.260 -0.15 ..... **\$26.50 EA** ⚠️

**4116124.....41-48**  
Cloth lined w/ clips 10.260 -0.15 ..... **\$26.50 EA** ⚠️

**4586673.....49-50**  
Cloth lined w/ clips 10.260 -0.15 ..... **\$26.50 EA** ⚠️

**4588363.....51-52**  
Cloth lined w/ clips 10.260 -0.15 ..... **\$26.50 EA** ⚠️

**4599945.....53-54**  
Cloth lined w/ clips 10.260 -0.15 ..... **\$26.50 EA** ⚠️

## Glove Box Screw Set



**431616.....ALL**  
To install glove box 10.261 -0.4 ..... **\$1.75 SET** ⚠️

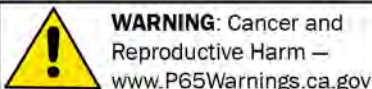

**WARNING: Cancer and Reproductive Harm** —  
www.P65Warnings.ca.gov

Chemicals shipped domestic ground only (Lower 48 states only). No international shipping.

Phone: (360) 816-0211 • (800) 999-CHEV (2438) • www.chevsofthe40s.com



# Section 350C: Gauges, Dash Panels, Instrument Glass, Dash Parts, Glove Boxes & Voltage Reducers

## Glove Box Hinge Assembly



**4086219.....37-38**  
Glove box door  
10.262 -0.15 .....  
**\$37.00 EA** ⚠

## Glove Box Bumpers



**4072911B .....37-38**  
Rubber, rectangle for  
glove box door  
11.139 -0.4 .....  
**\$0.75 SET** ⚠



**3765243.....39-52**  
Rubber, round, glove  
box door 10.263 -0.4

**\$2.00 PR** ⚠

## Glove Box Lock



**603624..... 39**  
Assembly with case and  
key (no screws) 10.266 -0  
..... **CALL** ⚠



**4566764A.....40-57**  
Gasket, glove box lock  
to door 16.110 -0.2  
**\$2.25 EA** ⚠



**4566764B .....40-57**  
Lock assembly w/ case  
& key 10.266 -0.15 ..  
**\$30.75 EA** ⚠

## Glove Box Lock Retainer



**4599106.....53-57**  
Retainer for glove box  
lock assembly  
10.267 -0.15 .....  
**\$3.75 EA** ⚠

## Glove Box Light



**985772.....37-54**  
w/ bulb. 12V. 10.275 -0.2  
..... **\$25.00 EA** ⚠

## Key Blank



**601272.....35-54**  
Original GM round  
head. Fits trunk, glove  
box & locking gas cap  
2.187 -0.2 . **\$5.25 EA**



**3694624.....35-57**  
Original GM octagon  
head. Fits ignition, door  
& spare tire locks.

2.187 -0.15

**\$3.75 EA** ⚠

## Steering Column And Dash Bottom Paint



**4115190A..... 41**  
Tan w/ pink cast.  
For dash bottom &  
steering column.  
Special Deluxe,  
quart.  
The manufacturer  
suggests a reduction  
of 8:1 to 4:1, no

hardener is necessary. 10.232 -0

**\$81.25 QT** ⚠

**4115190B..... 41**  
Tan w/ pink cast  
for dash bottom &  
steering column.  
Special Deluxe. 12  
oz spray 10.232 -0.15

**\$25.00 EA** ⚠



## Odds And Ends

Please call for availability on all Odds & Ends parts. Once part is sold, it may no longer be in stock.

**8589470 .....34-36**

Oil gauge, used 3.108 -0.4 .. **\$60.00 EA** ⚠

**1562830U .....37**

Instrument panel used (dark brown) need to be rebuilt. 9.748 -0.4 ... **\$150.00 EA** ⚠

**857848.....37-38**

Ammeter (NOS). Fits GA, HA (GB & HB on Cabriolet only) 28.000 -0.4 . **\$50.00 EA** ⚠

**1505766..... 38**

Oil pressure gauge (NOS). Fits Pass & SDN. Shelf worn 3.108 -0.4 . **\$69.00 EA** ⚠

**1500558 .....40-46**

Ammeter. Fits 40 Pass & 41-46 Truck (NOS). 2.055 -0.15 ..... **\$60.00 EA** ⚠

**1506373 .....40-46**

Oil Gauge- 40 Pass, 41-46 Truck (NOS) 28.000 -0.4 ..... **\$35.00 EA** ⚠

**1511051 ..... 41**

Temperature Gauge- (NOS) 28.000 -0.3 .. **\$150.00 EA** ⚠

**1563431 ..... 41**

Clock Spring wound 30 hours used 9.748 -0 ..... **\$75.00 EA** ⚠

**1506301U .....41-48**

Instrument cluster rear housing (Used) 9.744 -0.4 ..... **\$20.00 EA** ⚠

**156651.....42-46**

Speedometer (Used) 9.748 -0 . **\$75.00 EA** ⚠

**156651F .....42-46**

Speedometer face (Used) 9.748 -0 ..... **\$10.00 EA** ⚠

**3667672 .....42-48**

Clock cover (Used) 9.748 -0 **\$50.00 EA** ⚠

## Odds And Ends, cont.

**3684341 .....42-48**

Control trim left hand brown 10.252 -0.4 . **\$25.00 EA** ⚠

**986100.....42-48**

Clock accessory windup. Very nice condition. Needs new glass still in original box (Used) 9.772 -0 ..... **\$175.00 EA** ⚠

**1500510 .....47-48**

Ammeter- (NOS) 28.000 -0.4 ... **\$60.00 EA** ⚠

**3684127U .....47-48**

Mouldings- Dash. Below inst pnl & glove box. 26000.000 -0 ..... **\$50.00 PR** ⚠

**3847569 .....47-48**

Clock used (nice shape) 9.772 -0 ..... **\$175.00 EA** ⚠

**1506999 .....49-50**

Oil Pressure Gauge- (NOS) 28.000 -0.4 ... **\$35.00 EA** ⚠

**1501235 .....51-52**

Ammeter- (NOS) 28.000 -0.4 ... **\$60.00 EA** ⚠

**1507701..... 53**

Oil Pressure Gauge, Except Powerglide 28.000 -0.4 ..... **\$35.00 EA** ⚠

**1501349 .....53-54**

Ammeter- (NOS) 28.000 -0.4 ... **\$60.00 EA** ⚠

**4639127U .....53-54**

Glove box door. Fits wagon 10.261 -0.4 ... **\$35.00 EA** ⚠

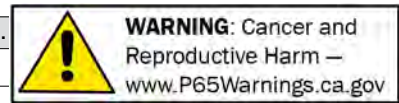

**SECTION 360C  
STREET ROD PARTS**

**Antenna Power**



**984995P** .....ALL  
Fully automatic. Fits on top of cowl or fender. 9.645 -0.15 ..... **\$82.75 EA** ⚠

**SECTION 360C  
RESTORATION PARTS**

**Voltage Booster -Radio**



**1119007** .....ALL  
6v to 12v high current booster (3.7-5.0 amps) great for: radar detectors, CB radios,

mobile phones, modern stereo radios w/ CD & tape and alarm systems (control only). 2.500 -0.15 ..... **\$97.00 EA** ⚠

**Antenna**



**984995R** .....ALL  
Cowl Top or fender top replacement. Adjustable base (swivels). 9.645 -0.2 ..... **\$19.75 EA** ⚠

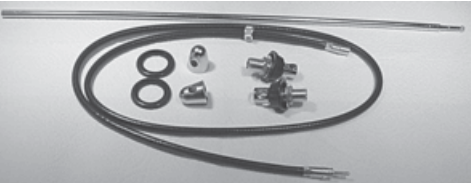

**985996R** .....ALL  
2 post side cowl mount. 9.645 -0.15 ..... **\$38.00 EA** ⚠

**Radio 1937**



**595585** ..... 37  
Radio block-off plate. 4-3/8" x 2-1/2"  
10.256 -0.15 ..... **\$73.25 EA** ⚠



**7132148** ..... 37  
Radio knob, black. Original color and quality. 9.650 -0.15 ..... **\$14.00 EA** ⚠

**Radio 1937, cont.**

**985252A** ..... 37  
Tube set, 6-tube single unit radio  
#985252. 9.650 -0.15 ..... **\$89.00 SET** ⚠  
**985253A** ..... 37  
Tube set, 6-tube header speaker radio  
#985253. 9.650 -0.15 .. **\$110.00 SET** ⚠  
**985254A** ..... 37  
Tube set, 6-tube header speaker radio  
#985254. 9.650 -0.15 .. **\$104.00 SET** ⚠



**985255A** ..... 37  
Tube set, 6-tube dash speaker radio  
#985255. 9.650 -0.15 .. **\$136.00 SET** ⚠  
**7232626** ..... 37-39  
Radio dial lens, 2in. diameter. 9.650 -0.2 ..... **\$35.50 EA** ⚠



**Radio 1938**



**7232626** ..... 37-39  
Radio dial lens, 2in. diameter. 9.650 -0.2 ..... **\$35.50 EA** ⚠



**7232768** ..... 38  
Radio knob, ivory. Original color and quality. 9.650 -0 ..... **CALL** ⚠

**985282A** ..... 38  
Tube set, 6-tube header speaker radio  
#985282. 9.650 -0.15 ..... **\$108.00 SET** ⚠  
**985283A** ..... 38  
Tube set, 7-tube dash speaker radio  
#985283. 9.650 -0.15 ..... **\$124.00 SET** ⚠  
**985284A** ..... 38  
Tube set, 7-tube dash speaker radio  
#985284. 9.650 -0.15 .. **\$176.00 SET** ⚠  
**985286A** ..... 38-39  
Tube set, 6-tube single unit radio  
#985286. 9.650 -0.15 ..... **\$108.00 SET** ⚠

**Radio 1939**



**7232626** ..... 37-39  
Radio dial lens, 2in. diameter. 9.650 -0.2 ..... **\$35.50 EA** ⚠

**985286A** ..... 38-39  
Tube set, 6-tube single unit radio  
#985286. 9.650 -0.15 ..... **\$108.00 SET** ⚠



**1212926** ..... 39  
Radio dial lens, 1 7/8in. x 1 3/8in. 9.650 -0.2 ..... **\$21.50 EA** ⚠



**1212928** ..... 39  
Pushbuttons, 7-tube twin speaker (6 pcs). 9.650 -0 ..... **CALL** ⚠

**Radio 1939, cont.**



**7232975** ..... 39  
Radio dial lens, plastic, vertical. 9.650 -0 ..... **CALL** ⚠



**7236509** ..... 39  
Radio knob, rose tan. Original color and quality. 9.650 -0 ..... **CALL** ⚠

**985424A** ..... 39  
Tube set, 7-tube twin speaker radio  
#985424. 9.650 -0.15 ..... **\$160.00 SET** ⚠  
**985425A** ..... 39  
Tube set, 5-tube single unit radio  
#985425. 9.650 -0.15 ..... **\$82.00 SET** ⚠  
**985426A** ..... 39  
Tube set, 6-tube single unit radio  
#985426. 9.650 -0.15 ..... **\$100.00 SET** ⚠



**605184** ..... 39-40  
Bakelite post pad. Original antenna. 9.645 -0.15 ..... **\$10.50 PR** ⚠

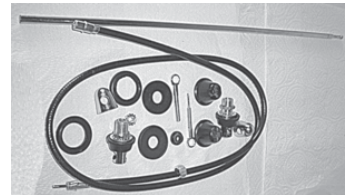

**985531** ..... 39-40  
W/ original side mount posts. Superior! 9.645 -0 ..... **CALL** ⚠



**603795** ..... 39-46  
Bakelite post base. 39-40 takes 2, 41 takes 1. 9.644 -0.3 ..... **\$24.25 EA** ⚠



**603797** ..... 39-46  
Antenna upper eye bolt for base takes 2 (1941 uses 1). 9.644 -0.2 ..... **\$21.25 EA** ⚠

**Radio 1940**



**605184** ..... 39-40  
Bakelite post pad. Original antenna. 9.645 -0.15 ..... **\$10.50 PR** ⚠

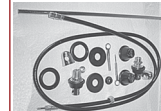

**985531** ..... 39-40  
W/ original side mount posts. Superior! 9.645 -0 ..... **CALL** ⚠



**603795** ..... 39-46  
Bakelite post base. 39-40 takes 2, 41 takes 1. 9.644 -0.3 ..... **\$24.25 EA** ⚠



**603797** ..... 39-46  
Antenna upper eye bolt for base takes 2 (1941 uses 1). 9.644 -0.2 ..... **\$21.25 EA** ⚠

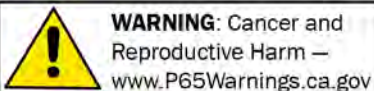

**WARNING:** Cancer and Reproductive Harm — www.P65Warnings.ca.gov

Chemicals shipped domestic ground only (Lower 48 states only). No international shipping.

**Phone: (360) 816-0211 • (800) 999-CHEV (2438) • www.chevsofthe40s.com**



**Radio 1940, cont.**



**1213966..... 40**  
Pushbuttons.  
Rectangular type. Ivory.  
9.650 -0 ..... **CALL** ⚠

**7239043..... 40**  
Radio knob, ivory.  
Original color and  
quality. 9.650 -0 ..... **CALL** ⚠

**985536A ..... 40**  
Tube set, 8-tube single unit radio  
#985536. 9.650 -0.15 ..... **\$174.00 SET** ⚠

**985537A ..... 40**  
Tube set, 6-tube single unit radio  
#985537. 9.650 -0.15 ..... **\$124.00 SET** ⚠

**985538A ..... 40**  
Tube set, 5-tube single unit radio  
#985538. 9.650 -0.15 ..... **\$102.00 SET** ⚠

**7238833..... 40-41**  
Radio dial lens, 3-1/2in.  
x 1-1/4in., plastic.  
9.650 -0 ..... **CALL** ⚠

**985651A ..... 40-41**  
Tube set, 5-tube plug in portable radio  
#985651. 9.650 -0.15 ..... **\$45.00 SET** ⚠



**985750A..... 40-48**  
Seal-radio speaker to  
dash. 9.650 -0.2 .....  
**\$12.00 EA** ⚠

**Radio 1941**



**603795..... 39-46**  
Bakelite post base.  
39-40 takes 2, 41  
takes 1. 9.644 -0.3 .....  
**\$24.25 EA** ⚠



**603797..... 39-46**  
Antenna upper eye bolt  
for base takes 2 (1941  
uses 1). 9.644 -0.2 .....  
**\$21.25 EA** ⚠

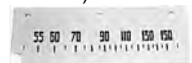

**7238833..... 40-41**  
Radio dial lens, 3-1/2in.  
x 1-1/4in., plastic.  
9.650 -0 ..... **CALL** ⚠

**985651A ..... 40-41**  
Tube set, 5-tube plug in portable radio  
#985651. 9.650 -0.15 ..... **\$45.00 SET** ⚠



**985750A..... 40-48**  
Seal-radio speaker to  
dash. 9.650 -0.2 .....  
**\$12.00 EA** ⚠



**1215125..... 41**  
Pushbuttons, 5-band w/  
shortwave, ivory.  
9.650 -0.15 .....  
**\$69.50 SET** ⚠



**604055..... 41**  
Base for Bakelite reel  
antenna. 9.650 -0.4 .....  
**\$26.25 EA** ⚠

**Radio 1941, cont.**



**604369..... 41**  
Radio knob, chrome  
with swirl center.  
9.650 -0.4 ..... **\$14.00 EA** ⚠



**605072A..... 41**  
Shaft for knob, fits  
3-button radio. 9.650 -0.15 ..... **\$10.00 EA** ⚠



**605160..... 41**  
Chrome base hex nut  
for reel antenna.  
9.650 -0.4 ..... **\$24.00 EA** ⚠



**605182..... 41**  
Upper Bakelite post  
base. Takes 1. 9.644 -0  
..... **CALL** ⚠



**605183..... 41**  
Bakelite post pads.  
Original antenna.  
9.645 -0.2 ..... **\$13.25 PR** ⚠



**605185..... 41**  
Antenna upper eye bolt  
for base. 9.644 -0.2 ..... **\$21.25 EA** ⚠



**605186..... 41**  
Screws to attach upper  
bakelight post. 9.650 -0.4  
..... **\$0.25 EA** ⚠



**7240681..... 41**  
Pushbuttons, 6-tube  
radio deluxe, ivory.  
9.650 -0.4 ..... **\$59.50 SET** ⚠

**985694A ..... 41**  
Tube set, 8-tube single unit radio  
#985694. 9.650 -0.15 ..... **\$174.00 SET** ⚠

**985695A ..... 41**  
Tube set, 6-tube single unit radio  
#985695. 9.650 -0.15 ..... **\$128.00 SET** ⚠

**985696A ..... 41**  
Tube set, 5-tube single unit radio  
#985696. 9.650 -0.15 ..... **\$134.00 SET** ⚠

**985697A ..... 41**  
Tube set, 9-tube 5-band radio #985697.  
9.650 -0.15 ..... **\$184.00 SET** ⚠

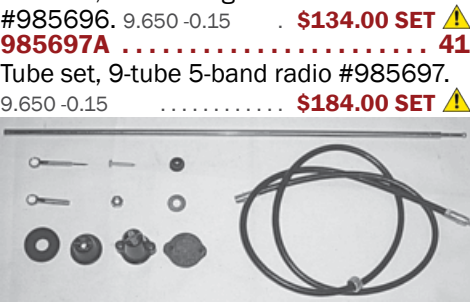

**985698..... 41**  
W/ original side mount posts & template.  
9.645 -0 ..... **CALL** ⚠



**985734KB ..... 41**  
Disc behind knobs.  
Chrome for 9 tube  
5-band short wave  
radio. 9.650 -0 ..... **CALL** ⚠

**Radio 1941, cont.**



**121537..... 41-42**  
Decal set, 5-band, goes  
on rotary dials.  
9.650 -0.15 .....  
**\$21.00 SET** ⚠



**605159..... 41-54**  
(41 reel) (2 pcs).  
9.645 -0.15 ..... **\$4.75 PR** ⚠

**Radio 1942**



**985750A..... 40-48**  
Seal-radio speaker to  
dash. 9.650 -0.2 .....  
**\$12.00 EA** ⚠

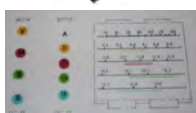

**121537..... 41-42**  
Decal set, 5-band, goes  
on rotary dials.  
9.650 -0.15 .....  
**\$21.00 SET** ⚠



**605159..... 41-54**  
(41 reel) (2 pcs).  
9.645 -0.15 ..... **\$4.75 PR** ⚠



**7242026A ..... 42**  
Brown radio  
pushbuttons (set of 5).  
9.650 -0 ..... **CALL** ⚠



**7242028 ..... 42**  
Radio face housing. Brown, 5-button,  
deluxe. 9.650 -0 ..... **CALL** ⚠

**985794A ..... 42**  
Tube set, 9-tube 5-band radio #985794.  
9.650 -0.15 ..... **\$146.00 SET** ⚠

**985792A ..... 42-46**  
Tube set, 5-tube single unit radio  
#985792. 9.650 -0.15 ..... **\$111.00 SET** ⚠

**7242247..... 42-48**  
Disk dummy (knob)  
behind front radio knob.  
Original color and  
quality. 9.650 -0.4 .....  
**\$14.00 EA** ⚠



**7242248..... 42-48**  
Disk w/ lever (knob)  
behind front radio knob.  
Original color and  
quality. 9.650 -0.4 .....  
**\$14.00 EA** ⚠



**7242249..... 42-48**  
Knob radio, ivory w/  
copper swirl center.  
9.650 -0.4 ..... **\$14.00 EA** ⚠

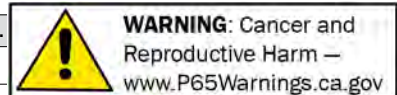

**Radio 1942**

**985793A** .....42-48  
 Tube set, 6-tube single unit radio  
 #985793. 9.650 -0.15 .. **\$147.00 SET** ⚠

**Radio 1946-48**

**985750A**.....40-48  
 Seal-radio speaker to dash. 9.650 -0.2 .....  
**\$12.00 EA** ⚠

**605159**.....41-54  
 (41 reel) (2 pcs).  
 9.645 -0.15 .. **\$4.75 PR**  
 ⚠

**985792A** .....42-46  
 Tube set, 5-tube single unit radio  
 #985792. 9.650 -0.15 .. **\$111.00 SET** ⚠

**7242247**.....42-48  
 Disk dummy (knob) behind front radio knob. Original color and quality. 9.650 -0.4 ...  
**\$14.00 EA** ⚠

**7242248**.....42-48  
 Disk w/ lever (knob) behind front radio knob. Original color and quality. 9.650 -0.4 ...  
**\$14.00 EA** ⚠

**7242249**.....42-48  
 Knob radio, ivory w/ copper swirl center. 9.650 -0.4 .. **\$14.00 EA**  
 ⚠

**985793A** .....42-48  
 Tube set, 6-tube single unit radio  
 #985793. 9.650 -0.15 .. **\$147.00 SET** ⚠

**7242026**.....46-48  
 Tan radio pushbuttons (set of 5). 9.650 -0 .....  
**CALL** ⚠

**7242329** .....46-48  
 Radio face housing, tan, 5-button, deluxe. 9.650 -0 ..... **CALL** ⚠

**985986A** .....46-48  
 Tube set, 7-tube steering column control radio #985986. 9.650 -0.15 .....  
**\$160.00 SET** ⚠

**986146A** .....47-48  
 Tube set, 5-tube single unit radio  
 #986146. 9.650 -0.15 ... **\$94.00 SET** ⚠

**Radio 1949**

**605159**.....41-54  
 (41 reel) (2 pcs).  
 9.645 -0.15 .. **\$4.75 PR**  
 ⚠

**1218731**..... 49  
 Pushbuttons for custom deluxe radio. Tan. 9.650 -0.4 **\$25.00 SET**  
 ⚠

**7257928**..... 49  
 Knob, radio, tan. 9.650 -0.4 .. **\$14.00 EA**  
 ⚠

**7257929**..... 49  
 Disk behind front radio knob (dummy disc). 9.650 -0.4 .. **\$14.00 EA**  
 ⚠

**7257930**..... 49  
 Disk w/ lever behind front radio knob. 9.650 -0.4 .. **\$14.00 EA**  
 ⚠

**986240A** ..... 49  
 Tube set, 6-tube pushbutton radio  
 #986240. 9.650 -0.15 .. **\$126.00 SET** ⚠

**986241A** ..... 49  
 Tube set, 6-tube manual radio #986241. 9.650 -0.15 ..... **\$93.00 SET** ⚠



**986652**.....49-52  
 Complete w/ template. Superb! 9.645 -0.15 ..... **\$97.00 EA** ⚠

**Radio 1950**

**605159**.....41-54  
 (41 reel) (2 pcs).  
 9.645 -0.15 .. **\$4.75 PR**  
 ⚠



**986652**.....49-52  
 Complete w/ template. Superb! 9.645 -0.15 ..... **\$97.00 EA** ⚠

**1219558**..... 50  
 Pushbuttons, custom deluxe radio, grey. 9.650 -0.4 ..... **\$114.25 SET** ⚠

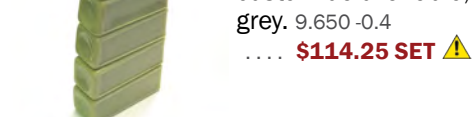

**Radio 1950, cont.**

**7258879**..... 50  
 Disk dummy (knob) behind front radio knob. Original color and quality. 9.650 -0.15 ...  
**\$14.00 EA** ⚠

**7258880**..... 50  
 Knob, radio, grey. 9.650 -0.15 **\$14.00 EA**  
 ⚠

**7258882**..... 50  
 Disk w/ lever (knob) behind front radio knob. Original color and quality. 9.650 -0.15 ...  
**\$14.00 EA** ⚠

**986388A** ..... 50  
 Tube set, 6-tube pushbutton radio  
 #986388. 9.650 -0.15 .. **\$126.00 SET** ⚠

**986389A** ..... 50  
 Tube set, 6-tube dual-unit manual radio  
 #986389. 9.650 -0.15 .. **\$120.00 SET** ⚠

**Radio 1951-52**

Original style. 2-1/2" case depth allows room for electric wipers, air conditioning, etc. Original style with FM dial in background. Two 4" x 6" quality speakers fit original front speaker opening. CD or XM (satellite) inputs. LED dial lights. AM/FM/Stereo (11.5-16.0 Volts DC). 10 station presets (5 AM, 5 FM). Maximum power =180 watts RMS (45 watts x 4 speakers 4 ohm, 14.4v, 1kHz) Sensitivity (FM S/N 30dB) typ 5dBu, (AM S/N 20dB) typ 29 dBu. 1/2" dia. shafts on controls for mounting (same size and thread as original shafts).

**605159**.....41-54  
 (41 reel) (2 pcs).  
 9.645 -0.15 .. **\$4.75 PR**  
 ⚠

**986652**.....49-52  
 Complete w/ template. Superb! 9.645 -0.15 ..... **\$97.00 EA** ⚠

**1219742**.....51-52  
 Pushbuttons for radio (set of 5). 9.650 -0.4 .. **\$25.00 SET** ⚠

**7259733**.....51-52  
 Knob for radio. Ivory w/ chrome insert. 9.650 -0.3 ..... **\$14.00 EA** ⚠



**986652**.....49-52  
 Complete w/ template. Superb! 9.645 -0.15 ..... **\$97.00 EA** ⚠

**1219742**.....51-52  
 Pushbuttons for radio (set of 5). 9.650 -0.4 .. **\$25.00 SET** ⚠

**7259733**.....51-52  
 Knob for radio. Ivory w/ chrome insert. 9.650 -0.3 ..... **\$14.00 EA** ⚠

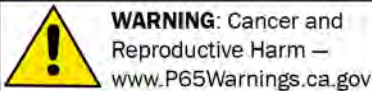
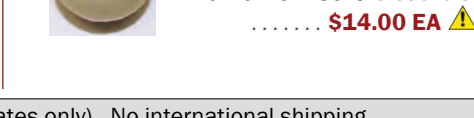

**WARNING: Cancer and Reproductive Harm** —  
[www.P65Warnings.ca.gov](http://www.P65Warnings.ca.gov)

Chemicals shipped domestic ground only (Lower 48 states only). No international shipping.

**Phone: (360) 816-0211 • (800) 999-CHEV (2438) • www.chevsofthe40s.com**



**Radio 1951-52, cont.**



**7259734.....51-52**  
Disc behind front radio knob (dummy disc). Original color and quality. 9.650 -0.15 ..

**\$24.00 EA** ⚠️



**7259738.....51-52**  
Disk w/ lever behind front radio knob. Original color and quality. 9.650 -0.15 ..

**\$14.00 EA** ⚠️

**986515A.....51-52**  
Tube set, 6-tube pushbutton radio

#986515. 9.650 -0.15 **\$126.00 SET** ⚠️

**986516A.....51-52**  
Tube set, 6-tube manual radio #986516.

9.650 -0.15 **\$120.00 SET** ⚠️

**986517R.....51-52**  
Radio, no speakers 9.650 -0.15 ..

**\$750.00 EA** ⚠️



**986517S.....51-52**  
Radio w/ speakers 9.650 -0.15 ..

**\$875.50 EA** ⚠️



**BT01.....ALL**  
Bluetooth adapter for radios with an auxiliary input. -0.15 ..

**\$40.00 EA** ⚠️

**Radio 1953-54**

Original style. 2-1/2" case depth allows room for electric wipers, air conditioning, etc.

Original style with FM dial in background.

Two 4" x 6" quality speakers fit original front speaker opening. CD or XM (satellite) inputs.

LED dial lights. AM/FM/Stereo (11.5-16.0 Volts DC). 10 station presets (5 AM, 5 FM).

Maximum power =180 watts RMS (45 watts x 4 speakers 4 ohm, 14.4v, 1kHz) Sensitivity (FM S/N 30dB) typ 5dBu, (AM S/N 20dB) typ 29 dBu. 1/2" dia. shafts on controls for mounting (same size and thread as original shafts).

Maximum power =180 watts RMS (45 watts x 4 speakers 4 ohm, 14.4v, 1kHz) Sensitivity (FM S/N 30dB) typ 5dBu, (AM S/N 20dB) typ 29 dBu. 1/2" dia. shafts on controls for mounting (same size and thread as original shafts).

Maximum power =180 watts RMS (45 watts x 4 speakers 4 ohm, 14.4v, 1kHz) Sensitivity (FM S/N 30dB) typ 5dBu, (AM S/N 20dB) typ 29 dBu. 1/2" dia. shafts on controls for mounting (same size and thread as original shafts).

Maximum power =180 watts RMS (45 watts x 4 speakers 4 ohm, 14.4v, 1kHz) Sensitivity (FM S/N 30dB) typ 5dBu, (AM S/N 20dB) typ 29 dBu. 1/2" dia. shafts on controls for mounting (same size and thread as original shafts).

Maximum power =180 watts RMS (45 watts x 4 speakers 4 ohm, 14.4v, 1kHz) Sensitivity (FM S/N 30dB) typ 5dBu, (AM S/N 20dB) typ 29 dBu. 1/2" dia. shafts on controls for mounting (same size and thread as original shafts).

Maximum power =180 watts RMS (45 watts x 4 speakers 4 ohm, 14.4v, 1kHz) Sensitivity (FM S/N 30dB) typ 5dBu, (AM S/N 20dB) typ 29 dBu. 1/2" dia. shafts on controls for mounting (same size and thread as original shafts).

Maximum power =180 watts RMS (45 watts x 4 speakers 4 ohm, 14.4v, 1kHz) Sensitivity (FM S/N 30dB) typ 5dBu, (AM S/N 20dB) typ 29 dBu. 1/2" dia. shafts on controls for mounting (same size and thread as original shafts).

Maximum power =180 watts RMS (45 watts x 4 speakers 4 ohm, 14.4v, 1kHz) Sensitivity (FM S/N 30dB) typ 5dBu, (AM S/N 20dB) typ 29 dBu. 1/2" dia. shafts on controls for mounting (same size and thread as original shafts).

Maximum power =180 watts RMS (45 watts x 4 speakers 4 ohm, 14.4v, 1kHz) Sensitivity (FM S/N 30dB) typ 5dBu, (AM S/N 20dB) typ 29 dBu. 1/2" dia. shafts on controls for mounting (same size and thread as original shafts).

Maximum power =180 watts RMS (45 watts x 4 speakers 4 ohm, 14.4v, 1kHz) Sensitivity (FM S/N 30dB) typ 5dBu, (AM S/N 20dB) typ 29 dBu. 1/2" dia. shafts on controls for mounting (same size and thread as original shafts).

Maximum power =180 watts RMS (45 watts x 4 speakers 4 ohm, 14.4v, 1kHz) Sensitivity (FM S/N 30dB) typ 5dBu, (AM S/N 20dB) typ 29 dBu. 1/2" dia. shafts on controls for mounting (same size and thread as original shafts).

Maximum power =180 watts RMS (45 watts x 4 speakers 4 ohm, 14.4v, 1kHz) Sensitivity (FM S/N 30dB) typ 5dBu, (AM S/N 20dB) typ 29 dBu. 1/2" dia. shafts on controls for mounting (same size and thread as original shafts).

Maximum power =180 watts RMS (45 watts x 4 speakers 4 ohm, 14.4v, 1kHz) Sensitivity (FM S/N 30dB) typ 5dBu, (AM S/N 20dB) typ 29 dBu. 1/2" dia. shafts on controls for mounting (same size and thread as original shafts).

Maximum power =180 watts RMS (45 watts x 4 speakers 4 ohm, 14.4v, 1kHz) Sensitivity (FM S/N 30dB) typ 5dBu, (AM S/N 20dB) typ 29 dBu. 1/2" dia. shafts on controls for mounting (same size and thread as original shafts).

Maximum power =180 watts RMS (45 watts x 4 speakers 4 ohm, 14.4v, 1kHz) Sensitivity (FM S/N 30dB) typ 5dBu, (AM S/N 20dB) typ 29 dBu. 1/2" dia. shafts on controls for mounting (same size and thread as original shafts).

Maximum power =180 watts RMS (45 watts x 4 speakers 4 ohm, 14.4v, 1kHz) Sensitivity (FM S/N 30dB) typ 5dBu, (AM S/N 20dB) typ 29 dBu. 1/2" dia. shafts on controls for mounting (same size and thread as original shafts).

Maximum power =180 watts RMS (45 watts x 4 speakers 4 ohm, 14.4v, 1kHz) Sensitivity (FM S/N 30dB) typ 5dBu, (AM S/N 20dB) typ 29 dBu. 1/2" dia. shafts on controls for mounting (same size and thread as original shafts).

Maximum power =180 watts RMS (45 watts x 4 speakers 4 ohm, 14.4v, 1kHz) Sensitivity (FM S/N 30dB) typ 5dBu, (AM S/N 20dB) typ 29 dBu. 1/2" dia. shafts on controls for mounting (same size and thread as original shafts).

**Radio 1953-54, cont.**



**7262934.....53-54**  
Radio lens w/ bowtie, pushbutton radio.

9.650 -0.15 **\$17.25 EA** ⚠️



**986627.....53-54**  
Complete w/ template. Superb! 9.645 -0.15

**986668A.....53-54**  
Tube set, 6-tube pushbutton radio

#986668. 9.650 -0.15 **\$126.00 SET** ⚠️

**986669A.....53-54**  
Tube set, 5-tube manual radio #986669.

9.650 -0.15 **\$126.00 SET** ⚠️



**986670R.....53-54**  
Radio no speakers 9.650 -0.15 ..

**\$750.00 EA** ⚠️



**986670S.....53-54**  
Radio w/ speakers 9.650 -0.15 ..

**\$875.50 EA** ⚠️



**BT01.....ALL**  
Bluetooth adapter for radios with an auxiliary input. -0.15 ..

**\$40.00 EA** ⚠️

**Radio Tube**

Note: All radio tube sets include O.Z. 4 solid state tubes (pt# 1211924).

**1211924.....37-54**  
OZ-4. Solid state (\$15 core-exchange).

9.650 -0.4 **\$50.00 EA** ⚠️

**Vibrator**



**7239124E.....37-38**  
6v w/ negative grounds. Solid state, no more radio hum (if original vibrator doesn't hum, it's time to replace it). 9.650 -0 ..

**CALL** ⚠️  
**7239124.....39-54**  
6v w/ negative grounds. Solid state, no more radio hum (if original vibrator doesn't hum, it's time to replace it). 9.650 -0.15 **\$45.00 EA** ⚠️

**7239124R.....ALL**  
12v w/ negative grounds. Solid state, no more radio hum (if original vibrator doesn't hum, it's time to replace it). 9.650 -0.15 **\$56.50 EA** ⚠️

**Radio Condenser**  
**1849161.....37-54**  
.5 MF for generator, voltage reg 9.650 -0.2 **\$5.50 EA** ⚠️



**1849161B.....37-54**  
.5 MF for generator, voltage reg 9.650 -0 **\$20.00 EA** ⚠️

**1849161C.....37-54**  
.5 MF for generator, voltage reg 9.650 -0 **\$20.00 EA** ⚠️

**7240138.....37-54**  
.5 MF for generator, voltage reg 9.650 -0 **\$22.00 EA** ⚠️

**Nut Thin Hex**  
**120369.....ALL**  
For 3/8in. Shaft-radio (2 Pc Set) 9.650 -0.4 **\$3.75 SET** ⚠️

**604275.....ALL**  
For 1/2in. Shaft-radio (2 Pc Set) 9.650 -0.4 **\$6.25 SET** ⚠️



**Radio Bracket**



**985733BKT** .....**41-42**  
 5 band radio. Black finish w/ hardware  
 9.650 -0 ..... **CALL** ⚠



**7241011** .....**41-48**  
 Back of radio. 1 piece. Mounts firewall to  
 dash. 9.650 -0 ..... **CALL** ⚠



**7241014** .....**53-54**  
 Radio mounting bracket. 9.650 -0 ..... **CALL**  
 ⚠

**Rubber Boot**



**605304A** .....**41-48**  
 Over fuse side of radio.  
 9.650 -0.15 ..... **\$22.50 EA**  
 ⚠

**Ground Strap**



**602387** .....**37-48**  
 13in. Ground strap. Engine to firewall  
 (radio). 9.650 -0.15 ..... **\$12.00 EA** ⚠



**604276** .....**37-48**  
 Ground strap. Muffler to frame (radio).  
 9.650 -0.15 ..... **\$26.75 EA** ⚠

**Odds And Ends**

Please call for availability on all Odds & Ends parts. Once part is sold, it may no longer be in stock.

- 985253** ..... **37**
- Radio, 6 Tube Directone 30.000 -0.4 .....  
**\$275.00 EA** ⚠
- 13240** ..... **39**
- Motorola Radio Face Plate Vertical  
 26.000 -0.4 ..... **\$40.00 2 PC** ⚠
- 7239124U** .....**39-54**
- Vibrator - 6 volt used. 1.664 -0.4 .....  
**\$20.00 EA** ⚠
- 605300N** .....**42-48**
- Knob. Radio (small ivory w/ swirl)  
 9.650 -0.4 ..... **\$15.00 EA** ⚠
- 3684035** .....**47-53**
- Dash moulding/ speaker grille 16.081 -0.4  
 ..... **\$35.00 EA** ⚠
- 986230U** ..... **48**
- Radio direct tone used 9.650 -0 .....  
**\$150.00 EA** ⚠
- 4672269** .....**ALL**
- Radio, GM model #467. Canadian 9.650 -0  
 ..... **\$150.00 EA** ⚠

360C



**WARNING: Cancer and Reproductive Harm** —  
 www.P65Warnings.ca.gov

Chemicals shipped domestic ground only (Lower 48 states only). No international shipping.

**Phone: (360) 816-0211 • (800) 999-CHEV (2438) • www.chevsofthe40s.com**



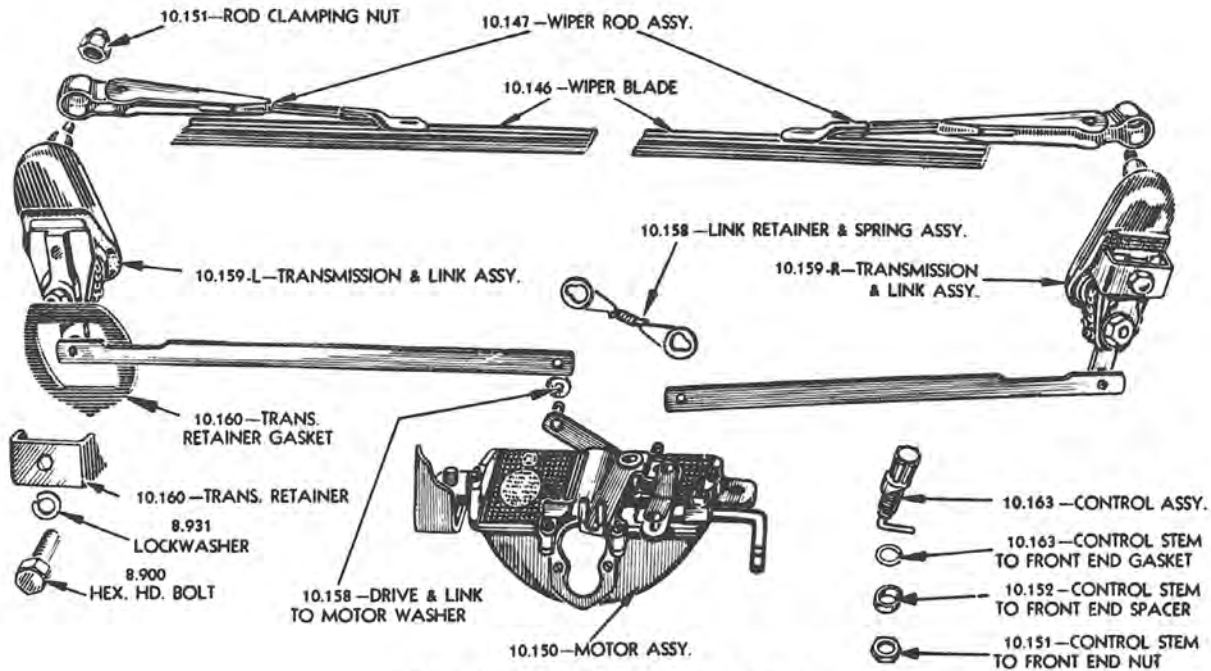

**WINDSHIELD WIPER PARTS**

**SECTION 370C  
STREET ROD PARTS**

**Voltage Booster**



**NE14206** .....**ALL**  
Voltage Booster 6 to 12 volts. Works with positive or negative ground. -0.15 .....  
**\$173.00 EA** ⚠

**Wiper Motor Electric**



**4073750N** .....**37-38**  
Chevy car 2-speed w/ park, 12v. (will not work with stock radio). 10.150 -0.15 .....  
**\$273.00 EA** ⚠  
**4089935G** .....**39**  
Chevy Car 2-speed w/ park, 12v. (will not work with stock radio). 10.150 -0.15 .....  
**\$280.00 EA** ⚠  
**4109959N** .....**40**  
Chevy Car 2-speed w/ park, 12v. (will not work with stock radio). 10.150 -0.15 .....  
**\$273.00 EA** ⚠

**Wiper Motor Electric, cont.**

**4115421N** .....**41**  
Chevy car 2-speed w/ park, 12v. (will not work with stock radio). 10.150 -0.15 .....  
**\$257.25 EA** ⚠  
**4132637N** .....**42-48**  
Chevy car 2-speed w/ park, 12v. (will not work with stock radio). 10.150 -0.15 .....  
**\$257.25 EA** ⚠  
**4614268N** .....**49-52**  
Chevy car 2-speed w/ park, 12v. (will not work with stock radio). 10.150 -0.15 .....  
**\$280.00 EA** ⚠  
**4646190N** .....**53-54**  
Chevy car 2-speed w/ park, 12v. (will not work with stock radio). 10.150 -0.15 .....  
**\$257.25 EA** ⚠  
**4646190N6** .....**53-54**  
2-speed w/ park, 6v. (will not work with stock radio). 10.150 -0.15 .. **\$264.25 EA** ⚠

**Wiper Motor With Linkage**



**4646190S** .....**53-54**  
Chevy Car 12v, 2-speed w/ park. W/ linkage (replaces old cable & spool system). 10.150 -0.15 ..... **\$517.50 EA** ⚠

**Wiper Intermittent Delay Switch**



**4073750D** .....**ALL**  
For electric wiper motors. 10.150 -0 .....  
**\$101.50 EA** ⚠

**Wiper Cap**



**BIS248810** .....**54**  
Billet Bullet cap replaces wiper arm on shaft. 11/16" or smaller shaft.  
10.159 -0.15 ..... **\$40.75 PR** ⚠  
**4601065** .....**ALL**  
Wiper chrome cap replaces wiper arm on shaft. 9/16" ID  
10.159 -0.15 .....  
**\$18.00 PR** ⚠



**4601065C** .....**ALL**  
Wiper chrome cap replaces wiper arm on shaft. Bullet cover. 9/16" ID 10.159 -0.15 .....  
**\$20.25 PR** ⚠



**BIS248815** .....**ALL**  
Billet Bullet cap replaces wiper arm on shaft. 11/16" or smaller shaft.  
10.159 -0.15 ..... **\$43.50 PR** ⚠

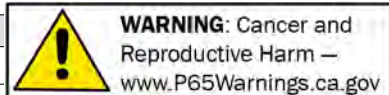

**Wiper Arm And Blade**

**603047R.....31-40**  
 7in. stainless arm w/  
 8-1/4in. blade (2 pcs).  
 10.146 -0.2 ..... **\$51.00 EA** ⚠️



**603046R.....ALL**  
 For chop top (6in. arm w/ 6in. blade).  
 10.146 -0.15 ..... **\$45.00 EA** ⚠️

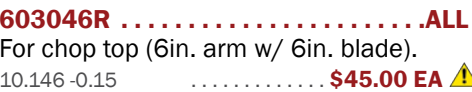

**Wiper Blade**

**NE13006.....ALL**  
 6" stainless wiper blade for use with  
 3683910A adjustable wiper arm.  
 10.146 -0.15 ..... **\$26.25 EA** ⚠️



**NE13008.....ALL**  
 8" stainless wiper blade for use with  
 3683910A adjustable wiper arm.  
 10.146 -0.4 ..... **\$26.25 EA** ⚠️

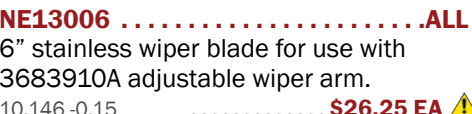

**NE13010.....ALL**  
 10" stainless wiper blade for use with  
 3683910A adjustable wiper arm.  
 10.146 -0.3 ..... **\$18.25 EA** ⚠️



**NE13012.....ALL**  
 12" stainless wiper blade for use with  
 3683910A adjustable wiper arm.  
 10.146 -0.3 ..... **\$13.25 EA** ⚠️

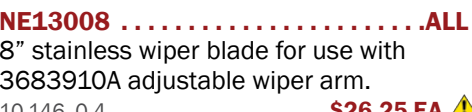

**NE13010.....ALL**  
 10" stainless wiper blade for use with  
 3683910A adjustable wiper arm.  
 10.146 -0.3 ..... **\$18.25 EA** ⚠️



**NE13010.....ALL**  
 10" stainless wiper blade for use with  
 3683910A adjustable wiper arm.  
 10.146 -0.3 ..... **\$18.25 EA** ⚠️



**NE13012.....ALL**  
 12" stainless wiper blade for use with  
 3683910A adjustable wiper arm.  
 10.146 -0.3 ..... **\$13.25 EA** ⚠️



**Wiper Arm**

**3683910A.....ALL**  
 Chrome. Adjustable length and wiper  
 angle, 6-11". Fits wiper transmissions with  
 a 9/16" spline shaft. Use with blades  
 NE130... 10.146 -0 ..... **CALL** ⚠️

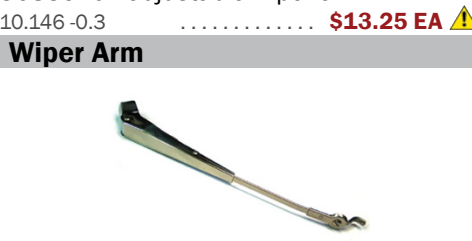

**Wiper Arm, cont.**

**3683910SA.....ALL**  
 Stainless. Adjustable length and wiper  
 angle. 6-11" Use with blades NE130...  
 10.146 -0.15 ..... **\$27.50 EA** ⚠️

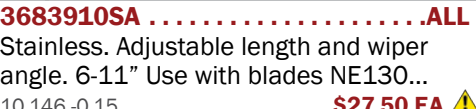

**SECTION 370C  
 RESTORATION PARTS**

**Fuel Pump**

**5591457....37-51**  
 W/ vacuum pump  
 (glass bowl) stops  
 slow wipers, original  
 accessory. Also  
 fits GMC, includes  
 gasket. 3.900 -0.15  
 ..... **CALL** ⚠️



**5591457M..37-51**  
 W/ vacuum pump  
 (metal bowl)  
 includes gasket.  
 3.900 -0  
 ..... **CALL** ⚠️

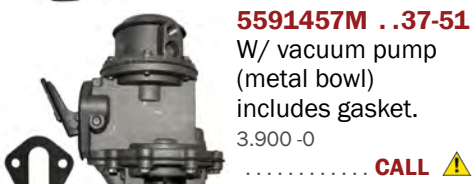

**5592675....52-57**  
 W/ vacuum pump  
 (glass bowl) stops  
 slow wipers, original  
 accessory. 3.900 -0.15  
 ..... **CALL** ⚠️

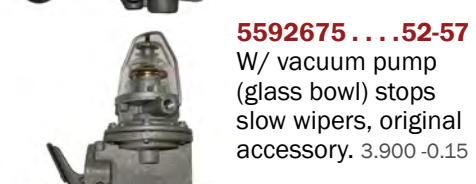

**5592675M..52-57**  
 W/ vacuum pump  
 (metal bowl) stops  
 slow wipers, original  
 accessory. 3.900 -0  
 ..... **CALL** ⚠️



**5592675M..52-57**  
 W/ vacuum pump  
 (metal bowl) stops  
 slow wipers, original  
 accessory. 3.900 -0  
 ..... **CALL** ⚠️



**Fuel Pump Rebuild Kit**



**5591844.....37-51**  
 W/ vacuum pump 3.901 -0.15 .....  
**\$89.00 EA** ⚠️

**5591825.....52-57**  
 W/ vacuum pump 3.900 -0 .. **\$77.25 EA**  
 ⚠️

**Wiper Motor Vacuum Rebuild Service**

\$15 shipping & handling for rebuild service.  
**REBUILD.....ALL**  
 Rebuild yours. Please send motor only, do  
 not send any other parts.  
 "TRICO" only! 10.150 -0.15 .....  
**\$176.00 EA** ⚠️

**Wiper Motor Gasket**

**4630475.....53-57**  
 Wiper motor to firewall  
 10.152 -0.2 .....  
**\$8.50 SET** ⚠️

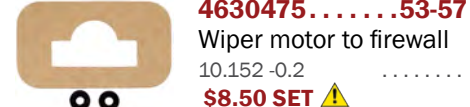

**Wiper Control**

**4073751.....37-38**  
 W/ link and knob  
 10.163 -0.15 .....  
**\$35.00 EA** ⚠️

**4089931.....39**  
 W/ rose tan knob, no  
 link 10.163 -0 ..... **CALL**  
 ⚠️

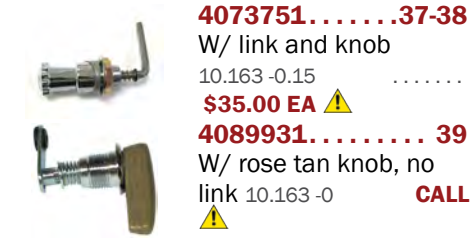

**Wiper Knob**

**4089931A.....39**  
 Rose tan. Original color  
 and quality. 10.164 -0.15  
 ..... **\$14.00 EA** ⚠️

**4114285A.....40-41**  
 Ivory knob. Original  
 color and quality.  
 10.164 -0.15 .....  
**\$9.50 EA** ⚠️

**4132267.....42-48**  
 Ivory knob. Original  
 color and quality.  
 10.164 -0.15 .. **CALL**  
 ⚠️

**4570976A.....49**  
 Ivory knob. Original  
 color and quality.  
 10.164 -0.4 .....  
**\$20.00 EA** ⚠️

**4594185A.....50**  
 Gray (exc accy washer)  
 Original color and  
 quality. 10.164 -0.4  
**\$20.00 EA** ⚠️



**Wiper Control Link Grommet**

**4093398.....39-41**  
 This is the rubber  
 grommet for the wiper  
 control link.  
 (on top of the motor below handle)  
 10.165 -0.3 ..... **\$4.25 PR** ⚠️



**Wiper Motor Bushings Pivot Linkage**

**3746483.....46-52**  
 Rubber wiper motor  
 10.158 -0.3 .....  
**\$3.00 PR** ⚠️

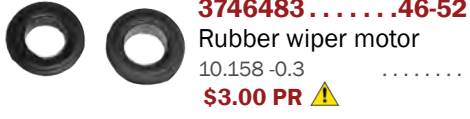
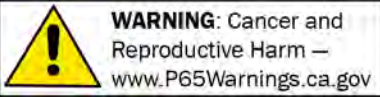

**Wiper Motor Pivot Linkage Retainer**



**4065091** ..... **36-48**  
Wiper motor retainer, Length 2-3/16".  
10.158-0.15 ..... **\$3.00 EA** ⚠



**4570135** ..... **49-52**  
Wiper motor retainer, 2-3/4" length.  
10.158-0.2 ..... **\$5.00 EA** ⚠

**Nut**



**1295056** ..... **37-40**  
Chrome acorn, retains wiper arm 10.148-0.3  
..... **\$8.00 EA** ⚠



**4601061** ..... **53-58**  
Chrome, wiper transmission to cowl 10.160-0.2 .....  
**\$4.75 EA** ⚠

**Tool**



**4601061T** ..... **53-58**  
Removes chrome wiper transmission nut 10.160-0.15 ..... **\$15.50 EA** ⚠

**Wiper Transmission**



**4073724** ..... **37**  
Includes Acorn nuts. Does not include gaskets, brackets or bolts. 10.159-0.15  
..... **\$285.00 L&R** ⚠

**4081915** ..... **38**  
Complete set 10.159-0.15 .....  
**\$285.00 L&R** ⚠

**4089606** ..... **39-40**  
Original for 1939. For 1940 use your link to motor, w/ acorn nuts 10.159-0 .....  
**\$285.00 L&R** ⚠

**4132645** ..... **41-48**  
1941 requires original 1941 linkage. 10.159-0.3 ..... **\$250.00 L&R** ⚠

**Wiper Transmission Retainer U Bracket**



**4073726** ..... **37**  
Wiper transmission 10.159-0.15 .....  
**\$23.00 PR** ⚠



**4081917** ..... **38-39**  
Wiper transmission 10.159-0.15 .....  
**\$23.00 PR** ⚠

**Wiper Transmission Gasket**



**407327** ..... **37**  
Wiper transmission to cowl 10.160-0.2 .....  
**\$8.50 PR** ⚠



**408918** ..... **38-39**  
Wiper transmission to cowl 10.160-0.2 .....  
**\$17.00 PR** ⚠

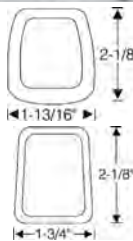

**4101962** ..... **40**  
Wiper transmission to cowl 10.160-0.2 .....  
**\$8.50 PR** ⚠

**4116798** ..... **41-48**  
Wiper transmission to cowl 10.160-0.2 .....  
**\$8.50 PR** ⚠



**4562197** ..... **49-52**  
Wiper transmission to cowl 10.160-0.2 .....  
**\$8.50 PR** ⚠



**4597009** ..... **53-54**  
Wiper transmission to cowl 10.160-0.2 .....  
**\$8.50 PR** ⚠

**Wiper Blade**



**985459** ..... **29-38**  
8-1/2in. 10.146-0.15 ..... **\$5.00 EA** ⚠

**Wiper Blade, cont.**



**985982** ..... **39-48**  
9in. 10.146-0.2 ..... **\$6.25 EA** ⚠



**3683905S** ..... **49-54**  
10in. (exc Hardtop & Convertible). 10.146-0 .....  
**\$11.00 EA** ⚠



**561094S** ..... **49-54**  
12 in. Fits Hardtop & Convertible. 10.146-0.15 .....  
**\$19.00 EA** ⚠

**Wiper Arm**



**603047** ..... **31-40**  
7in. stainless arm. 10.147-0.15 .....  
**\$24.50 EA** ⚠

**609562P** ..... **41-48**  
8in. stainless arm. 10.147-0.15 .....  
**\$15.50 EA** ⚠



**3683903BL** ..... **49-54**  
Stainless. Left side (exc sedan delivery, hardtop & convertible). 10.147-0.15 .....  
**\$17.00 EA** ⚠



**3683903BR** ..... **49-54**  
Stainless. Right side (exc sedan delivery, hardtop & convertible). 10.147-0.15 .....  
**\$17.00 EA** ⚠

**Wiper And Washer Hose Connector 3 way**

**3682929** ..... **ALL**  
Y wiper & washer, 7/32in. 16.066-0.2 .....  
**\$0.50 EA** ⚠

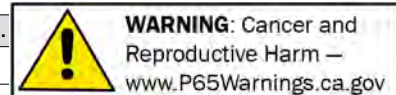

**Wiper Vacuum Hose**



**60158548.....42-48**  
Wiper control 3/16in.  
i.d. (sold in 2 ft length).  
10.155 -0.4 .....

**\$6.00 EA** ⚠



**601607.....ALL**  
Wiper motor to engine,  
1/4 in. I.D. 10.155 -0.3  
..... **\$1.50 FT** ⚠

**Windshield Washer Nozzles**



**604354.....37-48**  
WINDSHIELD WASHER  
NOZZLES Chrome w/  
mounting bracket.  
8.798 -0 . **CALL** ⚠



**3699025.....ALL**  
Screws into wiper  
transmission.  
Replacement for  
 housings with washer

tube. Chrome (does NOT fit above).  
8.798 -0.15 ..... **\$7.75 SET** ⚠

**Windshield Washer Hose**



**604041B.....37-50**  
9 ft, w/ original GM  
instruction sheet &  
firewall grommet.  
8.962 -0.3 .....

**\$30.75 KIT** ⚠

**Washer Coordinator**



**986984..... 54**  
Windshield wiper  
washer coordinator  
w/ instructions  
(NOS) 8.798 -0.4  
..... **\$150.00 EA** ⚠

**Odds And Ends**

Please call for availability on all Odds & Ends parts. Once part is sold, it may no longer be in stock.

**4089935U..... 39**  
Wiper motor vacuum used 10.150 -0 .....

**\$70.00 EA** ⚠

**4101961H..... 40**

Wiper trans housing (no link) left hand  
used 10.159 -0 ..... **\$10.00 EA** ⚠

**4114813H..... 41**

Wiper trans housing (no link) - right hand  
(Used) 10.159 -0 ..... **\$10.00 EA** ⚠

**4132644H.....42-46**

Wiper transmission housing only (no link)  
right hand used 10.159 -0 .. **\$10.00 EA** ⚠



**WARNING:** Cancer and  
Reproductive Harm –  
www.P65Warnings.ca.gov

Chemicals shipped domestic ground only (Lower 48 states only). No international shipping.

**Phone: (360) 816-0211 • (800) 999-CHEV (2438) • www.chevsofthe40s.com**



**1722**

**Parkerized**  
 Back door weatherstrip fastener short:  
**Chevrolet '41-'50 Panel Delivery**  
 Door header and pillar weatherstrip fastener short:  
**Chevrolet '37-'38**  
**All General Motors Cars '37-'38**

10.694  
 42-48 Substitute  
 Hinge Pillar  
 Weatherstrip



10.694  
 42-48 Moulded  
 Hinge Pillar  
 Weatherstrip



10.694  
 41 Lower Front  
 Corner Weatherstrip

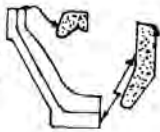

10.694 35-39  
 Door bottom  
 weatherstrip



10.695 35-39  
 Clip door bottom  
 weatherstrip

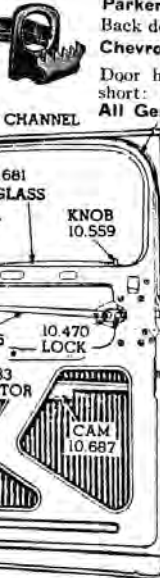

10.694 37-39  
 Top and side  
 weatherstrip



10.694 40-48  
 Top and side  
 weatherstrip



10.694  
 40-48  
 Lower  
 corner  
 weatherstrip

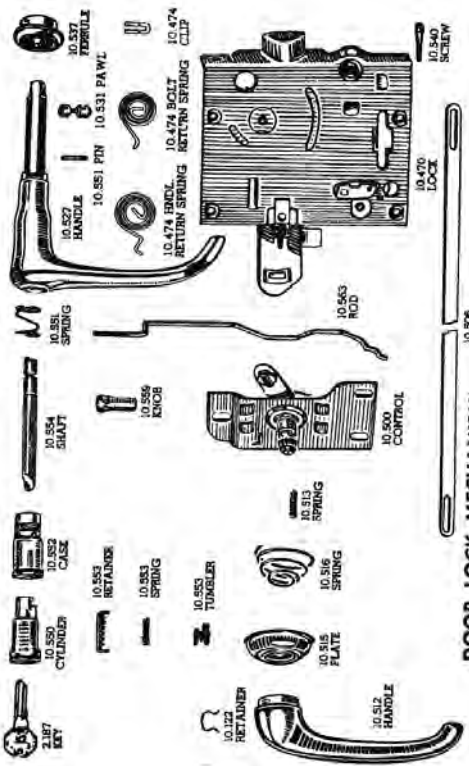

**DOOR LOCK MECHANISM**

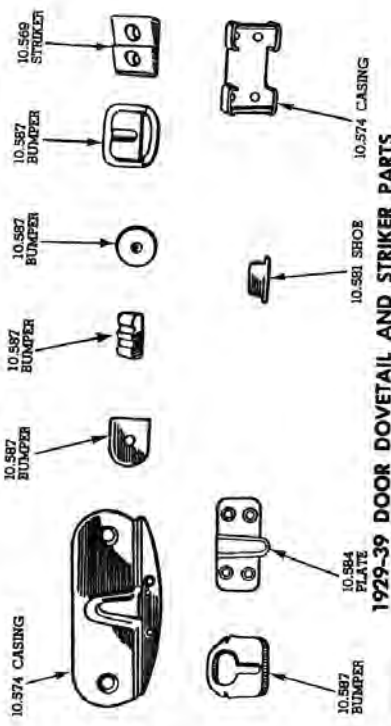

**1929-39 DOOR DOVETAIL AND STRIKER PARTS**

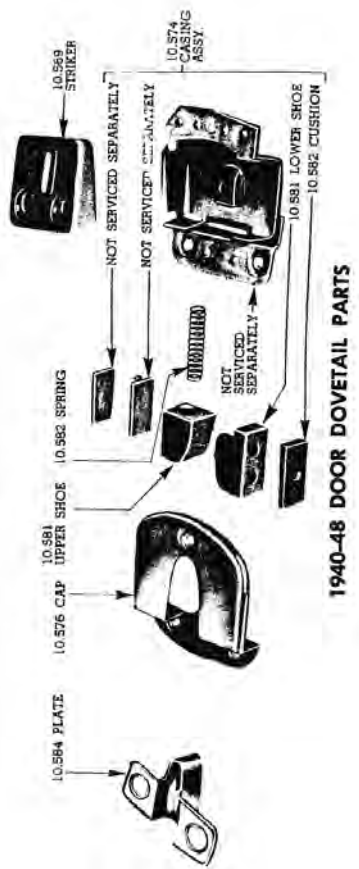

**1940-48 DOOR DOVETAIL PARTS**

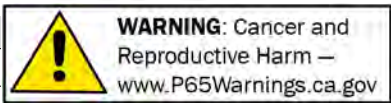

# Section 380C: Door Handles, Armrests, Door Latches & Strikers

10.569 STRIKER

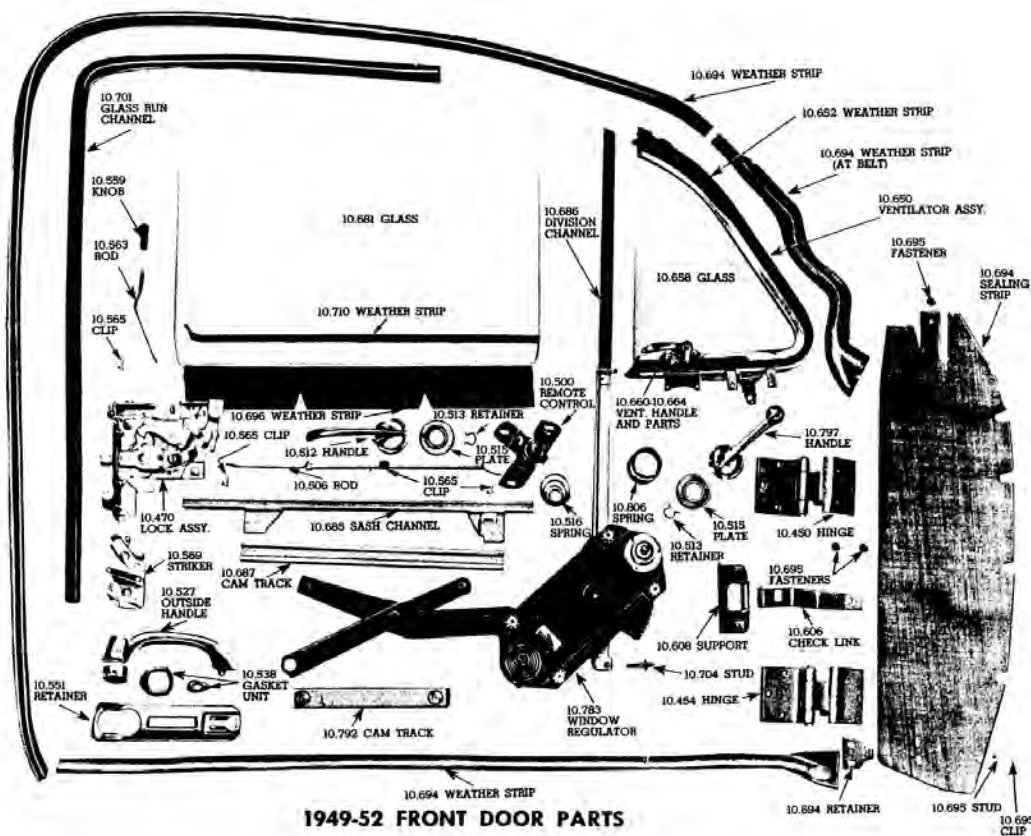

1949-52 FRONT DOOR PARTS

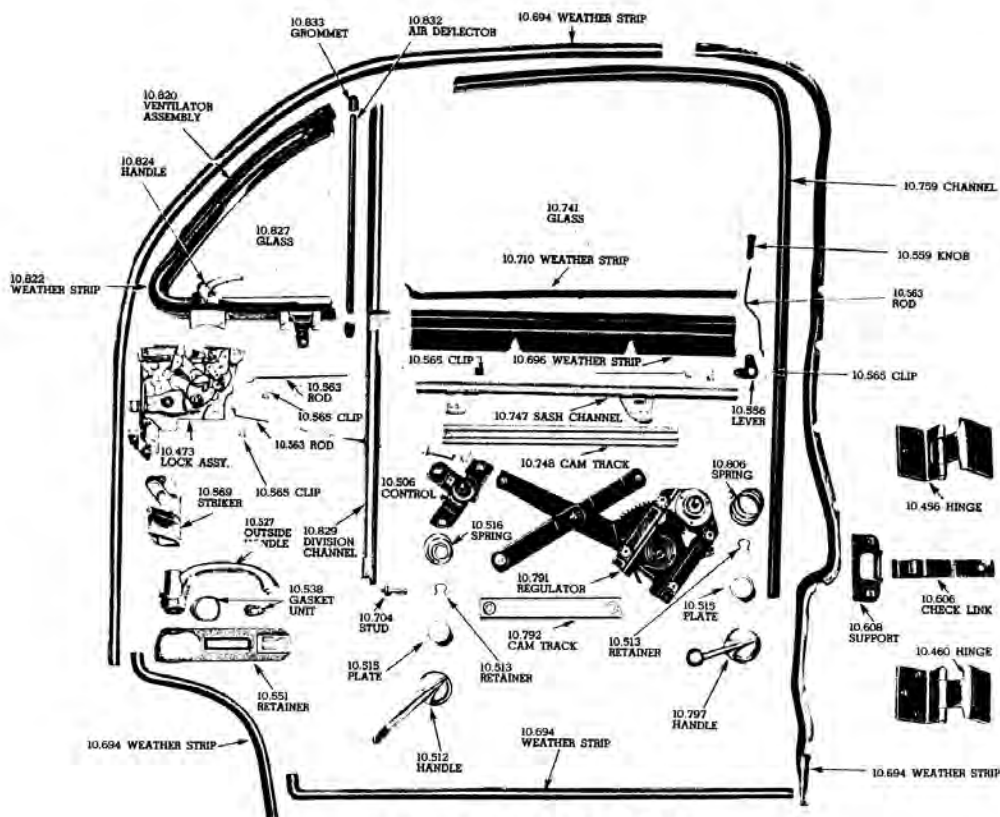

1949-52 REAR DOOR PARTS



**WARNING:** Cancer and Reproductive Harm — [www.P65Warnings.ca.gov](http://www.P65Warnings.ca.gov)

Chemicals shipped domestic ground only (Lower 48 states only). No international shipping.

Phone: (360) 816-0211 • (800) 999-CHEV (2438) • [www.chevsofthe40s.com](http://www.chevsofthe40s.com)



**SECTION 380C  
RESTORATION PARTS**

**Door Lock Buttons**



**4132641.....36-50**  
Superior. Choose black, brown or Grey (specify color when ordering)  
10.559 -0.4 .....starting

at **\$3.25 EA** ⚠



**4571049.....51-60**  
Black, red, blue, turquoise or dark green (specify color when ordering. 2 pcs)  
10.559 -0.15 ..... starting at **\$5.25 SET** ⚠

**Door Pulls**



**DLK70023.....ALL**  
8 Ball Door Lock Knob -0.15  
..... **\$7.75 PR** ⚠



**DLK70044.....ALL**  
Chrome Metal Tube Door Lock Knob -0.2  
..... **\$8.00 PR** ⚠

**Window Flipper**



**4116622.....41**  
Chrome (follows glass down) fits cabriolet only 10.699 -0.15 ..... **\$299.00 EA** ⚠

**Window Flipper Spring**



**4112621B.....41**  
2 per door, Cabriolet 10.699 -0.15 ..... **\$26.00 L&R** ⚠

**Garnish Insert**



**4124459.....41**  
Garnish moulding medallion, ivory insert  
11.086 -0.4 ..... **\$29.00 PR** ⚠

**Garnish Insert, cont.**



**4137864.....42-48**  
Garnish moulding medallion, ivory insert  
11.086 -0.15 ..... **\$10.75 EA** ⚠

**Garnish Clips**



**4090876.....39**  
This u-clip is for the garnish moulding bottom support for Deluxe Master Sedan and Deluxe Master Coupe. 11.133 -0.3  
..... **\$5.50 EA** ⚠



**4112927.....40-48**  
Garnish moulding bottom support u-clips (exc Cabriolet, Fleetline 4-door & wagon)  
11.133 -0.3 ..... **CALL** ⚠



**4112927.....49-57**  
Garnish moulding bottom support u-clips quarter on 2-door Sedan & 49-52 Coupe  
11.133 -0.3 ..... **CALL** ⚠

**Arm Rest Assembly**



**4126327A.....36-52**  
Metal mount brackets and rubber pad for 1 side. Comes with polished stainless trim (4 pcs). Includes 2 screws. Will need to cover. 14.686 -0.15 ..... **\$65.25 EA** ⚠



**4191945RBK.....51-56**  
Includes mounting screws. 14.686 -0.15  
**\$130.00 PR** ⚠

**Arm Rest Assembly, cont.**



**4191945BB.....53-54**  
Beige. Assembled and includes screws & instructions. 14.686 -0.15 ..... **\$79.50 PR** ⚠



**4191945BK.....53-54**  
Black. Assembled and includes screws & instructions. 14.686 -0.15 ..... **\$79.50 PR** ⚠

**Arm Rest Rubber Pad**



**4126327B.....36-52**  
Pad only. 14.686 -0.15  
..... **\$50.25 EA** ⚠

**Arm Rest Metal Bracket**



**4126327C.....36-52**  
Bracket only 14.868 -0.15 ..... **\$40.00 EA** ⚠

**Screws Arm Rest Support**



**072861.....37-54**  
Arm rest support screws (4 pcs).(2) slotted screws, 2-1/2" length (2) phillips head screws 1/2" length. 14.686 -0.2 ..... **\$1.50 SET** ⚠

**Screws Door Handle**



**4556055.....32-48**  
Tapered, retains outside handle (2 pcs).  
10.540 -0.4 ..... **\$6.75 PR** ⚠

**Door Handle Exterior**



**4073900.....37**  
Exterior, locking.  
10.534 -0.2 ..... **\$125.00 EA** ⚠



**4073901.....37**  
Exterior, non-locking  
10.534 -0 ..... **CALL** ⚠



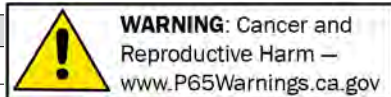

**4089658.....38-39**  
Exterior, locking.  
Original for 38-39, will also fit 1940.  
10.534 -0.15 ..... **\$193.50 EA** ⚠

Returns require a return authorization number—call first. • Product pricing & availability subject to change.





**Door Handle Exterior, cont.**

 **4090147.....38-40**  
Exterior, non-locking handle. Original 38-39 type 10.534 -0.15 ... **CALL** ⚠

 **4125220.....41-46**  
Exterior non-locking. Chrome. Fits all left or right side. 10.534 -0 **\$75.00 EA** ⚠

 **4125377.....41-46**  
Exterior, non-locking handle. Chrome, superior quality! Fits Cabriolet. 10.534 -0 **CALL** ⚠

 **4161122.....47-48**  
Exterior, non-locking. Chrome. Fits all Left & Right 10.534 -0.1 ... **\$75.00 EA** ⚠

 **4161124.....47-48**  
Exterior, non-locking handle. Chrome. Fits Cabriolet. 10.534 -0 **CALL** ⚠

 **4168322.....49-52**  
Exterior, no button, comes with gaskets 10.527 -0.15 ... **\$89.50 L&R** ⚠

 **4150568.....53-54**  
Exterior, no button (exc Hardtop, Wagon, Convertible) 10.527 -0.15 ... **\$92.00 L&R** ⚠

 **4150572.....53-54**  
Exterior, no button. Fits Hardtop & Convertible 10.527 -0.15 ... **\$92.00 L&R** ⚠

**Door Handle Ferrule Grommet**

 **4003748A.....29-37**  
Rubber insert. Fits 29-37 pass car 10.537 -0.15 ... **\$9.75 EA** ⚠

 **4125630A.....38-48**  
Rubber only 10.537 -0.4 ... **\$7.00 EA** ⚠

**Handle Ferrule**

 **4003748.....29-37**  
Chrome, w/ grommet 10.537 -0.4 **\$7.50 EA** ⚠

 **4082056.....38-40**  
Chrome, w/ grommet, outside door handle 10.537 -0.2 ... **\$15.25 EA** ⚠

**Handle Ferrule, cont.**

 **4082056.....41-48**  
Chrome, w/ grommet, Sedan Delivery back door only 10.537 -0.2 ... **\$15.25 EA** ⚠

 **4125630.....41-48**  
Door handle ferrule w/ rubber grommet. Bare (not chrome) 10.537 -0.4 ... **\$7.00 EA** ⚠

**Ferrule Tool**

 **4088134A.....ALL**  
Installs door handle ferrules. Return tool in same condition as sent for a \$20 refund. Does not fit with 4125630 10.537 -0.15 ... **\$50.25 EA** ⚠

**Door Handle Pads 1947-48**

 **4147643A.....47-48**  
For plate under exterior door handle 10.536 -0.3 ... **\$10.25 PR** ⚠

**Chrome Plate**

 **4147642A.....47-48**  
Under exterior door handle. 10.536 -0.4 ... **\$21.25 L&R** ⚠

**Screws Door Handle Plate**  
 **4147643.....47-48**  
Chrome for plate under ext. handle (3 pcs). 21.999 -0 ... **CALL** ⚠

**1949-54 Pads Door Handle**

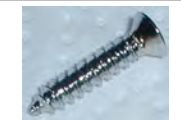
 **3692246.....49-54**  
Door handle & lock, 2-door models 10.536 -0.15 ... **\$4.50 SET** ⚠

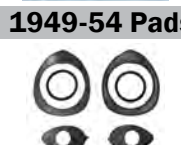
 **3692246B.....49-54**  
Door handle & lock, 4-door models 10.536 -0.4 ... **\$33.50 SET** ⚠

**Door Handle Push Buttons**  
 **3697875.....49-54**  
For front two doors on all 2 door, 4 door and sedan delivery models 10.550 -0.15 ... **\$86.25 SET** ⚠

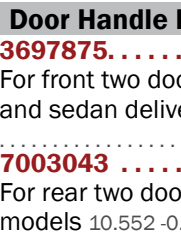
 **7003043.....49-54**  
For rear two doors on 4 door and wagon models 10.552 -0.15 ... **\$44.25 SET** ⚠

**Retainer Door Handle**

 **4561579.....49-52**  
Retainer for door lock cylinder and handle 10.551 -0.15 ... **\$24.75 L&R** ⚠

 **4601481.....53-54**  
Retainer for door lock cylinder and handle. 10.551 -0.15 ... **\$26.50 L&R** ⚠

**Door Handle Guard**

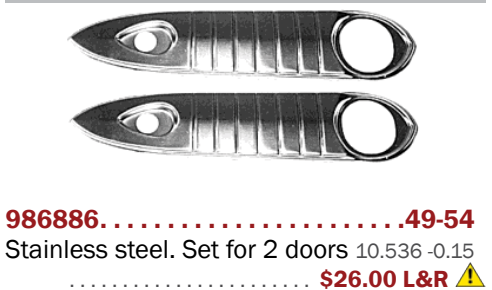
 **986886.....49-54**  
Stainless steel. Set for 2 doors 10.536 -0.15 ... **\$26.00 L&R** ⚠

**Key Blank**

 **601272.....35-54**  
Original GM round head. Fits trunk, glove box & locking gas cap 2.187 -0.2 ... **\$5.25 EA** ⚠

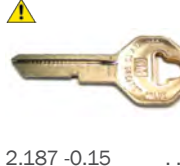
 **3694624.....35-57**  
Original GM octagon head. Fits ignition, door & spare tire locks. 2.187 -0.15 ... **\$3.75 EA** ⚠

**Lock Cylinder**

 **1393155.....41-48**  
W/ keys, outside, left 10.548 -0.15 ... **\$55.00 EA** ⚠

 **1393155B.....41-48**  
W/ matching keys, outside, left & right 10.548 -0.15 ... **\$112.50 PR** ⚠

 **1393156.....41-48**  
Right W/ keys, (use your shaft), works on left but key cover rotates down 10.548 -0.15 ... **\$55.00 EA** ⚠

**Door Lock Retainer**

 **4116527.....39-41**  
Door lock cylinder, spring 10.551 -0 ... **CALL** ⚠

 **4131755.....42-48**  
Door lock cylinder 10.551 -0.3 ... **\$5.25 EA** ⚠

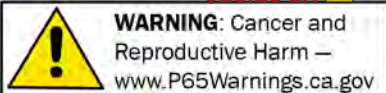

Chemicals shipped domestic ground only (Lower 48 states only). No international shipping.

Phone: (360) 816-0211 • (800) 999-CHEV (2438) • www.chevsofthe40s.com



# Section 380C: Door Handles, Armrests, Door Latches & Strikers

## Door Lock Gasket



**1393155A .....41-48**  
Key, exterior 16.328 -0.2  
..... **\$1.50 EA** ⚠

## Door Lock Spring



**4082041C .....34-37**  
Exterior door lock spring  
10.474 -0.15 .....  
**\$12.00 EA** ⚠



**4082041A .....38-39**  
Exterior door lock return  
spring 10.474 -0.2 ...  
**\$6.00 EA** ⚠



**4102239A ..... 40**  
Exterior door lock return  
spring. 10.474 -0.4 ..  
**\$10.50 EA** ⚠



**4113799A .....41-48**  
Door Lock Arm Spring  
10.563 -0 .. **CALL** ⚠



**4147585 .....41-48**  
Exterior door lock return  
spring 10.474 -0.2 ...  
**\$22.00 EA** ⚠



**4147586 .....41-48**  
Door lock bolt spring  
10.474 -0.2 .....  
**\$22.00 EA** ⚠



**4172043 ..... 49-51**  
Spring - Rear Door Lock  
Lever 10.474 -0.15 ...  
**\$10.00 EA** ⚠



**4183794B ..... 49-51**  
Spring - Front Door Lock  
Lever 10.474 -0.15 ...  
**\$12.00 L&R** ⚠



**4183797 ..... 51-54**  
Spring - Front Door Lock  
Bolt and Hook Return  
10.474 -0.15 .....  
**\$12.00 EA** ⚠

## Door Latch Water Deflector

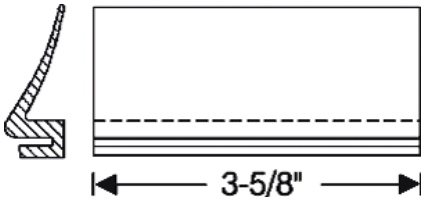

**4099768 .....40-48**  
Rubber, over latch in door 10.470 -0.15  
**\$49.25 PR** ⚠

## Door Latch Rebuild Kit



**4082040A .....37-40**  
Complete for 2 doors (left and right)  
10.473 -0.15 ..... **\$81.00 SET** ⚠

## Door Latch Screws To Door



**431791 .....37-48**  
(8 pcs). 8.907 -0.3 ..... **\$6.00 SET** ⚠

## Door Latch Striker



**4091150 .....37-38**  
Bolt holes 3/4" center-  
to-center 10.569 -0.15  
..... **\$25.00 EA** ⚠



**4131103 .....39-42**  
Fits all 39-40 vehicles &  
41-42 Sedan Delivery  
back door (NORS)  
10.569 -0 .. **CALL** ⚠



**4131103B .....39-42**  
Chrome, spring loaded.  
Fits all 39-40 vehicles &  
41-42 Sedan Delivery  
back door. Bolt holes  
1-1/8" center-to-center. 10.569 -0.2 ..  
**\$34.75 EA** ⚠



**4131103C .....39-42**  
Spring loaded. Fits all  
39-40 vehicles & 41-42  
Sedan Delivery back  
door. Bolt holes 1-1/8"  
center-to-center. 10.569 -0 .. **CALL** ⚠



**4131875C .....41-48**  
Chrome. Bolt holes 1"  
center-to-center.  
10.569 -0.15 .....  
**\$34.50 EA** ⚠



**4604440 .....49-54**  
Right side. Front or rear  
door Cast aluminum.  
10.569 -0.15 .....  
**\$87.00 EA** ⚠



**4604441 .....49-54**  
Left side. Front or Rear  
door, SDL rear door  
Cast aluminum  
10.569 -0.15 .....  
**\$87.00 EA** ⚠

## Door Latch Striker Screws



**4074901 .....37-38**  
Does 2 doors (4 pcs)  
10.570 -0 .. **CALL** ⚠



**4099249 .....40-41**  
Does 2 doors (4 pcs).  
10.570 -0 .. **CALL** ⚠



**4132281 .....42-48**  
Stainless steel (4 pcs)  
10.570 -0.4 .....  
**\$5.00 SET** ⚠



**4587325 .....49-54**  
Stainless steel (4 pcs)  
10.570 -0 .. **CALL** ⚠

## Dovetail Wedge



**2038264 .....37-48**  
Chrome, 37-48 front  
doors, 29-40 rear  
doors, 37-48 Sedan  
Delivery back door, 48  
Wagon front & rear doors 10.584 -0.2  
**\$25.00 EA** ⚠

## Dovetail Wedge Screws



**134417 .....37-48**  
Stainless 10.585 -0.4  
..... **\$15.00 SET** ⚠

## Dovetail Cap



**4090150 .....37-39**  
Chrome, on door jam  
10.576 -0 .. **CALL** ⚠



**4090150P .....37-39**  
Painted, on door jam  
10.576 -0.2 .....  
**\$20.00 EA** ⚠



**4099828 .....40-48**  
Chrome, on door jam  
10.576 -0.3 .....  
**\$24.00 EA** ⚠

**4099828P .....40-48**  
Painted, on front door jam 10.576 -0 ..  
**CALL** ⚠



**4099829P .....41-48**  
Painted, on rear door  
jam 10.576 -0.15 ....  
**\$18.00 EA** ⚠

## Dovetail Casing Rebuild Kit



**409150 .....37-39**  
Door latch rebuild  
kit. Comes w/  
springs for dovetail  
casing assembly  
on door jamb. 1 set  
per door required.  
10.576 -0.15  
..... **\$22.00 PR** ⚠

Returns require a return authorization number—call first. • Product pricing & availability subject to change.

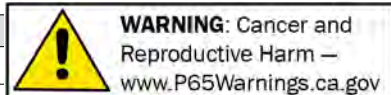

**Dovetail Casing Rebuild Kit, cont.**



**4099832B** ..... **40-48**  
Dovetail Casing Rebuild Kit (In Pillar on Car) Does 2 10.569-0.2 .. **\$46.00 EA** ⚠

**Dovetail Cap Screws**



**165063B** ..... **37-39**  
Stainless on door jam. 10.576-0.4 .....

**\$3.75 SET** ⚠



**165064** ..... **40-48**  
Stainless steel on door jam. 10.576-0.4 .....

**\$4.25 SET** ⚠



**165064A** ..... **40-48**  
Zinc plated on door jam. 10.576-0.4 .....

**\$1.00 SET** ⚠

**Door Lock Rod**



**4114133** ..... **41-48**  
Rod, latch to knob, right front door Exc. Aero 10.563-0 .....

**CALL** ⚠

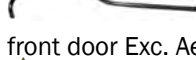

**4114134** ..... **41-48**  
Rod, latch to knob, left front door Exc. Aero 10.563-0 .....

**CALL** ⚠



**4125499** ..... **42-48**  
Door lock rod Aero only, right front door 10.563-0 .....

**CALL** ⚠



**4125500** ..... **42-48**  
Door lock rod Aero only, left door 10.563-0 .....

**CALL** ⚠

**Interior Door Handle**



**4073890** ..... **37-38**  
Chrome handle 10.512-0.15 .....

**\$43.25 EA** ⚠



**4090143** ..... **39**  
Chrome handle 10.512-0 .....

**\$35.00 EA** ⚠



**4102254** ..... **40-48**  
Chrome handle 10.512-0.2 .....

**\$15.00 EA** ⚠



**3703632** ..... **49-57**  
Chrome handle 10.512-0.3 .....

**\$22.50 EA** ⚠

**Interior Door Handle, cont.**



**3703632S** ..... **49-57**  
Superior (includes disk behind handle #4659983) 10.512-0 .....

**CALL** ⚠

**Horseshoe Clips**



**4090144** ..... **39-48**  
Retains inside handles (10 pcs) 10.513-0.4 .....

**\$2.25 SET** ⚠



**4168122** ..... **49-57**  
Retains inside handles (10 pcs) 10.513-0.4 .....

**\$2.75 SET** ⚠

**Handle Clip Tool**



**3703632C** ..... **39-48**  
Removes horseshoe clips-interior handle 10.511-0.3 .....

**\$17.00 EA** ⚠

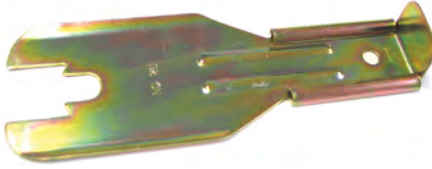

**3703632A** ..... **49-57**  
Removes horseshoe clips-interior handle. 10.511-0.2 .....

**\$5.75 EA** ⚠

**Handle Return Spring**



**4133003A** ..... **40**  
Interior handle, right 10.500-0.4 .....

**\$5.00 EA** ⚠



**4133003B** ..... **40**  
Interior handle, left 10.500-0.4 .....

**\$5.00 EA** ⚠



**4133003C** ..... **41-48**  
Interior handle, right 10.500-0.15 .....

**\$7.75 EA** ⚠



**4133003D** ..... **41-48**  
Interior handle, left 10.500-0.15 .....

**\$8.00 EA** ⚠

**Screws**



**431791B** ..... **41-48**  
Slotted pan head w/ lock washer. Attaches window regulator & interior door handle remote to door (22 pcs). 10.791-0.3 .....

**\$22.00 SET** ⚠

**Escutcheon**



**4073966** ..... **37-38**  
Fits door handle. Chrome 10.805-0 .....

**CALL** ⚠



**4073996** ..... **37-38**  
Fits vent & window handles. Chrome 10.805-0.15 .....

**\$12.00 EA** ⚠



**4090160** ..... **39**  
Fits door & window handles. Rose tan. Concourse Quality. 10.805-0 .....

**\$12.00 EA** ⚠



**4090160E** ..... **39**  
Fits door & window handles. Ivory 10.805-0.4 .....

**\$14.00 EA** ⚠



**4090161** ..... **39**  
Fits door & window handles. Brown (JB) 10.805-0.15 .....

**\$13.75 EA** ⚠



**4102256** ..... **40**  
Fits door & window handles. Brown (KB) 10.805-0 .....

**CALL** ⚠



**4102302** ..... **40**  
Fits door & window handles. Brown/ ivory 10.805-0.15 .....

**\$12.00 EA** ⚠



**4116127** ..... **41**  
Fits door & window handles. Original ivory w/ chrome ring. Concourse quality. 10.805-0.4 .....

**\$12.00 EA** ⚠



**4116127E** ..... **41**  
Fits door & window handles. Ivory w/ chrome ring 10.805-0.3 .....

**\$7.00 EA** ⚠



**4116600A** ..... **42**  
Fits door & window handles. Brown w/ chrome ring 10.805-0.15 .....

**\$16.50 EA** ⚠



**4146889** ..... **46-48**  
Fits door & window handles. Ivory w/ chrome ring 10.805-0.15 .....

**\$14.00 EA** ⚠



**Disk Behind Interior Handles**



**4659983** ..... **49-57**  
Set of 2 10.805-0.15 .....

**\$4.00 SET** ⚠

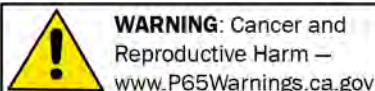

**WARNING: Cancer and Reproductive Harm** — www.P65Warnings.ca.gov

Chemicals shipped domestic ground only (Lower 48 states only). No international shipping.

**Phone: (360) 816-0211 • (800) 999-CHEV (2438) • www.chevsofthe40s.com**



## Section 380C: Door Handles, Armrests, Door Latches & Strikers

## Section 390C: Door Hinges, Check Links, & Sedan Delivery Door Wood Posts

### Tension Springs



**4566746.....37-54**  
Behind inside handles  
(4 pcs) 10.806-0.3  
**\$4.50 SET** ⚠️

### Foam Pressure Washer



**4101894.....28-57**  
Door handle, behind  
inside handles (4 pcs)  
10.517-0.15

**\$7.75 SET** ⚠️

### Odds And Ends

Please call for availability on all Odds & Ends parts. Once part is sold, it may no longer be in stock.

**4082040U.....37-39**  
used right front door latch 33000.000-0  
**\$168.79 EA** ⚠️

**40901474U.....38-39**  
Door handle, non locking. Exterior, left  
side. Fits front or rear exc CBL 10.534-0  
**\$60.00 EA** ⚠️

**4090143U.....39**  
Door handle interior used 10.512-0.4

**\$10.00 EA** ⚠️

**4102254U.....39-48**  
Interior Door Handle (Used) 10.512-0.3  
**\$4.00 EA** ⚠️

**4125919.....41-42**  
Moulding, interior window left side used.  
Has some surface rust. 10.051-0.4  
**\$30.00 EA** ⚠️

**4125220U.....41-46**  
Exterior door handle (Exc CVT & SW).  
Chrome, fits left or right. Good condition  
(Used) 10.534-0  
**\$40.00 EA** ⚠️

**4125377U.....41-48**  
Door handle fits left or right (Used)  
10.534-0  
**\$20.00 EA** ⚠️

**4161122U.....47-48**  
Chrome exterior door handle. Fits all, left  
or right (Used) 10.534-0.4  
**\$30.00 EA** ⚠️

**4168323U.....49-52**  
Exterior door handle (Used). Good  
condition. 10.527-0.4  
**\$30.00 EA** ⚠️

**4150569U.....53-54**  
Door handle left (Used) 10.527-0  
**\$40.00 EA** ⚠️

**4150572U.....53-54**  
Exterior door handle (Used). Good  
condition. 10.527-0.4  
**\$30.00 EA** ⚠️

**4569559.....53-54**  
Door Handle Remote, Front Right (NOS)  
10.500-0.4  
**\$75.00 EA** ⚠️

**4596423.....53-54**  
Door Handle Remote, Right Rear (NOS)  
10.500-0.4  
**\$75.00 EA** ⚠️

**3703632U.....53-56**  
Interior handle (Used) 10.512-0.4  
**\$5.00 EA** ⚠️

**4033996U.....ALL**  
Universal link for remote (Used) 10.506-0.4  
**\$10.00 EA** ⚠️

### SECTION 390C

### RESTORATION PARTS

#### Hinge Pin w/ Bushings



**4023559B.....29-54**  
11/32in. x 2-3/4in. .  
Fits all 35-39 & 30-54

Sedan Delivery back door (3 pcs)  
10.466-0.15  
**\$4.00 EA** ⚠️

**4023559C.....29-54**  
Stainless steel.  
11/32in. x 2-3/8in. .  
Fits all 35-39 & 30-54

Sedan Delivery back door (3 pcs)  
10.466-0.15  
**\$7.75 EA** ⚠️

**4091054B.....40-54**  
Exc Sedan Delivery  
back door (3 pcs)  
10.466-0.3  
**\$3.25 EA** ⚠️

**4091054B.....40-54**  
Exc Sedan Delivery  
back door (3 pcs)  
10.466-0.3  
**\$3.25 EA** ⚠️

#### Door Hinge Bolt



**123473.....37-40**  
Stainless steel bolts. 1  
set does 1 hinge. (6  
pcs) 9/16 Head.  
10.463-0.2

**\$20.00 SET** ⚠️

#### Door Hinge Screws



**4096042.....41-48**  
Stainless steel. 5/16in.  
x 3/4in. , slotted head  
(6 per hinge) 10.463-0.3  
**\$6.75 EA** ⚠️



**4554491.....41-48**  
Stainless steel. 5/16in.  
x 3/4in. , phillips head  
(6 per hinge) 10.463-0.2  
**\$4.00 EA** ⚠️

#### Check Link Stop



**4097396.....37-39**  
W/ cowl post mount. Chrome 10.606-0.15  
**\$45.50 EA** ⚠️

**4091161.....41-48**  
Rectangular, screws on  
10.613-0.15  
**\$30.00 EA** ⚠️

#### Check Link Nuts



**4082335.....37-40**  
With 5/16in. Thick  
Cushions 10.614-0.15  
**\$15.00 SET** ⚠️

### Check Link Cushion



**4110670.....30-48**  
Cars (exc. 42-48 4-door  
& Sedan Delivery front  
doors). Fits 41-42  
Sedan Delivery back

door. 10.613-0.15  
**\$42.25 SET** ⚠️

### Spring Detent Plate



**4114478A.....41**  
Holds door half open. Kit for left & right  
lower hinge 10.450-0.4  
**\$30.50 PR** ⚠️



**4114479A.....41**  
Holds door fully open. Kit for left & right  
upper hinge 10.450-0.3  
**\$25.00 PR** ⚠️



**4156601.....53-58**  
Holds door half open. Kit for one front  
door hinge. 10.450-0.2  
**\$28.75 PR** ⚠️

### Bolt



**4094305.....39-41**  
Screw to attach door  
check link to end at  
cowl 10.624-0.2  
**\$1.50 EA** ⚠️



**4132275.....42-48**  
Front door check-link  
hinge bolt. Mount at  
door post 10.624-0.4  
**\$3.00 EA** ⚠️

### Check Link



**4586827.....49-52**  
Rear door, exc Sedan  
Delivery & Wagon  
10.606-0.15  
**\$22.75 EA** ⚠️



**4600309.....49-52**  
Front door spring. Steel  
10.606-0.15  
**\$20.25 EA** ⚠️

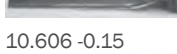

**4600310.....53-54**  
Rear door spring. Steel  
10.606-0.2  
**\$16.00 EA** ⚠️

Returns require a return authorization number—call first. • Product pricing & availability subject to change.



**WARNING:** Cancer and  
Reproductive Harm —  
www.P65Warnings.ca.gov

**Section 390C: Door Hinges, Check Links, & Sedan Delivery Door Wood Posts**

**Section 400C: Door Bumpers, Windlace & Weatherstrip**

**Check Link Support**



**4561013.....49-52**  
 Door check link supports 10.608 -0.2  
 ..... **\$162.50 PR** ⚠️

**Door Frame Wood**



**4111895A.....40**  
 Uprights, Sedan Delivery back door  
 12.968 -0.15 ..... **\$900.00 PR** ⚠️



**4115669A.....41-48**  
 Uprights, Sedan Delivery back door  
 12.968 -0 ..... **CALL** ⚠️

**Top Cross Bar**



**4111895B.....40**  
 Wood, Sedan Delivery back door  
 12.968 -0.15 ..... **\$400.00 EA** ⚠️  
**4115669B.....41-48**  
 Wood, Sedan Delivery back door 12.968 -0  
 ..... **CALL** ⚠️

**Odds & Ends**

Please call for availability on all Odds & Ends parts. Once part is sold, it may no longer be in stock.

**17850.....40**  
 Link Rod, Door Handle Remote, Right  
 10.500 -0.4 ..... **\$17.50 EA** ⚠️  
**4102242.....40**  
 Door Latch Assy, 4-door Left Rear (NOS)  
 33.000 -0.4 ..... **\$35.00 EA** ⚠️  
**4113906.....41-48**  
 Dovetail wedge. Fits 4 door. Left rear only  
 (NOS) 10.584 -0.4 ..... **\$25.00 EA** ⚠️  
**4592733.....49-51**  
 Door Latch Assy, Right Rear (NOS)  
 33.000 -0.4 ..... **\$35.00 EA** ⚠️  
**4150328.....53-54**  
 Hinge Box, Front Door Lower Right  
 33.000 -0.4 ..... **\$30.00 EA** ⚠️  
**4191687.....53-54**  
 Door hinge strap, w/ bushing 10.450 -0 ..  
**\$50.00 L&R** ⚠️

**SECTION 400C  
 RESTORATION PARTS**

**Door Weatherstrip Complete**

Complete Door Weatherstrip Kits w/ specially moulded pieces. Not just sold by the foot. Another example of our effort to provide the best.

**4082250.....37-38**  
 Front doors. 360 degree seal 10.694 -0.15  
 ..... **\$85.00 L&R** ⚠️

**4082250B.....37-38**  
 Rear doors. 360 degree seal 10.694 -0.2  
 ..... **\$35.00 L&R** ⚠️



**3692045A.....37-48**  
 Back door, Sedan  
 Delivery 10.694 -0.3  
 ..... **\$22.50 EA** ⚠️

**4081960.....39**  
 2 front doors, 360 degrees 10.694 -0  
**\$60.00 L&R** ⚠️

**4081960B.....39**  
 2 rear doors, 360 degrees 10.694 -0  
**CALL** ⚠️

**4115115B.....40**  
 Front doors. Exc Cabriolet 10.694 -0  
**CALL** ⚠️

**4115115C.....40**  
 Cabriolet 10.694 -0 ..... **CALL** ⚠️  
**4115115D.....40**  
 Rear doors 10.694 -0 ..... **CALL** ⚠️

**4115115E.....40**  
 Cabriolet w/ upper molded corners.  
 10.694 -0 ..... **CALL** ⚠️

**4114994B.....41**  
 Front doors. Exc Cabriolet 10.694 -0  
**CALL** ⚠️

**4114994C.....41**  
 Cabriolet w/out molded corners 10.694 -0  
 ..... **CALL** ⚠️

**4114994E.....41**  
 Cabriolet. Comes w/ molded upper  
 corners. 10.694 -0 ..... **CALL** ⚠️

**4114994D.....41-48**  
 Rear doors 10.694 -0 ..... **CALL** ⚠️



**4115526BE.....42-48**  
 Except Cabriolet For 2 doors. 10.694 -0.15  
 ..... **\$558.25 L&R** ⚠️



**4115526C.....42-48**  
 Complete w/ upper  
 molded corners. Fits  
 Cabriolet (for 2 doors).  
 10.694 -0 ..... **CALL** ⚠️

**Door Weatherstrip Complete, cont.**

**3692045BE.....49-52**  
 Front doors w/ #4571918 exc Hardtop &  
 Convertible - comes with 3690751  
 10.694 -0.15 ..... **\$343.25 L&R** ⚠️



**4565914.....49-52**  
 Rear doors 10.694 -0.15 ..... **\$241.75 SET**  
 ⚠️

**4606455B.....49-52**  
 Front doors, Hardtop & Convertible, w/  
 4589811 10.694 -0 ..... **\$199.00 L&R** ⚠️  
**3692045.....49-54**  
 Wagon tailgate (upper & lower) 10.694 -0.15

..... **\$22.50 SET** ⚠️  
**4191860B.....53-54**  
 Front, Exc. Hardtop &  
 Convertible. 10.694 -0.15  
 ..... **\$35.00 L&R** ⚠️

**4191860BE.....53-54**  
 Front. Exc Hardtop & Convertible (for 2  
 doors) 10.694 -0.15 ..... **\$189.75 L&R** ⚠️

**4191860C.....53-54**  
 Fits 4-door Sedan &  
 Wagon. Does 4 doors.  
 10.694 -0.3 ..... **\$56.00 SET** ⚠️

**4632297B.....53-54**  
 Hardtop & Convertible,  
 does 2 doors 10.694 -0  
 ..... **CALL** ⚠️

**4632297BE.....53-54**  
 Hardtop & Convertible, does 2 doors.  
 10.694 -0.15 ..... **\$266.00 L&R** ⚠️

**Door Weatherstrip Components**

Note: The below separate components are included in the complete door weatherstrip kits

**4076153.....35-39**  
 Door bottoms w/ clips  
 (4 doors) 10.694 -0.4  
 ..... **\$69.75 SET** ⚠️

**4076153.....35-39**  
 Door bottoms w/ clips  
 (4 doors) 10.694 -0.4  
 ..... **\$69.75 SET** ⚠️

**4076153.....35-39**  
 Door bottoms w/ clips  
 (4 doors) 10.694 -0.4  
 ..... **\$69.75 SET** ⚠️

**4076153.....35-39**  
 Door bottoms w/ clips  
 (4 doors) 10.694 -0.4  
 ..... **\$69.75 SET** ⚠️

**4076153.....35-39**  
 Door bottoms w/ clips  
 (4 doors) 10.694 -0.4  
 ..... **\$69.75 SET** ⚠️

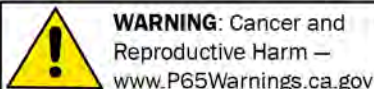

Chemicals shipped domestic ground only (Lower 48 states only). No international shipping.

**Phone: (360) 816-0211 • (800) 999-CHEV (2438) • www.chevsofthe40s.com**

**400C**



# Section 400C: Door Bumpers, Windlace & Weatherstrip

## Door Weatherstrip Components, cont.

**4076153BULK^**.....**35-39**  
 Door bottom weatherstrip sold by the foot  
 10.694 -0 ..... **\$5.00 FT** ⚠

**4076154**.....**35-39**  
 Weatherstrip, door bottoms (2 doors)  
 10.694 -0 ..... **\$48.00 L&R** ⚠



**4082247**.....**35-39**  
 Clip for door bottom weatherstrip. 2-doors (10 pcs) 10.695 -0.4

..... **\$15.00 SET** ⚠

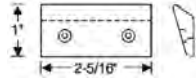

**4074396**.....**37-38**  
 Rubber w/ steel core, 2 screw holes. Seal at door hinge post at dash.

Fits Cabriolet 10.720 -0.15 ..... **\$92.75 PR** ⚠



**4076045**.....**37-38**  
 Clip. Retains side & top weatherstrip (5 pcs)  
 10.695 -0 .....

**\$3.25 SET** ⚠

**4101976**.....**37-38**  
 Fits top & sides of 2 doors 10.694 -0.3

..... **\$28.00 PR** ⚠

**4101976B**.....**37-38**  
 Fits top & sides of 4 doors - Requires 2 kits for 4 doors 10.694 -0.2

**\$35.00 L&R** ⚠

**4075302**.....**37-39**  
 Clip for weatherstrip lower corners (4 pcs)  
 10.695 -0.3 .....

**\$9.75 SET** ⚠

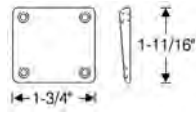

**4076899**.....**37-52**  
 Rubber Wedge. Rear of Convertible & Hardtop door 10.587 -0.15

..... **\$20.00 PR** ⚠

**4131392**.....**39-52**  
 Fits top & sides of front and rear doors. 360 degrees on Sedan Delivery back door

10.694 -0.3 ..... **\$1.50 FT** ⚠



**4102073C**.....**40-41**  
 Molded upper corners for front & rear of Cabriolet door. Perfect to update pre-available

kits (4 pcs). 10.694 -0.15 ..... **\$54.75 SET** ⚠



**4114995**.....**40-41**  
 Molded upper rear corners. Fits Cabriolet.  
 10.694 -0.15 .....

**\$34.25 L&R** ⚠

## Door Weatherstrip Components, cont.



**4115230B**.....**40-48**

Windshield post to vent frame-Cabriolet  
 10.720 -0.15 ..... **\$12.00 SET** ⚠

**4143075**.....**40-48**

Door bottom for both rear doors (7 ft)  
 10.694 -0.15 ..... **CALL** ⚠

**4131392B**.....**40-52**

Weatherstrip for top & sides. 10.694 -0.3

..... **\$1.50 FT** ⚠



**4114994**.....**41**  
 Lower front corners of front doors (2 pcs)  
 10.694 -0.15 .....

**4115115**.....**41-48**  
 Lower front corners of front & rear doors (exc front of 41-48 front doors) 10.694 -0.15

**\$31.00 L&R** ⚠



**4102073B**.....**42-48**  
 Molded upper corners for front & rear of Cabriolet door. Perfect to update pre-available

kits (4 pcs). 10.694 -0 ..... **CALL** ⚠

**4111655**.....**42-48**  
 Door corner, upper rear. Cabriolet 10.694 -0.4

..... **\$46.25 L&R** ⚠

**4115526**.....**42-48**  
 Front (on door) to hinge pillar (6 feet) 10.694 -0.15

..... **\$68.25 SET** ⚠

**3690751**.....**49-52**  
 Door to hinge pillar seal. Die cut sheet. Use w/ weatherstrip-

#3692045B or

#4606455B 8.164 -0.4 ..... **\$40.00 SET** ⚠

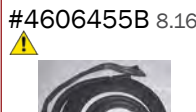

**3692045B**.....**49-52**  
 Front doors exc Hardtop & Convertible -  
 10.694 -0.15 .....

**\$83.50 L&R** ⚠

## Door Weatherstrip Components, cont.



**4571918**.....**49-52**

Door front to hinge pillar below window line (dog leg) exc CBL & HDTP (mounts on door). 10.694 -0.15 ..... **\$124.50 L&R** ⚠



**4589389**.....**49-52**

Metal core weatherstrip. Door front (on hinge post) below window line (dog leg). Exc Convertible & Hardtop 10.694 -0.15

..... **\$183.25 L&R** ⚠



**4589811**.....**49-52**

Front (on door) to hinge pillar below window line (dogleg), Convertible & Hardtop 10.694 -0.15

..... **\$114.50 L&R** ⚠



**4589965B**.....**49-52**

Windshield post to vent frame-Convertible 14.115 -0.15

..... **\$160.50 L&R** ⚠

**4606231**.....**51-52**  
 Lock pillar, Hardtop & Convertible 10.694 -0.15

..... **\$47.75 PR** ⚠

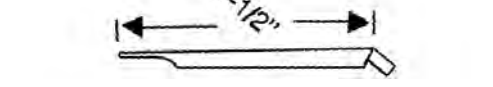

**4610963**.....**52**

Windshield post to vent frame-Hardtop 14.115 -0.15

..... **\$221.00 PR** ⚠

**Windlace Ends**



**4200980.....53-58**  
Hardtop & Convertible  
14.735 -0.15 .....

**\$9.00 L&R** ⚠



**4200980A .....53-58**  
Hardtop & Convertible  
on body, front and back  
of door. 14.735 -0 ...  
**CALL** ⚠

**Door Bumper**



**4063520.....32-41**  
Top front of door,  
screws on 10.591 -0.15

**\$20.75 PR** ⚠



**4035369.....36-60**  
On door post, top rear  
of front door & top front  
of rear door 10.587 -0.4

**\$1.50 PR** ⚠



**3742350.....41-58**  
Top front of door,  
snap-in 10.591 -0.4

**\$5.75 PR** ⚠

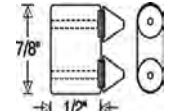

**4564974.....49-57**  
2 prongs, 1/2in. tall (2  
pcs) 10.587 -0.4

**\$4.75 PR** ⚠



**4565415.....49-57**  
To door lock post. Screw  
on. (2 pcs) 10.587 -0.15

**\$19.25 PR** ⚠



**4565415E.....49-57**  
On door lock post.  
Screw on. (2 pieces).  
10.587 -0.15

**\$13.00 PR** ⚠

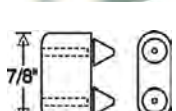

**4565589.....49-57**  
2 prongs, 3/8in. tall (2  
pcs) 10.587 -0.15

**\$11.00 PR** ⚠

**Plug**



**4049538A .....40-48**  
Cabriolet door tension  
adjust hole-bottom rear  
10.380 -0.15

**\$1.50 PR** ⚠

**Roof Rail Seal**

Note: Convertible roof rail weatherstrip see  
Section 510C.



**4605527 ..... 50**

Over door, quarter window & down  
windshield post-Bel Air Hardtop 10.721 -0.15

**\$476.25 L&R** ⚠



**4600737.....50-51**

Over door & down windshield post (not  
over quarter window. Fits Bel-Air Hardtop,  
2nd design. 10.721 -0.15

**\$383.00 L&R**

⚠



**4615011 .....52-54**

Roof flipper to top-Hardtop 10.721 -0.3

**\$40.25 PR** ⚠

**Adhesives And Sealers**



**511114.....ALL**

3M, Black weatherstrip cement, 5-oz tube.  
Superior product!. 8.800 -0.2

**\$23.75 EA** ⚠

**Door Weatherstrip**

**4082250BULK^.....37-38**

Door bottom weatherstrip sold by the foot  
10.694 -0.3

**\$3.00 FT** ⚠

**4101976BULK.....37-38**

Top & sides, sold by the foot 10.694 -0.3

**\$1.00 FT** ⚠

**4143076BULK^.....39-48**

Door weatherstrip sold by the foot 10.694 -0

**CALL** ⚠

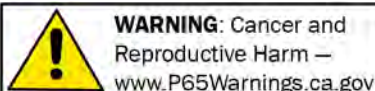



**SECTION 420C  
STREET ROD PARTS**

**One Piece V-bent Windshield Glass**

Note: Oversize shipping charges apply on all windshields. Please call for rate.

Give your car that clean, customized look with a one piece windshield. No more messy silicone sealing the center seam found on V-Butt windshields. All V-Bent windshields come with rubber seal.

|   |                      |
|---|----------------------|
| <b>970V</b> .....   | <b>37-38</b>         |
| Except cabriolet, clear comes w/ rubber seal. 10.027 -0.15 .....                                      | <b>\$540.00 EA</b> ⚠ |
| <b>970VCS</b> .....   | <b>37-38</b>         |
| Except cabriolet. Clear w/ shaded top. Comes with rubber windshield gasket. 10.027 -0.15 .....        | <b>\$580.00 EA</b> ⚠ |
| <b>970VG</b> .....  | <b>37-38</b>         |
| Except cabriolet. Tinted grey 10.027 -0.15 .....  | <b>\$480.00 EA</b> ⚠ |
| <b>970VGS</b> .....   | <b>37-38</b>         |
| Except Cabriolet. Tinted Grey w/ shaded top. Comes with rubber windshield gasket. 10.027 -0.15 .....  | <b>\$499.25 EA</b> ⚠ |
| <b>970VT</b> .....  | <b>37-38</b>         |
| Except cabriolet, tinted green. Comes w/ rubber 10.027 -0.15 .....                                    | <b>\$449.00 EA</b> ⚠ |
| <b>970VTS</b> .....   | <b>37-38</b>         |
| Except cabriolet. Tinted green w/ shaded top. Comes with rubber windshield gasket. 10.027 -0.15 ..... | <b>\$540.00 EA</b> ⚠ |
| <b>1020V</b> .....  | <b>39</b>            |
| Clear. Comes w/ rubber. 10.027 -0.15 ...  | <b>\$448.25 EA</b> ⚠ |
| <b>1020VCS</b> .....  | <b>39</b>            |
| Clear w/ shaded top. Comes w/ rubber seal. 10.027 -0.15 .....   | <b>\$580.00 EA</b> ⚠ |
| <b>1020VG</b> .....   | <b>39</b>            |
| Tinted Grey. Comes w/ rubber seal. 10.027 -0.15 .....   | <b>\$477.00 EA</b> ⚠ |
| <b>1020VGS</b> .....  | <b>39</b>            |
| Tinted grey w/ shaded top. Comes w/ rubber seal. 10.027 -0.15 .....                                   | <b>\$493.00 EA</b> ⚠ |
| <b>1020VT</b> .....   | <b>39</b>            |
| Tinted green. Comes w/ rubber 10.027 -0.15 .....  | <b>\$504.00 EA</b> ⚠ |
| <b>1020VTS</b> .....  | <b>39</b>            |
| Tinted green w/ shaded top. Comes w/ rubber seal. 10.027 -0.15 .....                                  | <b>\$421.25 EA</b> ⚠ |
| <b>1007V</b> .....  | <b>40</b>            |
| Clear. Comes w/ rubber seal. 10.027 -0.15 .....   | <b>\$540.00 EA</b> ⚠ |
| <b>1007VCS</b> .....  | <b>40</b>            |
| Clear w/ shaded top. Comes w/ rubber seal. 10.027 -0.15 .....   | <b>\$520.00 EA</b> ⚠ |
| <b>1007VG</b> .....   | <b>40</b>            |
| Tinted grey. Comes w/ rubber seal. 10.027 -0.15 .....   | <b>\$600.00 EA</b> ⚠ |
| <b>1007VGS</b> .....  | <b>40</b>            |
| Tinted grey with shaded top. Comes w/ rubber seal. 10.027 -0.15 .....                                 | <b>\$580.00 EA</b> ⚠ |

**One Piece V-bent Windshield Glass, cont.**

|  |                      |
|--|----------------------|
| <b>1007VT</b> .....  | <b>40</b>            |
| Tinted green. Comes w/ rubber seal. 10.027 -0.15 .....   | <b>\$520.00 EA</b> ⚠ |
| <b>1007VTS</b> .....   | <b>40</b>            |
| Tinted green with shaded top. Comes w/ rubber seal. 10.027 -0.15 .....                             | <b>\$529.99 EA</b> ⚠ |
| <b>1019V</b> .....   | <b>41-48</b>         |
| Except 2-door Fleetline. Clear, comes with rubber seal 10.027 -0.15 .....                          | <b>\$500.00 EA</b> ⚠ |
| <b>1019VCS</b> .....   | <b>41-48</b>         |
| Clear w/ shaded top. Except 2-door Fleetline. Comes w/ rubber seal. 10.027 -0.15 .....             | <b>\$530.00 EA</b> ⚠ |
| <b>1019VG</b> .....  | <b>41-48</b>         |
| Except 2-door Fleetline. Tinted grey 10.027 -0.15 .....  | <b>\$590.00 EA</b> ⚠ |
| <b>1019VGS</b> .....   | <b>41-48</b>         |
| Except 2-door Fleetline. Tinted grey w/ shaded top. Comes w/ rubber seal. 10.027 -0.15 .....       | <b>\$560.00 EA</b> ⚠ |
| <b>1019VT</b> .....  | <b>41-48</b>         |
| Except 2-door Fleetline. Tinted green, comes w/ rubber seal 10.027 -0.15 .....                     | <b>\$500.50 EA</b> ⚠ |
| <b>1019VTS</b> .....   | <b>41-48</b>         |
| Tinted green w/ shaded top. Except 2-door Fleetline. Comes w/ rubber seal. 10.027 -0.15 .....      | <b>\$535.75 EA</b> ⚠ |
| <b>1042V</b> .....   | <b>42-48</b>         |
| Clear. Fits 2 door Fleetline Aerosedan. Comes w/ rubber seal. 10.027 -0 ..                         | <b>CALL</b> ⚠        |
| <b>1042VCS</b> .....   | <b>42-48</b>         |
| Clear w/ shaded top. Fits 2 door Fleetline Aerosedan. Comes w/ rubber seal. 10.027 -0 .....        | <b>CALL</b> ⚠        |
| <b>1042VT</b> .....  | <b>42-48</b>         |
| Tinted green. Fits 2 door Fleetline Aerosedan. Comes w/ rubber seal. 10.027 -0 .....               | <b>CALL</b> ⚠        |
| <b>1042VTS</b> .....   | <b>42-48</b>         |
| Tinted green w/ shaded top. Fits 2 door Fleetline Aerosedan. Comes w/ rubber seal. 10.027 -0 ..... | <b>CALL</b> ⚠        |

**One Piece Curved Windshield Glass**

|   |                      |
|---|----------------------|
| <b>DW187</b> .....  | <b>49-52</b>         |
| Styleline (exc Convertible, Hardtop & Wagon). 1 piece for customs. Clear. 10.027 -0.15 .....                          | <b>\$399.75 EA</b> ⚠ |
| <b>DW187G</b> .....   | <b>49-52</b>         |
| Fits Styleline (exc Convertible, Hardtop & Wagon). 1 piece for customs. Tinted Grey. 10.027 -0.15 .....               | <b>\$418.25 EA</b> ⚠ |
| <b>DW187GS</b> .....  | <b>49-52</b>         |
| Fits Styleline (exc Convertible, Hardtop & Wagon). 1 piece for customs. Tinted Grey w/ shaded top. 10.027 -0.15 ..... | <b>\$452.25 EA</b> ⚠ |

**One Piece Curved Windshield Glass, cont.**

|  |                      |
|--|----------------------|
| <b>DW187S</b> .....  | <b>49-52</b>         |
| Fits Styleline (exc Convertible, Hardtop & Wagon). 1 piece for customs. Tinted Green w/ shaded top. 10.027 -0.15 ..... | <b>\$482.50 EA</b> ⚠ |
| <b>DW187T</b> .....  | <b>49-52</b>         |
| Fits Styleline (exc Convertible, Hardtop & Wagon). 1 piece for customs. Tinted Green. 10.027 -0.15 .....               | <b>\$392.00 EA</b> ⚠ |
| <b>DW188</b> .....   | <b>49-52</b>         |
| Fits Fleetline Aerosedan-1 piece for customs. Clear. 10.027 -0.15 .....  | <b>\$410.00 EA</b> ⚠ |
| <b>DW188G</b> .....  | <b>49-52</b>         |
| Fits Fleetline Aerosedan. 1 piece for customs. Tinted Grey. 10.027 -0.15 .....   | <b>\$428.25 EA</b> ⚠ |
| <b>DW188GS</b> .....   | <b>49-52</b>         |
| Fits Fleetline Aerosedan. 1 piece for customs. Tinted Grey w/ shaded top. 10.027 -0.15 .....                           | <b>\$462.00 EA</b> ⚠ |
| <b>DW188S</b> .....  | <b>49-52</b>         |
| Fits Fleetline Aerosedan. 1 piece for customs. Tinted Green w/ shaded top. 10.027 -0.15 .....                          | <b>\$432.25 EA</b> ⚠ |
| <b>DW188T</b> .....  | <b>49-52</b>         |
| Fits Fleetline Aerosedan. 1 piece for customs. Tinted Green 10.027 -0.15 .....   | <b>\$402.00 EA</b> ⚠ |
| <b>DW189</b> .....   | <b>49-52</b>         |
| Fits Convertible & Hardtop. 1 piece for customs. Clear. 10.027 -0.15 .....   | <b>\$410.00 EA</b> ⚠ |
| <b>DW189G</b> .....  | <b>49-52</b>         |
| Fits Convertible & Hardtop. 1 piece for customs. Tinted Grey. 10.027 -0.15 .....                                       | <b>\$392.00 EA</b> ⚠ |
| <b>DW189GS</b> .....   | <b>49-52</b>         |
| Fits Convertible & Hardtop. 1 piece for customs. Tinted Grey w/ shaded top. 10.027 -0.15 .....                         | <b>\$472.50 EA</b> ⚠ |
| <b>DW189S</b> .....  | <b>49-52</b>         |
| Fits Convertible & Hardtop. 1 piece for customs. Tinted Green w/ shaded top. 10.027 -0.15 .....                        | <b>\$442.25 EA</b> ⚠ |
| <b>DW189T</b> .....  | <b>49-52</b>         |
| Fits Convertible & Hardtop. 1 piece for customs. Tinted Green. 10.027 -0.15 .....                                      | <b>\$472.50 EA</b> ⚠ |

**SECTION 420C  
RESTORATION PARTS**

**Windshield Glass**

Note: Oversize shipping charges apply on all windshields. Please call for rate.

|   |                      |
|---|----------------------|
| <b>969</b> .....  | <b>37-38</b>         |
| Cabriolet. Clear. 10.027 -0.15 .....                    | <b>\$76.25 EA</b> ⚠  |
| <b>969S</b> .....                                       | <b>37-38</b>         |
| Fits Cabriolet. Green w/ shaded top. 10.027 -0.15 ..... | <b>\$121.25 EA</b> ⚠ |

Returns require a return authorization number—call first. • Product pricing & availability subject to change.

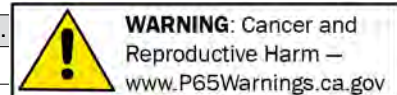

**Windshield Glass, cont.**

|   |                      |
|---|----------------------|
| <b>969T</b> .....   | <b>37-38</b>         |
| Cabriolet, Tinted Green 10.027 -0.15                                      | .....                |
| <b>\$82.00 EA</b> ⚠   |                      |
| <b>970</b> .....  | <b>37-38</b>         |
| Except Cabriolet, Clear 10.027 -0.15                                      | .....                |
| <b>\$72.00 EA</b> ⚠   |                      |
| <b>970G</b> .....   | <b>37-38</b>         |
| Except Cabriolet. Tinted Grey 10.027 -0.15                                | .....                |
| <b>\$74.00 EA</b> ⚠   |                      |
| <b>970GS</b> .....  | <b>37-38</b>         |
| Except Cabriolet. Tinted Grey, w/ shaded top. 10.027 -0.15                | .....                |
| <b>\$160.00 PR</b> ⚠  |                      |
| <b>970S</b> .....   | <b>37-38</b>         |
| Exc Cabriolet. Clear w/ shaded top. 10.027 -0.15                          | .....                |
| <b>\$72.00 EA</b> ⚠   |                      |
| <b>970T</b> .....   | <b>37-38</b>         |
| Except Cabriolet, Tinted Green 10.027 -0.15                               | .....                |
| <b>\$72.00 EA</b> ⚠   |                      |
| <b>970TS</b> .....  | <b>37-38</b>         |
| Except Cabriolet, Tinted Green With Shaded Top. Sold as a pair. 10.027 -0 | ..                   |
| <b>\$160.00 PR</b> ⚠  |                      |
| <b>1020</b> .....   | <b>39</b>            |
| Clear 10.027 -0.15  | .....                |
| <b>\$64.00 EA</b> ⚠   |                      |
| <b>1020G</b> .....  | <b>39</b>            |
| Tinted Grey 10.027 -0.15  | ..                   |
| <b>\$72.00 EA</b> ⚠   |                      |
| <b>1020GS</b> .....   | <b>39</b>            |
| Tinted Grey w/ shaded top. 10.027 -0.15                                   | .....                |
| <b>\$160.00 PR</b> ⚠  |                      |
| <b>1020S</b> .....  | <b>39</b>            |
| Tinted Green w/ shaded top. 10.027 -0.15                                  | .....                |
| <b>\$144.00 PR</b> ⚠  |                      |
| <b>1020T</b> .....  | <b>39</b>            |
| Tinted Green. 10.027 -0.15  | <b>\$72.00 EA</b> ⚠  |
| <b>1007G</b> .....  | <b>40</b>            |
| Tinted Grey 10.027 -0.15  | ..                   |
| <b>\$72.00 EA</b> ⚠   |                      |
| <b>1007GS</b> .....   | <b>40</b>            |
| Tinted Grey w/ shaded top. 10.027 -0.15                                   | .....                |
| <b>\$160.00 PR</b> ⚠  |                      |
| <b>1007S</b> .....  | <b>40</b>            |
| Clear 10.027 -0.15  | .....                |
| <b>\$72.00 EA</b> ⚠   |                      |
| <b>1007SS</b> .....   | <b>40</b>            |
| Clear w/ shaded top. 10.027 -0.15   | .....                |
| <b>\$72.00 EA</b> ⚠   |                      |
| <b>1007ST</b> .....   | <b>40</b>            |
| Tinted Green 10.027 -0.15   | ..                   |
| <b>\$64.00 EA</b> ⚠   |                      |
| <b>1019GS</b> .....   | <b>41-48</b>         |
| Exc 2-door Fleetline. Tinted Grey w/ shaded top. 10.027 -0.15             | <b>\$164.75 PR</b> ⚠ |
| <b>1019GT</b> .....   | <b>41-48</b>         |
| Exc 2-door Fleetline. Tinted Grey. 10.027 -0.15                           | .....                |
| <b>\$80.00 EA</b> ⚠   |                      |
| <b>1019S</b> .....  | <b>41-48</b>         |
| Exc 2-door Fleetline. Clear 10.027 -0.15                                  | ..                   |
| <b>\$72.00 EA</b> ⚠   |                      |
| <b>1019SS</b> .....   | <b>41-48</b>         |
| Exc 2-door Fleetline. Tinted Green w/ shaded top. 10.027 -0.15            | <b>\$219.75 EA</b> ⚠ |
| <b>1019ST</b> .....   | <b>41-48</b>         |
| Exc 2-door Fleetline. Tinted Green 10.027 -0.15                           | .....                |
| <b>\$64.00 EA</b> ⚠   |                      |

**Windshield Glass, cont.**

|   |                      |
|---|----------------------|
| <b>1042S</b> .....  | <b>42-48</b>         |
| Fleetline Aerosedan 2-door. Clear. 10.027 -0.15                                     | .....                |
| <b>\$72.00 EA</b> ⚠   |                      |
| <b>1042SG</b> .....   | <b>42-48</b>         |
| Fleetline Aerosedan 2-door. Grey. 10.027 -0   | .....                |
| <b>\$72.00 EA</b> ⚠   |                      |
| <b>1042SGG</b> .....  | <b>42-48</b>         |
| Fleetline Aerosedan 2-door. Grey w/ gray shaded top. 10.027 -0                      | .....                |
| <b>\$80.00 EA</b> ⚠   |                      |
| <b>1042ST</b> .....   | <b>42-48</b>         |
| Fleetline Aerosedan 2-door. Tinted Green. 10.027 -0.15                              | .....                |
| <b>\$64.00 EA</b> ⚠   |                      |
| <b>DW109</b> .....  | <b>49-52</b>         |
| Styleline (exc conv & hardtop), right side. Clear 10.027 -0.15                      | .....                |
| <b>\$230.00 EA</b> ⚠  |                      |
| <b>DW109G</b> .....   | <b>49-52</b>         |
| Styleline (exc conv & hardtop), right side. Tinted Grey 10.027 -0.15                | <b>\$261.25 EA</b> ⚠ |
| <b>DW109GS</b> .....  | <b>49-52</b>         |
| Styleline (exc conv & hardtop), right side. Tinted Grey w/ shaded top. 10.027 -0.15 | <b>\$261.25 EA</b> ⚠ |
| <b>DW109S</b> .....   | <b>49-52</b>         |
| Styleline (exc conv & hardtop), right side. Green w/ shaded top. 10.027 -0.15       | .....                |
| <b>\$270.00 EA</b> ⚠  |                      |
| <b>DW109T</b> .....   | <b>49-52</b>         |
| Styleline (exc conv & hardtop), right side. Tinted Green 10.027 -0.15               | .....                |
| <b>\$257.25 EA</b> ⚠  |                      |



|   |                      |
|---|----------------------|
| <b>DW110</b> .....  | <b>49-52</b>         |
| Styleline (exc conv & hardtop), left side. Clear 10.027 -0.15                     | .....                |
| <b>\$230.00 EA</b> ⚠  |                      |
| <b>DW110G</b> .....   | <b>49-52</b>         |
| Styleline (exc conv & hardtop), left side. Tinted Grey 10.027 -0.15               | <b>\$261.25 EA</b> ⚠ |
| <b>DW110GS</b> .....  | <b>49-52</b>         |
| Styleline (exc conv & hardtop), left side. Tinted Grey w/ shaded top 10.027 -0.15 | <b>\$261.25 EA</b> ⚠ |
| <b>DW110S</b> .....   | <b>49-52</b>         |
| Styleline (exc conv & hardtop), left side. Green w/ shaded top 10.027 -0.15       | .....                |
| <b>\$270.00 EA</b> ⚠  |                      |
| <b>DW110T</b> .....   | <b>49-52</b>         |
| Styleline (exc conv & hardtop), left side. Tinted Green 10.027 -0.15              | .....                |
| <b>\$257.25 EA</b> ⚠  |                      |
| <b>DW111</b> .....  | <b>49-52</b>         |
| Fleetline, right side. Clear 10.027 -0.15   | .....                |
| <b>\$257.50 EA</b> ⚠  |                      |
| <b>DW111G</b> .....   | <b>49-52</b>         |
| Fleetline, right side. Tinted Grey 10.027 -0.15                                   | .....                |
| <b>\$247.25 EA</b> ⚠  |                      |

**Windshield Glass, cont.**

|   |                      |
|---|----------------------|
| <b>DW111GS</b> .....  | <b>49-52</b>         |
| Fleetline, right side. Tinted Grey w/ shaded top 10.027 -0.15             | <b>\$261.25 EA</b> ⚠ |
| <b>DW111S</b> .....   | <b>49-52</b>         |
| Fleetline, right side. Tinted Green w/ shaded top 10.027 -0.15            | <b>\$251.29 EA</b> ⚠ |
| <b>DW111T</b> .....   | <b>49-52</b>         |
| Fleetline, right side. Tinted Green 10.027 -0.15                          | .....                |
| <b>\$237.25 EA</b> ⚠  |                      |
| <b>DW112</b> .....  | <b>49-52</b>         |
| Fleetline, left side. Clear 10.027 -0.15                                  | .....                |
| <b>\$257.50 EA</b> ⚠  |                      |
| <b>DW112G</b> .....   | <b>49-52</b>         |
| Fleetline, left side. Tinted Grey 10.027 -0.15                            | .....                |
| <b>\$247.25 EA</b> ⚠  |                      |
| <b>DW112GS</b> .....  | <b>49-52</b>         |
| Fleetline, left side. Tinted Grey w/ shaded top 10.027 -0.15              | <b>\$261.25 EA</b> ⚠ |
| <b>DW112S</b> .....   | <b>49-52</b>         |
| Fleetline, left side. Tinted Green w/ shaded top 10.027 -0.15             | <b>\$251.25 EA</b> ⚠ |
| <b>DW112T</b> .....   | <b>49-52</b>         |
| Fleetline, left side. Tinted Green 10.027 -0.15                           | .....                |
| <b>\$237.25 EA</b> ⚠  |                      |
| <b>DW113</b> .....  | <b>49-52</b>         |
| Convertible, Hardtop. Right side. Clear 10.027 -0.15                      | .....                |
| <b>\$260.00 EA</b> ⚠  |                      |
| <b>DW113G</b> .....   | <b>49-52</b>         |
| Convertible, Hardtop. Right side. Tinted Grey 10.027 -0.15                | <b>\$257.25 EA</b> ⚠ |
| <b>DW113GS</b> .....  | <b>49-52</b>         |
| Convertible & Hardtop. Right side. Tinted Grey w/ shaded top 10.027 -0.15 | .....                |
| <b>\$269.50 EA</b> ⚠  |                      |
| <b>DW113S</b> .....   | <b>49-52</b>         |
| Convertible, Hardtop. Right side. Green w/ shaded top 10.027 -0.15        | <b>\$259.25 EA</b> ⚠ |
| <b>DW113T</b> .....   | <b>49-52</b>         |
| Convertible, Hardtop. Right side. Tinted Green 10.027 -0.15               | .....                |
| <b>\$246.00 EA</b> ⚠  |                      |
| <b>DW114</b> .....  | <b>49-52</b>         |
| Convertible, Hardtop. Left side. Clear 10.027 -0.15                       | .....                |
| <b>\$260.00 EA</b> ⚠  |                      |
| <b>DW114G</b> .....   | <b>49-52</b>         |
| Convertible, Hardtop. Left side. Tinted Grey 10.027 -0.15                 | <b>\$257.25 EA</b> ⚠ |
| <b>DW114GS</b> .....  | <b>49-52</b>         |
| Convertible, Hardtop. Left side. Tinted Grey w/ shaded top 10.027 -0.15   | .....                |
| <b>\$269.50 EA</b> ⚠  |                      |
| <b>DW114S</b> .....   | <b>49-52</b>         |
| Convertible, Hardtop. Left side. Tinted Green w/ shaded top 10.027 -0.15  | .....                |
| <b>\$259.25 EA</b> ⚠  |                      |
| <b>DW114T</b> .....   | <b>49-52</b>         |
| Convertible, Hardtop. Left side. Tinted Green 10.027 -0.15                | .....                |
| <b>\$246.00 EA</b> ⚠  |                      |
| <b>DW115</b> .....  | <b>49-52</b>         |
| Wagon. Right side. Clear 10.027 -0.15                                     | ..                   |
| <b>\$287.75 EA</b> ⚠  |                      |

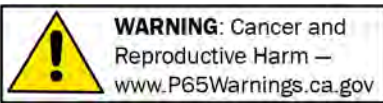

Chemicals shipped domestic ground only (Lower 48 states only). No international shipping.

**Phone: (360) 816-0211 • (800) 999-CHEV (2438) • www.chevsofthe40s.com**



# Section 420C: Glass

## Windshield Glass, cont.

|  |              |
|--|--------------|
| <b>DW115S</b> .....  | <b>49-52</b> |
| Wagon. Right side. Tinted Green w/<br>shaded top 10.027 -0.15 <b>\$250.00 EA</b> ⚠                           |              |
| <b>DW115T</b> .....  | <b>49-52</b> |
| Wagon. Right side. Tinted Green<br>10.027 -0.15 <b>\$260.00 EA</b> ⚠   |              |
| <b>DW116</b> .....   | <b>49-52</b> |
| Wagon. Left side. Clear 10.027 -0.15<br><b>\$287.75 EA</b> ⚠   |              |
| <b>DW116S</b> .....  | <b>49-52</b> |
| Wagon. Left side. Tinted Green w/ shaded<br>top. 10.027 -0.15 <b>\$250.00 EA</b> ⚠                           |              |
| <b>DW116T</b> .....  | <b>49-52</b> |
| Wagon. Left side. Tinted Green 10.027 -0.15<br><b>\$260.00 EA</b> ⚠  |              |
| <b>DW317</b> .....   | <b>53-54</b> |
| Coupe, 2 & 4 door Sedan, Sedan Delivery.<br>Clear. 10.027 -0.15 <b>\$460.00 EA</b> ⚠                         |              |
| <b>DW317G</b> .....  | <b>53-54</b> |
| Coupe, 2 & 4 door Sedan, Sedan Delivery.<br>Tinted Grey. 10.027 -0.15 <b>\$468.50 EA</b> ⚠                   |              |
| <b>DW317GS</b> .....   | <b>53-54</b> |
| Coupe, 2 & 4 Door Sedan, Sedan<br>Delivery. Tinted Grey w/ shaded top.<br>10.027 -0.15 <b>\$432.25 EA</b> ⚠  |              |
| <b>DW317T</b> .....  | <b>53-54</b> |
| Coupe, 2 & 4 door Sedan, Sedan Delivery.<br>Tinted Green. 10.027 -0.15 <b>\$382.00 EA</b> ⚠                  |              |
| <b>DW317TS</b> .....   | <b>53-54</b> |
| Coupe, 2 & 4 Door Sedan, Sedan<br>Delivery. Tinted Green w/ shaded top.<br>10.027 -0.15 <b>\$442.25 EA</b> ⚠ |              |
| <b>DW318</b> .....   | <b>53-54</b> |
| Convertible & Hardtop. Clear 10.027 -0.15<br><b>\$418.00 EA</b> ⚠  |              |
| <b>DW318G</b> .....  | <b>53-54</b> |
| Convertible & Hardtop. Tinted Grey<br>10.027 -0.15 <b>\$418.25 EA</b> ⚠                                      |              |
| <b>DW318GS</b> .....   | <b>53-54</b> |
| Convertible & Hardtop. Tinted Grey w/<br>shaded top 10.027 -0.15 <b>\$452.25 EA</b> ⚠                        |              |
| <b>DW318S</b> .....  | <b>53-54</b> |
| Convertible & Hardtop. Tinted Green w/<br>shaded top. 10.027 -0.15 <b>\$490.50 EA</b> ⚠                      |              |
| <b>DW318T</b> .....  | <b>53-54</b> |
| Convertible & Hardtop. Tinted Green<br>10.027 -0.15 <b>\$392.00 EA</b> ⚠                                     |              |
| <b>DW319</b> .....   | <b>53-54</b> |
| Wagon. Clear 10.027 -0.15 <b>\$428.50 EA</b> ⚠   |              |
| <b>DW319G</b> .....  | <b>53-54</b> |
| Wagon. Tinted Grey 10.027 -0.15<br><b>\$438.25 EA</b> ⚠  |              |
| <b>DW319GS</b> .....   | <b>53-54</b> |
| Wagon. Tinted Grey w/ shaded top<br>10.027 -0.15 <b>\$472.50 EA</b> ⚠  |              |
| <b>DW319S</b> .....  | <b>53-54</b> |
| Wagon. Tinted Green w/ shaded top<br>10.027 -0.15 <b>\$442.00 EA</b> ⚠                                       |              |

## Windshield Glass, cont.

|  |              |
|--|--------------|
| <b>DW319T</b> .....  | <b>53-54</b> |
| Wagon. Tinted Green 10.027 -0.15<br><b>\$412.00 EA</b> ⚠                   |              |
| <b>Front Door Vent Glass</b>   |              |
| <b>2714</b> .....  | <b>37-38</b> |
| Cabriolet. Clear 10.658 -0.15 <b>\$30.00 EA</b> ⚠                          |              |
| <b>2714D</b> .....   | <b>37-38</b> |
| Cabriolet. Tinted Grey -0.15 <b>\$34.00 EA</b> ⚠                           |              |
| <b>2714T</b> .....   | <b>37-38</b> |
| Cabriolet. Tinted Green 10.658 -0.15<br><b>\$30.00 EA</b> ⚠                |              |
| <b>2717</b> .....  | <b>37-39</b> |
| Exc Cabriolet. Clear 10.658 -0.15<br><b>\$34.00 EA</b> ⚠                   |              |
| <b>2717D</b> .....   | <b>37-39</b> |
| Exc Cabriolet. Tinted Grey -0.15<br><b>\$40.00 EA</b> ⚠                    |              |
| <b>2717T</b> .....   | <b>37-39</b> |
| Exc Cabriolet. Tinted Green 10.658 -0.15<br><b>\$34.00 EA</b> ⚠            |              |
| <b>2524S</b> .....   | <b>40</b>    |
| Cabriolet. Clear 10.658 -0.15 <b>\$30.00 EA</b> ⚠                          |              |
| <b>2524SD</b> .....  | <b>40</b>    |
| Cabriolet. Tinted Grey -0.15 <b>\$34.00 EA</b> ⚠                           |              |
| <b>2524ST</b> .....  | <b>40</b>    |
| Cabriolet. Tinted Green 10.658 -0.15<br><b>\$30.00 EA</b> ⚠                |              |
| <b>2525S</b> .....   | <b>40</b>    |
| Exc Cabriolet 10.658 -0.15 <b>\$34.00 EA</b> ⚠                             |              |
| <b>2525SD</b> .....  | <b>40</b>    |
| Exc. Cabriolet. Grey tint -0.15<br><b>\$32.00 EA</b> ⚠                     |              |
| <b>2525ST</b> .....  | <b>40</b>    |
| Exc. Cabriolet. Green tint -0.15<br><b>\$28.00 EA</b> ⚠                    |              |
| <b>2563S</b> .....   | <b>41-48</b> |
| Exc Fleetline, Cabriolet. Clear 10.658 -0.15<br><b>\$34.00 EA</b> ⚠        |              |
| <b>2563SD</b> .....  | <b>41-48</b> |
| Exc Fleetline, Cabriolet. Tinted Grey -0.15<br><b>\$32.00 EA</b> ⚠         |              |
| <b>2563ST</b> .....  | <b>41-48</b> |
| Exc Fleetline, Cabriolet. Tinted Green<br>10.658 -0.15 <b>\$34.00 EA</b> ⚠ |              |
| <b>2564S</b> .....   | <b>41-48</b> |
| Cabriolet. Clear 10.658 -0.15 <b>\$57.75 EA</b> ⚠                          |              |
| <b>2564SD</b> .....  | <b>41-48</b> |
| Cabriolet. Tinted Grey -0.15 <b>\$59.50 EA</b> ⚠                           |              |
| <b>2564ST</b> .....  | <b>41-48</b> |
| Cabriolet. Tinted Green 10.658 -0.15<br><b>\$59.25 EA</b> ⚠                |              |
| <b>2623S</b> .....   | <b>41-48</b> |
| Fleetline 4-door. Clear 10.658 -0.15<br><b>\$28.00 EA</b> ⚠                |              |
| <b>2623SD</b> .....  | <b>41-48</b> |
| Fleetline 4 Door. Tinted Grey -0.15<br><b>\$32.00 EA</b> ⚠                 |              |

## Front Door Vent Glass, cont.

|   |              |
|---|--------------|
| <b>2623ST</b> .....   | <b>41-48</b> |
| Fleetline 4 Door. Tinted Green 10.658 -0.15<br><b>\$28.00 EA</b> ⚠          |              |
| <b>2653S</b> .....  | <b>42-48</b> |
| Fleetline 2-door. Clear 10.658 -0.15<br><b>\$28.00 EA</b> ⚠                 |              |
| <b>2653SD</b> .....   | <b>42-48</b> |
| Fleetline 2 Door. Tinted Grey -0.15<br><b>\$38.00 EA</b> ⚠                  |              |
| <b>2653ST</b> .....   | <b>42-48</b> |
| Fleetline 2 Door. Tinted Green 10.658 -0.15<br><b>\$28.00 EA</b> ⚠          |              |
| <b>2529S</b> .....  | <b>46-48</b> |
| Station Wagon. Clear 10.658 -0.15<br><b>\$57.75 EA</b> ⚠                    |              |
| <b>2529SD</b> .....   | <b>46-48</b> |
| Station Wagon. Tinted Grey -0.15<br><b>\$48.50 EA</b> ⚠                     |              |
| <b>2529ST</b> .....   | <b>46-48</b> |
| Station Wagon. Tinted Green 10.994 -0.15<br><b>\$44.50 EA</b> ⚠             |              |
| <b>2794S</b> .....  | <b>49-52</b> |
| Styleline exc Convertible. Clear 10.658 -0.15<br><b>\$34.00 EA</b> ⚠        |              |
| <b>2794SD</b> .....   | <b>49-52</b> |
| Styleline Exc Convertible. Tinted Grey -0.15<br><b>\$32.00 EA</b> ⚠         |              |
| <b>2794ST</b> .....   | <b>49-52</b> |
| Styleline Exc Convertible. Tinted Green<br>10.658 -0.15 <b>\$34.00 EA</b> ⚠ |              |
| <b>2798S</b> .....  | <b>49-52</b> |
| Fleetline. Clear 10.658 -0.15 <b>\$56.00 EA</b> ⚠                           |              |
| <b>2798SD</b> .....   | <b>49-52</b> |
| Fleetline. Tinted Grey -0.15 <b>\$32.00 EA</b> ⚠                            |              |
| <b>2798ST</b> .....   | <b>49-52</b> |
| Fleetline. Tinted Green 10.658 -0.15<br><b>\$28.00 EA</b> ⚠                 |              |
| <b>2800S</b> .....  | <b>49-52</b> |
| Convertible & Hardtop. Clear 10.658 -0.15<br><b>\$28.00 EA</b> ⚠            |              |
| <b>2800SD</b> .....   | <b>49-52</b> |
| Convertible & Hardtop. Tinted Grey -0.15<br><b>\$32.00 EA</b> ⚠             |              |
| <b>2800ST</b> .....   | <b>49-52</b> |
| Convertible & Hardtop. Tinted Green<br>10.658 -0.15 <b>\$28.00 EA</b> ⚠     |              |
| <b>2984S</b> .....  | <b>53-54</b> |
| Exc Convertible, Hardtop. Clear 10.658 -0.15<br><b>\$34.00 EA</b> ⚠         |              |
| <b>2984SD</b> .....   | <b>53-54</b> |
| Exc Convertible, Hardtop. Tinted<br>Grey -0.15 <b>\$40.00 EA</b> ⚠          |              |
| <b>2984ST</b> .....   | <b>53-54</b> |
| Exc Convertible, Hardtop. Tinted Green<br>10.658 -0.15 <b>\$28.00 EA</b> ⚠  |              |
| <b>2988S</b> .....  | <b>53-54</b> |
| Convertible, Hardtop. Clear 10.658 -0.15<br><b>\$28.00 EA</b> ⚠             |              |
| <b>2988SD</b> .....   | <b>53-54</b> |
| Convertible, Hardtop. Tinted Grey -0.15<br><b>\$32.00 EA</b> ⚠              |              |

Returns require a return authorization number—call first. • Product pricing & availability subject to change.

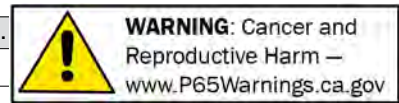

# Section 420C: Glass

## Front Door Vent Glass, cont.

**2988ST**..... **53-54**  
Convertible, Hardtop. Tinted Green  
10.658 -0.15 ..... **\$34.00 EA** ⚠

## Front Door Glass

**3935**.....**37-38**  
Four door & Sedan Delivery. Clear  
10.681 -0.15 ..... **\$32.00 EA** ⚠  
**3935D**.....**37-38**  
Four Door & Sedan Delivery. Tinted  
Grey -0.15 ..... **\$36.00 EA** ⚠  
**3935T**.....**37-38**  
Four Door & Sedan Delivery. Tinted Green  
10.681 -0.15 ..... **\$32.00 EA** ⚠  
**3936**.....**37-38**  
Coupe. Clear 10.681 -0.15 .. **\$44.00 EA**  
⚠  
**3936D**.....**37-38**  
Coupe. Tinted Grey -0.15 **\$50.00 EA**  
⚠  
**3936T**.....**37-38**  
Coupe. Tinted Green 10.681 -0.15 .....  
**\$38.00 EA** ⚠  
**3937**.....**37-38**  
Cabriolet. Clear 10.681 -0.15 .....  
**\$44.00 EA** ⚠  
**3937D**.....**37-38**  
Cabriolet. Tinted Grey -0.15 .....  
**\$50.00 EA** ⚠  
**3937T**.....**37-38**  
Cabriolet. Tinted Green 10.681 -0.15 ..  
**\$44.00 EA** ⚠  
**3939**.....**37-38**  
Two door Sedan. Clear 10.681 -0.15 ...  
**\$48.00 EA** ⚠  
**3939D**.....**37-38**  
Two Door Sedan. Tinted Grey -0.15 ..  
**\$52.00 EA** ⚠  
**3939T**.....**37-38**  
Two Door Sedan. Tinted Green 10.681 -0.15  
..... **\$48.00 EA** ⚠  
**4067**.....**39**  
Four door & Sedan Delivery. Clear  
10.681 -0.15 ..... **\$32.00 EA** ⚠  
**4067D**.....**39**  
Four Door & Sedan Delivery. Tinted  
Grey -0.15 ..... **\$36.00 EA** ⚠  
**4067T**.....**39**  
Four Door & Sedan Delivery. Tinted Green  
10.681 -0.15 ..... **\$38.00 EA** ⚠  
**4068**.....**39**  
Two door Sedan. Clear 10.681 -0.15 ...  
**\$56.00 EA** ⚠  
**4068D**.....**39**  
Two Door Sedan. Tinted Grey -0.15 ..  
**\$52.00 EA** ⚠  
**4068T**.....**39**  
Two Door Sedan. Tinted Green 10.681 -0.15  
..... **\$56.00 EA** ⚠  
**4069**.....**39**  
Coupe. Clear 10.681 -0.15 .. **\$44.00 EA**  
⚠

## Front Door Glass, cont.

**4069D**.....**39**  
Coupe. Tinted Grey -0.15 . **\$50.00 EA**  
⚠  
**4069T**.....**39**  
Coupe. Tinted Green 10.681 -0.15 .....  
**\$38.00 EA** ⚠  
**4030S**.....**40**  
Cabriolet. Clear 10.681 -0.15 .....  
**\$54.00 EA** ⚠  
**4030SD**.....**40**  
Cabriolet. Tinted Grey -0.15 .....  
**\$58.00 EA** ⚠  
**4030ST**.....**40**  
Cabriolet. Tinted Green 10.681 -0.15 ..  
**\$54.00 EA** ⚠  
**4032S**.....**40**  
Two door Sedan. Clear 10.681 -0.15 ...  
**\$54.00 EA** ⚠  
**4032SD**.....**40**  
Two Door Sedan. Tinted Grey -0.15 ..  
**\$58.00 EA** ⚠  
**4032ST**.....**40**  
Two Door Sedan. Tinted Green 10.681 -0.15  
..... **\$54.00 EA** ⚠  
**4033S**.....**40**  
Four door & Sedan Delivery. Clear  
10.681 -0.15 ..... **\$40.00 EA** ⚠  
**4033SD**.....**40**  
Four Door & Sedan Delivery. Tinted  
Grey -0.15 ..... **\$44.00 EA** ⚠  
**4033ST**.....**40**  
Four Door & Sedan Delivery. Tinted Green  
10.681 -0.15 ..... **\$34.00 EA** ⚠  
**4034S**.....**40**  
Coupe. Clear 10.681 -0.15 .. **\$58.00 EA**  
⚠  
**4034SD**.....**40**  
Coupe. Tinted Grey -0.15 . **\$54.00 EA**  
⚠  
**4034ST**.....**40**  
Coupe. Tinted Green 10.681 -0.15 .....  
**\$50.00 EA** ⚠  
**4078S**.....**41**  
Cabriolet. Clear 10.681 -0.15 .....  
**\$98.25 EA** ⚠  
**4078SD**.....**41**  
Cabriolet. Tinted Grey -0.15 .....  
**\$103.75 EA** ⚠  
**4078ST**.....**41**  
Cabriolet. Tinted Green 10.681 -0.15 ..  
**\$103.75 EA** ⚠  
**4158S**.....**41**  
Wagon. Clear 10.681 -0.15 . **\$55.75 EA**  
⚠  
**4158SD**.....**41**  
Wagon. Tinted Grey -0.15 . **\$61.50 EA**  
⚠  
**4158ST**.....**41**  
Wagon. Tinted Green 10.681 -0.15 .....  
**\$49.25 EA** ⚠  
**4079S**.....**41-48**  
Coupe. Clear 10.681 -0.15 .. **\$52.00 EA**  
⚠

## Front Door Glass, cont.

**4079SD**..... **41-48**  
Coupe. Tinted Grey -0.15 . **\$58.00 EA**  
⚠  
**4079ST**..... **41-48**  
Coupe. Tinted Green 10.681 -0.15 .....  
**\$44.00 EA** ⚠  
**4080S**..... **41-48**  
Four Door, Sedan Delivery (exc Fleetline).  
Clear 10.681 -0.15 ..... **\$42.00 EA** ⚠  
**4080SD**..... **41-48**  
Four Door, Sedan Delivery (exc Fleetline).  
Tinted Grey -0.15 ..... **\$40.00 EA** ⚠  
**4080ST**..... **41-48**  
Four Door, Sedan Delivery (exc Fleetline).  
Tinted Green 10.681 -0.15 .. **\$36.00 EA**  
⚠  
**4082S**..... **41-48**  
Two door Sedan. Clear 10.681 -0.15 ...  
**\$56.00 EA** ⚠  
**4082SD**..... **41-48**  
Two Door Sedan. Tinted Grey -0.15 ..  
**\$52.00 EA** ⚠  
**4082ST**..... **41-48**  
Two Door Sedan. Tinted Green 10.681 -0.15  
..... **\$56.00 EA** ⚠  
**4132S**..... **41-48**  
Four door Fleetline. Clear 10.681 -0.15  
..... **\$40.00 EA** ⚠  
**4132SD**..... **41-48**  
Four Door Fleetline. Tinted Grey -0.15  
..... **\$40.00 EA** ⚠  
**4132ST**..... **41-48**  
Four Door Fleetline. Tinted Green  
10.681 -0.15 ..... **\$34.00 EA** ⚠  
**4162S**..... **42**  
Wagon. Clear 10.681 -0.15 . **\$78.50 EA**  
⚠  
**4162SD**..... **42**  
Wagon. Tinted Grey -0.15 . **\$61.50 EA**  
⚠  
**4162ST**..... **42**  
Wagon. Tinted Green 10.681 -0.15 .....  
**\$49.25 EA** ⚠  
**2654S**..... **42-48**  
Two door Fleetline. Clear 10.681 -0.15  
..... **\$58.00 EA** ⚠  
**2654SD**..... **42-48**  
Two Door Fleetline. Tinted Grey -0.15  
..... **\$64.00 EA** ⚠  
**2654ST**..... **42-48**  
Two Door Fleetline. Tinted Green  
10.681 -0.15 ..... **\$50.00 EA** ⚠  
**4166S**..... **42-48**  
Cabriolet. Clear 10.681 -0.15 .....  
**\$98.25 EA** ⚠  
**4166SD**..... **42-48**  
Cabriolet. Tinted Grey -0.15 .....  
**\$104.00 EA** ⚠  
**4166ST**..... **42-48**  
Cabriolet. Tinted Green 10.681 -0.15 ..  
**\$103.75 EA** ⚠  
**4223S**..... **46-48**  
Wagon. Clear 10.681 -0.15 . **\$55.75 EA**  
⚠

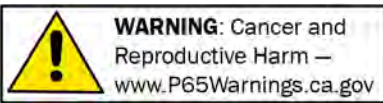

Chemicals shipped domestic ground only (Lower 48 states only). No international shipping.

Phone: (360) 816-0211 • (800) 999-CHEV (2438) • www.chevsofthe40s.com

420C



# Section 420C: Glass

## Front Door Glass, cont.

|  |              |
|--|--------------|
| <b>4279S</b> .....   | <b>49-52</b> |
| Two door Styleline. Clear 10.681 -0.15                         |              |
| <b>\$66.00 EA</b> ⚠  |              |
| <b>4279SD</b> .....  | <b>49-52</b> |
| Two Door Styleline. Tinted Grey -0.15                          |              |
| <b>\$60.00 EA</b> ⚠  |              |
| <b>4279ST</b> .....  | <b>49-52</b> |
| Two Door Styleline. Tinted Green -0.15                         |              |
| <b>\$56.00 EA</b> ⚠  |              |
| <b>4280S</b> .....   | <b>49-52</b> |
| Metal Wagon. Clear 10.681 -0.15                                |              |
| <b>\$48.00 EA</b> ⚠  |              |
| <b>4280SD</b> .....  | <b>49-52</b> |
| Metal Wagon. Tinted Grey -0.15                                 |              |
| <b>\$52.00 EA</b> ⚠  |              |
| <b>4280ST</b> .....  | <b>49-52</b> |
| Metal Wagon. Tinted Green 10.681 -0.15                         |              |
| <b>\$48.00 EA</b> ⚠  |              |
| <b>4284S</b> .....   | <b>49-52</b> |
| Four door Styleline, Sedan Delivery. Clear 10.681 -0.15        |              |
| <b>\$46.00 EA</b> ⚠  |              |
| <b>4284SD</b> .....  | <b>49-52</b> |
| Four Door Styleline, Sedan Delivery. Tinted Grey -0.15         |              |
| <b>\$44.00 EA</b> ⚠  |              |
| <b>4284ST</b> .....  | <b>49-52</b> |
| Four Door Styleline, Sedan Delivery. Tinted Green 10.681 -0.15 |              |
| <b>\$46.00 EA</b> ⚠  |              |
| <b>4285S</b> .....   | <b>49-52</b> |
| Wood Wagon. Clear 10.681 -0.15                                 |              |
| <b>\$63.25 EA</b> ⚠  |              |
| <b>4285SD</b> .....  | <b>49-52</b> |
| Wood Wagon. Tinted Grey -0.15                                  |              |
| <b>\$69.50 EA</b> ⚠  |              |
| <b>4285ST</b> .....  | <b>49-52</b> |
| Wood Wagon. Tinted Green 10.681 -0.15                          |              |
| <b>\$55.75 EA</b> ⚠  |              |
| <b>4287S</b> .....   | <b>49-52</b> |
| Convertible, Hardtop. Clear 10.681 -0.15                       |              |
| <b>\$56.00 EA</b> ⚠  |              |
| <b>4287SD</b> .....  | <b>49-52</b> |
| Convertible, Hardtop. Tinted Grey -0.15                        |              |
| <b>\$60.00 EA</b> ⚠  |              |
| <b>4287ST</b> .....  | <b>49-52</b> |
| Convertible, Hardtop. Tinted Green 10.681 -0.15                |              |
| <b>\$56.00 EA</b> ⚠  |              |
| <b>4288S</b> .....   | <b>49-52</b> |
| Four door Fleetline. Clear 10.681 -0.15                        |              |
| <b>\$46.00 EA</b> ⚠  |              |
| <b>4288SD</b> .....  | <b>49-52</b> |
| Four Door Fleetline. Tinted Grey -0.15                         |              |
| <b>\$44.00 EA</b> ⚠  |              |
| <b>4288ST</b> .....  | <b>49-52</b> |
| Four Door Fleetline. Tinted Green 10.681 -0.15                 |              |
| <b>\$40.00 EA</b> ⚠  |              |
| <b>4289S</b> .....   | <b>49-52</b> |
| Two door Fleetline. Clear 10.681 -0.15                         |              |
| <b>\$56.00 EA</b> ⚠  |              |
| <b>4289SD</b> .....  | <b>49-52</b> |
| Two Door Fleetline. Tinted Grey -0.15                          |              |
| <b>\$60.00 EA</b> ⚠  |              |

## Front Door Glass, cont.

|   |              |
|---|--------------|
| <b>4289ST</b> .....                                   | <b>49-52</b> |
| Two Door Fleetline. Tinted Green 10.681 -0.15         |              |
| <b>\$56.00 EA</b> ⚠                                   |              |
| <b>4291S</b> .....                                    | <b>49-52</b> |
| Coupe. Clear 10.681 -0.15                             |              |
| <b>\$66.00 EA</b> ⚠                                   |              |
| <b>4291SD</b> .....                                   | <b>49-52</b> |
| Coupe. Grey tint -0.15                                |              |
| <b>\$70.00 EA</b> ⚠                                   |              |
| <b>4291ST</b> .....                                   | <b>49-52</b> |
| Coupe. Green tint 10.681 -0.15                        |              |
| <b>\$56.00 EA</b> ⚠                                   |              |
| <b>4444S</b> .....                                    | <b>53-54</b> |
| Four door & Sedan Delivery. Clear 10.681 -0.15        |              |
| <b>\$46.00 EA</b> ⚠                                   |              |
| <b>4444SD</b> .....                                   | <b>53-54</b> |
| Four Door & Sedan Delivery. Tinted Grey -0.15         |              |
| <b>\$44.00 EA</b> ⚠                                   |              |
| <b>4444ST</b> .....                                   | <b>53-54</b> |
| Four Door & Sedan Delivery. Tinted Green 10.681 -0.15 |              |
| <b>\$46.00 EA</b> ⚠                                   |              |
| <b>4445S</b> .....                                    | <b>53-54</b> |
| Convertible, Hardtop. Clear 10.681 -0.15              |              |
| <b>\$56.00 EA</b> ⚠                                   |              |
| <b>4445SD</b> .....                                   | <b>53-54</b> |
| Convertible, Hardtop. Tinted Grey -0.15               |              |
| <b>\$60.00 EA</b> ⚠                                   |              |
| <b>4445ST</b> .....                                   | <b>53-54</b> |
| Convertible, Hardtop. Tinted Green 10.681 -0.15       |              |
| <b>\$68.00 EA</b> ⚠                                   |              |
| <b>4450S</b> .....                                    | <b>53-54</b> |
| Wagon. Clear 10.681 -0.15                             |              |
| <b>\$48.00 EA</b> ⚠                                   |              |
| <b>4450SD</b> .....                                   | <b>53-54</b> |
| Wagon. Tinted Grey -0.15                              |              |
| <b>\$52.00 EA</b> ⚠                                   |              |
| <b>4450ST</b> .....                                   | <b>53-54</b> |
| Wagon. Tinted Green 10.681 -0.15                      |              |
| <b>\$48.00 EA</b> ⚠                                   |              |
| <b>4452S</b> .....                                    | <b>53-54</b> |
| Two door, Coupe. Clear 10.681 -0.15                   |              |
| <b>\$56.00 EA</b> ⚠                                   |              |
| <b>4452SD</b> .....                                   | <b>53-54</b> |
| Two Door, Coupe. Tinted Grey -0.15                    |              |
| <b>\$70.00 EA</b> ⚠                                   |              |
| <b>4452ST</b> .....                                   | <b>53-54</b> |
| Two Door, Coupe. Tinted Green 10.681 -0.15            |              |
| <b>\$56.00 EA</b> ⚠                                   |              |

## Rear Door Glass

|   |              |
|---|--------------|
| <b>3940</b> .....                       | <b>37-38</b> |
| Master. Clear 10.741 -0.15              |              |
| <b>\$52.00 EA</b> ⚠                     |              |
| <b>3940D</b> .....                      | <b>37-38</b> |
| Master. Tinted Grey 11.204 -0.15        |              |
| <b>\$50.00 EA</b> ⚠                     |              |
| <b>3940T</b> .....                      | <b>37-38</b> |
| Master. Tinted Green 10.741 -0.15       |              |
| <b>\$44.00 EA</b> ⚠                     |              |
| <b>4015</b> .....                       | <b>37-38</b> |
| Master Deluxe. Clear 10.741 -0.15       |              |
| <b>\$44.00 EA</b> ⚠                     |              |
| <b>4015D</b> .....                      | <b>37-38</b> |
| Master Deluxe. Tinted Grey 11.204 -0.15 |              |
| <b>\$50.00 EA</b> ⚠                     |              |

## Rear Door Glass, cont.

|   |              |
|---|--------------|
| <b>4015T</b> .....                          | <b>37-38</b> |
| Master Deluxe. Tinted Green 10.741 -0.15    |              |
| <b>\$44.00 EA</b> ⚠                         |              |
| <b>4071</b> .....                           | <b>39</b>    |
| Clear 10.741 -0.15                          |              |
| <b>\$60.00 EA</b> ⚠                         |              |
| <b>4071D</b> .....                          | <b>39</b>    |
| Tinted Grey 11.204 -0.15                    |              |
| <b>\$64.00 EA</b> ⚠                         |              |
| <b>4071T</b> .....                          | <b>39</b>    |
| Tinted Green 10.741 -0.15                   |              |
| <b>\$60.00 EA</b> ⚠                         |              |
| <b>4031S</b> .....                          | <b>40</b>    |
| Clear 10.741 -0.15                          |              |
| <b>\$64.00 EA</b> ⚠                         |              |
| <b>4031SD</b> .....                         | <b>40</b>    |
| Tinted Grey 11.204 -0.15                    |              |
| <b>\$58.00 EA</b> ⚠                         |              |
| <b>4031ST</b> .....                         | <b>40</b>    |
| Tinted Green 10.741 -0.15                   |              |
| <b>\$54.00 EA</b> ⚠                         |              |
| <b>4159S</b> .....                          | <b>41</b>    |
| Wagon. Clear 10.741 -0.15                   |              |
| <b>\$69.75 EA</b> ⚠                         |              |
| <b>4159SD</b> .....                         | <b>41</b>    |
| Wagon. Tinted Grey 11.204 -0.15             |              |
| <b>\$74.00 EA</b> ⚠                         |              |
| <b>4159ST</b> .....                         | <b>41</b>    |
| Wagon. Tinted Green 10.741 -0.15            |              |
| <b>\$92.00 EA</b> ⚠                         |              |
| <b>4081S</b> .....                          | <b>41-48</b> |
| Except Fleetline. Clear 10.741 -0.15        |              |
| <b>\$44.00 EA</b> ⚠                         |              |
| <b>4081SD</b> .....                         | <b>41-48</b> |
| Except Fleetline. Tinted Grey 11.204 -0.15  |              |
| <b>\$50.00 EA</b> ⚠                         |              |
| <b>4081ST</b> .....                         | <b>41-48</b> |
| Except Fleetline. Tinted Green 10.741 -0.15 |              |
| <b>\$44.00 EA</b> ⚠                         |              |
| <b>4131S</b> .....                          | <b>41-48</b> |
| Fleetline. Clear 10.741 -0.15               |              |
| <b>\$34.00 EA</b> ⚠                         |              |
| <b>4131SD</b> .....                         | <b>41-48</b> |
| Fleetline. Tinted Grey -0.15                |              |
| <b>\$38.00 EA</b> ⚠                         |              |
| <b>4131ST</b> .....                         | <b>41-48</b> |
| Fleetline. Tinted Green 10.741 -0.15        |              |
| <b>\$34.00 EA</b> ⚠                         |              |
| <b>4163S</b> .....                          | <b>42</b>    |
| Wagon. Clear 10.741 -0.15                   |              |
| <b>\$69.75 EA</b> ⚠                         |              |
| <b>4163SD</b> .....                         | <b>42</b>    |
| Wagon. Tinted Grey 11.204 -0.15             |              |
| <b>\$92.00 EA</b> ⚠                         |              |
| <b>4163ST</b> .....                         | <b>42</b>    |
| Wagon. Tinted Green 10.741 -0.15            |              |
| <b>\$73.75 EA</b> ⚠                         |              |
| <b>4224S</b> .....                          | <b>46-48</b> |
| Wagon. Clear 10.741 -0.15                   |              |
| <b>\$100.00 EA</b> ⚠                        |              |
| <b>4224SD</b> .....                         | <b>46-48</b> |
| Wagon. Tinted Grey 11.204 -0.15             |              |
| <b>\$92.00 EA</b> ⚠                         |              |
| <b>4292S</b> .....                          | <b>49</b>    |
| Wood Wagon. Clear 10.741 -0.15              |              |
| <b>\$90.25 EA</b> ⚠                         |              |

Returns require a return authorization number—call first. • Product pricing & availability subject to change.

232 Phone: (360) 816-0211 • (800) 999-CHEV (2438) • www.chevsofthe40s.com

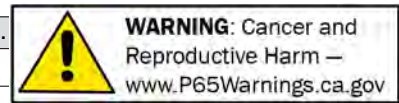

**Rear Door Glass, cont.**

|  |              |
|--|--------------|
| <b>4275S</b> .....                     | <b>49-52</b> |
| Metal Wagon. Clear 10.741 -0.15        |              |
| <b>\$78.00 EA</b> ⚠                    |              |
| <b>4275SD</b> .....                    | <b>49-52</b> |
| Metal Wagon. Tinted Grey 11.204 -0.15  |              |
| <b>\$82.00 EA</b> ⚠                    |              |
| <b>4275ST</b> .....                    | <b>49-52</b> |
| Metal Wagon. Tinted Green 10.741 -0.15 |              |
| <b>\$78.00 EA</b> ⚠                    |              |
| <b>4286S</b> .....                     | <b>49-52</b> |
| Styleline 10.741 -0.15                 |              |
| <b>\$40.00 EA</b> ⚠                    |              |
| <b>4286SD</b> .....                    | <b>49-52</b> |
| Styleline. Grey tint 11.204 -0.15      |              |
| <b>\$44.00 EA</b> ⚠                    |              |
| <b>4286ST</b> .....                    | <b>49-52</b> |
| Styleline. Green tint 10.741 -0.15     |              |
| <b>\$40.00 EA</b> ⚠                    |              |
| <b>4290S</b> .....                     | <b>49-52</b> |
| Fleetline. Clear 10.741 -0.15          |              |
| <b>\$48.00 EA</b> ⚠                    |              |
| <b>4290SD</b> .....                    | <b>49-52</b> |
| Fleetline. Tinted Grey 11.204 -0.15    |              |
| <b>\$52.00 EA</b> ⚠                    |              |
| <b>4290ST</b> .....                    | <b>49-52</b> |
| Fleetline. Tinted Green 10.741 -0.15   |              |
| <b>\$48.00 EA</b> ⚠                    |              |
| <b>4449S</b> .....                     | <b>53-54</b> |
| Four door Clear 10.741 -0.15           |              |
| <b>\$58.00 EA</b> ⚠                    |              |
| <b>4449SD</b> .....                    | <b>53-54</b> |
| Grey -0.15                             |              |
| <b>\$62.00 EA</b> ⚠                    |              |
| <b>4449ST</b> .....                    | <b>53-54</b> |
| Green Tint -0.15                       |              |
| <b>\$58.00 EA</b> ⚠                    |              |
| <b>4453S</b> .....                     | <b>53-54</b> |
| Wagon. Clear 10.741 -0.15              |              |
| <b>\$72.00 EA</b> ⚠                    |              |
| <b>4453SD</b> .....                    | <b>53-54</b> |
| Wagon. Tinted Grey 11.204 -0.15        |              |
| <b>\$76.00 EA</b> ⚠                    |              |
| <b>4453ST</b> .....                    | <b>53-54</b> |
| Wagon. Tinted Green 10.741 -0.15       |              |
| <b>\$72.00 EA</b> ⚠                    |              |

**Rear Door Vent Glass**

|                                       |              |
|---------------------------------------|--------------|
| <b>2624S</b> .....                    | <b>41-48</b> |
| Fleetline. Clear 10.741 -0.15         |              |
| <b>\$34.00 EA</b> ⚠                   |              |
| <b>2624SD</b> .....                   | <b>41-48</b> |
| Fleetline. Tinted Grey 10.827 -0.15   |              |
| <b>\$32.00 EA</b> ⚠                   |              |
| <b>2624ST</b> .....                   | <b>41-48</b> |
| Fleetline. Tinted Green 10.827 -0.15  |              |
| <b>\$28.00 EA</b> ⚠                   |              |
| <b>4221S</b> .....                    | <b>46-48</b> |
| Wagon. Clear 10.827 -0.15             |              |
| <b>\$82.50 EA</b> ⚠                   |              |
| <b>4221SD</b> .....                   | <b>46-48</b> |
| Wagon. Tinted Grey 10.827 -0.15       |              |
| <b>\$93.75 EA</b> ⚠                   |              |
| <b>4221ST</b> .....                   | <b>46-48</b> |
| Wagon. Tinted Green 10.827 -0.15      |              |
| <b>\$82.50 EA</b> ⚠                   |              |
| <b>2790S</b> .....                    | <b>49-52</b> |
| Styleline Special. Clear 10.827 -0.15 |              |
| <b>\$30.00 EA</b> ⚠                   |              |

**Rear Door Vent Glass, cont.**

|  |              |
|--|--------------|
| <b>2790SD</b> .....                          | <b>49-52</b> |
| Styleline Special. Tinted Grey 10.827 -0.15  |              |
| <b>\$34.00 EA</b> ⚠                          |              |
| <b>2790ST</b> .....                          | <b>49-52</b> |
| Styleline Special. Tinted Green 10.827 -0.15 |              |
| <b>\$30.00 EA</b> ⚠                          |              |
| <b>2791S</b> .....                           | <b>49-52</b> |
| Fleetline Special. Clear 10.827 -0.15        |              |
| <b>\$34.00 EA</b> ⚠                          |              |
| <b>2791SD</b> .....                          | <b>49-52</b> |
| Fleetline Special. Tinted Grey 10.827 -0.15  |              |
| <b>\$32.00 EA</b> ⚠                          |              |
| <b>2791ST</b> .....                          | <b>49-52</b> |
| Fleetline Special. Tinted Green 10.827 -0.15 |              |
| <b>\$28.00 EA</b> ⚠                          |              |
| <b>2796S</b> .....                           | <b>49-52</b> |
| Styleline Deluxe. Clear 10.827 -0.15         |              |
| <b>\$34.00 EA</b> ⚠                          |              |
| <b>2796SD</b> .....                          | <b>49-52</b> |
| Styleline Deluxe. Tinted Grey 10.827 -0.15   |              |
| <b>\$32.00 EA</b> ⚠                          |              |
| <b>2796ST</b> .....                          | <b>49-52</b> |
| Styleline Deluxe. Tinted Green 10.827 -0.15  |              |
| <b>\$28.00 EA</b> ⚠                          |              |
| <b>2799S</b> .....                           | <b>49-52</b> |
| Fleetline Deluxe. Clear 10.827 -0.15         |              |
| <b>\$28.00 EA</b> ⚠                          |              |
| <b>2799SD</b> .....                          | <b>49-52</b> |
| Fleetline Deluxe. Tinted Grey 10.827 -0.15   |              |
| <b>\$32.00 EA</b> ⚠                          |              |
| <b>2799ST</b> .....                          | <b>49-52</b> |
| Fleetline Deluxe. Tinted Green 10.827 -0.15  |              |
| <b>\$28.00 EA</b> ⚠                          |              |

**Quarter Glass**

|  |              |
|--|--------------|
| <b>2715</b> .....                                      | <b>37-38</b> |
| Master 4-door. Clear 11.011 -0.15                      |              |
| <b>\$32.00 EA</b> ⚠                                    |              |
| <b>2715D</b> .....                                     | <b>37-38</b> |
| Master 4 Door. Tinted Grey -0.15                       |              |
| <b>\$36.00 EA</b> ⚠                                    |              |
| <b>2715T</b> .....                                     | <b>37-38</b> |
| Master 4 Door. Tinted Green 11.011 -0.15               |              |
| <b>\$32.00 EA</b> ⚠                                    |              |
| <b>2716</b> .....                                      | <b>37-38</b> |
| Coupe. Clear 11.011 -0.15                              |              |
| <b>\$36.00 EA</b> ⚠                                    |              |
| <b>2716D</b> .....                                     | <b>37-38</b> |
| Coupe. Tinted Grey 11.011 -0.15                        |              |
| <b>\$42.00 EA</b> ⚠                                    |              |
| <b>2716T</b> .....                                     | <b>37-38</b> |
| Coupe. Tinted Green 11.011 -0.15                       |              |
| <b>\$30.00 EA</b> ⚠                                    |              |
| <b>2718</b> .....                                      | <b>37-38</b> |
| 4-door Master Deluxe (opens) Clear 11.011 -0.15        |              |
| <b>\$32.00 EA</b> ⚠                                    |              |
| <b>2718D</b> .....                                     | <b>37-38</b> |
| 4-door Master Deluxe (opens). Tinted Grey 11.011 -0.15 |              |
| <b>\$36.00 EA</b> ⚠                                    |              |
| <b>2718T</b> .....                                     | <b>37-38</b> |
| 4-door Master Deluxe (opens) Tinted Green 11.011 -0.15 |              |
| <b>\$32.00 EA</b> ⚠                                    |              |

**Quarter Glass, cont.**

|   |              |
|---|--------------|
| <b>3938</b> .....   | <b>37-38</b> |
| Two door Sedan. Clear 11.011 -0.15                        |              |
| <b>\$60.00 EA</b> ⚠                                       |              |
| <b>3938D</b> .....  | <b>37-38</b> |
| Two Door Sedan. Tinted Grey 11.011 -0.15                  |              |
| <b>\$64.00 EA</b> ⚠                                       |              |
| <b>3938T</b> .....  | <b>37-38</b> |
| Two Door Sedan. Tinted Green 11.011 -0.15                 |              |
| <b>\$60.00 EA</b> ⚠                                       |              |
| <b>2834</b> .....   | <b>39</b>    |
| 5-passenger Coupe (sliding) Clear 10.994 -0.15            |              |
| <b>\$34.00 EA</b> ⚠                                       |              |
| <b>2834D</b> .....  | <b>39</b>    |
| 5-passenger Coupe (sliding). Tinted Grey 11.011 -0.15     |              |
| <b>\$38.00 EA</b> ⚠                                       |              |
| <b>2834T</b> .....  | <b>39</b>    |
| 5-passenger Coupe (sliding). Tinted Green 11.011 -0.15    |              |
| <b>\$34.00 EA</b> ⚠                                       |              |
| <b>2835</b> .....   | <b>39</b>    |
| 3-passenger Coupe (stationary) Clear 10.994 -0.15         |              |
| <b>\$32.00 EA</b> ⚠                                       |              |
| <b>2835D</b> .....  | <b>39</b>    |
| 3-passenger Coupe (stationary). Tinted grey 11.011 -0.15  |              |
| <b>\$36.00 EA</b> ⚠                                       |              |
| <b>2835T</b> .....  | <b>39</b>    |
| 3-passenger Coupe (stationary). Tinted Green 11.011 -0.15 |              |
| <b>\$32.00 EA</b> ⚠                                       |              |
| <b>2836</b> .....   | <b>39</b>    |
| 4 Door (opens) Master Deluxe. Clear 10.994 -0.15          |              |
| <b>\$34.00 EA</b> ⚠                                       |              |
| <b>2836D</b> .....  | <b>39</b>    |
| 4 Door (opens) Master Deluxe. Tinted Grey 11.011 -0.15    |              |
| <b>\$38.00 EA</b> ⚠                                       |              |
| <b>2836T</b> .....  | <b>39</b>    |
| 4 Door (opens) Master Deluxe. Tinted Green 11.011 -0.15   |              |
| <b>\$40.00 EA</b> ⚠                                       |              |
| <b>2837</b> .....   | <b>39</b>    |
| Four door Master. Clear 11.011 -0.15                      |              |
| <b>\$32.00 EA</b> ⚠                                       |              |
| <b>2837D</b> .....  | <b>39</b>    |
| Four door Master. Tinted Grey 11.011 -0.15                |              |
| <b>\$36.00 EA</b> ⚠                                       |              |
| <b>2837T</b> .....  | <b>39</b>    |
| Four door Master. Tinted Green 11.011 -0.15               |              |
| <b>\$32.00 EA</b> ⚠                                       |              |
| <b>4070</b> .....   | <b>39</b>    |
| Two door Sedan. Clear 11.011 -0.15                        |              |
| <b>\$74.00 EA</b> ⚠                                       |              |
| <b>4070D</b> .....  | <b>39</b>    |
| Two Door Sedan. Tinted Grey 11.011 -0.15                  |              |
| <b>\$66.00 EA</b> ⚠                                       |              |
| <b>4070T</b> .....  | <b>39</b>    |
| Two Door Sedan. Tinted Green 11.011 -0.15                 |              |
| <b>\$74.00 EA</b> ⚠                                       |              |
| <b>1008S</b> .....  | <b>40</b>    |
| 2-door Sedan. Clear 11.011 -0.15                          |              |
| <b>\$88.00 EA</b> ⚠                                       |              |
| <b>1008SD</b> .....                                       | <b>40</b>    |
| 2 door Sedan. Tinted Grey 11.011 -0.15                    |              |
| <b>\$80.00 EA</b> ⚠                                       |              |
| <b>1008ST</b> .....                                       | <b>40</b>    |
| 2 door Sedan. Tinted Green 11.011 -0.15                   |              |
| <b>\$76.00 EA</b> ⚠                                       |              |

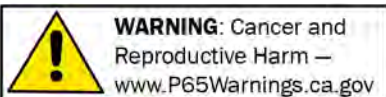

Chemicals shipped domestic ground only (Lower 48 states only). No international shipping.

**Phone: (360) 816-0211 • (800) 999-CHEV (2438) • www.chevsofthe40s.com**



# Section 420C: Glass

## Quarter Glass, cont.

|  |              |
|--|--------------|
| <b>2526S</b> .....   | <b>40</b>    |
| 4-door Master & 3 pass Coupe (stationary) Clear 11.011 -0.15 .....     |              |
| <b>\$38.00 EA</b> ⚠  |              |
| <b>2526SD</b> .....  | <b>40</b>    |
| 4-door Master & 3 pass Coupe (stationary). Tinted Grey 11.011 -0.15 .. |              |
| <b>\$42.00 EA</b> ⚠  |              |
| <b>2526ST</b> .....  | <b>40</b>    |
| 4-door Master & 3 pass Coupe (stationary). Tinted Green 11.011 -0.15   |              |
| <b>\$38.00 EA</b> ⚠  |              |
| <b>2527S</b> .....   | <b>40</b>    |
| 4-door & 5 pass Coupe (sliding) Clear 10.994 -0.15 .....               |              |
| <b>\$44.00 EA</b> ⚠  |              |
| <b>2527SD</b> .....  | <b>40</b>    |
| 4-door & 5 pass Coupe (sliding). Tinted Grey 11.011 -0.15 .....        |              |
| <b>\$42.00 EA</b> ⚠  |              |
| <b>2527ST</b> .....  | <b>40</b>    |
| 4-door & 5 pass Coupe (sliding). Tinted Green 11.011 -0.15 .....       |              |
| <b>\$38.00 EA</b> ⚠  |              |
| <b>4160S</b> .....   | <b>41</b>    |
| (Opens) Wagon. Clear 10.994 -0.15 .....                                |              |
| <b>\$106.00 EA</b> ⚠   |              |
| <b>4160SD</b> .....  | <b>41</b>    |
| (Opens) Wagon. Tinted Grey 11.011 -0.15 .....                          |              |
| <b>\$74.00 EA</b> ⚠  |              |
| <b>4160ST</b> .....  | <b>41</b>    |
| (Opens) Wagon. Tinted Green 11.011 -0.15 .....                         |              |
| <b>\$92.00 EA</b> ⚠  |              |
| <b>4161S</b> .....   | <b>41</b>    |
| Wagon. Clear 11.011 -0.15 ..   |              |
| <b>\$70.00 EA</b> ⚠  |              |
| <b>4161SD</b> .....  | <b>41</b>    |
| Wagon. Tinted Grey 11.011 -0.15 .....                                  |              |
| <b>\$92.00 EA</b> ⚠  |              |
| <b>4161ST</b> .....  | <b>41</b>    |
| Wagon. Tinted Green 11.011 -0.15 .....                                 |              |
| <b>\$73.75 EA</b> ⚠  |              |
| <b>2566S</b> .....   | <b>41-48</b> |
| 3 pass Coupe (stationary). Clear 11.011 -0.15 .....                    |              |
| <b>\$34.00 EA</b> ⚠  |              |
| <b>2566SD</b> .....  | <b>41-48</b> |
| 3 pass Coupe (stationary). Tinted Grey 11.011 -0.15 .....              |              |
| <b>\$38.00 EA</b> ⚠  |              |
| <b>2566ST</b> .....  | <b>41-48</b> |
| 3 pass Coupe (stationary). Tinted Green 11.011 -0.15 .....             |              |
| <b>\$34.00 EA</b> ⚠  |              |
| <b>2567S</b> .....   | <b>41-48</b> |
| 5 passenger Coupe (sliding). Clear 10.994 -0.15 .....                  |              |
| <b>\$46.00 EA</b> ⚠  |              |
| <b>2567SD</b> .....  | <b>41-48</b> |
| 5 passenger Coupe (sliding). Tinted Grey 11.011 -0.15 .....            |              |
| <b>\$44.00 EA</b> ⚠  |              |
| <b>2567ST</b> .....  | <b>41-48</b> |
| 5 passenger Coupe (sliding). Tinted Green 11.011 -0.15 .....           |              |
| <b>\$40.00 EA</b> ⚠  |              |
| <b>2568S</b> .....   | <b>41-48</b> |
| 4 door (sliding). Clear 10.994 -0.15 .....                             |              |
| <b>\$44.00 EA</b> ⚠  |              |
| <b>2568SD</b> .....  | <b>41-48</b> |
| 4 door (sliding). Tinted Grey 11.011 -0.15 .....                       |              |
| <b>\$42.00 EA</b> ⚠  |              |

## Quarter Glass, cont.

|   |              |
|---|--------------|
| <b>2568ST</b> .....   | <b>41-48</b> |
| 4 door (sliding). Tinted Green 11.011 -0.15 .....           |              |
| <b>\$38.00 EA</b> ⚠   |              |
| <b>2569S</b> .....  | <b>41-48</b> |
| 4-door, stationary. Clear 11.011 -0.15 ..                   |              |
| <b>\$38.00 EA</b> ⚠   |              |
| <b>2569SD</b> .....   | <b>41-48</b> |
| 4 Door (stationary). Tinted Grey 11.011 -0.15 .....         |              |
| <b>\$42.00 EA</b> ⚠   |              |
| <b>2569ST</b> .....   | <b>41-48</b> |
| 4 Door (stationary). Tinted Green 11.011 -0.15 .....        |              |
| <b>\$38.00 EA</b> ⚠   |              |
| <b>4083S</b> .....  | <b>41-48</b> |
| 2-door sedan exc Fleetline. Clear 11.011 -0.15 .....        |              |
| <b>\$56.00 EA</b> ⚠   |              |
| <b>4083SD</b> .....   | <b>41-48</b> |
| 2 Door Sedan exc Fleetline. Tinted Grey 11.011 -0.15 .....  |              |
| <b>\$60.00 EA</b> ⚠   |              |
| <b>4083ST</b> .....   | <b>41-48</b> |
| 2 Door Sedan exc Fleetline. Tinted Green 11.011 -0.15 ..... |              |
| <b>\$66.00 EA</b> ⚠   |              |
| <b>4164S</b> .....  | <b>42</b>    |
| (Opens) Wagon. Clear 10.994 -0.15 .....                     |              |
| <b>\$76.50 EA</b> ⚠   |              |
| <b>4164SD</b> .....   | <b>42</b>    |
| (opens) Wagon. Tinted Grey 11.011 -0.15 .....               |              |
| <b>\$101.25 EA</b> ⚠  |              |
| <b>4164ST</b> .....   | <b>42</b>    |
| (opens) Wagon. Tinted Green 11.011 -0.15 .....              |              |
| <b>\$81.00 EA</b> ⚠   |              |
| <b>4165S</b> .....  | <b>42</b>    |
| Wagon. Clear 11.011 -0.15 ..                                |              |
| <b>\$70.00 EA</b> ⚠   |              |
| <b>4165SD</b> .....   | <b>42</b>    |
| Wagon. Tinted Grey 11.011 -0.15 .....                       |              |
| <b>\$92.00 EA</b> ⚠   |              |
| <b>4165ST</b> .....   | <b>42</b>    |
| Wagon. Tinted Green 11.011 -0.15 .....                      |              |
| <b>\$73.75 EA</b> ⚠   |              |
| <b>2655S</b> .....  | <b>42-48</b> |
| Fleetline 2-door. Clear 11.011 -0.15 .....                  |              |
| <b>\$54.00 EA</b> ⚠   |              |
| <b>2655SD</b> .....   | <b>42-48</b> |
| Fleetline 2 Door. Tinted Grey 11.011 -0.15 .....            |              |
| <b>\$68.00 EA</b> ⚠   |              |
| <b>2655ST</b> .....   | <b>42-48</b> |
| Fleetline 2 Door. Tinted Green 11.011 -0.15 .....           |              |
| <b>\$64.00 EA</b> ⚠   |              |
| <b>2656S</b> .....  | <b>42-48</b> |
| Cabriolet. Clear 11.011 -0.15 .....                         |              |
| <b>\$68.25 EA</b> ⚠   |              |
| <b>2656SD</b> .....   | <b>42-48</b> |
| Cabriolet. Tinted Grey 11.011 -0.15 .....                   |              |
| <b>\$71.50 EA</b> ⚠   |              |
| <b>2656ST</b> .....   | <b>42-48</b> |
| Cabriolet. Tinted Green 11.011 -0.15 .....                  |              |
| <b>\$71.50 EA</b> ⚠   |              |
| <b>4222S</b> .....  | <b>46-48</b> |
| Wagon. Clear 11.011 -0.15 ..                                |              |
| <b>\$82.50 EA</b> ⚠   |              |
| <b>4222SD</b> .....   | <b>46-48</b> |
| Wagon. Tinted Grey 11.011 -0.15 .....                       |              |
| <b>\$93.75 EA</b> ⚠   |              |

## Quarter Glass, cont.

|   |              |
|---|--------------|
| <b>4222ST</b> .....   | <b>46-48</b> |
| Wagon. Tinted Green 11.011 -0.15 .....                                |              |
| <b>\$82.50 EA</b> ⚠   |              |
| <b>4281S</b> .....  | <b>49</b>    |
| Vent-wood Wagon. Clear 10.994 -0.15 ..                                |              |
| <b>\$63.25 EA</b> ⚠   |              |
| <b>4281SD</b> .....   | <b>49</b>    |
| Vent-wood Wagon. Tinted Grey 11.011 -0.15 .....                       |              |
| <b>\$69.50 EA</b> ⚠   |              |
| <b>4281ST</b> .....   | <b>49</b>    |
| Vent-wood Wagon. Tinted Green 11.011 -0.15 .....                      |              |
| <b>\$63.25 EA</b> ⚠   |              |
| <b>2793S</b> .....  | <b>49-52</b> |
| Styleline Special, 3-passenger Coupe. Clear 11.011 -0.15 .....        |              |
| <b>\$40.00 EA</b> ⚠   |              |
| <b>2793SD</b> .....   | <b>49-52</b> |
| Styleline Special, 3 Passenger Coupe. Tinted Grey 11.011 -0.15 ..     |              |
| <b>\$38.00 EA</b> ⚠   |              |
| <b>2793ST</b> .....   | <b>49-52</b> |
| Styleline Special, 3 Passenger Coupe. Tinted Green 11.011 -0.15 ..... |              |
| <b>\$34.00 EA</b> ⚠   |              |
| <b>2795S</b> .....  | <b>49-52</b> |
| Convertible & Hardtop. Clear 11.011 -0.15 .....                       |              |
| <b>\$38.00 EA</b> ⚠   |              |
| <b>2795SD</b> .....   | <b>49-52</b> |
| Convertible & Hardtop. Tinted Grey 11.011 -0.15 .....                 |              |
| <b>\$42.00 EA</b> ⚠   |              |
| <b>2795ST</b> .....   | <b>49-52</b> |
| Convertible & Hardtop. Tinted Green 11.011 -0.15 .....                |              |
| <b>\$44.00 EA</b> ⚠   |              |
| <b>2797S</b> .....  | <b>49-52</b> |
| Fleetline 2-door. Clear 11.011 -0.15 .....                            |              |
| <b>\$56.00 EA</b> ⚠   |              |
| <b>2797SD</b> .....   | <b>49-52</b> |
| Fleetline 2 Door. Tinted Grey 11.011 -0.15 .....                      |              |
| <b>\$60.00 EA</b> ⚠   |              |
| <b>2797ST</b> .....   | <b>49-52</b> |
| Fleetline 2 Door. Tinted Green 11.011 -0.15 .....                     |              |
| <b>\$56.00 EA</b> ⚠   |              |
| <b>4276S</b> .....  | <b>49-52</b> |
| Metal, wagon. Clear 11.011 -0.15 .....                                |              |
| <b>\$36.00 EA</b> ⚠   |              |
| <b>4276SD</b> .....   | <b>49-52</b> |
| Metal Wagon. Tinted Grey 11.011 -0.15 .....                           |              |
| <b>\$40.00 EA</b> ⚠   |              |
| <b>4276ST</b> .....   | <b>49-52</b> |
| Metal Wagon. Tinted Green 11.011 -0.15 .....                          |              |
| <b>\$36.00 EA</b> ⚠   |              |
| <b>4277S</b> .....  | <b>49-52</b> |
| Styleline 2-door. Clear 11.011 -0.15 .....                            |              |
| <b>\$68.00 EA</b> ⚠   |              |
| <b>4277SD</b> .....   | <b>49-52</b> |
| Styleline 2 Door. Tinted Grey 11.011 -0.15 .....                      |              |
| <b>\$62.00 EA</b> ⚠   |              |
| <b>4277ST</b> .....   | <b>49-52</b> |
| Styleline 2 Door. Tinted Green 11.011 -0.15 .....                     |              |
| <b>\$58.00 EA</b> ⚠   |              |
| <b>4278S</b> .....  | <b>49-52</b> |
| Vent-metal Wagon. Clear 10.994 -0.15 ..                               |              |
| <b>\$36.00 EA</b> ⚠   |              |

Returns require a return authorization number—call first. • Product pricing & availability subject to change.



**WARNING:** Cancer and Reproductive Harm — www.P65Warnings.ca.gov

# Section 420C: Glass

## Quarter Glass, cont.

|  |                      |
|--|----------------------|
| <b>4278SD</b> .....                          | <b>49-52</b>         |
| Vent-metal Wagon. Tinted Grey 11.011 -0.15   |                      |
| .....  | <b>\$40.00 EA</b> ⚠  |
| <b>4278ST</b> .....                          | <b>49-52</b>         |
| Vent-metal Wagon. Tinted Green               |                      |
| 11.011 -0.15 .....                           | <b>\$36.00 EA</b> ⚠  |
| <b>4283S</b> .....                           | <b>49-52</b>         |
| Styleline Special, 6 Passenger Coupe.        |                      |
| Clear 11.011 -0.15 .....                     | <b>\$34.00 EA</b> ⚠  |
| <b>4283SD</b> .....                          | <b>49-52</b>         |
| Styleline Special, 6 Passenger Coupe.        |                      |
| Tinted Grey -0.15 .....                      | <b>\$38.00 EA</b> ⚠  |
| <b>4283ST</b> .....                          | <b>49-52</b>         |
| Styleline Special, 6 Passenger Coupe.        |                      |
| Tinted Green -0.15 .....                     | <b>\$34.00 EA</b> ⚠  |
| <b>2982S</b> .....                           | <b>53</b>            |
| Coupe. Clear 11.011-0.15 .....               | <b>\$50.00 EA</b> ⚠  |
| <b>2982SD</b> .....                          | <b>53</b>            |
| Coupe. Tinted Grey 11.011 -0.15 .....        | <b>\$54.00 EA</b> ⚠  |
| <b>2982ST</b> .....                          | <b>53</b>            |
| Coupe. Tinted Green 11.011-0.15 .....        | <b>\$50.00 EA</b> ⚠  |
| <b>2983S</b> .....                           | <b>53-54</b>         |
| Hardtop. Clear 11.011 -0.15 .....            | <b>\$40.00 EA</b> ⚠  |
| <b>2983SD</b> .....                          | <b>53-54</b>         |
| Hardtop. Tinted Grey 11.011 -0.15 .....      | <b>\$52.00 EA</b> ⚠  |
| <b>2983ST</b> .....                          | <b>53-54</b>         |
| Hardtop. Tinted Green 11.011-0.15 .....      | <b>\$46.00 EA</b> ⚠  |
| <b>2985S</b> .....                           | <b>53-54</b>         |
| Convertible. Clear 11.011-0.15 .....         | <b>\$34.00 EA</b> ⚠  |
| <b>2985SD</b> .....                          | <b>53-54</b>         |
| Convertible. Tinted Grey 11.011 -0.15 .....  | <b>\$38.00 EA</b> ⚠  |
| <b>2985ST</b> .....                          | <b>53-54</b>         |
| Convertible. Tinted Green 11.011 -0.15 ..... | <b>\$34.00 EA</b> ⚠  |
| <b>4443S</b> .....                           | <b>53-54</b>         |
| Wagon stationary (6 passenger) Clear         |                      |
| 11.011 -0.15 .....                           | <b>\$98.00 EA</b> ⚠  |
| <b>4443SD</b> .....                          | <b>53-54</b>         |
| Wagon stationary (6 passenger) Tinted        |                      |
| Grey 11.011 -0.15 .....                      | <b>\$109.75 EA</b> ⚠ |
| <b>4443ST</b> .....                          | <b>53-54</b>         |
| Wagon stationary (6 passenger) Tinted        |                      |
| Green 11.011 -0.15 .....                     | <b>\$87.75 EA</b> ⚠  |
| <b>4446S</b> .....                           | <b>53-54</b>         |
| Wagon (Stationary) fits 8 passenger. Clear   |                      |
| 11.011 -0.15 .....                           | <b>\$64.00 EA</b> ⚠  |
| <b>4446SD</b> .....                          | <b>53-54</b>         |
| Wagon (Stationary)(fits 8 passenger)         |                      |
| Tinted Grey 11.011 -0.15 .....               | <b>\$69.50 EA</b> ⚠  |
| <b>4446ST</b> .....                          | <b>53-54</b>         |
| Wagon (Stationary)(fits 8 passenger)         |                      |
| Tinted Green 11.011 -0.15 .....              | <b>\$63.25 EA</b> ⚠  |

## Quarter Glass, cont.

|   |                     |
|---|---------------------|
| <b>4447S</b> .....                            | <b>53-54</b>        |
| Wagon (Sliding) fits 8 passenger. Clear       |                     |
| 10.994 -0.15 .....                            | <b>\$67.00 EA</b> ⚠ |
| <b>4447SD</b> .....                           | <b>53-54</b>        |
| Wagon (Sliding)(fits 8 passenger) Tinted      |                     |
| Grey 11.011 -0.15 .....                       | <b>\$77.50 EA</b> ⚠ |
| <b>4447ST</b> .....                           | <b>53-54</b>        |
| Wagon (Sliding)(fits 8 passenger) Tinted      |                     |
| Green 11.011 -0.15 .....                      | <b>\$70.50 EA</b> ⚠ |
| <b>4451S</b> .....                            | <b>53-54</b>        |
| 2-door Sedan. Clear 11.011 -0.15 .....        | <b>\$56.00 EA</b> ⚠ |
| <b>4451SD</b> .....                           | <b>53-54</b>        |
| 2 Door Sedan. Tinted Grey 11.011 -0.15 .....  | <b>\$70.00 EA</b> ⚠ |
| <b>4451ST</b> .....                           | <b>53-54</b>        |
| 2 Door Sedan. Tinted Green 11.011 -0.15 ..... | <b>\$56.00 EA</b> ⚠ |

## Back Glass

Note: These back glasses are laminated and should be able to be cut for chopped top.

|   |                      |
|---|----------------------|
| <b>2633</b> .....                               | <b>37-38</b>         |
| Cabriolet. Clear 11.204 -0.15 .....             | <b>\$32.00 EA</b> ⚠  |
| <b>2633D</b> .....                              | <b>37-38</b>         |
| Cabriolet. Tinted Grey 11.204 -0.15 .....       | <b>\$36.00 EA</b> ⚠  |
| <b>2633T</b> .....                              | <b>37-38</b>         |
| Cabriolet. Tinted Green 11.204 -0.15 .....      | <b>\$32.00 EA</b> ⚠  |
| <b>2631</b> .....                               | <b>37-39</b>         |
| Sedan Delivery. Clear 11.204 -0.15 .....        | <b>\$44.00 EA</b> ⚠  |
| <b>2631D</b> .....                              | <b>37-39</b>         |
| Sedan Delivery. Tinted Grey 11.204 -0.15 .....  | <b>\$50.00 EA</b> ⚠  |
| <b>2631T</b> .....                              | <b>37-39</b>         |
| Sedan Delivery. Tinted Green 11.204 -0.15 ..... | <b>\$44.00 EA</b> ⚠  |
| <b>2719</b> .....                               | <b>37-39</b>         |
| Exc Sedan Delivery, Cabriolet. Clear            |                      |
| 11.204 -0.15 .....                              | <b>\$68.00 EA</b> ⚠  |
| <b>2719D</b> .....                              | <b>37-39</b>         |
| Exc Sedan Delivery, Cabriolet. Tinted Grey      |                      |
| 11.204 -0.15 .....                              | <b>\$74.00 EA</b> ⚠  |
| <b>2804</b> .....                               | <b>40</b>            |
| Cabriolet. Laminated glass. Clear               |                      |
| 11.204 -0.15 .....                              | <b>\$34.00 EA</b> ⚠  |
| <b>2804D</b> .....                              | <b>40</b>            |
| Cabriolet. Tinted Grey 11.204 -0.15 .....       | <b>\$38.00 EA</b> ⚠  |
| <b>2804T</b> .....                              | <b>40</b>            |
| Cabriolet. Tinted Green 11.204 -0.15 .....      | <b>\$34.00 EA</b> ⚠  |
| <b>BBB4</b> .....                               | <b>40</b>            |
| Exc Sedan Delivery, Cabriolet. Clear            |                      |
| 11.204 -0.15 .....                              | <b>\$350.00 EA</b> ⚠ |
| <b>BBB4G</b> .....                              | <b>40</b>            |
| Exc Sedan Delivery, Cabriolet. Tinted Grey      |                      |
| 11.204 -0.15 .....                              | <b>\$350.00 EA</b> ⚠ |
| <b>BBB4GR</b> .....                             | <b>40</b>            |
| Exc Sedan Delivery, Cabriolet. Tinted           |                      |
| Green -0.15 .....                               | <b>\$350.00 EA</b> ⚠ |

## Back Glass, cont.

|   |                      |
|---|----------------------|
| <b>2528S</b> .....                          | <b>40-48</b>         |
| Sedan Delivery. Clear 11.204 -0.15 .....    | <b>\$44.00 EA</b> ⚠  |
| <b>2528SD</b> .....                         | <b>40-48</b>         |
| Sedan Delivery. Grey tint 11.204 -0.15 ..   | <b>\$50.00 EA</b> ⚠  |
| <b>2528ST</b> .....                         | <b>40-48</b>         |
| Sedan Delivery. Green tint 11.204 -0.15 ..  | <b>\$44.00 EA</b> ⚠  |
| <b>2652S</b> .....                          | <b>41</b>            |
| Wagon. Clear 11.204 -0.15 .....             | <b>\$78.50 EA</b> ⚠  |
| <b>2652SD</b> .....                         | <b>41</b>            |
| Wagon. Grey tint 11.204 -0.15 .....         | <b>\$103.75 EA</b> ⚠ |
| <b>2652ST</b> .....                         | <b>41</b>            |
| Wagon. Green tint -0.15 ..                  | <b>\$83.00 EA</b> ⚠  |
| <b>BB18</b> .....                           | <b>41-48</b>         |
| Exc Fleetline. Clear 11.204 -0.15 .....     | <b>\$330.00 EA</b> ⚠ |
| <b>BB18G</b> .....                          | <b>41-48</b>         |
| Exc Fleetline. Tinted Grey 11.204 -0.15 ..  | <b>\$367.50 EA</b> ⚠ |
| <b>BB18GR</b> .....                         | <b>41-48</b>         |
| Exc Fleetline. Tinted Green 11.204 -0.15 .. | <b>\$330.00 EA</b> ⚠ |
| <b>BB32</b> .....                           | <b>41-48</b>         |
| Four door Fleetline. Clear 11.204 -0.15 ..  | <b>\$335.00 EA</b> ⚠ |
| <b>BB32G</b> .....                          | <b>41-48</b>         |
| Four door Fleetline. Tinted Grey            |                      |
| 11.204 -0.15 .....                          | <b>\$330.00 EA</b> ⚠ |
| <b>BB32GR</b> .....                         | <b>41-48</b>         |
| Four door Fleetline. Tinted Green           |                      |
| 11.204 -0.15 .....                          | <b>\$324.75 EA</b> ⚠ |
| <b>2565S</b> .....                          | <b>41-50</b>         |
| Cabriolet window. Clear. Lexan w/ anti      |                      |
| scratch, light makes rear curtain hang      |                      |
| better. 11.204 -0.15 .....                  | <b>\$28.00 EA</b> ⚠  |
| <b>2565SD</b> .....                         | <b>41-50</b>         |
| Cabriolet. Tinted Grey 11.204-0.15 .....    | <b>\$32.00 EA</b> ⚠  |
| <b>2565ST</b> .....                         | <b>41-50</b>         |
| Cabriolet. Tinted Green -0.15 .....         | <b>\$28.00 EA</b> ⚠  |
| <b>2632S</b> .....                          | <b>42</b>            |
| Wagon. Clear 11.204 -0.15 .....             | <b>\$42.75 EA</b> ⚠  |
| <b>2632ST</b> .....                         | <b>42</b>            |
| Wagon. Tinted Green 11.204 -0.15 .....      | <b>\$50.50 EA</b> ⚠  |
| <b>BB37</b> .....                           | <b>42-48</b>         |
| Fleetline Aero Sedan 2-door. Clear          |                      |
| 11.204 -0.15 .....                          | <b>\$320.00 EA</b> ⚠ |
| <b>BB37G</b> .....                          | <b>42-48</b>         |
| Fleetline Aero Sedan 2 Door. Tinted Grey    |                      |
| 11.204 -0.15 .....                          | <b>\$330.00 EA</b> ⚠ |
| <b>BB37T</b> .....                          | <b>42-48</b>         |
| Fleetline Aero Sedan 2-door. Tinted Green   |                      |
| 11.204 -0.15 .....                          | <b>\$320.00 EA</b> ⚠ |
| <b>2708S</b> .....                          | <b>46-48</b>         |
| Wagon. Clear 11.204 -0.15 .....             | <b>\$91.00 EA</b> ⚠  |
| <b>2708SD</b> .....                         | <b>46-48</b>         |
| Wagon. Tinted Grey 11.204 -0.15 .....       | <b>\$93.75 EA</b> ⚠  |

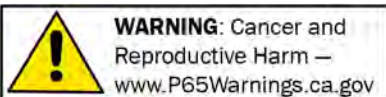

Chemicals shipped domestic ground only (Lower 48 states only). No international shipping.

Phone: (360) 816-0211 • (800) 999-CHEV (2438) • www.chevsofthe40s.com



## Section 420C: Glass

### Back Glass, cont.

|  |                    |
|--|--------------------|
| <b>2708ST</b> .....                              | <b>46-48</b>       |
| Wagon. Tinted Green 11.204 -0.15 .....           |                    |
| <b>\$75.00 EA</b> ⚠                              |                    |
| <b>1071S</b> .....                               | <b>48</b>          |
| Wagon. Clear 11.204 -0.15 ..                     | <b>\$116.75 EA</b> |
| ⚠  |                    |
| <b>1071SD</b> .....                              | <b>48</b>          |
| Wagon. Tinted Grey 11.204 -0.15 .....            |                    |
| <b>\$155.50 EA</b> ⚠                             |                    |
| <b>1071ST</b> .....                              | <b>48</b>          |
| Wagon. Tinted Green 11.204 -0.15 .....           |                    |
| <b>\$124.00 EA</b> ⚠                             |                    |
| <b>1074S</b> .....                               | <b>49</b>          |
| Wood Wagon. Clear 11.204 -0.15 .....             |                    |
| <b>\$119.75 EA</b> ⚠                             |                    |
| <b>1074ST</b> .....                              | <b>49</b>          |
| Wood Wagon. Tinted Green 11.204 -0.15 .....      |                    |
| <b>\$123.00 EA</b> ⚠                             |                    |
| <b>DB118</b> .....                               | <b>49-52</b>       |
| Fleetline. Clear 11.204 -0.15                    | <b>\$345.25 EA</b> |
| ⚠  |                    |
| <b>DB118G</b> .....                              | <b>49-52</b>       |
| Fleetline. Tinted Grey 11.204 -0.15 .....        |                    |
| <b>\$330.00 EA</b> ⚠                             |                    |
| <b>DB118T</b> .....                              | <b>49-52</b>       |
| Fleetline. Tinted Green 11.204 -0.15 .....       |                    |
| <b>\$320.00 EA</b> ⚠                             |                    |
| <b>DB119</b> .....                               | <b>49-52</b>       |
| Styleline Coupe. Clear 11.204 -0.15 .....        |                    |
| <b>\$320.00 EA</b> ⚠                             |                    |
| <b>DB119G</b> .....                              | <b>49-52</b>       |
| Styleline Coupe. Tinted Grey 11.204 -0.15 .....  |                    |
| <b>\$360.00 EA</b> ⚠                             |                    |
| <b>DB119T</b> .....                              | <b>49-52</b>       |
| Styleline Coupe. Tinted Green 11.204 -0.15 ..... |                    |
| <b>\$320.00 EA</b> ⚠                             |                    |
| <b>DB120</b> .....                               | <b>49-52</b>       |
| Styleline. Clear Sedan only 11.204 -0.15 .....   |                    |
| <b>\$320.00 EA</b> ⚠                             |                    |
| <b>DB120G</b> .....                              | <b>49-52</b>       |
| Styleline Sedan. Tinted Grey 11.204 -0.15 .....  |                    |
| <b>\$360.00 EA</b> ⚠                             |                    |
| <b>DB120T</b> .....                              | <b>49-52</b>       |
| Styleline Sedan. Tinted Green 11.204 -0.15 ..... |                    |
| <b>\$320.00 EA</b> ⚠                             |                    |
| <b>1073S</b> .....                               | <b>49-54</b>       |
| Metal wagon. Clear 11.204 -0.15 .....            |                    |
| <b>\$120.00 EA</b> ⚠                             |                    |
| <b>1073SD</b> .....                              | <b>49-54</b>       |
| Metal Wagon. Tinted Grey 11.204 -0.15 ..         |                    |
| <b>\$153.75 EA</b> ⚠                             |                    |
| <b>1073ST</b> .....                              | <b>49-54</b>       |
| Metal Wagon. Tinted Green 11.204 -0.15 .....     |                    |
| <b>\$128.00 EA</b> ⚠                             |                    |
| <b>DB117</b> .....                               | <b>49-54</b>       |
| Sedan Delivery. Clear 11.204 -0.15 .....         |                    |
| <b>\$323.75 EA</b> ⚠                             |                    |
| <b>DB117G</b> .....                              | <b>49-54</b>       |
| Sedan Delivery. Tinted Grey 11.204 -0.15 .....   |                    |
| <b>\$370.00 EA</b> ⚠                             |                    |
| <b>DB117T</b> .....                              | <b>49-54</b>       |
| Sedan Delivery. Tinted Green 11.204 -0.15 .....  |                    |
| <b>\$350.00 EA</b> ⚠                             |                    |

### Back Glass, cont.

|   |                      |
|---|----------------------|
| <b>DB148</b> .....                                  | <b>50-52</b>         |
| Bel Air hardtop. Right side. Clear                  |                      |
| 11.204 -0.15 .....                                  | <b>\$130.00 EA</b> ⚠ |
| <b>DB148G</b> .....                                 | <b>50-52</b>         |
| Bel Air hardtop. Right side. Tinted Grey            |                      |
| 11.204 -0.15 .....                                  | <b>\$144.00 EA</b> ⚠ |
| <b>DB148T</b> .....                                 | <b>50-52</b>         |
| Bel Air hardtop. Right side. Tinted Green           |                      |
| 11.204 -0.15 .....                                  | <b>\$130.00 EA</b> ⚠ |
| <b>DB149</b> .....                                  | <b>50-52</b>         |
| Bel Air hardtop Left side. Clear 11.204 -0.15 ..... |                      |
| <b>\$130.00 EA</b> ⚠                                |                      |
| <b>DB149G</b> .....                                 | <b>50-52</b>         |
| Bel Air hardtop. Left side. Tinted Grey             |                      |
| 11.204 -0.15 .....                                  | <b>\$144.00 EA</b> ⚠ |
| <b>DB149T</b> .....                                 | <b>50-52</b>         |
| Bel Air hardtop. Left side. Tinted Green            |                      |
| 11.204 -0.15 .....                                  | <b>\$130.00 EA</b> ⚠ |
| <b>DB150</b> .....                                  | <b>50-52</b>         |
| Bel Air hardtop. Center. Clear 11.204 -0.15 .....   |                      |
| <b>\$247.25 EA</b> ⚠                                |                      |
| <b>DB150G</b> .....                                 | <b>50-52</b>         |
| Bel Air hardtop. Center. Tinted Grey                |                      |
| 11.204 -0.15 .....                                  | <b>\$264.00 EA</b> ⚠ |
| <b>DB150T</b> .....                                 | <b>50-52</b>         |
| Bel Air hardtop. Center. Tinted Green               |                      |
| 11.204 -0.15 .....                                  | <b>\$246.00 EA</b> ⚠ |
| <b>DB320</b> .....                                  | <b>53-54</b>         |
| Coupe 150 & 210, 2 or 4 door. Clear                 |                      |
| (small back glass, not wrap-around)                 |                      |
| 11.204 -0.15 .....                                  | <b>\$350.00 EA</b> ⚠ |
| <b>DB320G</b> .....                                 | <b>53-54</b>         |
| Coupe 150 & 210, 2 or 4 door. Tinted                |                      |
| Grey (small back glass, not wrap-around)            |                      |
| 11.204 -0.15 .....                                  | <b>\$350.00 EA</b> ⚠ |
| <b>DB320T</b> .....                                 | <b>53-54</b>         |
| Coupe 150 & 210, 2 or 4 door. Tinted                |                      |
| Green (small back glass, not wrap-                  |                      |
| around) 11.204 -0.15 .....                          | <b>\$330.00 EA</b> ⚠ |
| <b>DB321</b> .....                                  | <b>53-54</b>         |
| Sedan 2 & 4 door. Clear glass (wrap-                |                      |
| around back window) 11.204 -0.15 .....              |                      |
| <b>\$370.00 EA</b> ⚠                                |                      |
| <b>DB321G</b> .....                                 | <b>53-54</b>         |
| Sedan 2 & 4 door. Tinted Grey glass                 |                      |
| (wrap-around back window) 11.204 -0.15 .....        |                      |
| <b>\$410.00 EA</b> ⚠                                |                      |
| <b>DB321T</b> .....                                 | <b>53-54</b>         |
| Sedan 2 & 4 door. Tinted Green (wrap-               |                      |
| around back window) 11.204 -0.15 .....              |                      |
| <b>\$370.00 EA</b> ⚠                                |                      |
| <b>DB322</b> .....                                  | <b>53-54</b>         |
| Hardtop. Clear. 11.204 -0.15                        | <b>\$530.00 EA</b>   |
| ⚠   |                      |
| <b>DB322G</b> .....                                 | <b>53-54</b>         |
| Hardtop. Grey. 11.204 -0.15                         | <b>\$430.00 EA</b>   |
| ⚠   |                      |
| <b>DB322T</b> .....                                 | <b>53-54</b>         |
| Hardtop. Tinted Green 11.204 -0.15 .....            |                      |
| <b>\$530.00 EA</b> ⚠                                |                      |

Returns require a return authorization number—call first. • Product pricing & availability subject to change.



*Refer to section numbers below for specific weatherstrip needed for your vehicle.*

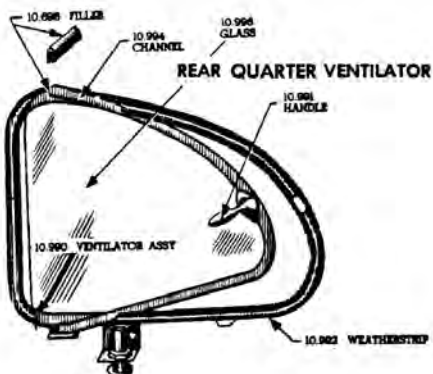
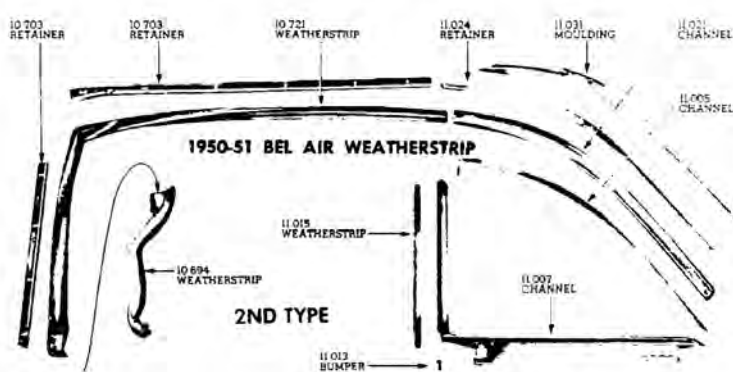
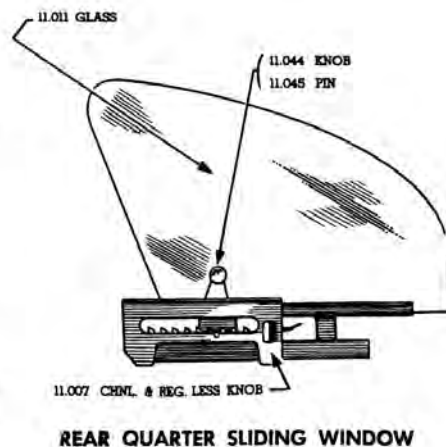
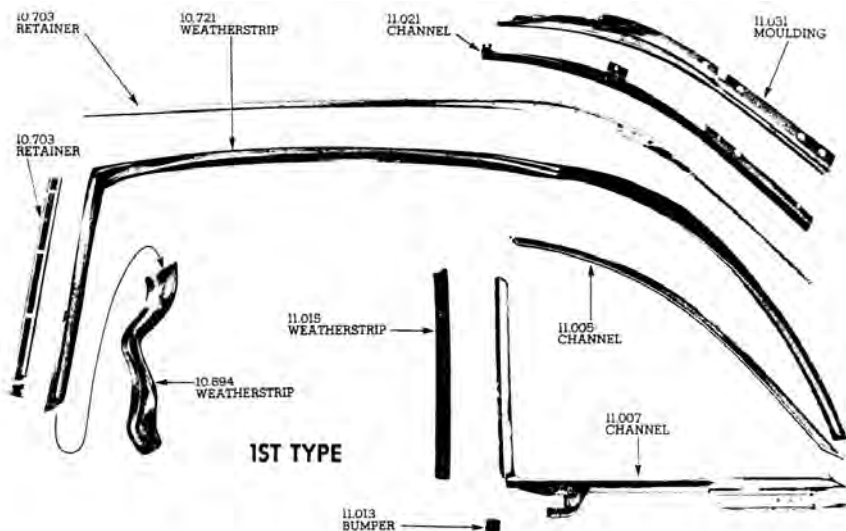
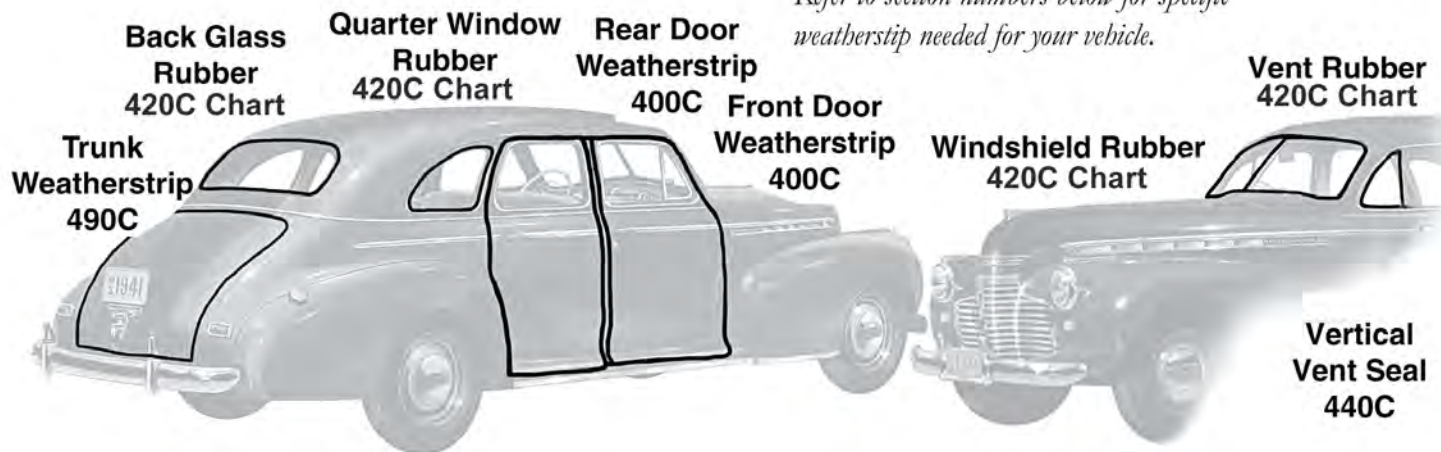

**WARNING: Cancer and Reproductive Harm** —  
www.P65Warnings.ca.gov

Chemicals shipped domestic ground only (Lower 48 states only). No international shipping.

Phone: (360) 816-0211 • (800) 999-CHEV (2438) • www.chevsofthe40s.com



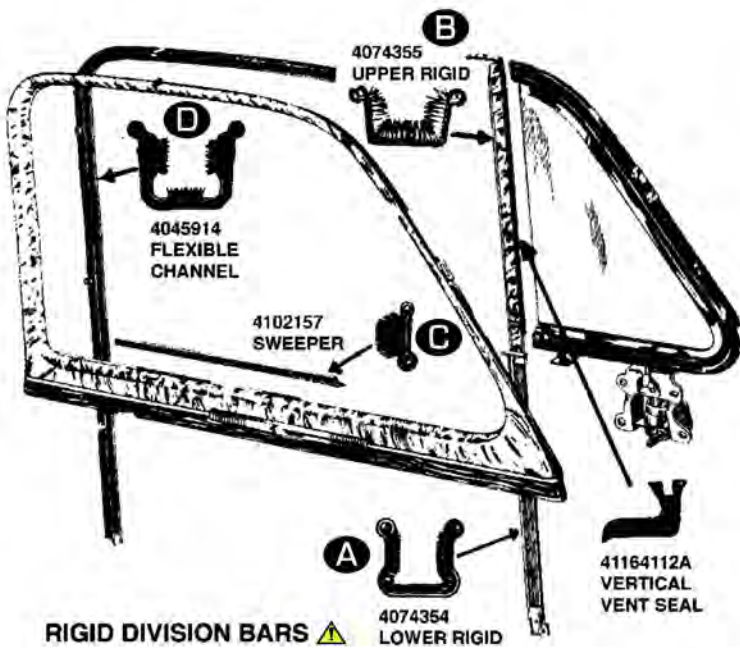

**RIGID DIVISION BARS** ⚠️

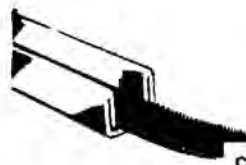

FOR RELINING PERMANENT GUIDE BARS ON A FEW CONVERTIBLES. BLACK MOHAIR LINING MATERIAL WITH RUBBERIZED BACKING TO BE CEMENTED IN PLACE.

CC 22 (1 5/8" WIDE) \$16.00 FT.

**For all Nomads & Wagons**

'46-'56 GLASS SETTING SEAL USED ON TL GATE ONLY.  
 01C201PL \$3.50 FT.



LOWER SIDE WINDOW CARRIER GLASS SETTING WITH WEATHER LIP FOR 5/8 CHANNEL DEPTH.  
 '30-'40 CHEV.  
 '46-'56 STATION WAGON  
 01A201PL \$9.75 FT.

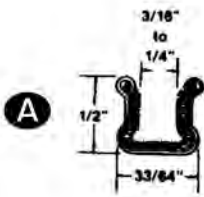

'40-'60 GM RIGID RUN CHANNEL SIDE WINDOW, LOWER  
 4074354-36" PC. \$19.50 EA

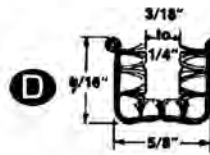

FLEXIBLE GLASS CHANNEL, MOHAIR LINED, CLOTH COVERED, STAINLESS STEEL BEADS. FITS '33-'60 GM SIDE WINDOWS.

4045914-108" PC. \$46.25 EA  
 4075477-96" PC. \$46.25 EA  
 4075477-72" PC. \$42.75 EA

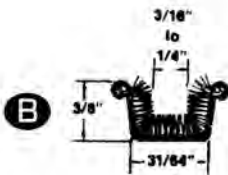

'33-'60 GM CARS RIGID DIVISION BAR WITH STAINLESS STEEL BEAD  
 4074355-36" PC. \$59 EA  
 ACTUAL SIZE

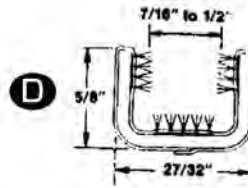

FLEXIBLE GLASS CHANNEL, MOHAIR LINING. '50-'63 CHEV & GMC TRUCKS '41-'64 GM CARS. FOR WINDOWS WITH METAL FRAMES ONLY.

3684434A-96" PC. \$64.75 EA

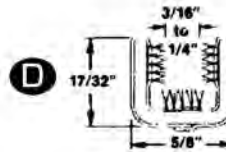

FLEXIBLE, UNBEADED PILE LINED. FITS '33-'62 CHEV & GMC PICKUPS & PANELS WITHOUT FRAMED SIDE GLASS.

598746-96" PC. \$29.00 EA



FLEXIBLE SWEEPER G.M.C. TRUCKS '46-'49 LATE '50's GM CARS STAINLESS STEEL BEAD  
 3684760 \$0.75 per inch



FLEXIBLE SWEEPER '33-'60 CHEV  
 INNER & OUTER BELT-LINE. ALSO SLIDING QTR. WINDOWS. EASILY FORMED FOR QTR.WIND.  
 STAINLESS STEEL BEAD  
 4102157 \$0.50 per inch



**2127 Parkerized**

Door window reveal moulding fastener, corner: Chevrolet '41-'48 Special Deluxe Oldsmobile '41-'48, Model 60 Pontiac '41-'48, Models 25 and 27 CALL

TO BE SLIPPED ON DOOR PANEL FASTENER STRIP FOR REPAIRS TO REPLACE BROKEN NAILS IN PANEL EDGING.



7/16" NAIL (.460)  
 ALL GENERAL MOTORS  
 "NAIL ON" DOOR PANEL REPAIR CLIPS  
 WF18 \$2.00 (2 pcs)

**SECTION 430C  
STREET ROD PARTS**

**Windshield Rubber for One Piece  
V-Bent And Two Piece V-Butt  
Windshield**



**4073730A** ..... **37-38**  
Windshield (no center division bar).  
10.092 -0.15 ..... **\$141.00 EA** ⚠️



**4099966A** ..... **39-40**  
Windshield w/out moulding (no center  
division bar)-Master Deluxe. 10.092 -0.15  
..... **\$160.50 EA** ⚠️

**4099932A** ..... **40**  
Windshield w/ moulding (no center  
division bar)-Special Deluxe. 10.092 -0.4  
..... **\$56.00 EA** ⚠️

**4122594A** ..... **41-48**  
Windshield w/ moulding (no center  
division bar) exc Aero. 10.092 -0.3  
..... **\$56.00 EA** ⚠️



**4125418A** ..... **42-48**  
Windshield (no center division bar)-  
Fleetline 2-door (Aero). 10.092 -0.4  
..... **\$56.00 EA** ⚠️

**4573857A** ..... **49-52**  
For one-piece windshield w/ moulding  
- Convertible, Hardtop. 10.092 -0.4  
..... **\$108.00 EA** ⚠️

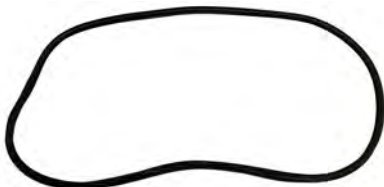

**4573858A** ..... **49-52**  
For one-piece windshield-Wagon  
10.092 -0.15 ..... **\$155.25 EA** ⚠️

**Windshield Rubber for One Piece  
V-Bent And Two Piece V-Butt  
Windshield, cont.**

**4587340A** ..... **49-52**  
For one-piece windshield w/ moulding-all  
Styleline (exc Convertible, Hardtop,  
Fleetline). 10.092 -0 ..... **\$104.00 EA** ⚠️

**4595280A** ..... **49-52**  
For one-piece windshield w/ moulding-  
Fleetline. 10.092 -0 ..... **CALL** ⚠️

**SECTION 430C  
RESTORATION PARTS**

**Windshield Interior**

**4081936** ..... **37-38**  
Vertical divider  
moulding (stainless steel) 10.053 -0.15  
**\$45.25 EA** ⚠️



**4081918I** ..... **39**  
Vertical divider moulding (stainless steel)  
10.052 -0.15 ..... **\$62.50 EA** ⚠️

**4101928I** ..... **40**  
Vertical divider  
moulding (stainless steel). 14-1/4" long  
end-to-end. 10.052 -0 ..... **CALL** ⚠️

**4114980I** ..... **41-48**  
Vertical divider  
moulding (stainless steel). Will not fit  
Fleetline. 10.052 -0.15 ..... **CALL** ⚠️

**4098434I** ..... **42-48**  
Stainless Fits 2 Door  
Fleetline Aero Sedan -0.15 ..... **\$60.00 EA**  
⚠️

**Windshield Rubber**

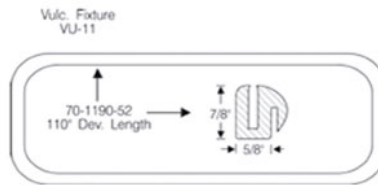

**4073730** ..... **37-38**  
W/ center divider. 10.092 -0 ..... **CALL** ⚠️



**4073730E** ..... **37-38**  
W/ center divider rubber. 10-32 thread  
10.092 -0 ..... **\$157.00 EA** ⚠️

**Windshield Rubber, cont.**

Vulc. Fixture  
VU-11

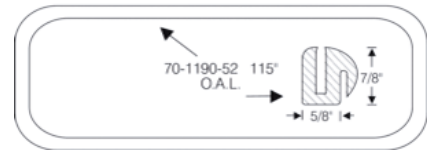

**4089916** ..... **39**  
Includes windshield center rubber  
#4089925 10.092 -0 ..... **CALL** ⚠️  
**4089916E** ..... **39**  
Includes windshield center rubber  
#4089925. 10.092 -0 ..... **\$156.00 EA**  
⚠️

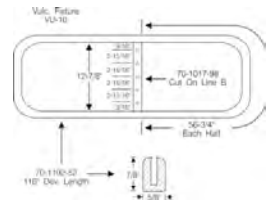

**4099932** ..... **40**  
Special Deluxe (now includes windshield  
center rubber #4099932B & pinchweld  
#4114861) 10.092 -0 ..... **CALL** ⚠️

**4099932E** ..... **40**  
Special Deluxe (now includes windshield  
center rubber #4099932B & pinchweld  
#4114861) 10.092 -0 ..... **\$188.00 EA** ⚠️

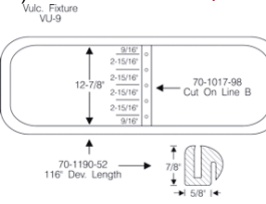

**4099966** ..... **40**  
Without moulding-Master Deluxe & Master  
85 10.092 -0 ..... **CALL** ⚠️



**4099966E** ..... **40**  
Without moulding-Master Deluxe & Master  
85 10.092 -0.15 ..... **\$244.00 EA** ⚠️



**4116250** ..... **41-48**  
Cars w/out moulding. Exc. Aero 10.092 -0.15  
..... **\$48.75 EA** ⚠️

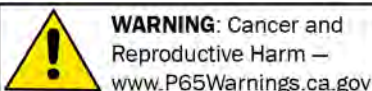

Chemicals shipped domestic ground only (Lower 48 states only). No international shipping.

**Phone: (360) 816-0211 • (800) 999-CHEV (2438) • www.chevsofthe40s.com**



# Section 430C: Windshield Rubber & Related

## Windshield Rubber, cont.



**4116250E** ..... **41-48**  
Cars w/out moulding. Exc. Aero 10.092 -0  
..... **\$160.00 EA** ⚠️

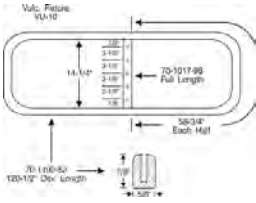

**4122594** ..... **41-48**  
Cars w/ moulding exc Aero (#4098434, #4114861 included) 10.092 -0  
..... **\$185.00 EA** ⚠️



**4125418** ..... **42-48**  
Fleetline 2-door Aero (now includes rubber channel #4098434 & pinchweld #4114861) 10.092 -0.15  
..... **\$95.00 EA** ⚠️



**4125418E** ..... **42-48**  
Fleetline 2-door Aero (now includes rubber channel #4098434 & pinchweld #4114861). 10.092 -0.15  
..... **\$249.50 EA** ⚠️

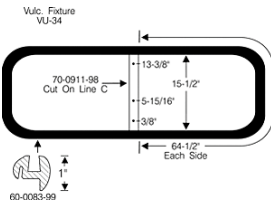

**4585281** ..... **49-51**  
Fleetline w/out moulding 10.092 -0.15  
..... **\$287.75 EA** ⚠️

## Windshield Rubber, cont.

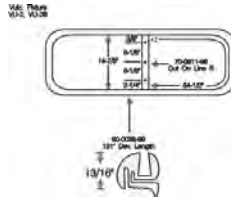

**4573857** ..... **49-52**  
Convertible & Hardtop 10.092 -0.15  
..... **\$84.00 EA** ⚠️

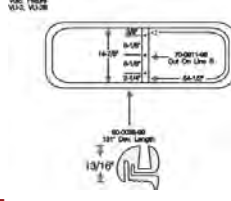

**4573857E** ..... **49-52**  
Convertible & Hardtop 10.092 -0.15  
..... **\$290.50 EA** ⚠️



**4573858** ..... **49-52**  
Station wagon 10.092 -0.15  
..... **\$310.00 EA** ⚠️



**4587340** ..... **49-52**  
Styleline Deluxe 2- & 4-door Sedan, Coupe, Sedan Delivery w/ moulding (has center divider) 10.092 -0.15  
..... **\$47.00 EA** ⚠️



**4587340E** ..... **49-52**  
Styleline Deluxe 2- & 4-door Sedan, Coupe & Sedan Delivery w/ moulding (has center divider) 10.092 -0.15  
..... **\$297.75 EA** ⚠️

## Windshield Rubber, cont.

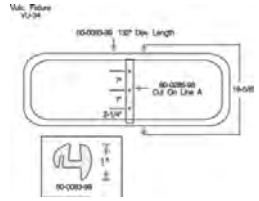

**4587341** ..... **49-52**  
Styleline Special 2- & 4-door w/out moulding 10.092 -0.15  
..... **\$59.50 EA** ⚠️

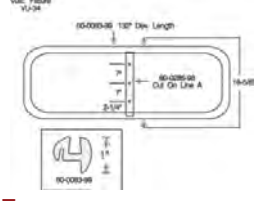

**4587341E** ..... **49-52**  
Styleline Special 2- & 4-door w/out moulding 10.092 -0.15  
..... **\$273.25 EA** ⚠️

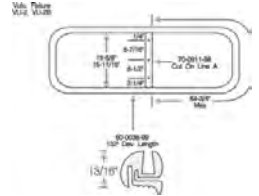

**4595280** ..... **49-52**  
Fleetline w/ mouldings 10.092 -0.15  
..... **\$345.75 EA** ⚠️

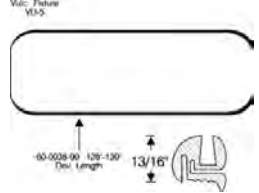

**4601373** ..... **53-54**  
Hardtop & Convertible 10.092 -0.15  
..... **\$180.25 EA** ⚠️

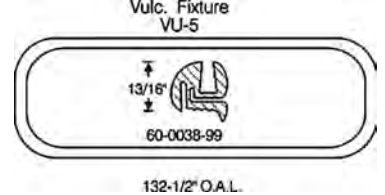

**4601374** ..... **53-54**  
W/ moulding-Bel Air, 210, Sedan Delivery, Wagon (exc Hardtop, Convertible) 10.092 -0  
..... **\$104.00 EA** ⚠️

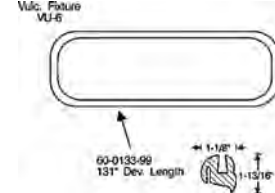

**4616205** ..... **53-54**  
150 Series & Wagon w/out moulding (exc Sedan Delivery) 10.092 -0.05  
..... **\$186.75 EA** ⚠️

Returns require a return authorization number—call first. • Product pricing & availability subject to change.

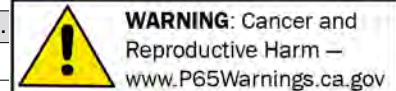

# Section 430C: Windshield Rubber & Related

## Windshield Center Rubber, cont.

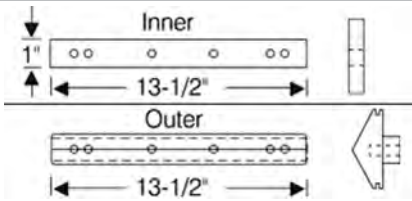

**4073730B** ..... **37-38**

Strip-inner, outer 10.054 -0.15

**\$94.75 SET** ⚠

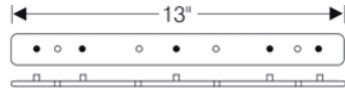

**4089925** ..... **39**

Division bar 10.054 -0.15

**\$78.25 EA** ⚠



**4099932B** ..... **40**

Division bar 10.054 -0.15

**\$37.75 EA** ⚠

## Windshield Center Rubber, cont.



**4122594B** ..... **41-48**

Division w/ holes 10.054 -0.15

**\$49.75 EA** ⚠

## Windshield Exterior



**4081935** ..... **37-38**

Vertical divider moulding (stainless steel)

10.052 -0.15

**\$54.00 EA** ⚠



**4081918** ..... **39**

Vertical divider moulding (stainless steel)

10.052 -0.15

**\$60.00 EA** ⚠



**4101928** ..... **40**

Vertical divider

moulding (stainless

steel). 14-1/4" long

end-to-end. 10.052 -0.15

**\$60.00 EA** ⚠

## Windshield Center Rubber, cont.

**4101928A** ..... **40**

Vertical windshield divider. Originally

welded into car. 10.052 -0.3

**\$59.50 EA** ⚠

**4114574A** ..... **41-48**

Vertical windshield divider. Originally

welded into car. (Exc. Aero) 10.052 -0.3

**\$60.75 EA** ⚠

**4114980** ..... **41-48**

Vertical divider

moulding (stainless

steel). Will not fit

Fleetline. 10.052 -0.15

**\$60.00 EA** ⚠

## Windshield Moulding Clips



**4574744** ..... **49-52**

Windshield center

divider 11.216 -0.4

**\$17.00 SET** ⚠

**4596461** ..... **53-54**

For moulding under windshield 10.093 -0.15

**\$6.50 SET** ⚠

These kits are super complete and include sweepers, rigid channels, flexible channel, stops, screws, clips and rubber bumpers as needed. Oversize shipping charges apply; please call for rates. Each kit does two doors. For cars, locate the appropriate channel kit for your vehicle and add the suffix to the base part #4045914, i.e., 1941 Cabriolet = #4045914D41.

| #4045914                                | 1937           | 1938           | 1939           | 1940           | 1941         | 1942           | 1946           | 1947           | 1948           | 1949         | 1950         | 1951         | 1952         | 1953            | 1954            |
|---|----------------|----------------|----------------|----------------|--------------|----------------|----------------|----------------|----------------|--------------|--------------|--------------|--------------|-----------------|-----------------|
| FRONT DOOR (2-DR SEDAN)                 | S38<br>\$145   | S38<br>\$145   | S40<br>\$145   | S40<br>\$145   | S48<br>\$130 | S48<br>\$130   | S48<br>\$130   | S48<br>\$130   | S48<br>\$130   | S52<br>\$171 | S52<br>\$171 | S52<br>\$171 | S52<br>\$171 | S54<br>\$175    | S54<br>\$175    |
| FRONT DOOR (4-DR WAGON, SEDAN DEL.)     | B38<br>\$155   | B38<br>\$155   | B40<br>\$135   | B40<br>\$135   | B48<br>\$200 | B48<br>\$200   | B48<br>\$200   | B48<br>\$200   | B48<br>\$200   | B52<br>\$135 | B52<br>\$135 | B52<br>\$135 | B52<br>\$135 | B54<br>\$135    | B54<br>\$135    |
| FRONT DOOR (CBL/CONVT)                  | D38<br>\$62.75 | D38<br>\$62.75 | D40<br>\$62.75 | D40<br>\$62.75 | D41<br>\$64  | E48<br>\$79.50 | E48<br>\$79.50 | E48<br>\$79.50 | E48<br>\$79.50 | G52<br>\$120 | G52<br>\$120 | G52<br>\$120 | G52<br>\$120 | U54<br>\$93.25  | U54<br>\$93.25  |
| FRONT DOOR (COUPE)                      | C38<br>\$145   | C38<br>\$145   | C40<br>\$135   | C40<br>\$135   | C48<br>\$145 | C48<br>\$145   | C48<br>\$145   | C48<br>\$145   | C48<br>\$145   | C52<br>\$161 | C52<br>\$161 | C52<br>\$161 | C52<br>\$161 | C54<br>\$164    | C54<br>\$164    |
| FRONT DOOR (2-DR FLEETLINE)             | -              | -              | -              | -              | -            | S42<br>\$120   | S42<br>\$120   | S42<br>\$120   | S42<br>\$120   | S52<br>\$171 | S52<br>\$171 | S52<br>\$171 | S52<br>\$171 | -               | -               |
| FRONT DOOR (4-DR FLEETLINE/HARDTOP)     | -              | -              | -              | -              | A48<br>\$135 | A48<br>\$135   | A48<br>\$135   | A48<br>\$135   | A48<br>\$135   | -            | E52<br>\$85  | E52<br>\$85  | E52<br>\$85  | F54<br>\$114.50 | F54<br>\$114.50 |
| REAR DOOR (4-DR & WAGON, EXC FLEETLINE) | K38<br>\$112   | K38<br>\$112   | K40<br>\$150   | K40<br>\$150   | K48<br>\$125 | K48<br>\$125   | K48<br>\$125   | K48<br>\$125   | K48<br>\$125   | L52<br>\$165 | L52<br>\$165 | L52<br>\$165 | L52<br>\$165 | K54<br>\$136    | K54<br>\$136    |
| REAR DOOR (4-DR FLEETLINE)              | -              | -              | -              | -              | -            | L48<br>\$120   | L48<br>\$120   | L48<br>\$120   | L48<br>\$120   | L52<br>\$165 | L52<br>\$165 | L52<br>\$165 | -            | -               | -               |

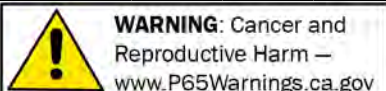

Chemicals shipped domestic ground only (Lower 48 states only). No international shipping.

Phone: (360) 816-0211 • (800) 999-CHEV (2438) • www.chevsofthe40s.com



**Section 430C: Windshield Rubber & Related**

**Section 440C: Door Vent Window Rubber & Related**

**Windshield Moulding Screws**



**01K5411.....41-48**  
Fits center windshield divider. 21.999 -0.3  
**\$12.50 SET** ⚠️

**Rubber Channel**



**4098434.....41-48**  
Holds exterior center moulding 10.054 -0.15  
**\$48.00 EA** ⚠️



**4098434A .....42-48**  
Holds exterior center moulding-Fleetline 2-door 10.054 -0.15  
**\$48.00 EA** ⚠️

**Pinch Weld Rubber**

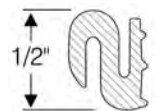

**4114861B ..... 40**  
Retains moulding (10 ft) 10.097 -0  
**\$30.00 EA** ⚠️

**4114861BULK ..... 40-48**

Sold by the foot 10.097 -0 **\$3.00 FT** ⚠️

**4114861 ..... 41-48**

Holds stainless steel border moulding (needed w/ following windshield rubber #4122594A & #4125418A) 10.097 -0

**\$30.00 EA** ⚠️

**Adhesives & Sealers**



**GL14 .....ALL**  
Windshield sealer. Seals leaks in new & old installation. Will not dry out rubber. Remains

pliable. 8.991 -0.15 **\$13.00 EA** ⚠️

**SECTION 440C STREET ROD PARTS**

**Air Deflector**



**986149.....ALL**  
Attaches to vent window. Specify color: Amber, Red, Blue or Green. 9.694 -0  
starting at **\$11.25 PR** ⚠️



**986149S .....ALL**  
Attaches to vent window. Stainless steel 9.694 -0.15  
**\$20.25 PR** ⚠️

**Adhesives And Sealers**



**511114.....ALL**  
3M, Black weatherstrip cement, 5-oz tube. Superior product!. 8.800 -0.2  
**\$23.75 EA** ⚠️



**986199A .....ALL**  
3M Contact cement for rubber to metal. Bonds instantly. Industrial quality for gravel guards, running board rubber, etc. 8.800 -0.15  
**\$79.50 QT** ⚠️



**GL14 .....ALL**  
Windshield sealer. Seals leaks in new & old installation. Will not dry out rubber. Remains pliable. 8.991 -0.15  
**\$13.00 EA** ⚠️

**SECTION 440C RESTORATION PARTS**

**Frame Vent Glass**



**4075339.....37-39**  
Chrome original 37-38, exc Cabriolet. 10.655 -0  
**CALL** ⚠️



**4089974.....37-39**  
Chrome (locking) original 39. 10.655 -0  
**CALL** ⚠️

**Setting Tape**

**603954BULK^.....ALL**  
1/32 in. thick, sold by the inch 10.696 -0.2  
**\$0.25 IN** ⚠️



**603954C.....ALL**  
Vent glass. Does both sides. (120 in. length) 10.696 -0.15  
**\$16.25 SET** ⚠️

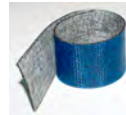

**603955BULK^.....ALL**  
Setting tape 1/16 in. thick sold by the inch 10.696 -0.3  
**\$0.25 IN** ⚠️

**Post Channel**



**4090059 .....37-39**  
Window channel at vent post, front of door glass. Upper & lower. 10.686 -0.15  
**\$329.75 L&R** ⚠️

**Vent Latch Handle**



**4167988.....49-52**  
Right side for all 2-door and rear door on 4-door Styleline Deluxe and Fleetline. 10.664 -0.15  
**\$23.75 EA** ⚠️



**4167989.....49-52**  
Left side for all 2-door and rear door on 4-door Styleline Deluxe and Fleetline. 10.664 -0.15  
**\$23.75 EA** ⚠️

**Vent Latch Repair Kit**



**4128367A .....39-48**  
Front or rear 10.659 -0.4  
**\$20.00 EA** ⚠️

**Pivot Pin**



**4173376.....49-57**  
Vent window. Upper. 10.669 -0.4  
**\$2.50 PR** ⚠️

**Tool**



**4173376A .....49-65**  
Sets vent window pivot pin. 10.669 -0.15  
**\$5.00 EA** ⚠️

Returns require a return authorization number—call first. • Product pricing & availability subject to change.

242 Phone: (360) 816-0211 • (800) 999-CHEV (2438) • www.chevsofthe40s.com

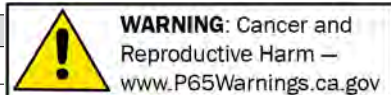

# Section 440C: Door Vent Window Rubber & Related

## Clip



**4155278.....53-68**  
Vent window regulator  
spring 10.661-0 . **CALL**  
⚠️

## Front Door Vent Glass Rubber With Vertical Vent Seals

Note: American made front door vent glass rubber. Vertical vent seal is now included!



- 4081968A.....37-38**  
Cabriolet 10.652-0.15 . **\$180.00 L&R**  
⚠️
- 4081806.....37-39**  
Exc Cabriolet 10.652-0.15 . . . . .  
**\$144.75 SET** ⚠️
- 4081806E.....37-39**  
Exc Cabriolet 10.652-0 . . . . .  
**\$165.00 SET** ⚠️
- 4101984A.....40**  
Exc Cabriolet 10.652-0.15 . . . . .  
**\$150.00 L&R** ⚠️
- 4101996A.....40**  
Cabriolet 10.652-0.15 . . . . .  
**\$130.00 L&R** ⚠️
- 4117557A.....41-46**  
Except Aerosedan, Cabriolet, Wagon  
10.652-0 . . . . . **\$135.00 L&R** ⚠️
- 4118505A.....41-48**  
Cabriolet 10.652-0.15 . . . . .  
**\$130.00 L&R** ⚠️
- 4134791A.....42-46**  
Aerosedan only 10.652-0 . . . . .  
**\$180.00 L&R** ⚠️
- 4099409A.....46-48**  
Wagons 10.652-0.15 . . . . . **\$143.00 L&R** ⚠️
- 4117557B.....47-48**  
Except Aerosedan, Cabriolet, Wagon  
10.652-0 . . . . . **\$137.00 L&R** ⚠️

## Front Door Vent Glass Rubber With Vertical Vent Seals, cont.

- 4134791B.....47-48**  
Aerosedan only 10.652-0 . . . . .  
**\$189.00 L&R** ⚠️
- 4151480.....49-52**  
W/ upper hinge pins (exc Convertible,  
Hardtop) 10.652-0.15 . . . . . **\$132.75 L&R**  
⚠️
- 4169182.....49-52**  
W/ upper hinge pins-Convertible, Hardtop  
10.652-0 . . . . . **\$110.00 L&R** ⚠️
- 4191702.....53-54**  
W/ upper hinge pins-Convertible, Hardtop  
10.652-0.15 . . . . . **\$118.00 L&R** ⚠️
- 4191718.....53-54**  
W/ upper hinge pins (exc Convertible,  
Hardtop) 10.652-0.3 . . . . . **\$145.00 L&R** ⚠️

## Vertical Vent Seal

Note: Vertical vent seals are now included with front door vent glass rubber.



**4146804A.....33-60**  
Glue on, no metal back,  
two at 17" 10.686-0.15 . . . . .  
**\$17.50 PR** ⚠️

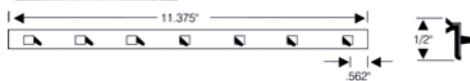

- 4116112A.....37-39**  
Metal core & tabs 10.686-0 . . . . .  
**\$36.75 L&R** ⚠️
- 4106666.....40**  
Metal core & tabs 10.686-0.15 . . . . .  
**\$73.50 L&R** ⚠️
- 4116112A.....41-46**  
Metal core & tabs exc Cabriolet 10.686-0 . . . . .  
**\$36.75 L&R** ⚠️
- 4190980A.....41-48**  
Metal core & tabs, Cabriolet 10.686-0.15 . . . . .  
**\$67.00 L&R** ⚠️

## Vertical Vent Seal, cont.

- 4116112C.....41-54**  
Front of rear door vent window w/ metal  
core & attaching tabs, trim to fit. 10.686-0 . . . . .  
**\$40.00 PR** ⚠️
- 4116112B.....47-48**  
Metal core & tabs exc Cabriolet  
10.686-0.15 . . . . . **\$73.50 L&R** ⚠️
- 4150496.....49-52**  
Vertical Vent Window Division Bar. Made  
in the USA. Fits Rear only 1949-1952 4  
door Sedan Styleline deluxe . 10.829-0 . . . . .  
**\$70.75 L&R** ⚠️
- 4180812.....49-52**  
W/ metal tabs-Hardtop, Convertible  
10.686-0.15 . . . . . **\$73.50 L&R** ⚠️
- 4190980.....49-52**  
W/ metal tab-exc Hardtop, Convertible  
10.686-0.15 . . . . . **\$73.50 L&R** ⚠️
- 4191700.....53-54**  
Glue on, no metal back, Hardtop,  
Convertible. Cut to desired length.  
10.686-0.15 . . . . . **\$21.50 EA** ⚠️
- 4191700A.....53-54**  
W/ metal tab-exc Hardtop, Convertible  
10.686-0.15 . . . . . **\$55.25 L&R** ⚠️

## Rear Door Vent Glass Rubber

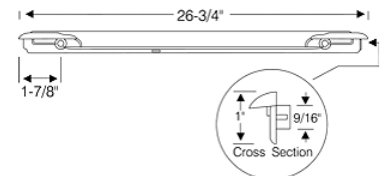

- 4128373.....41-48**  
Fleetline w/ opening window. Includes  
vertical vent seal. 10.822-0 . . . . .  
**\$144.00 L&R** ⚠️
- 4175652.....49-52**  
Fleetline w/ opening  
window. Includes  
vertical vent seal.  
10.822-0 . . . . .  
**\$158.00 PR** ⚠️

These kits are super complete and include flexible channel, sweepers, stops, screws, clips & rubber bumpers as needed. Complete for 2 quarter windows. For cars, locate the appropriate kit for your vehicle and add the suffix to the base part #4045914, i.e., 1941 Coupe = #4045914N54.

| #4045914                       | 1937         | 1938         | 1939         | 1940         | 1941         | 1942         | 1946         | 1947         | 1948         | 1949         | 1950         | 1951         | 1952         | 1953         | 1954         |
|--------------------------------|--------------|--------------|--------------|--------------|--------------|--------------|--------------|--------------|--------------|--------------|--------------|--------------|--------------|--------------|--------------|
| <b>QTR WINDOW (2-DR SEDAN)</b> | R38<br>\$200 | R38<br>\$200 | R40<br>\$200 | R40<br>\$200 | R48<br>\$200 | R48<br>\$200 | R48<br>\$200 | R48<br>\$200 | R48<br>\$200 | R52<br>\$200 | R52<br>\$200 | R52<br>\$200 | R52<br>\$200 | R54<br>\$200 | R54<br>\$200 |
| <b>QTR WINDOW (CBL/CONVT)</b>  | -            | -            | -            | -            | -            | J52<br>\$80  | J52<br>\$80  | J52<br>\$80  | J52<br>\$80  | J52<br>\$80  | J52<br>\$80  | J52<br>\$80  | J52<br>\$80  | R54<br>\$200 | R54<br>\$200 |
| <b>QTR WINDOW (HARDTOP)</b>    | -            | -            | -            | -            | -            | -            | -            | -            | -            | -            | M50<br>\$125 | M52<br>\$110 | M52<br>\$110 | M54<br>\$199 | M54<br>\$199 |
| <b>QTR WINDOW (COUPE/4-DR)</b> | -            | -            | N54<br>\$135 | N54<br>\$135 | N54<br>\$135 | N54<br>\$135 | N54<br>\$135 | N54<br>\$135 | N54<br>\$135 | N54<br>\$135 | N54<br>\$135 | N54<br>\$135 | N54<br>\$135 | -            | -            |
| <b>QTR WINDOW (WAGON)</b>      | -            | -            | -            | -            | -            | -            | T52<br>\$150 | T52<br>\$150 | T52<br>\$150 | T52<br>\$150 | T52<br>\$150 | T52<br>\$150 | T52<br>\$150 | T54<br>\$135 | T54<br>\$135 |

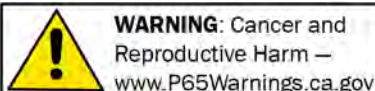

Chemicals shipped domestic ground only (Lower 48 states only). No international shipping.

**Phone: (360) 816-0211 • (800) 999-CHEV (2438) • www.chevsofthe40s.com**



## Section 440C: Door Vent Window Rubber & Related

## Section 450C: Door Window Channel Kits & Components

### Rear Door Vent Glass Rubber, cont.

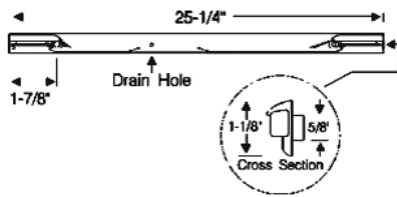

**4175694**.....**49-52**  
Styleline w/ opening window. Includes vertical vent seal. 10.822-0

**\$269.00 L&R** ⚠

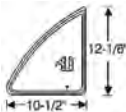

**4577610**.....**49-52**  
Styleline (fixed). 10.826-0.15

**\$201.50 L&R** ⚠

### Odds And Ends

Please call for availability on all Odds & Ends parts. Once part is sold, it may no longer be in stock.

**4106669**.....**40**

Rain Deflector Vent Shades, Good Used 32.000-0.4

**\$45.00 PR** ⚠

**4120828**.....**41-48**

Door vent rain deflector left hand 10.674-0.4

**\$20.00 EA** ⚠

**4561294U**.....**49-50**

Vent window frame assembly, left side, fits Fleetline (some rust on vent frame) 10.472-0.4

**\$50.00 EA** ⚠

**4191716**.....**53-54**

Pivot- Right Front Upper Vent Window -0.4

**\$10.00 EA** ⚠

## SECTION 450C RESTORATION PARTS

### Window Shades



**986274**.....**49-52**

Styleline 4 door 9.694-0.15

**\$99.00 SET** ⚠

### Channel Kit Components

Note: Below components are included in channel kits and available separately.

**4091152**.....**31-55**  
Door glass rubber roller. Fits hardtop & Convertible (4 pcs)

10.726-0.3

**\$9.00 SET** ⚠

**4072911**.....**37-38**  
Window anti-rattle bumpers (4 pcs)

11.139-0.4

**\$3.00 SET** ⚠

**4075434**.....**37-38**  
Rubber window channel w/ bowdrill cloth (lower channel at rear of door). Fits 2 doors (2 ft length)

10.701-0.15

**\$36.25 SET** ⚠

**4011688**.....**37-40**  
Window stop bumper, lower. Fits 2-door sedan

10.716-0.15

**\$5.00 PR** ⚠

**4114117**.....**40-54**  
Window stop bumper (upper). Fits hardtop & Convertible

10.716-0.2

**\$7.00 SET** ⚠

**4115231**.....**40-55**  
Rubber sweeper (in slot outside of door glass channel). Fits

Convertible & Hardtop (3ft) 10.720-0.15

**\$19.25 EA** ⚠

**4609684**.....**41-54**  
Window stop bumper (lower). Fits hardtop & Convertible

10.716-0.15

**\$7.50 PR** ⚠

**4131052**.....**41-57**  
Window stop bumper, lower (exc. Hardtop & Convertible)

10.716-0.15

**\$4.00 PR** ⚠

### Channel Kit Components, cont.

**4162170**.....**49-52**  
Anti-rattle bumpers on garnish moulding. Fits hardtop & Convertible (4 pcs) 11.139-0.15

**\$10.75 SET** ⚠

**4180904**.....**49-58**  
Window stop bumper. Top of vent divider bar. Fits hardtop &

Convertible 10.702-0.15

**\$49.25 PR** ⚠

**CC-22**.....**ALL**  
Black mohair lining material with rubber

backing, sold by the foot 10.000-0.15

**\$16.00 FT** ⚠

**WF11^**.....**ALL**  
Window Channel Screws (25 Piece)

10.000-0.3

**\$4.00 SET** ⚠

### Roof Rail Seal



**4605527**.....**50**  
Over door, quarter window & down windshield post-Bel Air Hardtop

10.721-0.15

**\$476.25 L&R** ⚠



**4600737**.....**50-51**  
Over door & down windshield post (not over quarter window. Fits Bel-Air Hardtop, 2nd design. 10.721-0.15

**\$383.00 L&R** ⚠

### Seal



**4615011**.....**52-54**  
Roof flipper to top-Hardtop 10.721-0.3

**\$40.25 PR** ⚠



**Door Glass Setting Kit Front**

Note: Below includes correct setting tape or rubber channel with flanged filler as needed. Hardtops & convertibles include setting tape for chrome window frames.



**4074657F.....37-38**  
Fits 2-door exc Cabriolet & Sedan Delivery (52in. length) 10.696 -0.3  
**\$13.00 SET** ⚠️

**4074657G.....37-38**  
Fits 4-door & Sedan Delivery (32in. length) 10.696 -0.3  
**\$8.00 SET** ⚠️



**603953F57....37-57**  
Fits Convertible & Hardtop Chrome window frames. (144 in. length) 10.696 -0.15  
**\$13.75 SET** ⚠️

**4099014F.....39-48**  
Fits 2-door exc Cabriolet & Sedan Delivery (52in. length) 10.696 -0  
**CALL** ⚠️

**4099014G.....39-48**  
Fits 4-door & Sedan Delivery (36in. length) 10.696 -0  
**CALL** ⚠️

**4598678F.....49-57**  
Fits 2-door exc Convertible, Hardtop & Sedan Delivery (48in. length) 10.696 -0  
**CALL** ⚠️



**4598678G.....49-57**  
Fits 4-door & Sedan Delivery (40in. length) 10.696 -0  
**\$23.25 SET** ⚠️

**Door Glass Setting Kit Rear**

**4074657R.....37-38**  
48in. length 10.696 -0.3  
**\$12.00 SET** ⚠️

**4099014R.....39-48**  
Fits 39-48 exc 41-48 Fleetline (36in. length) 10.696 -0  
**CALL** ⚠️



**4598678R.....41-54**  
Fits 41-48 Fleetline & all 49-54 (80in. length) 10.696 -0  
**\$23.00 SET** ⚠️

**Door Glass Setting Bulk**



**4074657BULK^ .37-38**  
U-channel. Sold by the inch 10.696 -0.3  
**\$0.25 IN** ⚠️

**4598678BULK^.....49-57**  
Glass setting channel - rubber sold by the inch 10.696 -0  
**\$0.25 IN** ⚠️

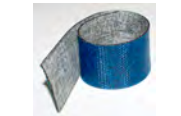

**603955BULK^....ALL**  
Setting tape 1/16 in. thick sold by the inch 10.696 -0.3  
**\$0.25 IN** ⚠️

**Door Glass Frame**

**4560812.....49-52**  
Chrome, right, fits Hardtop & Convertible 10.689 -0.15  
**\$148.75 EA** ⚠️

**4560813.....49-52**  
Chrome, left, fits Hardtop & Convertible 10.689 -0.15  
**\$148.75 EA** ⚠️

**4601066.....53-54**  
Chrome, right, fits Hardtop & Convertible 10.689 -0.15  
**\$122.25 EA** ⚠️

**4601067.....53-54**  
Chrome, left, fits Hardtop & Convertible 10.689 -0.15  
**\$122.25 EA** ⚠️

**Adhesives And Sealers**



**306105.....ALL**  
Super Glue Gel. Bonds to ABS, Ceramic, cork, G10 Epoxy Glass, Leather and paper. Splice window gaskets & sponge weather strip & more. 8.800 -0.15  
**\$3.50 EA** ⚠️



**306106.....ALL**  
LOCTITE Super Glue, Ultra Gel Control. Bonds to Metal, Rubber, Ceramics, Wood, Leather, Paper & Plastics. Rubber to metal & rubber to rubber bonding. Splice window gaskets & sponge weather strip & more. 8.800 -0.15  
**\$6.00 EA** ⚠️

**Odds And Ends**

Please call for availability on all Odds & Ends parts. Once part is sold, it may no longer be in stock.

**4105725.....40**  
Moulding reveal, fits 2 door Town Sedan left side, used in good condition 10.707 -0.4  
**\$40.00 EA** ⚠️

**4125713U.....41-47**  
Moulding reveal, fits 2 door Aerosedan left side, used in good condition 11.031 -0.4  
**\$35.00 EA** ⚠️

**4114327.....41-48**  
Window regulator right front fits 4 door & Sedan Delivery 32.000 -0.4  
**\$75.00 EA** ⚠️

**4147563.....41-48**  
Vent assembly. Right side. Fits 4-door, exc WGN & CBL 10.655 -0.4  
**\$40.00 EA** ⚠️

**4162525U.....48**  
Moulding reveal, fits coupe, used in good condition 10.707 -0.4  
**\$140.00 EA** ⚠️

**4173479.....49-52**  
Vent Window Frame Lower Pivot, Front 32.000 -0.4  
**\$15.00 EA** ⚠️

**4173480.....49-52**  
Vent Window Frame Lower Pivot, Rear 32.000 -0.4  
**\$15.00 EA** ⚠️

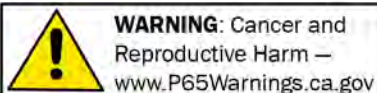

**WARNING: Cancer and Reproductive Harm** — www.P65Warnings.ca.gov

Chemicals shipped domestic ground only (Lower 48 states only). No international shipping.

**Phone: (360) 816-0211 • (800) 999-CHEV (2438) • www.chevsofthe40s.com**



**SECTION 452C  
RESTORATION PARTS**

**Glass Quarter Setting Bulk**

**40828210BULK^.....37-54**

Glass setting channel - rubber sold by the inch 10.696 -0 ..... **\$0.50 IN** ⚠

**01C201PL.....53-54**

Fits wagon. Sold by the foot 10.000 -0.15 ..... **\$3.50 FT** ⚠

**603955BULK^.....ALL**

Setting tape 1/16 in. thick sold by the inch 10.696 -0.3 ..... **\$0.25 IN** ⚠

**Garnish Clips**

**4090876.....39**

This u-clip is for the garnish moulding bottom support for Deluxe Master Sedan and Deluxe Master Coupe. 11.133 -0.3 ..... **\$5.50 EA** ⚠

**4112927.....40-48**

Garnish moulding bottom support u-clips (exc Cabriolet, Fleetline 4-door & wagon) 11.133 -0.3 ..... **CALL** ⚠

**4112927.....49-57**

Garnish moulding bottom support u-clips quarter on 2-door Sedan & 49-52 Coupe 11.133 -0.3 ..... **CALL** ⚠

**Quarter Window Rubber**



**4089553.....35-38**

Coupe 11.015 -0.15 ..... **\$139.25 SET** ⚠

**4076989.....37-38**

4-door opening window, Master 10.992 -0.15 ..... **\$127.75 PR** ⚠

**4076989A.....37-38**

4-door opening window, Master Deluxe & Sport Sedan 10.992 -0.15 ..... **\$145.00 PR** ⚠

**4089553A.....37-38**

4-door fixed window 11.015 -0.3 ..... **\$87.00 SET** ⚠

**4090190.....39**

Business Coupe 11.015 -0 ..... **CALL** ⚠

**4090190E.....39**

Business Coupe. 11.015 -0.15 ..... **\$146.75 PR** ⚠

**Quarter Window Rubber, cont.**

**4090831.....39**

4-door fixed window 11.015 -0.15 ..... **\$136.75 SET** ⚠

**4102336.....40**

Coupe & 4-door 11.015 -0.15 ..... **\$199.25 SET** ⚠

**4114993.....41-48**

4-door w/ fixed window 11.015 -0.15 ..... **\$190.75 SET** ⚠

**4114992.....41-52**

Coupe w/ fixed window 11.015 -0 ..... **CALL** ⚠

**4114992E.....41-52**

Coupe w/ fixed window 11.015 -0.15 ..... **\$183.00 SET** ⚠

**4597180.....53**

Coupe w/ fixed window 11.015 -0.15 ..... **\$169.00 PR** ⚠

**4603465.....53**

Station Wagon w/ fixed window 11.015 -0.15 ..... **\$173.00 PR** ⚠

**4644350.....54**

2 door Utility Sedan w/ fixed window 11.015 -0 ..... **\$170.50 PR** ⚠

**Bowdrill**

**4132245T.....ALL**

Cloth (black) 3 ft x 1 ft for roof rail weather strip, quarter window vertical seal & back of windshield post weatherstrip. 10.721 -0.15 ..... **\$6.00 SET** ⚠

**Quarter Glass Frame**

**4628626.....53-54**

Chrome for upper right on Convertible 11.024 -0.15 ..... **\$115.25 EA** ⚠



**4628627.....53-54**

Chrome for upper left on Convertible 11.024 -0.15 ..... **\$115.25 EA** ⚠

**Vertical Rubber**

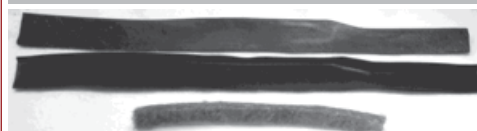

**4114958.....39-53**

W/ felt seals. Front of sliding quarter glass. Coupe & Sedans (4 pcs). 11.015 -0.15 ..... **\$93.75 SET** ⚠

**4114959.....39-53**

11.015 -0.15 ..... **\$87.00 PR** ⚠



**Windshield Post Weatherstrip**

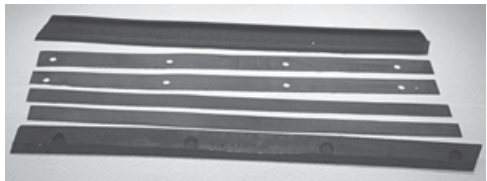

**4115230.....40-48**

Windshield post to vent frame w/ original cloth cover Cabriolet (also see 4115230B) 10.720 -0.15 ..... **\$56.00 SET** ⚠



**4589965B.....49-52**

Windshield post to vent frame-Convertible 14.115 -0.15 ..... **\$160.50 L&R** ⚠

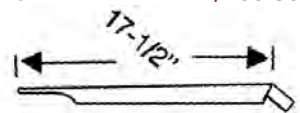

**4610963.....52**

Windshield post to vent frame-Hardtop 14.115 -0.15 ..... **\$221.00 PR** ⚠

**Channel Kit Components**

Note: Components are included in channel kits and available separately.

**4072911.....37-38**

Window anti-rattle bumpers (4 pcs) 11.139 -0.4 ..... **\$3.00 SET** ⚠

**4011688.....37-40**

Window stop bumper, lower. Fits 2-door sedan 10.716 -0.15 ..... **\$5.00 PR** ⚠

**4075477.....37-54**

Flex channel with stainless steel bead 96" 20.000 -0.15 ..... **\$46.25 EA** ⚠

**4102157.....37-54**

Narrow sweeper with stainless steel bead, sold by the inch 20.000 -0.3 ..... **\$0.50 IN** ⚠

**4099318.....40-52**



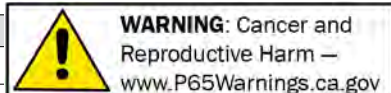

Window stop sliding quarter window 10.263 -0.15 ..... **\$6.00 PR** ⚠

**4131052.....41-57**

Window stop bumper, lower (exc. Hardtop & Convertible) 10.716 -0.15 ..... **\$4.00 PR** ⚠



**Channel Kit Components, cont.**

-  **4131772.....42-52**  
Stop on guide, upper, Hardtop & Convertible  
11.013 -0.4 .....  
**\$5.75 PR** ⚠
-  **4132055.....42-52**  
Stop on guide, lower, Hardtop & Convertible  
11.013 -0.4 .....  
**\$4.25 PR** ⚠
-  **4131898A.....42-60**  
Seal. Leading edge of quarter glass. Metal core with cloth. Cabriolet. 11.015 -0.15 .....  
**\$56.00 PR** ⚠
-  **4131898.....42-62**  
Seal & Bowdrill Cloth Front of quarter glass. Fits Hardtop & Convertible. 11.015 -0.15 .....  
**\$42.75 PR** ⚠
-  **CC-22.....ALL**  
Black mohair lining material with rubber backing, sold by the foot 10.000 -0.15 .....  
**\$16.00 FT** ⚠

**Glass Quarter Setting Kit**

Note: Includes correct rubber channel with flanges for bottom of glass & filler for chrome frames as needed.

-  **4082810Q.....37-54**  
Roll-up, 2-door sedan (72in. length) 10.696 -0 .....  
**\$29.00 SET** ⚠
-  **603953Q48.....39-48**  
Sliding, 4-door (52in. length) 10.696 -0.15 .....  
**\$7.50 SET** ⚠
-  **603953Q54.....39-54**  
Sliding. Fits Coupe (48 in. length) 10.696 -0.15 .....  
**\$4.75 SET** ⚠
-  **603953Q53.....42-54**  
Fits Convertible & Hardtop (120 in. length) 10.696 -0.15 .....  
**\$11.75 SET** ⚠

**SECTION 455C RESTORATION PARTS**

**Screw Set**

-  **4141509.....40-50**  
Convertible back glass frame (16 pcs)  
13.395 -0.4 .....  
**\$5.00 SET** ⚠

**Moulding Bolts And Nuts**

-  **4582941.....50-52**  
Back glass divider (Hardtop) 11.216 -0.4 .....  
**\$20.00 SET** ⚠

**Reveal Moulding Clips**

-  **4571696.....50-52**  
Under back glass. Fits hardtop. (Uses 8). 11.209 -0 .....  
**CALL** ⚠

- 4571696S.....50-52**  
Under back glass. Fits hardtop. Stainless (Set of 8). 11.209 -0 .....  
**\$74.75 SET** ⚠

-  **4571697.....50-52**  
Above back glass. Fits hardtop. (12 pcs) 11.209 -0 .....  
**CALL** ⚠

- 4571697S.....50-52**  
Above back glass. Fits hardtop. Stainless (12 pcs) 11.209 -0 .....  
**\$114.75 SET** ⚠

**Back Glass Rubber**

-  **4046290.....36-39**  
Sedan delivery 11.187 -0.15 .....  
**\$159.75 EA** ⚠
-  **4073972E.....37-40**  
Except Sedan Delivery 11.207 -0.15 .....  
**\$147.00 EA** ⚠
-  **4102339.....40-48**  
Sedan Delivery 11.187 -0.15 .....  
**\$140.50 EA** ⚠
- 4114861A.....41-48**  
Pinch-weld-back glass, retains moulding, use with #4125388 & #4125209 (8 ft) 10.097 -0 .....  
**\$30.00 EA** ⚠

-  **4114979.....41-48**  
Coupes, Sedan w/out moulding 11.207 -0.15 .....  
**\$158.00 EA** ⚠

- 4125388.....41-48**  
Coupe, Sedan w/ moulding, needs #4114861A 11.207 -0 .....  
**CALL** ⚠

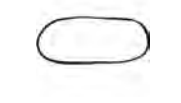
-  **4125388E.....41-48**  
Coupe, Sedan w/ moulding, needs #4114861A 11.207 -0.15 .....  
**\$180.00 EA** ⚠

**Back Glass Rubber, cont.**

-  **4125209.....42-48**  
Fleetline 2-door, needs #4114861A 11.207 -0.15 .....  
**\$180.00 EA** ⚠

-  **4162630.....46-54**  
Wagon tailgate 12.180 -0.15 .....  
**\$113.00 EA** ⚠

- 4564356.....49-52**  
Styleline Special, 2 & 4-door sedans w/ out moulding 11.207 -0.3 .....  
**\$110.50 EA** ⚠

-  **4564356E.....49-52**  
Styleline Special, 2 & 4-door sedans w/out moulding 11.207 -0 .....  
**\$158.00 EA** ⚠

-  **4564357.....49-52**  
Styleline Deluxe, 2- & 4-door sedan w/ moulding 11.207 -0.15 .....  
**\$173.25 EA** ⚠

- 4564358E.....49-52**  
Fleetline Deluxe, 2- & 4-door w/ moulding 11.207 -0.15 .....  
**\$156.25 EA** ⚠

- 4564359.....49-52**  
Styleline Special Coupe w/out moulding 11.207 -0 .....  
**CALL** ⚠

- 4564359E.....49-52**  
Styleline Special Coupe w/out moulding 11.207 -0.15 .....  
**\$157.25 EA** ⚠

- 4564360.....49-52**  
Styleline Deluxe Coupe w/ moulding 11.207 -0.15 .....  
**\$139.75 EA** ⚠

-  **4564360E.....49-52**  
Styleline Deluxe Coupe w/ moulding 11.207 -0.15 .....  
**\$170.00 EA** ⚠

- 4570888.....49-52**  
Fleetline Special, 2- & 4-door w/out moulding 11.207 -0 .....  
**\$65.00 EA** ⚠

- 4564672.....49-54**  
Sedan Delivery w/ moulding 11.187 -0.15 .....  
**\$158.00 EA** ⚠

-  **4592650.....50-52**  
Bel Air, Hardtop 11.207 -0.15 .....  
**\$712.00 EA** ⚠

- 4597457.....53**  
210 Club Coupe. 11.207 -0.15 .....  
**\$196.00 EA** ⚠

- 4633111.....53**  
150 Coupe, 2 & 4 door without moulding. 11.207 -0.05 .....  
**\$183.50 EA** ⚠

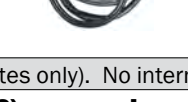
-  **4616107.....53-54**  
Bel Air, 210, 2 & 4 door with moulding. 11.207 -0 .....  
**CALL** ⚠

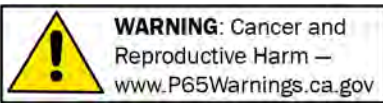



Chemicals shipped domestic ground only (Lower 48 states only). No international shipping.

Phone: (360) 816-0211 • (800) 999-CHEV (2438) • www.chevsofthe40s.com



**Back Glass Rubber, cont.**

-  **4616107E.....53-54**  
Bel Air, 210, 2 & 4 door with moulding. 11.207 -0.15 .....  
**\$180.00 EA** ⚠
-  **4620102.....53-54**  
Bel Air Hardtop. 11.207 -0 ..... **CALL** ⚠
- 4620102E.....53-54**  
Bel Air Hardtop. 11.207 -0.15 **\$203.75 EA** ⚠
-  **4641068.....54**  
150 2 & 4 door without moulding. 11.207 -0.15 ..... **\$178.75 EA** ⚠

**SECTION 460C  
STREET ROD PARTS**

**Power Window Conversion**



- 3657494.....37-54**  
Chevy Car. Complete kit does 2 doors, requires some modification to fit. 16.180 -0.15 ..... **\$500.00 SET** ⚠

**Window Crank Switch**



- NU-CRANKS12....ALL**  
Use your original crank handles as your switches. GM 1949 & earlier, small round spline. Pair. -0.15 ..... **\$280.00 PR** ⚠

spline. Pair. -0.15

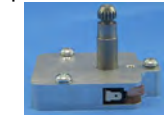

- NU-CRANKS13....ALL**  
Use your original crank handles as your switches. GM 1950 & later, large round spline, long shaft. Pair. -0.15 ..... **\$280.00 PR** ⚠

long shaft. Pair. -0.15

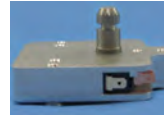

- NU-CRANKS14....ALL**  
Use your original crank handles as your switches. GM 1950 & later. Large round spline, short shaft. Pair. -0.15 ..... **\$280.00 PR** ⚠

spline, short shaft. Pair. -0.15

- NU-CRANKSU.....ALL**  
Use your original crank handles as your switches. Upgrade to power window kit only -0.15 ..... **\$264.75 PR** ⚠

**Power Window Conversion Gear Driven Bolt In**

These kits directly bolt into original mounting holes. 1018 cold rolled steel, brass oilite thrust bearings, Delco OEM Motors and gear teeth cryogenically treated for long life. Includes Delco OEM Chrome or Illuminated switches, conduit for wiring & lifetime warranty.



- 3657495.....37-39**  
2 door, front doors only. Also fits Pontiac 16.180 -0.15 ..... **\$534.75 PR** ⚠
- 3657495V.....37-39**  
Power window conversion, 2DR coupe - for removed vent windows, front doors only. Modification required -0.15 ..... **\$704.25 PR** ⚠

**Power Window Conversion Gear Driven Bolt In, cont.**

- 3657495V1.....37-39**  
Chevy 2DR sedan power window conversion. Front doors only, for removed vent windows. Modification required -0.15 ..... **\$704.25 PR** ⚠
- 3657496.....40-48**  
Power window conversion. Bolt in, gear drive, 2DR 16.180 -0.15 ..... **\$534.75 PR** ⚠
- 3657496V.....40-48**  
Chevy 2DR coupe power window conversion. Front doors only, for removed vent windows. Modification required -0.15 ..... **\$704.25 PR** ⚠
- 3657496V1.....40-48**  
Chevy 2DR sedan power window conversion. Front doors only, for removed vent windows. Modification required -0.15 ..... **\$704.25 PR** ⚠
- 3657497.....49-52**  
Power window conversion. Bolt in, gear drive, 2DR 16.180 -0.15 ..... **\$534.75 PR** ⚠
- 3657497A.....49-52**  
4-door. 16.180 -0.15 ..... **\$1,691.00 SET** ⚠
- 3657497B.....49-52**  
Sedan Delivery 16.180 -0.15 ..... **\$535.00 PR** ⚠
- 3657497HC.....49-52**  
Chevy 2DR hardtop & convertible power window conversion. Front doors & rear quarter. -0.15 ..... **\$1,331.50 SET** ⚠
- 3657498.....53-54**  
Power window conversion. Bolt in, gear drive, All 2 door including hardtop and convertible (exc sedan delivery). 16.180 -0.15 ..... **\$534.75 PR** ⚠
- 3657498A.....53-54**  
4-door. 16.180 -0.15 ..... **\$1,330.00 SET** ⚠
- 3657498AF.....53-54**  
4-door front doors only and sedan delivery. 16.180 -0.15 ..... **\$535.00 SET** ⚠
- 3657498HC.....53-54**  
Chevy hardtop & convertible power window conversion. Front doors & rear quarter. -0.15 ..... **\$1,330.00 SET** ⚠

**SECTION 460C  
RESTORATION PARTS**

**Window Regulator**

- 4059867A.....29-39**  
Spring -Window Regulator Clutch 10.783 -0 ..... **CALL** ⚠



- 4102309A.....40-48**  
Spring -Window Regulator Clutch 10.783 -0.2 ..... **\$4.00 EA** ⚠

**Spring And Pin**

- 4073926.....37-39**  
Window regulator 10.783 -0 ..... **CALL** ⚠



# Section 460C: Window Crank, Window Regulator & Power Window Kits

## Screws



**431791B.....41-48**  
Slotted pan head w/ lock washer. Attaches window regulator & interior door handle

remote to door (22 pcs). 10.791-0.3

**\$22.00 SET** ⚠️

## Roller And Rivet

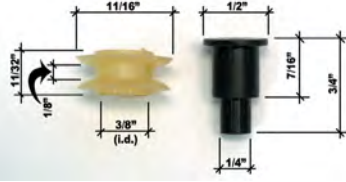

**3847281.....37-57**

For slot in window channel. Window regulator. 1/4" See part 3847282 37-57(37-48 needs modification)

10.716-0.4 ..... **\$1.75 EA** ⚠️

**3847282.....37-57**

For slot in window channel. Window regulator 5/16" 10.716-0

..... **\$5.75 EA** ⚠️

## Metal Sash Channel



**4561136.....37-54**

24in. length w/ 2 brackets (glass support). Sash channel only, modify to fit your cam track, using your original channel as a guide. 10.747-0.2

..... **\$130.50 L&R** ⚠️

## Escutcheon

Note: Concourse quality matches stock color



**4073966.....37-38**

Fits door handle.

Chrome 10.805-0

..... **CALL** ⚠️



**4073996.....37-38**

Fits vent & window handles. Chrome

10.805-0.15

..... **\$12.00 EA** ⚠️



**4090160.....39**

Fits door & window handles. Rose tan.

Concourse Quality.

10.805-0

..... **\$12.00 EA**



..... **\$12.00 EA**

**4090160E.....39**

Fits door & window handles. Ivory

10.805-0.4

..... **\$14.00 EA** ⚠️

## Escutcheon, cont.



**4090161.....39**

Fits door & window handles. Brown (JB)

10.805-0.15

..... **\$13.75 EA** ⚠️



**4102256.....40**

Fits door & window handles. Brown (KB)

10.805-0

..... **CALL** ⚠️



**4102302.....40**

Fits door & window handles. Brown/ ivory

10.805-0.15

..... **\$12.00 EA** ⚠️



**4116127.....41**

Fits door & window handles. Original ivory

w/ chrome ring.

Concourse quality.

10.805-0.4

..... **\$12.00 EA** ⚠️

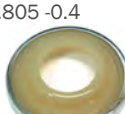

**4116127E.....41**

Fits door & window handles. Ivory w/ chrome ring

10.805-0.3

..... **\$7.00 EA** ⚠️



**4116600A.....42**

Fits door & window handles. Brown w/ chrome ring

10.805-0.15

..... **\$16.50 EA** ⚠️



**4146889.....46-48**

Fits door & window handles. Ivory w/ chrome ring

10.805-0.15

..... **\$14.00 EA** ⚠️

## Disk Behind Interior Handles



**4659983.....49-57**

Set of 2 10.805-0.15

..... **\$4.00 SET** ⚠️

## Vent Crank



**4076979.....37**

Chrome w/ original black knob.

10.664-0.15

..... **\$40.00 EA** ⚠️



**4082071.....38**

W/ original ivory knob

10.664-0.15

..... **\$40.00 EA** ⚠️



**4090164.....39**

W/ rose tan knob

10.664-0

..... **\$45.25 EA** ⚠️



**4090165.....39**

W/ original brown knob (JB)

10.664-0

..... **\$40.00 EA** ⚠️

## Vent Crank, cont.



**4102300.....40**

W/ original ivory knob

10.664-0

..... **CALL** ⚠️



**4102300C.....40**

W/ Chrome Knob

10.664-0

..... **CALL** ⚠️

**4102300E.....40**

W/ Ivory Knob 10.664-0

..... **CALL** ⚠️



**4102824.....40**

W/ original brown knob (KB) Original color and quality.

10.664-0.4

..... **\$35.00 EA** ⚠️

**4116130.....41-48**

W/ original copper swirl knob. Original color and quality.

10.664-0

..... **CALL** ⚠️



**4116130E.....41-48**

W/ original copper swirl knob economy grade.

10.664-0.3

..... **\$26.00 EA** ⚠️

**4116130EP....41-48**

W/ original copper swirl knob economy grade.

10.664-0.2

..... **\$12.50 EA** ⚠️

**4619386.....49-57**

W/ black knob-chrome insert. Correct for 53-57 series 1000 series 2000 no insert



..... **\$8.00 EA** ⚠️

**4619386A.....49-57**

W/ black knob-superior quality. Correct for 53-57 series 1000 series 2000 no insert



10.664-0.15

..... **\$15.75 EA** ⚠️

**4619386C.....49-57**

W/ chrome knob

10.664-0.2

..... **\$11.25 EA** ⚠️



**461938B.....51-52**

W/ original ivory knob

10.664-0

..... **CALL** ⚠️

**461938B.....51-52**

W/ original ivory knob

10.664-0

..... **CALL** ⚠️

## Window Crank



**4073850.....37**

W/ original black knob. (Second Quality)

10.797-0.4

..... **\$20.00 EA** ⚠️



**4082068.....38**

W/ original ivory knob

10.797-0

..... **\$43.75 EA** ⚠️

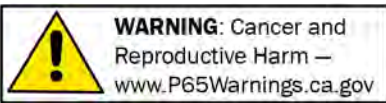

Chemicals shipped domestic ground only (Lower 48 states only). No international shipping.

Phone: (360) 816-0211 • (800) 999-CHEV (2438) • www.chevsofthe40s.com



**Window Crank, cont.**

 **4090158..... 39**  
W/ original rose tan knob 10.797 -0 .....

**\$45.50 EA** ⚠

 **4090159..... 39**  
W/ original brown knob (JB) 10.797 -0.15 ...

**\$43.00 EA** ⚠

 **4102311..... 40**  
W/ original ivory knob 10.797 -0.15 .....

**\$42.00 EA** ⚠

 **4102822..... 40**  
W/ original brown knob (KB). Original color and quality. 10.797 -0 ..

**CALL** ⚠

 **4116131..... 41-48**  
W/ original copper swirl knob. Original color and quality. 10.797 -0 ..

**CALL** ⚠

 **4116131EP .... 41-48**  
W/ original copper swirl knob 10.797 -0.15 ..

**\$11.00 EA** ⚠

 **4564255..... 49**  
W/ original ivory knob-includes disk behind handle

#4659983 10.797 -0 ..... **CALL** ⚠

 **3703831..... 49-57**  
W/ black knob, chrome insert. Correct for 53-57 series 1000 series

2000 no insert. 10.797 -0.2 **\$16.75 EA**

 **3703831C..... 49-57**  
Chrome w/ chrome knob. Includes clip. 10.797 -0.2 .....

**\$15.75 EA** ⚠

 **4582152..... 50**  
W/ dark Grey knob. Chrome insert. Includes clip & disk behind

handle (#4659983). 10.797 -0 .. **CALL**

 **3703835..... 51-52**  
With original ivory knob-includes clip & disk behind handle

#4659983 (exc Wagon) 10.797 -0.15 ..

**\$13.75 EA** ⚠

**Horseshoe Clips**

 **4090144..... 39-48**  
Retains inside handles (10 pcs) 10.513 -0.4 .....

**\$2.25 SET** ⚠

 **4168122..... 49-57**  
Retains inside handles (10 pcs) 10.513 -0.4 .....

**\$2.75 SET** ⚠

**Tool**



**3703632C ..... 39-48**  
Removes horseshoe clips-interior handle 10.511 -0.3 .....

**\$17.00 EA** ⚠

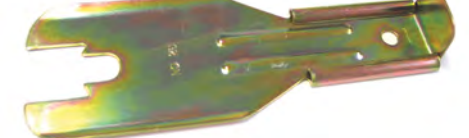

**3703632A ..... 49-57**  
Removes horseshoe clips-interior handle. 10.511 -0.2 .....

**\$5.75 EA** ⚠

**Knob**

Note: Concourse quality matches stock color

 **4073850A..... 37**  
Window or vent crank-black w/ chrome center 10.797 -0.15 .....

**\$18.00 EA** ⚠

 **4082068A ..... 38**  
Window or vent crank. Ivory 10.797 -0.4 .....

**\$14.00 EA** ⚠

 **4090158A ..... 39**  
Window or vent crank. Rose tan. Concourse quality. 10.797 -0.4 .....

**\$14.00 EA** ⚠

**4090158E ..... 39**  
Window or vent crank. Rose tan 10.797 -0.2 .....

**\$7.25 EA** ⚠

 **4090159A ..... 39**  
Window or vent crank. Brown (JB) 10.797 -0.15 .....

**\$15.00 EA** ⚠

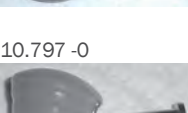
 **4102311A..... 40**  
Window or vent crank. Brown (KB) Original color and quality. ....

**CALL** ⚠

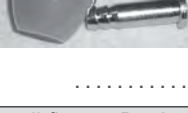
 **4146766A..... 40**  
Window or vent crank. Ivory. Original color and quality. 10.797 -0.15 .....

**\$10.00 EA** ⚠

**Knob, cont.**

 **4147120A..... 41-48**  
Window or vent crank. Copper swirl center-Concourse Quality. 10.797 -0.15 .....

**\$14.00 EA** ⚠

 **4147120E..... 41-48**  
Window or vent crank. Copper swirl center. Color variance. 10.797 -0.3 .....

**\$7.50 EA** ⚠

 **3703835A..... 51-52**  
Window or vent crank. Ivory w/ chrome post. Original color and

quality. 10.797 -0 .....

**CALL** ⚠

**Odds And Ends**

Please call for availability on all Odds & Ends parts. Once part is sold, it may no longer be in stock.

**4110672U ..... 41-48**  
Window regulator used (right rear window) fits all except Fleetline 10.791 -0

**\$55.00 EA** ⚠

**4116130U ..... 41-48**  
Vent crank w/ knob (Used) 10.664 -0.4 ...

**\$7.00 EA** ⚠

**3703831CU ..... 49**  
Window crank w/ ivory knob (Used) 10.794 -0 .....

**\$5.00 EA** ⚠

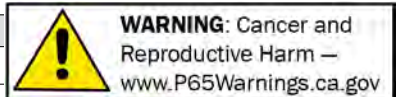



15.294  
1941-48 COUPE  
TRUNK FLOORMAT

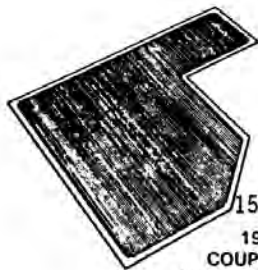

15.294  
1941-48  
COUPE TOP  
LUGGAGE MAT

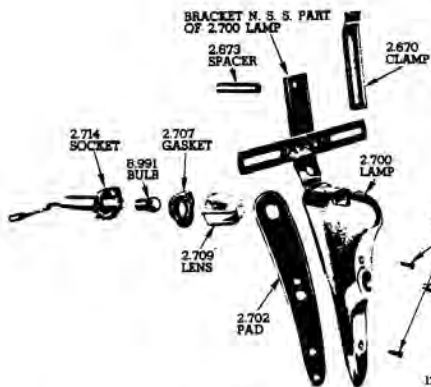

1941-48 REAR COMPARTMENT  
LOCKING HANDLE

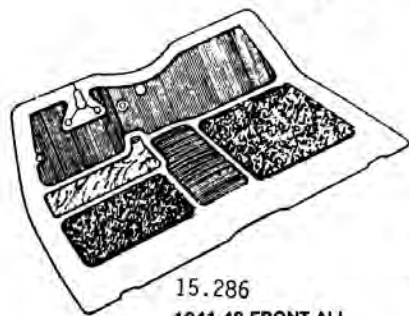

15.286  
1941-48 FRONT ALL



15.294  
1941-48 ALL SED.

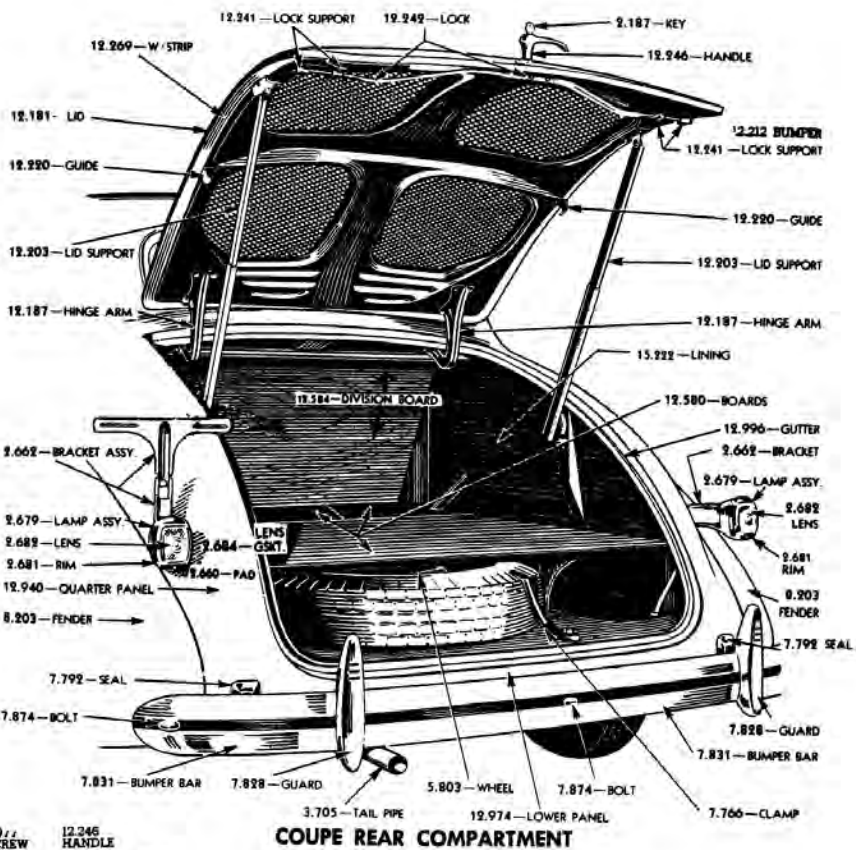

COUPE REAR COMPARTMENT

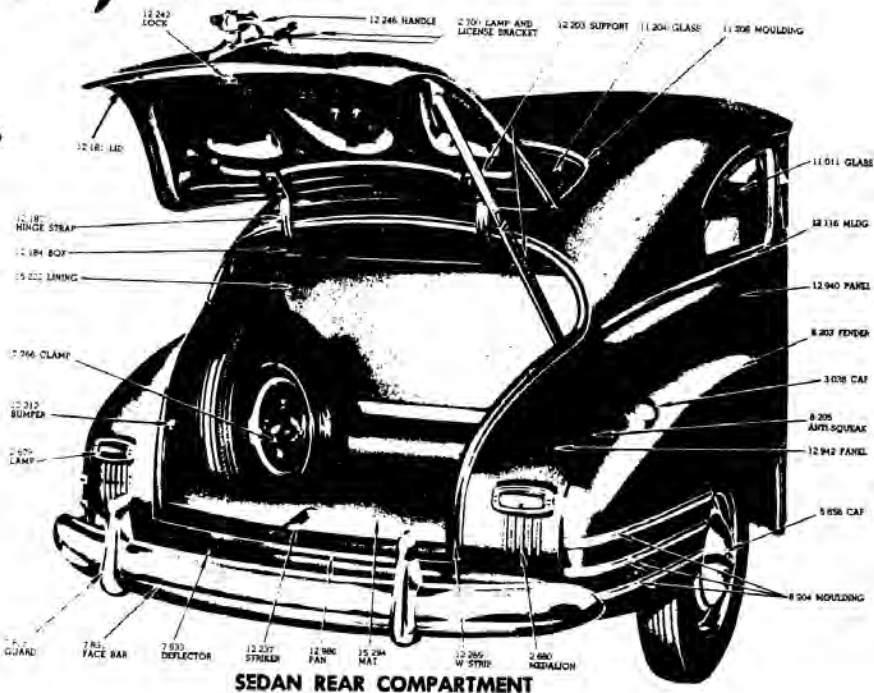

SEDAN REAR COMPARTMENT



**WARNING:** Cancer and  
Reproductive Harm —  
[www.P65Warnings.ca.gov](http://www.P65Warnings.ca.gov)

Chemicals shipped domestic ground only (Lower 48 states only). No international shipping.  
**Phone: (360) 816-0211 • (800) 999-CHEV (2438) • [www.chevsofthe40s.com](http://www.chevsofthe40s.com)**



**SECTION 490C  
STREET ROD PARTS**

**Liftgate Latch**



**4605784A** ..... **49-54**  
Liftgate latch (exc  
6-pass handyman  
1062F) 12.246-0 .....  
**\$250.00 EA** ⚠

**Trunk Handle**

**3692500** ..... **49-54**  
Chrome "T" Handle Comes With Lock and  
2 Keys 12.246-0 ..... **\$275.00 EA** ⚠

**Trunk Lid Fiberglass**

Note: Our fiberglass trunk lids are steel framed  
and assembled. Yet another example of our  
effort to provide the best products we can to  
our customers.

**4083385** ..... **37-38**  
Sedan. 12.181-0.15 ..... **\$955.00 EA** ⚠  
**4083385F** ..... **37-38**  
Sedan, frenched license pocket.  
12.181-0.15 ..... **\$955.00 EA** ⚠  
**4084781** ..... **37-38**  
Coupe. 12.181-0.15 ..... **\$871.25 EA** ⚠  
**4084781F** ..... **37-38**  
Coupe, frenched license pocket.  
12.181-0.15 ..... **\$955.00 EA** ⚠

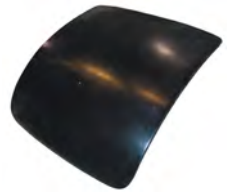

**4091434** ..... **39**  
Coupe. 12.181-0.15 ..... **\$951.00 EA** ⚠  
**4091434F** ..... **39**  
Coupe, frenched license pocket.  
12.181-0.15 ..... **\$975.00 EA** ⚠  
**4103252** ..... **40**  
Coupe. 12.181-0 ..... **CALL** ⚠  
**4103252F** ..... **40**  
Coupe, frenched license pocket. 12.181-0  
..... **CALL** ⚠  
**4113911** ..... **40**  
Sedan. 12.181-0 ..... **CALL** ⚠  
**4147955** ..... **41-48**  
Coupe. 12.181-0.15 ..... **\$858.00 EA** ⚠  
**4147955F** ..... **41-48**  
Coupe with frenched license pocket.  
12.181-0 ..... **CALL** ⚠

**SECTION 490C  
RESTORATION PARTS**

**Liftgate Latch**



**4605784R** ..... **49-54**  
Liftgate latch repair kit  
(exc 6-pass handyman  
1062F) 12.246-0 .....  
**\$214.00 EA** ⚠

**License Bracket**



**604288** ..... **39-48**  
License plate-39 on  
trunk and 40-48 Sedan  
Delivery on back door  
..... **\$45.00 EA** ⚠  
2.662-0.15

**Trunk Handle**



**4074026** ..... **37**  
Vertical locking pin  
12.246-0.15 ..... **CALL**  
⚠

**4274026** ..... **37**  
Horizontal locking pin 12.246-0 ..... **CALL**  
⚠



**4090230A** ..... **38-39**  
Coupe. 1-3/8" Shaft. Vertical lock pin.  
12.246-0.15 ..... **\$125.00 EA** ⚠



**4102368** ..... **40**  
Without lock cylinder. 1-1/4" shaft,  
3-23/32" overall length (lock to shaft  
end). 12.246-0 ..... **CALL** ⚠  
**4125645** ..... **42-48**  
12.246-0 ..... **CALL** ⚠  
**4125645A** ..... **42-48**  
12.246-0 ..... **CALL** ⚠

**Trunk Hold Up**



**4082889** ..... **38-39**  
(telescopic) Sedan-zinc  
Plated 12.203-0 ..... **\$268.75 EA** ⚠

**Trunk Emblem And Script**



**595744** ..... **37**  
Sedan 12.301-0.15 ..... **\$95.75 EA** ⚠  
**597496** ..... **38**  
Sedan 12.301-0.15  
..... **\$95.75 EA** ⚠

**4129243B** ..... **41-48**  
Fleetline 12.182-0.3  
..... **\$39.00 EA** ⚠

**3663925B** ..... **42-46**  
Wings on the side of the  
License bracket, trunk  
handle assembly.  
2.704-0.15 ..... **\$450.00 L&R** ⚠

**Trunk Emblem And Script, cont.**



**3664044** ..... **42-48**  
Chevrolet. 8-1/4" x 1-1/2" 12.182-0  
**CALL** ⚠



**3693353S** ..... **50**  
Trunk spears (sides of trunk handle),  
manual transmission. Chrome. Driver  
quality. Not as original. 12.182-0 ..... **CALL**  
⚠



**3702729** ..... **53**  
Plastic 12.246-0.15 ..... **\$43.25 EA** ⚠



**3705031** ..... **54**  
Plastic 12.246-0.15 ..... **\$54.75 EA** ⚠



**3705031B** ..... **54**  
Plastic w/ chrome bezel 12.246-0.15  
..... **\$99.25 EA** ⚠



**3707970** ..... **54**  
Chevrolet.  
13-1/4" x 1". 12.182-0.15 ..... **\$25.00 EA**  
⚠



**3707971** ..... **54**  
Powerglide 12.182-0.15 ..... **\$23.00 EA** ⚠

Returns require a return authorization number—call first. • Product pricing & availability subject to change.

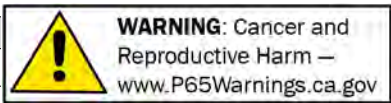

**Trunk Emblem Pad**



**595744A**..... **37**  
Sedan (not originally used) 12.301-0.15  
..... **\$15.00 EA** ⚠



**597496B**..... **38**  
Sedan (not originally used) 12.301-0.15  
..... **\$12.00 EA** ⚠



**3662998** ..... **53**  
Sedan (not originally used) 12.246-0.15  
..... **\$40.25 EA** ⚠

**Decal**



**4170868D**..... **50**  
Trunk handle housing (2 piece set). 12.247-0.15  
..... **\$21.50 SET** ⚠

**Retainer Clips And Screws**



**827925**..... **39**  
Lens retainer clips & screws. 2.691-0.15  
..... **\$15.00 SET** ⚠



**827925**..... **40-48**  
Lens retainer clips & screws, SDL, back door. 2.691-0.15  
..... **\$15.00 SET** ⚠

**License Light Medallion**



**599642**..... **39**  
Medallion face of license light housing. 2.704-0.15  
..... **\$99.00 EA** ⚠

**License Light Lens**



**923386**..... **39**  
Lens, Trunk Mount 2.709-0.3  
..... **\$20.00 EA** ⚠

**5930151** ..... **40-41**  
License light lens cover "only" chrome. 2.706-0.3  
..... **\$16.00 EA** ⚠



**922042**..... **40-41**  
License Light Lens (exc Sedan Delivery & Station Wagon) 2.709-0.3  
..... **\$11.25 EA** ⚠



**5932761**..... **42-48**  
Lens 2.709-0.3  
..... **\$24.00 EA** ⚠

**License Light Lens, cont.**



**5940480**..... **51-52**  
Lens. 2.709-0.3  
..... **\$16.00 EA** ⚠

**License Light Lens Gasket**



**923387**..... **39**  
Lens gasket. License light. Trunk mount. 2.686-0.3  
..... **\$3.00 EA** ⚠



**923079**..... **40-41**  
Gasket for lens. 2.707-0.3  
..... **\$3.00 EA** ⚠



**5930358**..... **40-48**  
Gasket for license light lens. SDL back door. 2.686-0.2  
..... **\$3.00 EA** ⚠



**5932762**..... **42-48**  
Lens Gasket 2.707-0.15  
..... **\$2.50 EA** ⚠



**5937940**..... **49-50**  
Lens Gasket Exc Sedan Delivery & Wagon (2 pcs) 2.707-0.15  
..... **\$7.00 PR** ⚠



**5939876**..... **51-52**  
Lens Gasket 2.707-0.3  
..... **\$5.75 EA** ⚠

**5935947A** ..... **53-54**  
Cork gasket. Made in USA. Like Original 2.709-0.3  
..... **\$5.00 EA** ⚠

**Trunk Handle And License Light Pad**



**916882A**..... **39**  
Pad to trunk (not originally used) 2.702-0.15  
..... **\$14.75 EA** ⚠



**3663784**..... **39-48**  
Trunk lid & Sedan Del back door. License bracket support post pad. 2.673-0.3  
..... **\$3.75 EA** ⚠



**4089552**..... **39-48**  
Trunk lid wire grommet. 9.775-0.15  
..... **\$2.50 EA** ⚠



**411189**..... **40**  
Pad to trunk lid. 2.702-0.15  
..... **\$10.00 EA** ⚠



**3658431**..... **41**  
Pad to trunk lid. 2.702-0.15  
..... **\$16.00 EA** ⚠

**Trunk Handle And License Light Pad, cont.**



**3663703**..... **42-48**  
Pad to trunk lid (exc Fleetline 2-door). 2.702-0.15  
..... **\$22.50 EA** ⚠



**3663782**..... **42-48**  
Pad to trunk lid. Fleetline 2-door. 2.702-0.15  
..... **\$33.00 EA** ⚠



**3695023**..... **50**  
2 pcs 12.247-0.2  
..... **\$11.00 EA** ⚠

**Trunk Lock Gasket**



**4587931**..... **51-69**  
This is the trunk lock gasket for 1951-69. 12.249-0.3  
..... **\$1.00 EA** ⚠

**Trunk Lock Cylinder Spring**



**7001087**..... **51-57**  
Trunk Lock Cylinder Spring. 12.249-0.3  
..... **\$1.50 EA** ⚠

**Trunk Lock Cylinder**



**7003103A** ..... **51-57**  
W/ case, retainer clip, link rod, smooth bezel & 2 non-original keys 12.249-0.15  
..... **\$26.50 EA** ⚠



**7003103B** ..... **51-57**  
W/ case, link rod, original bezel & 2 original keys 12.249-0.15  
..... **\$24.75 EA** ⚠

**Key Blank**



**601272**..... **35-54**  
Original GM round head. Fits trunk, glove box & locking gas cap 2.187-0.2  
..... **\$5.25 EA** ⚠



**3694624**..... **35-57**  
Original GM octagon head. Fits ignition, door & spare tire locks. 2.187-0.15  
..... **\$3.75 EA** ⚠

**WARNING:** Cancer and Reproductive Harm — www.P65Warnings.ca.gov

Chemicals shipped domestic ground only (Lower 48 states only). No international shipping.

Phone: (360) 816-0211 • (800) 999-CHEV (2438) • www.chevsofthe40s.com



**Trunk Handle Ferrule**



**4003748** ..... **29-37**  
 Chrome, w/ grommet  
 10.537 -0.4 .....  
**\$7.50 EA** ⚠

**4082056** ..... **38-49**  
 Chrome, w/ grommet, exc 41-48  
 10.537 -0.2 ..... **\$15.25 EA** ⚠

**4125630** ..... **41**  
 W/ grommet 10.537 -0.4 .. **\$7.00 EA** ⚠

**606365A** ..... **42-48**  
 W/ grommet 12.247 -0.15 **\$25.50 EA** ⚠



**4088134A** ..... **ALL**  
 Installs door handle ferrules. Return tool in same condition as sent for a \$20 refund. Does not fit with 4125630  
 10.537 -0.15 ..... **\$50.25 EA** ⚠

**Rumble Seat Latch Mechanism**



**4059062** ..... **37-38**  
 Coupe MSTR DLX  
 12.242 -0.15 ..... **CALL** ⚠

**Rumble Seat Step**



**369497R** ..... **29-38**  
 Metal plate w/ threaded shaft and rubber pad without an emblem  
 9.470 -0.15 .....  
**\$56.00 EA** ⚠



**4076136A** ..... **37**  
 Rubber pad for bracket  
 15.198 -0.15 .....  
**\$11.50 EA** ⚠



**597556A** ..... **37-38**  
 Rubber pad for bracket  
 9.470 -0.15 .....  
**\$12.75 EA** ⚠

**Rumble Seat Lid Rubber Corners**

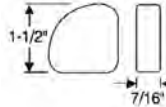

**4074031** ..... **37-38**  
 Rubber corners for the rumble seat lid to protect the lid and your passengers. 12.212 -0.15  
 ..... **\$60.00 PR** ⚠

**Trunk Hinge Washers**



**431824** ..... **35-48**  
 Cup type 12.199 -0.15  
 ..... **\$15.00 SET** ⚠

**Trunk Hinges**



**4082100** ..... **37**  
 External (chrome) sedan. Pads sold separately. 12.184 -0.15 .. **\$115.25 PR** ⚠



**4082101** ..... **38-40**  
 External (chrome). Pads sold separately. Will fit

40 Sedan but requires enlarging mounting holes. Mounting hardware not included. 12.184 -0.15 **\$110.00 PR** ⚠



**4101842** ..... **40-48**  
 Original for 41-48 Coupe (fits 40-41 Cabriolet) includes pads #4101842A  
 12.184 -0.15 ..... **\$134.00 PR** ⚠



**4107637S** ..... **42-48**  
 Fits Cabriolet. Superior quality (comes with pads) 12.184 -0 ..... **CALL** ⚠

**Trunk Hinge Gaskets**



**40821002I** ..... **37-39**  
 Rubber 12.184 -0.15  
 ..... **\$16.00 SET** ⚠



**4082100A** ..... **37-39**  
 Paper 12.184 -0.3 ..... **\$9.00 SET** ⚠  
**40821001I** ..... **40**  
 Rubber 12.184 -0.15  
 ..... **\$21.00 SET** ⚠

**Trunk Hinge Gaskets, cont.**

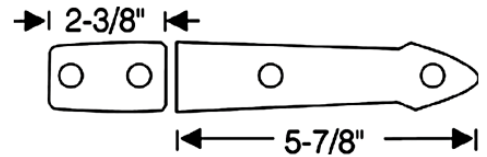

**4102348A** ..... **40**  
 Paper 12.184 -0.2 ..... **\$7.50 SET** ⚠



**4101842A** ..... **41-48**  
 Fits Coupe & 41 Cabriolet. Flat gasket (no bead on edge).  
 12.184 -0.15 .....  
**\$7.00 SET** ⚠

**\$7.00 SET** ⚠



**603956** ..... **41-48**  
 Sedan 12.184 -0.15  
**\$5.00 SET** ⚠



**4107637A** ..... **42-48**  
 Fits Cabriolet. Flat gasket (no bead on edge). 12.184 -0.2 ..... **\$7.25 SET** ⚠



**4135032A** ..... **42-48**  
 Aero 12.184 -0.2 ..... **\$7.00 SET** ⚠

**Trunk Lid Bumper**



**4074032** ..... **37-39**  
 2 screw holes. Fits Coupe exc rumble seat  
 12.212 -0 .....  
**\$30.00 PR** ⚠



**4102358** ..... **40**  
 Coupe, Cabriolet  
 12.212 -0.15 .....  
**\$57.50 PR** ⚠



**4111668** ..... **40**  
 Side of lid-Sedans  
 10.716 -0.15 .....  
**\$5.00 PR** ⚠



**4114321** ..... **41-48**  
 Round, lid side, steel core. Exc Aero (2 pcs)  
 12.212 -0.4 .....  
**\$5.50 SET** ⚠

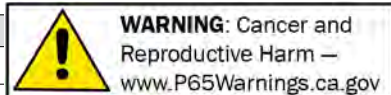

**Trunk Lid Bumper, cont.**

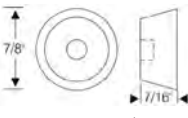
 **4137121.....42-50**  
Lid side, 42-48 Aero &  
49-50 all (2 pcs)  
9.775 -0.3 .....

**\$2.75 SET** ⚠️

 **4595786.....51-54**  
Round, lid side (2  
pieces). 12.212 -0.4  
**\$7.50 SET** ⚠️

**Hold Up Release Spring**



**4085735 .....38-40**  
Flat (3/16in. wide) 12.204 -0.15 .....

**\$17.00 EA** ⚠️

 **4121855.....41-47**  
Trunk support, coil type  
15/32" I.D. 12.204 -0.15  
..... **\$10.00 EA** ⚠️

**Trunk Latch Mechanism**

 **4059062.....29-38**  
Cabriolet 12.242 -0.15  
..... **\$90.00 EA** ⚠️

**Trunk Latch Gaskets**



**4090233A .....39**  
For side locking trunk rod guides. 3 pieces.  
12.241 -0.15 .....

**\$6.25 SET** ⚠️



**4102364A .....40**  
For side locking trunk rod guides. 4 pieces.  
12.241 -0.3 .....

**\$5.50 SET** ⚠️

**Trunk Weatherstrip**

 **4074631.....37-39**  
Coupe, Cabriolet  
12.269 -0.2 .....

**\$40.00 SET** ⚠️

 **4074631E.....37-39**  
Coupe, Cabriolet  
12.269 -0.15 .....

**\$151.00 EA** ⚠️

 **4091472.....37-39**  
Sedans 12.269 -0.15  
..... **\$107.25 EA** ⚠️

**Trunk Weatherstrip, cont.**

 **4091472E.....37-39**  
Sedans 12.269 -0.15  
..... **\$132.75 SET** ⚠️

**4131754.....40-47**  
Coupe, Cabriolet (14 ft) 12.269 -0.2 ..

**\$35.00 SET** ⚠️

**4131754A .....40-47**  
2- & 4-door sedans (12 ft) 12.269 -0.3  
..... **\$30.00 SET** ⚠️

 **4125998.....42-47**  
Fleetline 2-door  
12.269 -0.15 .....

**\$152.25 SET** ⚠️

 **4125998A .....48**  
Fleetline 2-door  
12.269 -0.15 .....

**\$34.00 SET** ⚠️

**4125998BULK.....48**  
Fleetline 2-door 12.269 -0  
..... **\$2.50 FT**  
⚠️

 **4162616.....48**  
Coupe, Cabriolet  
12.269 -0  
..... **CALL** ⚠️

 **4162616A.....48**  
Sedans 12.269 -0  
..... **CALL** ⚠️

**4162616B .....48**  
Sedans 12.269 -0.3  
..... **\$38.00 SET** ⚠️

 **4162616E.....48**  
Coupe, Cabriolet.  
12.269 -0.15 .....

**\$125.50 SET** ⚠️

**4615298 .....49-52**  
Sedans 12.269 -0.3  
..... **\$30.00 SET** ⚠️

**4615298A .....49-52**  
Hardtop, Coupe, Convertible 12.269 -0.15  
..... **\$37.00 SET** ⚠️

**4615298BULK .....49-52**  
Sold by the foot 12.269 -0.2  
..... **\$1.50 FT**  
⚠️

 **4601338.....53-54**  
2- & 4-door Sedan-  
moulded corners  
12.269 -0.15 .....

**\$45.00 SET** ⚠️

 **4601338E.....53-54**  
2- & 4-door Sedan-  
moulded corners  
12.269 -0.15 .....

**\$164.75 SET** ⚠️

**4603360 .....53-54**  
Molded corners. Fits Coupe, Convertible  
& Hardtop. 12.269 -0  
..... **CALL** ⚠️

**4603360E .....53-54**  
Molded corners. Fits Coupe, Convertible  
& Hardtop. 12.269 -0.15  
..... **\$164.75 SET**  
⚠️

**Adhesives And Sealers**

 **01608 .....ALL**  
3M plastic & emblem  
adhesive (5 oz. tube).  
8.800 -0.15 .....

**\$11.25 EA** ⚠️



**511114.....ALL**  
3M, Black weatherstrip cement, 5-oz tube.  
Superior product!. 8.800 -0.2 .....

**\$23.75 EA** ⚠️

**Tool Tray Rear of Trunk Floor**



**4111690 .....40**  
Lid (wood) for tool tray. Fits Sedan.  
12.540 -0.15 .....

**\$46.75 EA** ⚠️

**Trunk Floor Rubber Plug**

 **4124441B .....49-54**  
For spare tire well.  
9.775 -0.2 .....

**\$11.25 SET** ⚠️

 **3681751.....ALL**  
For 3/8in. hole  
9.775 -0.15 .....

**\$9.00 EA** ⚠️

 **3681751C.....ALL**  
For 1/2in. hole (2 pcs)  
9.775 -0  
..... **\$6.00 SET**  
⚠️

 **4805844.....ALL**  
For 3/4 in. hole in spare  
tire well. 9.775 -0  
.....

**\$2.25 EA** ⚠️

**Trunk Carpet Kit**

 **4591535K .....40-54**  
Cut Pile, covers the floor  
of trunk. Specify Color  
along with Year, Make &  
Model when ordering.

15.294 -0  
..... starting at **\$250.00 KIT** ⚠️

 **4591535KL .....40-54**  
Loop carpet, covers the  
floor of trunk specify  
year, model and color  
when ordering

15.306 -0.15  
..... starting at **\$265.00 KIT** ⚠️

**Trunk Floor Mat Rubber**

 **4083678.....37-38**  
Sedan. Nice  
Reproduction  
15.294 -0.15 .....

**\$146.00 EA** ⚠️

 **WARNING: Cancer and Reproductive Harm** —  
www.P65Warnings.ca.gov

Chemicals shipped domestic ground only (Lower 48 states only). No international shipping.

**Phone: (360) 816-0211 • (800) 999-CHEV (2438) • www.chevsofthe40s.com**



**Trunk Floor Mat Rubber, cont.**



**4092723..... 39**  
Sedan. Nice  
Reproduction  
15.294 -0.15 .....

**\$145.25 EA** ⚠️



**4092724..... 39**  
Coupe (exc Business  
Coupe), black. Nice  
Reproduction  
15.294 -0.15 .....

**\$145.00 EA** ⚠️



**4141515.....41-47**  
Coupe (exc Business  
Coupe). Taupe.  
15.294 -0.15 .....

**\$226.00 EA** ⚠️



**4133467.....41-48**  
Sedan and Aerosedan.  
Taupe. 15.294 -0.15 .....

**\$300.00 EA** ⚠️

**Trunk Shelf Mat**



**4076155.....37-38**  
Coupe (exc rumble seat  
& business Coupe)  
15.294 -0.15 .....

**\$145.25 EA** ⚠️



**3700154A.....41-47**  
Coupes & Convertibles.  
Taupe 15.294 -0.15 ..

**\$226.00 EA** ⚠️

**Odds And Ends**

Please call for availability on all Odds & Ends parts. Once part is sold, it may no longer be in stock.

**985601..... 40**

Trunk guard without emblem 7.828 -0.4 ..

**\$75.00 EA** ⚠️

**4101843L.....40-48**

Trunk hinge (Left). Fits 40-41 CBL &  
40-48 Coupe. 1.928 -0.4 ...

**\$15.00 EA** ⚠️

**985719..... 41**

Backup Light (NOS) Chrome 10.000 -0.4 ..

**\$300.00 EA** ⚠️



**4149870U .....41-48**  
Trunk lid sedan with  
handle, used. Has  
some surface rust -0.4 .....

**\$350.00 EA** ⚠️

**3693354 ..... 50**

Trunk lid moulding (1/2 set) for manual  
trans (Used) 12.182 -0 .....

**\$10.00 EA** ⚠️

**3694841 ..... 50**

Trunk lid moulding Power (1/2 set) for  
Powerglide trans (Used) 12.182 -0 .....

**\$30.00 EA** ⚠️

**4619753.....53-54**

BUICK HDTP Trunk Liner Press Board  
12.580 -0.2 .....

**\$70.75 SET** ⚠️

**SECTION 510C  
RESTORATION PARTS**

Note: Convertible aluminum sill plates see  
Section 290C.

Note: Body mounts & hardware see Section  
300C.

Note: Dome light see Section 330C.

Note: Door weatherstrip see Section 400C.

**Cabriolet Top Folding Instructions**



**ACC37I.....37-38**

Folding instructions, original 37 18.000 -0.15

**\$2.00 EA** ⚠️

**ACC41I..... 41**

Instruction sheet for the convertible  
folding top on a Cabriolet. 18.000 -0.15

**\$2.00 EA** ⚠️

**Convertible Top Folding  
Instructions**



**CONV46.....46-48**

Manual (every convertible had one)

18.000 -0.15 .....

**\$10.00 EA** ⚠️



**CONV49.....49-52**

Every convertible had one copy 18.000 -0.15

**\$10.00 EA** ⚠️



**CONV53..... 53**

Every convertible had one 18.000 -0

**CALL** ⚠️

**Convertible Top Folding  
Instructions**



**CONV54..... 54**

Every convertible had one 18.000 -0.15

**\$11.50 EA** ⚠️

**Convertible Top**



**4164701.....37-40**

Stayfast cloth top.  
Complete kit. Looks  
original but lasts much  
longer. Sewn to factory

specs. Comes complete w/ curtain, pads,

wire-on ends. (Specify year) Specify color:

Black/Black, Black/Tan, Dk. Blue/Black,

Med. Blue/Tan, Med. Blue/Black,

Burgundy/Black, Dk. Ruby/Black,

Driftwood/Black, Lt. Neutral/Tan, Lt.

Neutral/Black, Tan/Tan, Tan/Black, Med.

Grey/Black, charcoal/Black, Pepper/

Black, Dk. Brown/Black or Dk. Biege/

Black 15.490 -0 .....

**\$751.00 EA** ⚠️



**4164700.....37-54**

Stayfast cloth top only  
(no rear curtain). Looks  
original but lasts much  
longer. Sewn to factory

specs. (Specify year and color). 15.490 -0

.....starting at **\$435.00 EA** ⚠️

**4164704V.....40-54**

Superior double texture vinyl. Sewn to  
factory specs. (Specify year when

ordering) 15.490 -0 .....

**\$295.00 EA** ⚠️

**4164702V.....50-54**

Standard single texture vinyl. Sewn to  
factory specs (Specify year when

ordering). 15.490 -0 .....

**\$195.00 EA** ⚠️

**4164700W.....51-54**

Well for convertible top. Sewn to factory  
specs (Specify year when ordering.)

15.490 -0 .....

**\$62.00 EA** ⚠️

**4208744.....51-54**

Boot for convertible top. Looks and fits  
like factory. (Specify year when ordering.)

13.450 -0 .....

**\$125.00 EA** ⚠️

**Rear Curtain**

**4164701R40..... 40**

Curtain-rear For Cloth Top Stayfast Full  
View Clear Vinyl. -0.15 ...

**\$206.00 EA** ⚠️

**4164701RV40..... 40**

Curtain-rear For VinylTop Full View Clear  
Vinyl. -0.15 .....

**\$299.00 EA** ⚠️







## Section 510C: Special Cabriolet-Convertible Parts

### Rear Curtain, cont.

|   |              |
|---|--------------|
| <b>4164704R40</b> .....   | <b>40</b>    |
| Curtain-rear For Superior Vinyl Top For Use W/ Glass Window. -0.15 <b>\$206.00 EA</b> ⚠   |              |
| <b>4164704RS40</b> .....  | <b>40</b>    |
| Curtain-rear For Superior Vinyl Top For Use W/ Glass Window. -0.15 <b>\$266.00 EA</b> ⚠   |              |
| <b>4164701R</b> .....   | <b>40-54</b> |
| Curtain, rear for cloth top, stayfast, full view clear vinyl. Sewn to factory specs. (Specify year when ordering.) 15.490 -0.15 starting at <b>\$69.00 EA</b> ⚠ |              |
| <b>4164701R48</b> .....   | <b>42-48</b> |
| Curtain-rear For Cloth Top Stayfast Full View Clear Vinyl. -0.15 ... <b>\$206.00 EA</b> ⚠   |              |
| <b>416470R48</b> .....  | <b>42-48</b> |
| Curtain-rear For Vinyl Top Full View Clear Vinyl. -0.15 ..... <b>\$176.00 EA</b> ⚠  |              |
| <b>416472R48</b> .....  | <b>42-48</b> |
| Curtain-rear For Cloth Top Stayfast no window -0.15 ..... <b>\$266.00 EA</b> ⚠  |              |
| <b>416472V48</b> .....  | <b>42-48</b> |
| Curtain-rear For Vinyl Top no window -0.15 ..... <b>\$206.00 EA</b> ⚠   |              |
| <b>4164700R49</b> .....   | <b>49</b>    |
| Curtain-rear for cloth top. Stayfast for no window insert. -0.15 ..... <b>\$265.00 EA</b> ⚠   |              |
| <b>4164701R49</b> .....   | <b>49</b>    |
| Curtain-rear For Cloth Top Stayfast Full View Clear Vinyl. -0.15 ... <b>\$206.00 EA</b> ⚠   |              |
| <b>4164704R49</b> .....   | <b>49</b>    |
| Curtain-rear For Superior Vinyl Top For Use W/ Glass Window. -0.15 <b>\$206.00 EA</b> ⚠   |              |
| <b>4164700R52</b> .....   | <b>50-52</b> |
| Curtain-rear for cloth top. Stayfast for use w/ glass window insert. -0.15 ..... <b>\$199.50 EA</b> ⚠   |              |
| <b>4164702R52</b> .....   | <b>50-52</b> |
| Curtain, rear for Standard Vinyl Top. For use w/ Glass Window. -0.15 . <b>\$102.50 EA</b> ⚠   |              |
| <b>4164703R52</b> .....   | <b>50-52</b> |
| Curtain-rear For Standard Vinyl Top For Use W/ Full View Clear Vinyl. -0.15 ..... <b>\$81.75 EA</b> ⚠   |              |
| <b>4164704R52</b> .....   | <b>51-52</b> |
| Curtain-rear For Superior Vinyl Top For Use W/ Glass Window. -0.15 <b>\$123.25 EA</b> ⚠   |              |
| <b>4164705R52</b> .....   | <b>51-52</b> |
| Curtain-rear For Superior Vinyl Top For Use W/ Full View Clear Vinyl. -0.15 ..... <b>\$103.25 EA</b> ⚠  |              |
| <b>4164702R54</b> .....   | <b>53-54</b> |
| Curtain, rear for Standard Vinyl Top. For use w/ Glass Window. -0 ..... <b>\$73.50 EA</b> ⚠   |              |
| <b>4164703R54</b> .....   | <b>53-54</b> |
| Curtain, rear for Standard Vinyl Top. For use w/ Full View Clear Vinyl. -0.15 ..... <b>\$81.75 EA</b> ⚠   |              |

### Rear Curtain, cont.

|  |              |
|--|--------------|
| <b>4164705R54</b> .....  | <b>53-54</b> |
| Curtain-rear For Superior Vinyl Top For Use W/ Full View Clear Vinyl. -0.15 ..... <b>\$103.25 EA</b> ⚠ |              |
| <b>Top Pads</b>  |              |
| <b>4164900</b> .....   | <b>37-54</b> |
| Pads-Long and Short for Stayfast Top -0.15 ..... starting at <b>\$144.00 SET</b> ⚠                     |              |
| <b>416490040</b> .....   | <b>40</b>    |
| Pads-Long and Short for Stayfast Top -0.15 ..... <b>\$159.00 SET</b> ⚠                                 |              |
| <b>416490140</b> .....   | <b>40</b>    |
| Pads-Long and Short for Superior Vinyl Top -0.15 ..... <b>\$99.50 SET</b> ⚠                            |              |
| <b>4164902</b> .....   | <b>41-52</b> |
| Long and Short for standard vinyl top. -0.15 ..... starting at <b>\$49.00 SET</b> ⚠                    |              |
| <b>4164904</b> .....   | <b>41-52</b> |
| Long & short pads for Superior Vinyl top. -0 ..... starting at <b>\$0.00 SET</b> ⚠                     |              |
| <b>416490048</b> .....   | <b>42-48</b> |
| Pads-Long and Short for Stayfast Top -0.15 ..... <b>\$159.00 EA</b> ⚠                                  |              |
| <b>416490448</b> .....   | <b>42-48</b> |
| Pads-Long and Short for Superior Vinyl Top -0.15 ..... <b>\$99.50 SET</b> ⚠                            |              |
| <b>416490049</b> .....   | <b>49</b>    |
| Pads-Long and Short for Stayfast Top -0.15 ..... <b>\$159.00 EA</b> ⚠                                  |              |
| <b>416490449</b> .....   | <b>49</b>    |
| Pads-Long and Short for Superior Vinyl Top -0.15 ..... <b>\$99.50 SET</b> ⚠                            |              |
| <b>416490254</b> .....   | <b>53-54</b> |
| Long and Short for standard vinyl top. -0.15 ..... <b>\$70.00 SET</b> ⚠                                |              |

### Convertible Top Back Glass

|  |              |
|--|--------------|
| <b>2633</b> .....  | <b>37-38</b> |
| Cabriolet. Clear 11.204 -0.15 <b>\$32.00 EA</b> ⚠  |              |
| <b>2633D</b> .....   | <b>37-38</b> |
| Cabriolet. Tinted Grey 11.204 -0.15 ..... <b>\$36.00 EA</b> ⚠  |              |
| <b>2633T</b> .....   | <b>37-38</b> |
| Cabriolet. Tinted Green 11.204 -0.15 .. <b>\$32.00 EA</b> ⚠  |              |
| <b>2804</b> .....  | <b>40</b>    |
| Cabriolet. Laminated glass. Clear 11.204 -0.15 ..... <b>\$34.00 EA</b> ⚠   |              |
| <b>2804D</b> .....   | <b>40</b>    |
| Cabriolet. Tinted Grey 11.204 -0.15 ..... <b>\$38.00 EA</b> ⚠  |              |
| <b>2804T</b> .....   | <b>40</b>    |
| Cabriolet. Tinted Green 11.204 -0.15 .. <b>\$34.00 EA</b> ⚠  |              |
| <b>2565S</b> .....   | <b>41-50</b> |
| Cabriolet window. Clear. Lexan w/ anti scratch, light makes rear curtain hang better. 11.204 -0.15 ..... <b>\$28.00 EA</b> ⚠ |              |

### Door Weatherstrip And Components

|  |              |
|--|--------------|
| <b>4115115C</b> .....  | <b>40</b>    |
| Cabriolet 10.694 -0 ..... <b>CALL</b> ⚠  |              |
| <b>4115115E</b> .....  | <b>40</b>    |
| Cabriolet w/ upper molded corners. 10.694 -0 ..... <b>CALL</b> ⚠   |              |
| <b>4102073C</b> .....  | <b>40-41</b> |
| Molded upper corners for front & rear of Cabriolet door. Perfect to update pre-available kits (4 pcs). 10.694 -0.15 ..... <b>\$54.75 SET</b> ⚠ |              |
| <b>4114995</b> .....   | <b>40-41</b> |
| Molded upper rear corners. Fits Cabriolet. 10.694 -0.15 ..... <b>\$34.25 L&amp;R</b> ⚠   |              |
| <b>4115230B</b> .....  | <b>40-48</b> |
| Windshield post to vent frame-Cabriolet 10.720 -0.15 ..... <b>\$12.00 SET</b> ⚠  |              |
| <b>4114994C</b> .....  | <b>41</b>    |
| Cabriolet w/out molded corners 10.694 -0 ..... <b>CALL</b> ⚠   |              |
| <b>4114994E</b> .....  | <b>41</b>    |
| Cabriolet. Comes w/ molded upper corners. 10.694 -0 ..... <b>CALL</b> ⚠  |              |
| <b>4102073B</b> .....  | <b>42-48</b> |
| Molded upper corners for front & rear of Cabriolet door. Perfect to update pre-available kits (4 pcs). 10.694 -0 ..... <b>CALL</b> ⚠           |              |
| <b>4111655</b> .....   | <b>42-48</b> |
| Door corner, upper rear. Cabriolet 10.694 -0.4 ..... <b>\$46.25 L&amp;R</b> ⚠  |              |
| <b>4589811</b> .....   | <b>49-52</b> |
| Front (on door) to hinge pillar below window line (dogleg), Convertible & Hardtop 10.694 -0.15 ..... <b>\$114.50 L&amp;R</b> ⚠                 |              |
| <b>4589965B</b> .....  | <b>49-52</b> |
| Windshield post to vent frame-Convertible 14.115 -0.15 ..... <b>\$160.50 L&amp;R</b> ⚠   |              |
| <b>4606455B</b> .....  | <b>49-52</b> |
| Front doors, Hardtop & Convertible, w/ 4589811 10.694 -0 ..... <b>\$199.00 L&amp;R</b> ⚠   |              |

Returns require a return authorization number—call first. • Product pricing & availability subject to change.



**WARNING:** Cancer and Reproductive Harm — www.P65Warnings.ca.gov

# Section 510C: Special Cabriolet-Convertible Parts

## Door Weatherstrip And Components, cont.



**4606231.....51-52**  
Lock pillar, Hardtop & Convertible 10.694 -0.15  
..... **\$47.75 PR** ⚠️  
**4632297BE ....53-54**  
Hardtop & Convertible,  
does 2 doors.  
10.694 -0.15 .....  
**\$266.00 L&R** ⚠️

## Convertible Hydraulic Lines

**4162333B48.....46-48**  
8 piece set. Steel 14.472 -0.15 .....  
**\$385.75 SET** ⚠️  
**416233BS48.....46-48**  
8 piece set. Stainless 14.472 -0.15  
**\$396.75 SET** ⚠️

## Top Cylinder Shaft



**4111346A.....40-41**  
Chrome-vacuum top cylinder 14.475 -0  
..... **CALL** ⚠️

## Top Cylinder Seals



**4112689A ....40-41**  
for both ends of 1  
cylinder. 14.475 -0  
..... **CALL** ⚠️

## Vacuum Top Cylinder



**4111346.....40**  
Vacuum convertible top cylinder pump.  
Fits Cabriolet/convertible 14.475 -0  
..... **CALL** ⚠️

## Hydraulic Top Cylinder



**4149728.....46-50**  
Hydraulic lift cylinder for the convertible  
top. 14.475 -0.15 ..... **\$160.25 EA** ⚠️



**4600036.....51-52**  
Hydraulic lift cylinder for the convertible  
top. 14.475 -0.15 ..... **\$160.00 EA** ⚠️

## Hydraulic Top Cylinder, cont.



**4615148.....53-54**  
Hydraulic lift cylinder for the convertible  
top. 14.475 -0.15 ..... **\$160.25 EA** ⚠️

## Top Cylinder Grommet



**4149726.....46-61**  
Spacer for top cylinder  
mount (4 pcs)  
14.482 -0.15 .....  
**\$28.50 SET** ⚠️

## Top Motor And Pump

**4149729.....46-54**  
Under rear seat type. 12v. 14.481 -0.15  
..... **\$372.75 EA** ⚠️

## Top Pump Rebuild Kits



**4162272R.....46-49**  
For Dura pumps, no gears. -0.15 .....  
**\$114.00 EA** ⚠️



**4162272RG.....46-49**  
For Dura pumps, with gears. -0.15 .....  
**\$240.25 EA** ⚠️

## Gasket



**4149729G.....46-50**  
Top of convertible motor  
reservoir 14.475 -0.4  
..... **\$12.00 EA** ⚠️

## Hydraulic Top Fluid



**603489T.....ALL**  
1 quart 6.386 -0.15  
..... **\$12.00 QT** ⚠️

## Top Motor Mounts

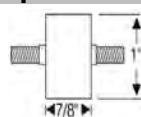

**4149788.....46-50**  
For hydraulic top motor  
(3 pcs) 14.486 -0.15  
..... **\$30.25 EA** ⚠️

## Top Motor Hoses, cont.

**4162333.....46-48**  
1/2in. o.d. x 8in. (uses 2) 14.472 -0.15  
..... **\$62.00 EA** ⚠️

**4149729A.....46-54**  
For under rear seat style pump 14.481 -0.15  
..... **\$185.00 PR** ⚠️

**4558822.....49-50**  
8 3/4in. long 14.472 -0.15  
..... **\$42.25 EA** ⚠️

**4565379.....49-50**  
6 1/4in. long 14.472 -0.15  
..... **\$66.75 EA** ⚠️

## Top Switch



**4166069.....40-41**  
Correctly functioning  
vacuum top switch  
14.465 -0.2 .....  
**\$75.00 EA** ⚠️



**001463.....46-50**  
Mounts on firewall.  
Controlled by the  
push-pull top switch  
rod. 6v or 12volt.  
14.483 -0 ..... **CALL** ⚠️

## Firewall Grommets



**4111335A.....40-41**  
Cabriolet top vacuum  
hose. 14.472 -0.15  
..... **\$5.50 EA** ⚠️



**609864.....46-48**  
Hydraulic top tubes.  
14.472 -0.15 .....  
**\$2.25 EA** ⚠️



**4565380.....49-50**  
Hydraulic top tubes.  
14.472 -0.15 .....  
**\$31.00 EA** ⚠️

## Window Flipper



**4116622.....41**  
Chrome (follows glass down) fits cabriolet  
only 10.699 -0.15 ..... **\$299.00 EA** ⚠️

## Window Flipper Spring



**4112621B.....41**  
2 per door, Cabriolet 10.699 -0.15 .....  
**\$26.00 L&R** ⚠️

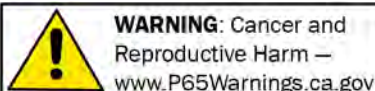

**WARNING: Cancer and Reproductive Harm** —  
www.P65Warnings.ca.gov

Chemicals shipped domestic ground only (Lower 48 states only). No international shipping.

Phone: (360) 816-0211 • (800) 999-CHEV (2438) • www.chevsofthe40s.com



**Mirror King Bee**



**515848A** .....37-54  
Left side. 4-1/2in. (40-47 were originally 4in. ). Fits 49-54 Sedan Delivery, 48-50 Convertible & Hardtop. Mounting holes= 2" on center. 10.185 -0.15 ..... **\$82.75 EA** ⚠



**986305A** .....37-54  
Right side. 4-1/2in. (40-47 were originally 4in. ). Fits 49-54 Sedan Delivery, 48-50 Convertible & Hardtop. 10.185 -0.15 ..... **\$86.25 EA** ⚠

**Sunvisor**



**4090488A** .....37-48  
Bracket for interior visor (windshield frame 1/2). Fits Cabriolet. Requires 2 per visor. 10.219 -0.15 ..... **\$76.00 EA** ⚠



**4090488** .....40-50  
Interior visor bracket (visor 1/2 only) Fits Cabriolet & Hardtop. Requires 2 per visor. 10.219 -0.15 ..... **\$60.00 EA** ⚠

**Header Bow Weatherstrip**



**4074277** .....37-38  
Front bow to windshield inner 10.033 -0.15 ..... **\$131.00 PR** ⚠



**4079765** .....37-38  
Front bow to windshield, outer right & left, w/ hook end & holes 10.033 -0.15 ..... **\$120.50 PR** ⚠

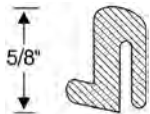

**4114973** .....40-48  
On windshield frame to front bow 14.060 -0.4 ..... **\$26.50 EA** ⚠

**Header Bow Weatherstrip, cont.**



**4114981** .....40-48  
On front bow to windshield 14.060 -0.4 ..... **\$26.25 EA** ⚠

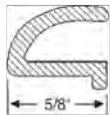

**4563765** .....49-52  
On front bow to windshield 14.060 -0.15 ..... **\$70.75 EA** ⚠

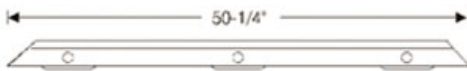

**4566232** .....49-52  
On windshield frame to front bow 14.060 -0.15 ..... **\$240.50 EA** ⚠



**4191680** .....53-54  
On front bow to windshield 14.060 -0.15 ..... **\$70.75 EA** ⚠

**Roof Rail Weatherstrip**



**4115232B** .....35-41  
7 ft strip 10.720 -0.15 ..... **\$38.75 SET** ⚠



**4132245C** .....42-48  
Molded roof rail & windshield post, as original. 8 piece set. 10.721 -0.15 ..... **\$402.00 SET** ⚠

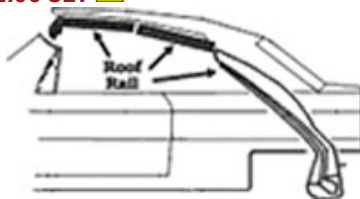

**4583685B** .....49-52  
Molded roof rail (6 pcs). 10.721 -0.15 ..... **\$374.00 SET** ⚠



**4583685C** .....49-52  
Molded roof rail- (6 pcs) Superior!!! 10.721 -0.2 ..... **\$309.00 SET** ⚠

**Roof Rail Weatherstrip, cont.**

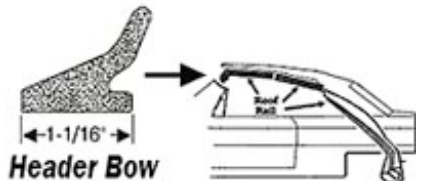

**4615003B** .....53-54  
Molded roof rail & header bow (9 pcs). 14.120 -0.15 ..... **\$487.50 SET** ⚠

**Windshield Post Weatherstrip**

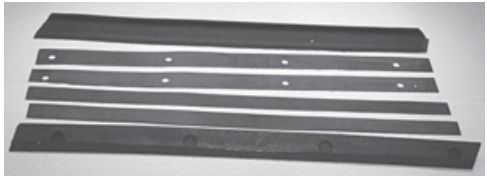

**4115230** .....40-48  
Windshield post to vent frame w/ original cloth cover Cabriolet (also see 4115230B) 10.720 -0.15 ..... **\$56.00 SET** ⚠

**Weatherstrip Header Bow Clip**



**4081541** .....37-38  
Front bow weatherstrip to header bow (uses approximately 30) 10.034 -0.15 ..... **\$4.25 EA** ⚠

**Tacking Strip**



**4112065A** .....ALL  
Convertible top (1/2 x 5/16) 13.384 -0.3 ..... **\$3.25 FT** ⚠



**4112065C** .....ALL  
Convertible top (5/8 x 1/8) 13.384 -0.4 ..... **\$3.25 FT** ⚠

**Side Rail Rubber Filler**



**4115405** .....41-48  
Side rail to header bow 14.222 -0.15 ..... **\$19.00 PR** ⚠



**4564058** .....49-52  
Side rail to header bow 14.070 -0.15 ..... **\$76.00 PR** ⚠

**Side Rail Cushion**



**4116637** .....41-48  
Side rail hinge, cement to your steel core 14.226 -0.15 ..... **\$30.00 PR** ⚠

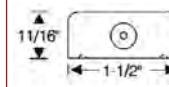

**4615046** .....53-57  
Steel core w/ hole, side rail hinge (4 pcs) 14.110 -0.15 ..... **\$64.25 PR** ⚠

# Section 510C: Special Cabriolet-Convertible Parts

## Side Rail Bumper



**4116637.....41-52**  
Folding post rest on female hinge, cement to your steel core  
14.226 -0.15 .....

**\$30.00 PR** ⚠️

## Rubber Caps



**4604967.....41-52**  
Grey, covers ends of top linkage, cars use 4  
14.200 -0.15 .....

**\$41.00 PR** ⚠️

## Spring Washer



**3710896.....ALL**  
3/8in. i.d. Convertible top pivots (4 pcs)  
8.982 -0.4 .....

**\$2.25 SET** ⚠️

## Side Rail Pads

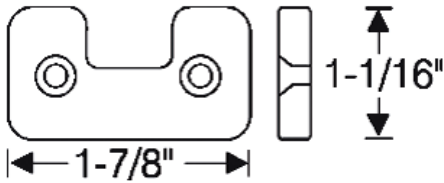

**4075487.....37-38**  
Base of folding post behind door glass (steel cores) 14.122 -0.15 .....

**\$114.50 PR** ⚠️

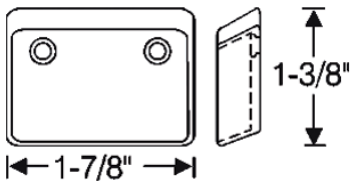

**4101880.....40**  
Base of folding post behind door glass (steel cores) 14.122 -0.15 .....

**\$110.00 PR** ⚠️

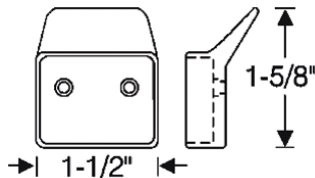

**4112683.....41**  
Base of folding post behind door glass (steel cores) 14.122 -0.15 .....

**\$75.00 PR** ⚠️

## Side Rail Pads, cont.



**4134969.....42-48**  
Base of folding post behind door glass (steel cores) 14.122 -0.15 .....

**\$113.00 PR** ⚠️

## Rear Bow Bumper

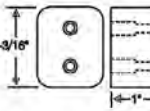

**4565772.....49-52**  
For rear bow (steel core)  
14.270 -0.15 .....

**\$98.75 PR** ⚠️

## Top Rest Rubber Pads



**4125797.....41**  
For top rests in top well  
11.381 -0.15 .....

**\$27.75 PR** ⚠️



**3681070.....42-48**  
For top rests in top well  
16.400 -0.15 .....

**\$9.00 SET** ⚠️

## Door Glass Frame

**4560812.....49-52**  
Chrome, right, fits Hardtop & Convertible  
10.689 -0.15 .....

**\$148.75 EA** ⚠️

**4560813.....49-52**  
Chrome, left, fits Hardtop & Convertible  
10.689 -0.15 .....

**\$148.75 EA** ⚠️

**4601066.....53-54**  
Chrome, right, fits Hardtop & Convertible  
10.689 -0.15 .....

**\$122.25 EA** ⚠️

**4601067.....53-54**  
Chrome, left, fits Hardtop & Convertible  
10.689 -0.15 .....

**\$122.25 EA** ⚠️

## Quarter Glass Frame Top Half

**4628626.....53-54**  
Chrome for upper right on Convertible  
11.024 -0.15 .....

**\$115.25 EA** ⚠️



**4628627.....53-54**  
Chrome for upper left on Convertible  
11.024 -0.15 .....

**\$115.25 EA** ⚠️

## Bowdrill



**4132245T.....ALL**  
Cloth (black) 3 ft x 1 ft for roof rail weather strip, quarter window vertical seal & back of windshield post weatherstrip. 10.721 -0.15 .....

**\$6.00 SET** ⚠️

## Channel Kits And Components

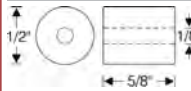

**4091152.....31-55**  
Door glass rubber roller. Fits hardtop & Convertible (4 pcs)  
10.726 -0.3 .....

**\$9.00 SET** ⚠️

**4045914D.....37-41**  
Front Door Window Channel Kit. Cabriolet -0.3 .....

**starting at \$62.75 EA** ⚠️



**4114117.....40-54**  
Window stop bumper (upper). Fits hardtop & Convertible 10.716 -0.2 .....

**\$7.00 SET** ⚠️



**4115231.....40-55**  
Rubber sweeper (in slot outside of door glass channel). Fits  
Convertible & Hardtop (3ft) 10.720 -0.15 .....

**\$19.25 EA** ⚠️



**4609684.....41-54**  
Window stop bumper (lower). Fits hardtop & Convertible 10.716 -0.15 .....

**\$7.50 PR** ⚠️

**4045914E.....42-52**  
Front Door Window Channel Kit. 1942-52 Cabriolet & Hardtop -0.4 .....

**starting at \$67.25 PR** ⚠️

**4045914J52.....42-52**  
Quarter Window Channel Kit Cabriolet/convertible 10.701 -0.15 .....

**\$80.00 PR** ⚠️

**4045914G52.....49-52**  
Front Door Window Channel Kit Convertible 10.701 -0.15 .....

**\$120.00 PR** ⚠️

**4162170.....49-52**  
Anti-rattle bumpers on garnish moulding. Fits hardtop & Convertible (4 pcs) 11.139 -0.15 .....

**\$10.75 SET** ⚠️

**4180904.....49-58**  
Window stop bumper. Top of vent divider bar. Fits hardtop & Convertible 10.702 -0.15 .....

**\$49.25 PR** ⚠️

**4045914P54.....53-54**  
Quarter Window Channel Kit Convertible 10.701 -0.15 .....

**\$125.00 PR** ⚠️

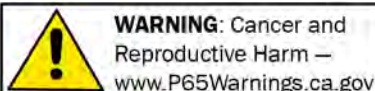

Chemicals shipped domestic ground only (Lower 48 states only). No international shipping.

Phone: (360) 816-0211 • (800) 999-CHEV (2438) • www.chevsofthe40s.com



# Section 510C: Special Cabriolet-Convertible Parts

## Channel Kits And Components, cont.

**4045914U54** ..... **53-54**  
 Front Door Window Channel Kit  
 Convertible 10.701-0.15 .....  
**\$93.25 PR** ⚠

## Glass Setting Kit



**603953F57** ..... **37-57**  
 Fits Convertible & Hardtop Chrome window frames. (144 in. length) 10.696-0.15

**\$13.75 SET** ⚠



**603953Q53** ..... **42-54**  
 Fits Convertible & Hardtop (120 in. length) 10.696-0.15

**\$11.75 SET** ⚠



**603954C** ..... **ALL**  
 Vent glass. Does both sides. (120 in. length) 10.696-0.15

**\$16.25 SET** ⚠

## Seal Front Of Quarter Glass



**4131898** ..... **42-62**  
 Seal & Bowdrill Cloth Front of quarter glass. Fits Hardtop & Convertible. 11.015-0.15 ..... **\$42.75 PR** ⚠

## Door Bumper

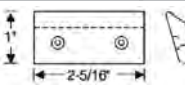

**4074396** ..... **37-38**  
 Rubber w/ steel core, 2 screw holes. Seal at door hinge post at dash.

Fits Cabriolet 10.720-0.15 ..... **\$92.75 PR** ⚠

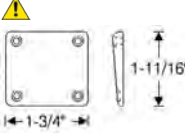

**4076899** ..... **37-52**  
 Rubber Wedge. Rear of Convertible & Hardtop door 10.587-0.15

**\$20.00 PR** ⚠

## Door Weatherstrip Complete



**4115526C** ..... **42-48**  
 Complete w/ upper molded corners. Fits Cabriolet (for 2 doors). 10.694-0

**CALL** ⚠

## Door Plug



**4049538A** ..... **40-48**  
 Cabriolet door tension adjust hole-bottom rear 10.380-0.15

**\$1.50 PR** ⚠

## Bezel Power Top



**4111327** ..... **40-41**  
 Behind top knob 14.468-0 .. **CALL** ⚠

## Knob



**4111332** ..... **40**  
 Cabriolet top (ivory). 14.467-0 .. **CALL** ⚠



**4116581** ..... **41**  
 Cabriolet top (copper swirl center). 14.467-0.4 .. **\$14.00 EA** ⚠

## Latch Handle



**4134975** ..... **37-48**  
 Superior quality, Left, Right & Center. Chromed Brass handles & latch plates 14.080-0.15 ..... **\$1,247.00 SET** ⚠



**4134975A** ..... **37-48**  
 Unfinished handles. Left, Right & Center. 14.080-0.15 ..... **\$575.00 SET** ⚠

## Striker Set



**4116636B** ..... **37-48**  
 Unfinished strikers. Left, Right & Center. With hardware. 14.080-0.15

**\$255.75 SET** ⚠

**4602565** ..... **53-54**  
 Convertible stainless striker set of 3. Made in USA -0 .. **\$225.00 SET** ⚠

## Stud



**4603455** ..... **49-54**  
 Convertible Stud Set 3 Pieces stainless 14.090-0 ..... **\$125.50 SET** ⚠

## Top Handle Screw

**4561892** ..... **49-54**  
 Top Handle Screw -0 ..... **\$45.00 EA** ⚠

## Latch Base Plate



**4563861** ..... **49-54**  
 Convertible header bow latch base plate 14.080-0 ..... **CALL** ⚠

## Wood Top Bow

**4111321** ..... **40**  
 Grooved for dome light 14.183-0 .. **\$548.00 EA** ⚠

**4134953** ..... **42-48**  
 Grooved for dome light 14.183-0.15 **\$663.00 EA** ⚠

**4565300** ..... **49-52**  
 Grooved for dome light 14.183-0.15 **\$709.75 EA** ⚠

## Wood Side Rail Pieces

**4116639A** ..... **41**  
 Fits convertible only. 14.115-0.15 .. **\$445.00 L&R** ⚠

**4115233** ..... **42-48**  
 Convertible top wood side rail pieces. 14.115-0.15 ..... **\$400.00 L&R** ⚠

## Rear Seat Spring

**4111790** ..... **40**  
 Lower-Cabriolet 15.033-0.15 ..... **\$500.50 EA** ⚠

**4111798** ..... **40**  
 Upper-Cabriolet 14.998-0.15 ..... **\$462.00 EA** ⚠

**4118444** ..... **41**  
 Upper-Cabriolet 14.998-0.15 ..... **\$462.00 EA** ⚠

**4123393** ..... **41**  
 Lower-Cabriolet 15.033-0.15 ..... **\$500.50 EA** ⚠

**4139723** ..... **42-48**  
 Upper-Cabriolet 14.998-0.15 ..... **\$462.00 EA** ⚠

**4140898** ..... **42-48**  
 Lower-Cabriolet 14.998-0.15 ..... **\$539.00 EA** ⚠

Returns require a return authorization number—call first. • Product pricing & availability subject to change.



**WARNING:** Cancer and Reproductive Harm — www.P65Warnings.ca.gov

**Rear Seat Spring, cont.**

**4171032** ..... **49-52**

Lower-Convertible 14.998 -0.15 .....

**\$577.50 EA** ⚠

**4171044** ..... **49-52**

Upper-Convertible 14.998 -0.15 .....

**\$539.00 EA** ⚠

**Odds And Ends**

Please call for availability on all Odds & Ends parts. Once part is sold, it may no longer be in stock.

**4111346U** ..... **40**

Vacuum top cylinder (Used). 14.475 -0.4 .

**\$125.00 EA** ⚠

**4132246BR** ..... **42-48**

Hinge assembly complete, cabriolet top fits left side 14.130 -0.4 .. **\$200.00 EA** ⚠

**4630378** ..... **53-54**

Convertible top bow with dome light. Good condition (Used). 14.340 -0.4 .....

**\$175.00 EA** ⚠

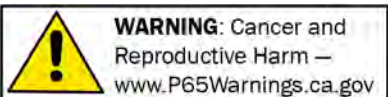

Chemicals shipped domestic ground only (Lower 48 states only). No international shipping.

**Phone: (360) 816-0211 • (800) 999-CHEV (2438) • [www.chevsofthe40s.com](http://www.chevsofthe40s.com)**



**SECTION 520C  
RESTORATION PARTS**

**Engineering Feature Manual**



**ENG37M ..... 37**  
Engineering Feature Manual, Car & Truck  
18.300 -0.15 .....  
**\$24.00 EA** ⚠️



**ENG39M ..... 39**  
Engineering Feature Manual, Car & Truck  
18.300 -0.15 .....  
**\$24.00 EA** ⚠️



**ENG47M ..... 47**  
Engineering feature manual, Car & Truck  
18.300 -0.15 .....  
**\$24.00 EA** ⚠️



**ENG48M ..... 48**  
Engineering Feature Manual, Car & Truck  
18.300 -0.15 ..... **CALL** ⚠️



**ENG52M ..... 52**  
Car & Truck 18.300 -0.15 .....  
**\$24.00 EA** ⚠️

**Owners Manual**



**OWNC ..... 37-54**  
Specify year when ordering 18.000 -0.15  
starting at **\$12.00 EA** ⚠️

**Sales Brochure**



**SALE. .... 37-54**  
Super color reproduction of original brochure (specify year when ordering) 18.800 -0  
starting at **\$9.00 EA** ⚠️

**Folder**



**OWNFD ..... ALL**  
For owners' manual & papers, Chevrolet Motor Division, original type  
18.000 -0.15 .....  
**\$6.00 EA** ⚠️

**Convertible Top Manual**



**ACC37I ..... 37-38**  
Folding instructions, original 37 18.000 -0.15 .....  
**\$2.00 EA** ⚠️

**Cabriolet Top Folding Instructions**

**ACC41I ..... 41**  
Instruction sheet for the convertible folding top on a Cabriolet. 18.000 -0.15 .....  
**\$2.00 EA** ⚠️

**Convertible Top Folding Booklets, cont.**



**CONV46. .... 46-48**  
Manual (every convertible had one)  
18.000 -0.15 .....  
**\$10.00 EA** ⚠️



**CONV49. .... 49-52**  
Every convertible had one copy 18.000 -0.15 .....  
**\$10.00 EA** ⚠️



**CONV53. .... 53**  
Every convertible had one 18.000 -0 .. **CALL** ⚠️



**CONV54. .... 54**  
Every convertible had one 18.000 -0.15 .....  
**\$11.50 EA** ⚠️

**AC Parts Catalog**



**PARTAC41. .... 29-41**  
Oil, fuel & air filters, speedometer cables  
18.200 -0.4 .....  
**\$4.00 EA** ⚠️

**Parts Book on CD**

**PART61CD ..... 29-61**  
29-61 Cars, Trucks & 53-61 Corvette.  
18.200 -0.15 ..... **\$30.75 EA** ⚠️  
**DCDGM-145 ..... 29-72**  
29-72 parts book. 18.300 -0.3 .....  
**\$35.00 EA** ⚠️



**PART72CD ..... 38-72**  
38-64 Cars, 38-72 Trucks & 53-64 Corvette. 18.200 -0.15 .....  
**\$30.75 EA** ⚠️

**Parts Book**



**PART39 ..... 29-42**  
For 42 & Earlier  
18.200 -0.15 .....  
**\$50.00 EA** ⚠️



**PART50 ..... 29-50**  
For 50 & Earlier  
18.200 -0.15 .....  
**\$68.25 EA** ⚠️



**PART54 ..... 29-54**  
Chevrolet Master Parts and Accessories catalog, reprint.  
18.200 -0.15 .....  
**\$75.25 EA** ⚠️



**PART57 ..... 29-57**  
Chevrolet Body Parts and Accessories Catalog 18.200 -0.15 .....  
**\$75.25 SET** ⚠️



**PART42W ..... 35-41**  
Woody wagon & Suburban 18.200 -0.3 .....  
**\$10.00 EA** ⚠️

**Parts Book, cont.**



**PART48W ..... 46-48**  
Woody Wagon  
18.200 -0.15 .....  
**\$27.50 EA** ⚠️

**Parts Interchange**



**PART51N. .... 29-52**  
Chev, Pontiac, Oldsmobile 18.200 -0.15 .....  
**\$24.00 EA** ⚠️

**Books**



**BOOK12V ..... ALL**  
6v to 12v conversion  
19.500 -0.15 .....  
**\$14.00 EA** ⚠️



**GASBOOK01 ..... ALL**  
Title of this book "The Official Guide to Modern Gasoline & Oil for Antique Vehicles" says  
it all. 19.500 -0.15 .....  
**\$15.00 EA** ⚠️

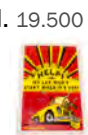

**HOTSTARTBOOK. . . ALL**  
Each of us has owned, or knows of someone who has owned an antique vehicle, muscle

car, or hot rod that refuses to start when the engine is warm. To make this more aggravating, the vehicle seems to start fine when the engine is cold. In this book Randy will help you to identify and fix your hot start problem once and for all. 68 pages with color illustrations throughout. -0.15 ..... **\$17.25 EA** ⚠️

**Mechanics Repair Manual**



**SHOP37M ..... 37-38**  
A must for Do-It-Yourselfers. 18.300 -0 .....  
**CALL** ⚠️

**Shop Manuals on CD**

All CDs contain the factory service or shop manual and any applicable supplement. The factory manual is essential. It includes coverage on all mechanical and electrical systems. This is where you find specifications, wiring diagrams, diagnostic procedures, troubleshooting, installation and removal, and covers all systems. CDs contain the body service manual as well. In some cases, the body information is included in the service manual. Parts books are included on most CDs; check content information for specifics.



**DCDGM-51 ..... 37**  
Includes 1937 shop manual, 29-48 parts book for 1937 cars & trucks. 18.300 -0.3 .....  
**\$35.00 EA** ⚠️



**Shop Manuals on CD, cont.**



**SHOP37CD ..... 37-38**  
Car & truck on CD  
18.300 -0.15 .....  
**\$30.75 EA** ⚠️

**DCDGM-52..... 38-38**  
Includes 1938 shop manual, 29-48 parts book & 38-68 parts book for 1938 cars & trucks. 18.300 -0.3 ..... **\$35.00 EA** ⚠️



**DCDGM-53 ..... 39**  
Includes 1939 shop manual, 39-40 Fisher body manual, 29-48 parts book & 38-68

parts book for 1939 cars & trucks. 18.300 -0.3 ..... **\$35.00 EA** ⚠️



**SHOP39CD ..... 39-40**  
Car & truck manuals on CD. 18.300 -0.15 .....  
**\$30.75 EA** ⚠️

**DCDGM-55..... 41**  
Includes 1941 shop manual, 29-48 parts book & 38-68 parts book for 1941 cars & trucks. 18.300 -0.3 ..... **\$70.00 EA** ⚠️



**SHOP41CD ..... 41-48**  
41-48 Car & 41-46 Truck on CD. 18.300 -0.15 .....  
**\$30.75 EA** ⚠️

**DCDGM-56..... 42-48**  
Includes 1942-48 shop manual, 29-48 parts book & 38-68 parts book for 1942-48 cars & 42-48 trucks. 18.300 -0.2 ..... **\$55.00 EA** ⚠️

**DCDGM-57..... 49-54**  
Includes 1949-54 shop manual, 53-63 mouldings book, 53-62 Corvette service, 49-58 parts book & 38-68 parts book for 1949-54 cars. 18.300 -0.3 ..... **\$70.00 EA** ⚠️



**SHOP49CD ..... 49-54**  
49-54 Cars. 18.300 -0.15 .....  
**\$30.75 EA** ⚠️

**Shop Manual**



**SHOP37..... 37**  
Car & truck, full size. Superb! 18.300 -0.15 .....  
**\$24.00 EA** ⚠️



**SHOP38..... 38**  
W/ car & truck, full size. Superb! 18.300 -0.15 .....  
**\$24.00 EA** ⚠️

**SHOP38P ..... 38**  
W/ car & truck, 3/4 size photocopy 18.300 -0 ..... **CALL** ⚠️



**SHOP39..... 39**  
W/ car & truck, full size. Superb! 18.300 -0.15 .....  
**\$24.00 EA** ⚠️

**Shop Manual, cont.**



**SHOP40..... 40**  
W/ car & truck, full size. Superb! 18.300 -0.15 .....  
**\$24.00 EA** ⚠️



**SHOP41..... 41**  
W/ car & truck, full size. Superb! 18.300 -0.15 .....  
**\$24.00 EA** ⚠️



**SHOP42..... 42-48**  
Car & 42-46 truck, full size. Superb! 18.300 -0.15 .....  
**\$26.00 EA** ⚠️

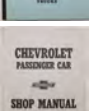

**SHOP49..... 49-54**  
Car, full size. Superb! 18.300 -0.15 .....  
**\$24.00 EA** ⚠️



**SHOP50PG ..... 50-54**  
Includes 54 Supplement Data 18.300 -0.15 .....  
**\$29.00 EA** ⚠️

**Good Housekeeping**



**HOUS1..... ALL**  
In your car by GM, Fisher body, removing 17 upholstery stains, 29 pages 18.230 -0.3

**\$6.25 EA** ⚠️

**Fisher Body Manual**



**BODY37..... 37-38**  
Superb reproduction 18.400 -0.15 .....  
**\$18.00 EA** ⚠️



**BODY39..... 39-40**  
Superb reproduction 18.400 -0.15 .....  
**\$18.00 EA** ⚠️



**BODY49W ..... 49**  
Woody Wagon 18.400 -0 ..... **CALL** ⚠️



**BODY49P ..... 49-52**  
Copy, original 49 (exc Wagon) 18.400 -0.15 .....  
**\$16.00 EA** ⚠️

**Fisher Body Construction**



**BODY41B ..... 41**  
& Adjustment Of Doors, Seats, Convertible Top 18.400 -0.15 .....  
**\$18.00 EA** ⚠️



**BODY46..... 42-48**  
& adjustment of doors, seats, convertible top 18.400 -0.15 .....  
**\$18.00 EA** ⚠️

**Service Bulletins**

Note: 1 bulletin was issued every month (except during WWII) to Chevrolet dealers on fixing new car problems. Introduction issue is previous year of vehicle, so you need three years (prior, actual and following year) for complete bulletin coverage. Invaluable information on your vehicle.



**SERV ..... 37-54**  
12 month, specify year when ordering 18.500 -0.15 .....starting at **\$20.00 EA** ⚠️

**Glove Box Accessory Book**



**ACC37B..... 37**  
Color repro of original w/ pictures of all those rare accessories. 18.600 -0.15 .....  
**\$14.00 EA** ⚠️



**ACC38B..... 38**  
Repro of original w/ pictures of all those rare accessories. Sepia, 9in. x 11in. 18.600 -0.15 .....  
**\$14.00 EA** ⚠️



**ACC39B..... 39**  
Color repro of original w/ pictures of all those rare accessories. 18.600 -0.15 .....  
**\$14.00 EA** ⚠️



**ACC40B..... 40**  
Color repro of original w/ pictures of all those rare accessories. 18.600 -0.15 .....  
**\$14.00 EA** ⚠️



**ACC41B..... 41**  
Color repro of original w/ pictures of all those rare accessories. 18.600 -0.15 .....  
**\$14.00 EA** ⚠️



**ACC48B..... 46-48**  
Color repro of original w/ pictures of all those rare accessories. Original 48. 18.600 -0.15 .....  
**\$14.00 EA** ⚠️



**ACC49B..... 49**  
Color repro of original w/ pictures of all those rare accessories. 18.600 -0.15 .....  
**\$14.00 EA** ⚠️

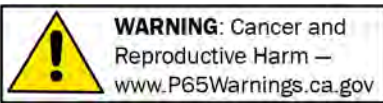

Chemicals shipped domestic ground only (Lower 48 states only). No international shipping.

**Phone: (360) 816-0211 • (800) 999-CHEV (2438) • www.chevsofthe40s.com**



**Glove Box Accessory Book, cont.**



**ACC50B..... 50**  
Color repro of original w/ pictures of all those rare accessories.  
18.600 -0.15 .....

**\$14.00 EA** ⚠



**ACC51B..... 51**  
This is a reproduction of the "Chevrolet Accessories" booklet that came in the glove box. It has pages of pictures with all those rare accessories to be on the lookout for.

Over 30 pages -Titled "The Sparkling New Line" booklet for your Genuine Chevrolet Accessories. 18.600 -0.15 **\$14.00 EA** ⚠



**ACC52B..... 52**  
Color repro of original w/ pictures of all those rare accessories.  
18.600 -0.15 .....

**\$14.00 EA** ⚠



**ACC52F..... 52**  
Color repro of original w/ pictures of all those rare accessories.  
18.600 -0.2 .....

**\$19.25 EA** ⚠



**ACC53B..... 53**  
Color repro of original w/ pictures of all those rare accessories.  
18.600 -0.15 .....

**\$14.00 EA** ⚠



**ACC54B..... 54**  
Color repro of original w/ pictures of all those rare accessories.  
18.600 -0.15 .....

**\$14.00 EA** ⚠

**Accessory Identifying Book**



**ACC01B..... 46-78**  
All accessories 1946-78 in numerical order, superb for identifying.  
18.600 -0.15 .....

**\$25.00 EA** ⚠

**Accessory List**

**ACC\_L..... 37-54**  
With part numbers & prices (great for swap meets) (specify year after "ACC").  
18.700 -0.4 ..... starting at **\$5.00 EA** ⚠

**RPO Booklet**



**RP047..... 47**  
W/ regular production options 18.800 -0.15  
**\$5.00 EA** ⚠



**RP049..... 49**  
W/ regular production options 18.800 -0.15  
**\$5.00 EA** ⚠



**RP054..... 54**  
W/ regular production options 18.800 -0.2 ..  
**\$6.50 EA** ⚠

**Price Guide**



**PRICE37..... 37**  
Advertised delivered prices of vehicles & accessories 18.700 -0.15  
..... **\$3.25 EA** ⚠



**PRICE38..... 38**  
Advertised delivered prices of vehicles & accessories 18.700 -0  
..... **CALL** ⚠



**PRICE39..... 39**  
Advertised delivered prices of vehicles & accessories 18.700 -0.15  
..... **\$3.25 EA** ⚠

**Casting Numbers**



**CAST42..... 29-42**  
Identification book  
18.600 -0.15 .....

**\$10.00 EA** ⚠

**SECTION 530C RESTORATION PARTS**

Copies of originals wanted: Original accessory instruction sheets 1937-54 or sharp copies.

**Radio Manual**

**ACC431..... 36-47**  
18.900 -0 ..... **\$1.00 EA** ⚠



**985253M..... 37**  
6 tube header speaker w/ installation instructions 18.900 -0.4 .... **\$4.00 EA** ⚠



**985254M..... 37**  
6 tube w/ installation instructions 18.900 -0.4 ..... **\$3.00 EA** ⚠

**985255M..... 37**  
7 tube speaker on firewall w/ installation instruction 18.900 -0 ..... **CALL** ⚠

**985285M..... 38**  
6 tube header speaker w/ install 18.900 -0.2 ..... **\$3.00 EA** ⚠

**985424M..... 39**  
7 tube twin speaker w/ install 18.900 -0.4 ..... **\$3.00 EA** ⚠

**985426M..... 39**  
6 tube single unit 18.900 -0.4 .. **\$3.00 EA** ⚠

**985538M..... 40**  
5 tube, 4 button (original 40). 18.900 -0.4 ..... **\$3.00 EA** ⚠

**985536M..... 40-41**  
8 tube w/ installation 18.900 -0.2 ..... **\$3.00 EA** ⚠

**985694M..... 41**  
8 tube w/ wonder bar w/ installation instruction 18.900 -0.2 ..... **\$3.00 EA** ⚠

**985695M..... 41**  
6 tube 6 button w/ installation instructions. 18.900 -0.4 .... **\$3.00 EA** ⚠

**985697M..... 41**  
5 band w/ shortwave manual and packing list 18.900 -0 ..... **CALL** ⚠

**ACC831..... 41-48**  
Push button (original 47) installation & instructions 18.900 -0.15 ... **\$6.00 EA** ⚠

**985793M42..... 42**  
6 tube single unit 18.900 -0.2 .. **\$3.00 EA** ⚠

**985794M..... 42**  
9 tube 5 band w/ shortwave manual and packing list 18.900 -0.4 ..... **\$7.00 EA** ⚠



**Radio Manual, cont.**

- 985793M** ..... **42-48**  
6 tube 5 button (original 47) installation  
& instructions 18.900 -0.3 .. **\$3.00 EA** ⚠
- 985793M46** ..... **46**  
6 tube single unit 18.900 -0.2 .. **\$3.00 EA**  
⚠
- 986388M** ..... **49-50**  
6 tube push button (original 50)  
installation & instructions 18.900 -0.2 ...  
**\$13.50 EA** ⚠

**Accessory Installation Manual**

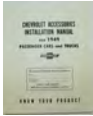

- ACC49M** ..... **49**  
Superb 18.900 -0.15 ..  
**\$14.00 EA** ⚠

- ACC49E** ..... **49-54**  
Per accessory 18.900 -0 ..... **CALL** ⚠
- ACC50M** ..... **50**  
Superb 18.900 -0.15 ..... **\$12.00 EA** ⚠
- ACC51M** ..... **51**  
Superb 18.900 -0.15 ..... **\$12.00 EA** ⚠
- ACC52M** ..... **52**  
Superb 18.900 -0.15 ..... **\$14.50 EA** ⚠
- ACC53M** ..... **53**  
Superb 18.900 -0.15 ..... **\$12.00 EA** ⚠
- ACC54M** ..... **54**  
Superb 18.900 -0.15 ..... **\$14.00 EA** ⚠

**Antenna Installation Sheets**



- ACC65I** ..... **37-40**  
Under running board  
(original 40) 18.900 -0.15 .....  
**\$2.00 EA** ⚠



- 985531I** ..... **39-46**  
Install instructions  
18.900 -0.4 ..... **\$2.00 EA**  
⚠

- ACC03T** ..... **41**  
Side mount w/ template 19.000 -0.3 ...  
**\$2.00 EA** ⚠



- ACC81I** ..... **41-42**  
Reel 18.900 -0.15 .....  
**\$2.00 EA** ⚠

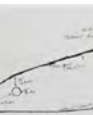

- ACC04T** ..... **42-48**  
Top mount template  
only 19.000 -0.15 .....  
**\$1.00 EA** ⚠

- ACC73I** ..... **42-48**  
Instructions includes template 18.900 -0.15  
..... **\$2.00 EA** ⚠

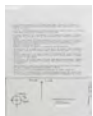

- ACC74I** ..... **49-52**  
Includes template  
18.900 -0.15 .....  
**\$2.00 EA** ⚠



- ACC75I** ..... **53-54**  
Includes template  
18.900 -0.15 .....  
**\$2.00 EA** ⚠

**Arm Rest Installation Sheet**



- ACC04I** ..... **41-42**  
Center fold down  
18.900 -0.3 ..... **\$2.00 EA**  
⚠

**Back Up Light Installation Sheets**



- ACC28I** ..... **39**  
Template w/  
instructions 18.900 -0.3  
..... **\$2.00 EA** ⚠



- ACC01T** ..... **41**  
Our template 18.900 -0.3  
..... **\$1.00 EA** ⚠

- ACC80I** ..... **42-46**  
Template w/ instructions 18.900 -0.4 ..  
**\$2.50 EA** ⚠

- ACC29I** ..... **47-48**  
Template w/ instructions 18.900 -0.3 ..  
**\$2.00 EA** ⚠

- ACC30I** ..... **49**  
Template w/ instructions 18.900 -0.3 ..  
**\$2.00 EA** ⚠

**Cigarette Lighter Installation Sheet**

- ACC45I** ..... **42-53**  
This is a nice reproduction of the original  
cigar / cigarette lighter installation sheet.  
18.900 -0.15 ..... **\$2.00 EA** ⚠

**Clock Installation Sheet**

- ACC64I** ..... **41-48**  
30-hour wind up 18.900 -0.4 ..... **\$1.00 EA**  
⚠

**Compass Installation Sheets**



- ACC25I** ..... **37-42**  
For glove box 18.900 -0.3  
..... **\$2.00 EA** ⚠

- ACC26I** ..... **46-48**  
For glove box 18.900 -0.3 ..... **\$2.00 EA** ⚠

**Defroster Installation Sheet**

- ACC48I** ..... **40-49**  
Used w/ under seat heater 18.900 -0.15  
..... **\$2.00 EA** ⚠

**Emergency Brake Whistle Installation Sheet**



- ACC27I** ..... **39-48**  
18.900 -0.15 .....  
**\$1.00 EA** ⚠

**Fender Skirt Installation Sheet**



- ACC54I** ..... **41**  
18.900 -0.15 .....  
**\$2.00 EA** ⚠

**Fil-Guard Installation Sheet**

- ACC03I** ..... **40-48**  
Gas tank full alarm 18.900 -0.3 .....  
**\$1.00 EA** ⚠

**Fog Light Installation Sheets**

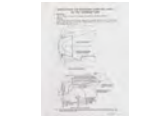

- ACC18I** ..... **41**  
18.900 -0.3 .....  
**\$2.00 EA** ⚠

- ACC40I** ..... **42-48**  
18.900 -0.15 ..... **\$2.00 EA** ⚠

**Footscrapers Installation Sheet**

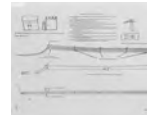

- ACC14I** ..... **41**  
18.900 -0.3 .....  
**\$2.00 EA** ⚠

**Fresh Air Kit Installation Sheet**



- ACC22I** ..... **39**  
18.900 -0.3 .....  
**\$2.00 EA** ⚠

**Gas Filter Installation Sheet**

- ACC56I** ..... **33-56**  
Genuine AC 18.900 -0.15 .. **\$2.00 EA** ⚠

**Bumper Guard Installation Sheet**



- ACC31I** ..... **37-39**  
Grille 18.900 -0.3 .....  
**\$2.00 EA** ⚠

- ACC55I** ..... **39**  
Rear fold down 18.900 -0.15 .. **\$2.00 EA**  
⚠

- ACC77I** ..... **40**  
Fender (wing tips) 18.900 -0.15 .....  
**\$2.00 EA** ⚠



- ACC36I** ..... **40-48**  
Rear fold down, original  
42 18.900 -0.3 .....  
**\$2.00 EA** ⚠



- ACC32I** ..... **41**  
Grille & front wing tips  
18.900 -0.3 ..... **\$2.00 EA**  
⚠

**Glove Compartment Lamp Installation Sheet**

- ACC02I** ..... **41-54**  
18.900 -0.15 ..... **\$1.00 EA** ⚠

**Grille Cover Installation Sheet**

- ACC33I** ..... **47-48**  
Winterguard 18.900 -0.3 .. **\$2.00 EA** ⚠

**Grille Installation Sheet**



- BODY37G** ..... **37**  
Cuts time in 1/3  
18.400 -0 .. **\$1.00 EA**  
⚠

**Heater Installation Sheet**

- ACC51I** ..... **39**  
Rear seat 18.900 -0.4 ..... **\$2.00 EA** ⚠



- ACC49I** ..... **40-49**  
Under seat 18.900 -0.15  
..... **\$2.00 EA** ⚠

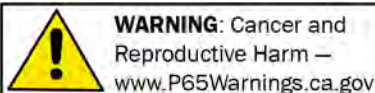

Chemicals shipped domestic ground only (Lower 48 states only). No international shipping.

Phone: (360) 816-0211 • (800) 999-CHEV (2438) • www.chevsofthe40s.com



**Town And Country Horn Installation Sheet**

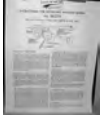

**ACC62I** ..... **37-38**  
 (Matched) with City &  
 Country switch, original  
 37 18.900-0.4 .....  
**\$2.50 EA** ⚠

**ACC09I** ..... **37-39**  
 (Matched) with City & Country switch,  
 original 39 18.900-0.4 ..... **\$2.50 EA** ⚠  
**ACC10I** ..... **40-42**  
 . 18.900-0.4 ..... **\$3.00 EA** ⚠

**Lock And Key Service Manual**

**ACC89I** ..... **ALL**  
 9 pages 18.900-0.4 ..... **\$5.00 EA** ⚠

**Luggage Compartment Lamp Installation Sheet**

**ACC01I** ..... **42-48**  
 Luggage compartment 18.900-0.15 ...  
**\$1.00 EA** ⚠

**Mirror Vanity Installation Sheet**

**ACC63I** ..... **37-41**  
 With vertical lights 18.900-0.15 .....  
**\$2.00 EA** ⚠

**Mirror Peep Installation Sheet**

**ACC53I** ..... **37-50**  
 . 18.900-0.4 ..... **\$1.00 EA** ⚠

**No Roll Hill Holder Installation Sheet**



**ACC34I** ..... **37-39**  
 . 18.900-0.3 .....  
**\$2.00 EA** ⚠



**ACC35I** ..... **41-48**  
 . 18.900-0.3 .....  
**\$2.00 EA** ⚠

**Oil Filter Installation Sheet**

**ACC88I** ..... **37-41**  
 Original AC 18.900-0.4 ..... **\$3.00 EA** ⚠



**ACC66I** ..... **42-47**  
 Original AC 18.900-0.3 .....  
**\$4.00 EA** ⚠



**ACC87I** ..... **48-49**  
 Original AC 18.900-0.2 .....  
**\$3.00 EA** ⚠



**ACC67I** ..... **50-52**  
 Original AC 18.900-0.15 .....  
**\$2.00 EA** ⚠



**ACC68I** ..... **53-55**  
 Original AC 18.900-0.15 .....  
**\$2.00 EA** ⚠

**Overflow Tank Installation Sheet**

**ACC07I** ..... **37-48**  
 Install instructions 18.900-0.3 .....  
**\$2.00 EA** ⚠

**ACC08I** ..... **49-54**  
 . 18.900-0.3 ..... **\$2.00 EA** ⚠

**Park Light Installation Sheet**



**ACC60I** ..... **37-39**  
 Fender lamps  
 18.900-0.15 .....  
**\$2.00 EA** ⚠

**Passing Lamp Installation Sheet**

**ACC19I** ..... **41**  
 . 18.900-0.3 ..... **\$2.00 EA** ⚠

**Spotlight Template**



**ASC** ..... **37-54**  
 W/ instruction (specify  
 year when ordering)  
 18.900-0.15 ... starting  
 at **\$2.00 EA** ⚠

**Steering Wheel Installation Sheet**



**ACC38I** ..... **39**  
 Banjo 18.900-0.4 ...  
**\$2.00 EA** ⚠

**Sunvisor**

**ACC57I** ..... **ALL**  
 Application chart for Fulton exterior visor.  
 18.900-0.15 ..... **\$2.00 EA** ⚠

**Turn Signal Installation Sheet**



**ACC05I** ..... **40-41**  
 Original 1940 18.900-0.4  
 ..... **\$4.00 EA** ⚠



**ACC06I** ..... **42-48**  
 This is the installation  
 sheet for the turn  
 signals. 18.900-0.4 .  
**\$4.00 EA** ⚠

**Umbrella Holder Installation Sheet**

**ACC11I** ..... **ALL**  
 This is a nice reproduction of the original  
 umbrella holder installation sheet.  
 18.900-0.3 ..... **\$2.00 EA** ⚠

**Underhood Lamp Installation Sheet**

**ACC82I** ..... **49-54**  
 . 18.900-0 ..... **\$1.00 EA** ⚠

**Utility Pocket Unit Installation Sheet**



**ACC70I** ..... **48-50**  
 . 18.900-0.15 .....  
**\$2.00 EA** ⚠

**Washboards Installation Sheet**

**ACC02T** ..... **41**  
 W/ template 18.900-0.15 . **\$5.00 EA** ⚠

**Windshield Washer Installation Sheet**

**ACC59I** ..... **38-39**  
 . 18.900-0.15 ..... **\$2.00 EA** ⚠

**ACC12I** ..... **41-42**  
 . 18.900-0.3 ..... **\$2.00 EA** ⚠

**ACC58I** ..... **49-50**  
 . 18.900-0.15 ..... **\$2.00 EA** ⚠

**Wiper Installation Sheet**

**ACC90I** ..... **41-48**  
 Rear window installation 18.900-0.15 .  
**\$2.00 EA** ⚠

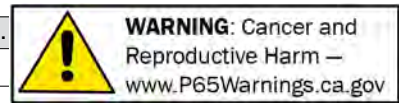

**SECTION 550C  
RESTORATION PARTS**

**Signs**



**SIGN03** .....ALL  
Chevrolet decal (as on metal sign).  
19.450 -0.15 ..... **\$33.75 EA** ⚠

**Air Cleaner**



**AIR350** .....34-39  
Oil bath decal  
19.300 -0.15 .....  
**\$7.25 EA** ⚠



**AIR37** ..... 37  
Dry decal 19.300 -0  
**\$5.50 EA** ⚠



**AIR38** .....38-48  
Dry decal 19.300 -0.15  
..... **\$9.25 EA** ⚠



**AIR400** .....40-42  
Oil bath decal 19.300 -0  
..... **\$5.25 EA** ⚠



**AIR470** .....46-48  
Oil bath decal  
19.300 -0.15 .....  
**\$4.00 EA** ⚠



**AIR49** .....49-54  
Dry decal 19.300 -0.15  
..... **\$4.00 EA** ⚠



**AIR490** .....49-54  
Oil bath decal  
19.300 -0.15 .....  
**\$12.25 EA** ⚠

**Antifreeze**



**TAG10** .....ALL  
GM tag 19.100 -0.2  
**\$13.50 EA** ⚠

**Autronic Eye**



**TAG21** .....53-59  
Instruction tag  
headlight dimmer  
19.100 -0.15 .....  
**\$3.50 EA** ⚠

**Body Number Plate**



**PLATE38** .....37-39  
On cowl end. Deluxe  
Master 19.400 -0.3  
**\$25.00 EA** ⚠

**Body Number Plate**



**PLATE41** .....40-46  
Special Deluxe (46  
Cabriolet only)  
19.400 -0.15 .....

**\$25.00 EA** ⚠

**Body By Fisher Emblem**



**PLATE01** .....33-39  
Outside right cowl  
19.400 -0.15 .....

**\$10.00 EA** ⚠



**PLATE04** .....41-48  
Seat end w/ screws  
19.400 -0.15 .....

**\$8.50 EA** ⚠

**Battery**



**TAG03** .....ALL  
Guarantee card  
19.100 -0.15 .....

**\$4.75 EA** ⚠

**Break-in Instructions**



**TAG01** .....39-47  
Card 19.100 -0.15 .....

**\$4.00 EA** ⚠



**TAG11** .....48-56  
Card 19.100 -0.15 .....

**\$4.50 EA** ⚠

**Cigar Lighter**



**TAG02** .....39-50  
Card-Casco 19.100 -0.15  
..... **\$4.00 EA** ⚠



**TAG22** .....54-58  
Tag-Rochester  
19.100 -0.15 .....

**\$8.00 EA** ⚠

**Clock**



**TAG24** .....49-50  
Electric instruction card  
19.100 -0.15 .....

**\$2.00 EA** ⚠

**Compass**



**TAG23** .....37-42  
Tag (cut in outline of  
compass) 19.100 -0.2  
..... **\$2.50 EA** ⚠

**\$2.50 EA** ⚠



**DEC12** .....37-59  
Instruction decal  
19.200 -0.15 .....

**\$3.00 EA** ⚠

**Delco Remy Metal Tag**



**PLATE07** ..... 37  
Generator, starter & distributor 19.400 -0.15  
..... **\$7.00 EA** ⚠

**Delco Remy Tag**



**PLATE05** .....38-54  
Generator, Starter or Distributor. Includes  
rivets. 19.400 -0.15 .....

**\$7.00 EA** ⚠

**Engine Valve Cover Decal**



**DEC24** .....49-52  
Blue flame, red 19.200 -0.15  
..... **\$11.75 EA**  
⚠



**DEC26** .....53-54  
Blue flame, white 19.200 -0.15  
..... **\$4.00 EA**  
⚠



**DEC31** .....53-54  
115 hp decal for standard trans (use w/  
DEC26). 19.200 -0.15 .....

**\$12.50 EA** ⚠



**DEC32** .....53-54  
125 hp decal automatic trans (use w/  
DEC26) 19.200 -0.15 .....

**\$10.75 EA** ⚠

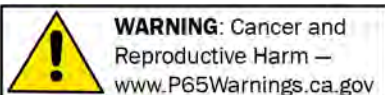

Chemicals shipped domestic ground only (Lower 48 states only). No international shipping.

Phone: (360) 816-0211 • (800) 999-CHEV (2438) • www.chevsofthe40s.com



**Generator Warning Tag**



**TAG04** ..... **ALL**  
Nice reproduction of the warning tag that was originally installed on the generator. 19.100 -0.3  
..... **\$3.75 EA** ⚠

**Heater**



**DEC06** ..... **42-54**  
On/off defroster decal 19.200 -0.15  
..... **\$3.00 EA** ⚠



**TAG17** ..... **49-50**  
Operation card 19.100 -0.15  
..... **\$9.00 EA** ⚠



**DEC29** ..... **49-51**  
Decal-Harrison 19.200 -0.15  
..... **\$11.25 EA** ⚠

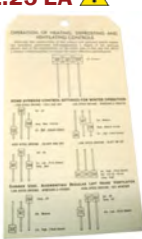

**TAG28** ..... **51-52**  
Operation card 19.100 -0.15  
..... **\$9.00 EA** ⚠



**DEC27** ..... **53-54**  
Decal 19.200 -0.15  
..... **\$7.75 EA** ⚠



**TAG27** ..... **53-54**  
Operation card air flow heater 19.100 -0.15  
..... **\$4.99 EA** ⚠

**Jack Instruction Card**



**TAG05** ..... **37-39**  
. 19.100 -0.15  
..... **\$4.00 EA** ⚠



**TAG18** ..... **40**  
. 19.100 -0.15  
..... **\$4.50 EA** ⚠

**Jack Instruction Card, cont.**



**TAG06** ..... **41**  
. 19.100 -0.4  
..... **\$4.00 EA** ⚠

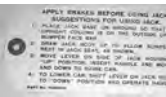

**TAG20** ..... **49-52**  
. 19.100 -0.15  
..... **\$4.00 EA** ⚠



**TAG19** ..... **53**  
. 19.100 -0.15  
..... **\$4.00 EA** ⚠



**TAG07** ..... **54**  
. 19.100 -0.15  
..... **\$4.50 EA** ⚠

**Key Decal**



**DEC11** ..... **36-54**  
Glove box 19.200 -0.2  
..... **\$4.50 EA** ⚠

**Lubrication Sticker**



**DEC05** ..... **ALL**  
Chevrolet script (blue, yellow & white) 19.200 -0.15  
..... **\$4.75 SET** ⚠

**Mirror Glare Proof**



**TAG09** ..... **ALL**  
Day-night card hangs on mirror arm (nice!) 19.100 -0.2  
..... **\$2.50 EA** ⚠

**Oil Filter**



**DEC30** ..... **37-41**  
Decal. Original, AC Kleeer Kleeen 19.200 -0.15  
..... **\$9.75 EA** ⚠



**DEC19** ..... **40-49**  
Decal set (1940's) Fram 3-piece 19.200 -0.15  
..... **\$8.00 EA** ⚠

**Oil Filter, cont.**



**DEC04** ..... **42-54**  
Decals-set of 2, original AC 19.200 -0  
..... **\$5.50 EA** ⚠



**DEC20** ..... **50-59**  
Decal set (1950's) Fram 4-piece 19.200 -0.15  
..... **\$12.00 EA** ⚠

**Overflow Tank Decal**



**DEC03** ..... **39-48**  
Gold with red wings. 19.200 -0.4  
..... **\$6.50 EA** ⚠



**DEC28** ..... **49-54**  
Clear with orange lettering. 19.200 -0.15  
..... **\$11.25 EA** ⚠

**Paint Lacquer**

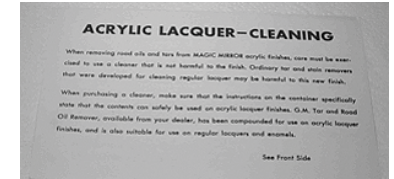

**TAG16** ..... **53-58**  
Instruction card 19.100 -0.2  
..... **\$6.00 EA** ⚠

**Power Steering**

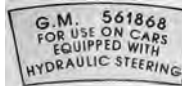

**DEC22** ..... **53-54**  
Pulley decal 19.200 -0.15  
..... **\$9.00 EA** ⚠

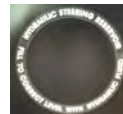

**DEC23** ..... **53-54**  
Lid decal 19.200 -0.15  
..... **\$9.00 EA** ⚠

**Powerglide Instructions**



**TAG26** ..... **50-54**  
Sleeve goes on visor 19.100 -0.15  
..... **\$9.50 EA** ⚠



**Section 560C: Books**

**Quality Control Card**



**TAG15 . . . . .49-54**  
 Reproduction of the 1949-54 quality control card.  
 19.100-0.2  
 . . . . . **\$12.00 EA** ⚠

**Service Policy**



**TAG25 . . . . .37-51**  
 Reproduction of the 1937-51 service policy card.  
 19.100-0.2  
 . . . . . **\$6.00 EA** ⚠



**TAG13 . . . . .51-59**  
 Reproduction of the 1951-59 service policy card.  
 19.100-0.15  
 . . . . . **\$4.00 EA** ⚠

**Spotlight Card**



**TAG08 . . . . .37-54**  
 Original S3-S4 hung on light 19.100-0.4  
 . . . . . **\$3.00 EA** ⚠

**Top Motor**



**PLATE06 . . . .46-50**  
 Duro metal tag w/ rivets 19.400-0

**CALL** ⚠

**Warranty Card**



**TAG14 . . . . .54-60**  
 Reproduction of an impossible to find warranty card.  
 19.100-0.15  
 . . . . . **\$4.00 EA** ⚠

**Windshield Washer**



**DEC02 . . . . .39-50**  
 Decal on metal basket 19.200-0.15  
 . . . . . **\$4.00 EA** ⚠



**DEC13 . . . . .51-54**  
 Lid decal 19.200-0.15 . . . . . **\$11.25 EA** ⚠



**DEC14 . . . . .51-54**  
 Basket decal 19.200-0.15  
 . . . . . **\$10.75 EA** ⚠

**Tire Pump Decal**



**DEC34 . . . . .ALL**  
 For hard to find genuine Chevrolet accessory. By Monroe -0.2 **\$5.00 EA** ⚠

**SECTION 560C RESTORATION PARTS**

**Hemmings Collector Car Encyclopedia**



**HEMMINGPEDIA . ALL**  
 Hemmings Collector Car Encyclopedia -0.15  
**\$14.00 EA** ⚠

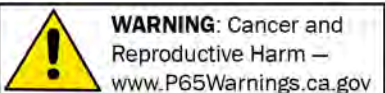

**WARNING: Cancer and Reproductive Harm** —  
[www.P65Warnings.ca.gov](http://www.P65Warnings.ca.gov)

Chemicals shipped domestic ground only (Lower 48 states only). No international shipping.

**Phone: (360) 816-0211 • (800) 999-CHEV (2438) • www.chevsofthe40s.com**



**SECTION 570C  
RESTORATION PARTS**

12in. x 18in. pictures of your favorite cars.  
Super high quality, showing cars & scenes as they were.

**Engineering Photos**



**FOT037E..... 37**  
Set of 7 19.600 -0.15 ..... **\$17.00 SET** ⚠



**FOT041EF ..... 41**  
Set of 7 (Fleetline) 19.600 -0.15 .....  
**\$25.00 SET** ⚠



**FOT041EM..... 41**  
Set of 7 (Master Deluxe) 19.600 -0.15 ...  
**\$25.00 SET** ⚠



**FOT041ES ..... 41**  
Set of 7 (Special Deluxe) 19.600 -0.15 ...  
**\$25.00 SET** ⚠

**1937 Photos (12in.x18in.)**

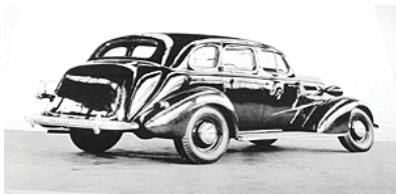

**FOT037..... 37**  
4-door, 3/4 rear view 19.600 -0.15 .....  
**\$4.50 EA** ⚠

**1937 Photos (12in.x18in.), cont.**



**FOT037A..... 37**  
Convertible coupe 19.600 -0.2 ..... **\$5.00 EA**  
⚠



**FOT037B ..... 37**  
Accessories 19.600 -0.2 ..... **\$5.00 EA** ⚠



**FOT037C ..... 37**  
Interior 19.600 -0.15 ..... **\$4.75 EA** ⚠



**FOT037D ..... 37**  
2-Door, front view 19.600 -0.15 ..... **\$4.75 EA**  
⚠



**FOT037F..... 37**  
Convertible 19.600 -0.15 ..... **\$4.75 EA** ⚠



**FOT037G ..... 37**  
Long wheelbase Taxi 19.600 -0.2 .....  
**\$5.00 EA** ⚠

**1937 Photos (12in.x18in.), cont.**



**FOT037H ..... 37**  
New car dealer showroom 19.600 -0.2 .....  
**\$5.00 EA** ⚠



**FOT037I ..... 37**  
Chev with babes 19.600 -0.15 ..... **\$4.75 EA**  
⚠



**FOT037J ..... 37**  
Chevrolet assembly line, buffing  
19.600 -0.15 ..... **\$4.75 EA** ⚠



**FOT037K ..... 37**  
Chevrolet parts counter 19.600 -0.15 .....  
**\$4.75 EA** ⚠



**FOT037N ..... 37**  
Late 30's part counter 19.600 -0.2 .....  
**\$5.00 EA** ⚠



**FOT037O ..... 37**  
Cabriolet 19.600 -0.2 ..... **\$5.00 EA** ⚠

**1938 Photos (12in.x18in.)**



**FOT038** ..... 38  
 Dealer showroom with 2-door & 6 others  
 with skirts, fender lights & spotlights  
 19.600 -0.2 ..... **\$6.50 EA** ⚠



**FOT038A** ..... 38  
 4-door sedan 19.600 -0.2 ... **\$5.00 EA** ⚠



**FOT038B** ..... 38  
 2-door trunk back 19.600 -0.15 ..... **\$4.75 EA** ⚠



**FOT038C** ..... 38  
 Cabriolet 19.600 -0.2 ..... **\$5.00 EA** ⚠



**FOT038D** ..... 38  
 Showroom 19.600 -0.2 ..... **\$5.00 EA** ⚠



**FOT038F** ..... 38  
 Dealer parts showroom 19.600 -0.2 .....  
**\$5.00 EA** ⚠

**1938 Photos (12in.x18in.), cont.**



**FOT038G** ..... 38  
 Long wheel base taxi 19.600 -0.2 .....  
**\$5.00 EA** ⚠



**FOT038H** ..... 38  
 Dealer showroom window at christmas  
 19.600 -0.15 ..... **\$4.75 EA** ⚠



**FOT038I** ..... 38  
 Genuine Chevrolet approved accessories  
 19.600 -0.2 ..... **\$5.00 EA** ⚠



**FOT038J** ..... 38  
 Accessory display 19.600 -0.2 ..... **\$5.00 EA**  
 ⚠



**FOT038K** ..... 38  
 Chevrolet dealer showroom 19.600 -0.15  
**\$4.75 EA** ⚠



**FOT038L** ..... 38  
 Chevrolet sedan in service department  
 19.600 -0.2 ..... **\$5.00 EA** ⚠

**1938 Photos (12in.x18in.), cont.**



**FOT038M** ..... 38  
 Chevrolet in Chevrolet dealer 19.600 -0.15  
 ..... **\$4.75 EA** ⚠



**FOT038N** ..... 38  
 Chevrolet 4 door at Texaco gas station  
 19.600 -0.2 ..... **\$5.00 EA** ⚠

**1939 Photos (12in.x18in.)**

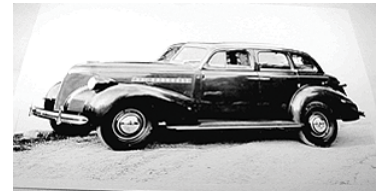

**FOT039** ..... 39  
 4-door sedan-Master Deluxe 19.600 -0.15  
 ..... **\$4.50 EA** ⚠



**FOT039A** ..... 39  
 2-door sedan 19.600 -0.15 ..... **\$4.75 EA** ⚠



**FOT039B** ..... 39  
 Club coupe-Master Deluxe 19.600 -0.2 .....  
**\$5.00 EA** ⚠



**FOT039C** ..... 39  
 Dealer Showroom 19.600 -0.2 ..... **\$5.00 EA**  
 ⚠

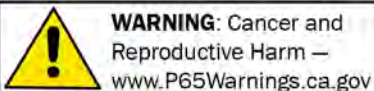



**1940 Photos (12in.x18in.)**



**FOTO40** ..... 40  
Coupe-Special Deluxe 19.600 -0.15 .....  
\$4.75 EA ⚠



**FOTO40A** ..... 40  
Cabriolet side view 19.600 -0.2 ..... \$5.00 EA  
⚠



**FOTO40B** ..... 40  
Cabriolet with people 19.600 -0.2 .....  
\$5.00 EA ⚠

**1941 Photos (12in.x18in.)**



**FOTO41** ..... 41  
4-door sedan-Special Deluxe 19.600 -0.2 .....  
\$5.00 EA ⚠



**FOTO41A** ..... 41  
2-door Deluxe 19.600 -0.15 ..... \$4.75 EA ⚠



**FOTO41B** ..... 41  
Sedan Delivery 19.600 -0.2 ..... \$5.00 EA ⚠

**1941 Photos (12in.x18in.)**



**FOTO41C** ..... 41  
Chevrolet assembly line  
19.600 -0.15 ..... \$4.75 EA  
⚠

**1942 Photos (12in.x18in.)**



**FOTO42** ..... 42  
2-door Fastback Fleetline 19.600 -0.2 .....  
\$5.00 EA ⚠

**1946 Photos (12in.x18in.)**



**FOTO46** ..... 46  
4-door Fleetline 19.600 -0.15 ..... \$4.50 EA  
⚠



**FOTO46A** ..... 46  
Dealer parts showroom 19.600 -0.15 .....  
\$4.75 EA ⚠

**1947 Photos (12in.x18in.)**



**FOTO47A** ..... 47  
Dealer parts showroom 19.600 -0.15 .....  
\$4.75 EA ⚠

**1947-48 Photos (12in.x18in.)**



**FOTO47C** ..... 47-48  
Fleetmaster Station Wagon 19.600 -0.15 .....  
\$4.50 EA ⚠

**1947-48 Photos (12in.x18in.), cont.**



**FOTO47D** ..... 47-48  
4-door Fleetmaster Sedan 19.600 -0.15 .....  
\$4.75 EA ⚠

**1948 Photos (12in.x18in.)**



**FOTO48** ..... 48  
2-door Fleetline-artists' concept 19.600 -0.15 .....  
\$4.75 EA ⚠



**FOTO48B** ..... 48  
Sedan Delivery 19.600 -0.2 ..... \$5.00 EA  
⚠

**1949 Photos (12in.x18in.)**



**FOTO49** ..... 49  
4-door 19.600 -0.15 ..... \$4.50 EA ⚠



**FOTO49A** ..... 49  
4-door Fleetline with jet fighter 19.600 -0.15 .....  
\$4.75 EA ⚠



**FOTO49B** ..... 49  
Hardtop 19.600 -0.2 ..... \$5.00 EA ⚠

**1950 Photos (12in.x18in.)**

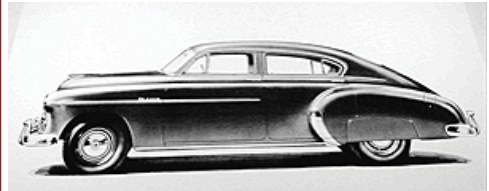

**FOTO50** ..... 50  
4-door Fleetline 19.600 -0.2 ..... \$5.00 EA ⚠



**1950 Photos (12in.x18in.), cont.**

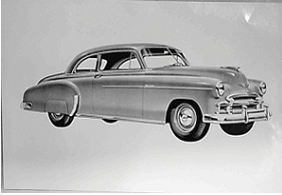

**FOT050A** ..... 50  
 Styleline Deluxe Coupe 19.600 -0.15 .....  
**\$4.75 EA** ⚠



**FOT050B** ..... 50  
 Convertible 19.600 -0.15 ... **\$4.75 EA** ⚠



**FOT050C** ..... 50  
 4-door sedan 19.600 -0.2 .. **\$5.00 EA** ⚠



**FOT050D** ..... 50  
 Wagon 19.600 -0.2 ..... **\$5.00 EA** ⚠



**FOT050E** ..... 50  
 2-door Hardtop 19.600 -0.2 **\$5.00 EA** ⚠



**FOT050F** ..... 50  
 2-door Hardtop w/ people 19.600 -0.15  
**\$4.50 EA** ⚠

**1950 Photos (12in.x18in.), cont.**



**FOT050G** ..... 50  
 Showroom accessories display  
 19.600 -0.15  
 ..... **\$4.75 EA** ⚠

**1951 Photos (12in.x18in.)**



**FOT051** ..... 51  
 2-door Hardtop 19.600 -0.15 .. **\$4.75 EA**  
 ⚠



**FOT051A** ..... 51  
 Sedan Delivery 19.600 -0.2 .. **\$5.00 EA** ⚠



**FOT051B** ..... 51  
 4-door 19.600 -0.2 ..... **\$5.00 EA** ⚠



**FOT051C** ..... 51  
 2-door Fleetline 19.600 -0.2 **\$5.00 EA** ⚠



**FOT051D** ..... 51  
 Convertible 19.600 -0.2 ..... **\$5.00 EA** ⚠

**1951 Photos (12in.x18in.), cont.**



**FOT051E** ..... 51  
 2-door Hardtop 19.600 -0.15 .. **\$4.75 EA**  
 ⚠



**FOT051F** ..... 51  
 4-door Sedan Deluxe 19.600 -0.2 .....  
**\$5.00 EA** ⚠

**1952 Photos (12in.x18in.)**



**FOT052** ..... 52  
 2-door sedan 19.600 -0.2 .. **\$5.00 EA** ⚠



**FOT052A** ..... 52  
 4-door 19.600 -0.2 ..... **\$5.00 EA** ⚠



**FOT052B** ..... 52  
 4-door Station Wagon 19.600 -0.2 .....  
**\$5.00 EA** ⚠



**FOT052C** ..... 52  
 2-door Hardtop Deluxe 19.600 -0.2 .....  
**\$5.00 EA** ⚠



**WARNING: Cancer and Reproductive Harm** —  
[www.P65Warnings.ca.gov](http://www.P65Warnings.ca.gov)

Chemicals shipped domestic ground only (Lower 48 states only). No international shipping.

**Phone: (360) 816-0211 • (800) 999-CHEV (2438) • www.chevs40s.com**



# Section 570C: Photos

## 1952 Photos (12in.x18in.), cont.



**FOT052D** ..... 52  
 2-door Deluxe trunk-back sedan 19.600 -0.2  
 ..... **\$5.00 EA** ⚠

## 1953 Photos (12in.x18in.)



**FOT053** ..... 53  
 Showroom picture w/ convertible, Hardtop, 210 4-door, 150 2-door & Golden Gate bridge 19.600 -0.15  
 ..... **\$4.75 EA** ⚠



**FOT053A** ..... 53  
 Sedan delivery 19.600 -0.2 ..... **\$5.00 EA** ⚠



**FOT053B** ..... 53  
 Convertible 19.600 -0.2 ..... **\$5.00 EA** ⚠



**FOT053C** ..... 53  
 4-door 19.600 -0.3 ..... **\$5.00 EA** ⚠



**FOT053D** ..... 53  
 4-door, 3/4 front view 19.600 -0.2 .....  
**\$5.00 EA** ⚠

## 1954 Photos (12in.x18in.)



**FOT054** ..... 54  
 4-door, artists rendering 19.600 -0.15 ...  
**\$4.75 EA** ⚠



**FOT054A** ..... 54  
 4-door with people 19.600 -0.2 ..... **\$5.00 EA**  
 ⚠



**FOT054B** ..... 54  
 Motorama display. 19.600 -0.15 .....  
**\$4.75 EA** ⚠



**A**

ADHESIVES & SEALERS..... 29-30, 245, 255  
 AIR CLEANERS..... 93-94, 269  
 AIR CONDITIONING..... 51  
 AIR DUCTS..... 164, 184  
 AIR FILTERS..... 96, 99, 101  
 ALTERNATORS..... 57-58  
 ALUMINUM BUNDLE STRAP..... 52, 69  
 ANTENNAS..... 209  
 ARM RESTS..... 220  
 ASH TRAYS..... 195, 201-202  
 AUTO LITERATURE..... 31, 66, 264, 271

**B**

BACK GLASS..... 235-236, 247-248, 258  
 BACKUP LIGHTS..... 92  
 BATTERY & RELATED..... 28, 31, 57, 59-60, 193, 269  
 BEAUTY RINGS..... 138  
 BODY BOLTS..... 189  
 BODY BY FISHER EMBLEM..... 269  
 BODY MOUNTING COMPONENTS..... 189, 193  
 BODY NUMBER PLATES..... 269  
 BOLT LOOSENER..... 29, 31  
 BRAKE CLEANER..... 29  
 BRAKE FLUID..... 29, 118  
 BRAKE LIGHTS..... 122  
 BRAKE LINES..... 120  
 BRAKE OVERHAUL KITS..... 119  
 BRAKE PEDAL..... 192  
 BRAKE PEDALS..... 192  
 BRAKES & RELATED..... 118-123, 139  
 BULBS..... 79-82  
 BULBS-HALOGEN..... 79-80  
 BULBS-HEADLIGHT..... 79-81  
 BULBS-LED..... 79-80  
 BULBS-SPOTLIGHT..... 80  
 BULK TUBING..... 31  
 BUMPER BOLTS..... 143  
 BUMPER BRACKETS..... 141, 143-144  
 BUMPER GUARDS..... 142-143

**C**

CABRIOLET PARTS..... 201, 227, 250, 256, 258-264, 271  
 CAM & LIFTER KITS..... 36  
 CAMSHAFTS..... 39-40  
 CAR CARE..... 24-27, 139  
 CAR COVERS..... 27  
 CAR WASH, WAX, CLEANERS..... 27  
 CAR WASH,WAX,CLEANERS..... 26  
 CARBURETORS..... 29, 99-101  
 CARPET & RELATED..... 193, 196, 255  
 CHOKE CABLES..... 200  
 CHOKE KNOBS..... 200  
 CHOKE TUBES..... 101  
 CIGAR LIGHTERS..... 269  
 CIGARETTE LIGHTERS..... 202, 269  
 CLIPS..... 68, 170-172, 194, 220, 243  
 CLIPS-MOULDING..... 171-172  
 CLIPS-WIRE..... 68  
 CLIPS, MOULDING CLIPS..... 170

CLOCKS & RELATED..... 199, 207, 269  
 CLOTHING..... 21-22  
 CLUTCH & RELATED..... 109  
 CLUTCH HEAD DRIVER..... 30, 77  
 CLUTCH HEAD SOCKET SET..... 77  
 CLUTCH PEDAL..... 192  
 CLUTCH PEDALS..... 192  
 COAT HOOKS..... 195  
 COLLECTIBLES..... 20, 22, 24  
 COMPLETE FLOOR..... 182  
 CONDENSERS..... 62  
 CONTINENTAL KITS..... 141-142  
 CONVERTIBLE PARTS..... 201, 227, 250, 256, 258-264, 271  
 CONVERTIBLE TOPS..... 259  
 CORE SUPPORTS..... 151-152, 161  
 COWL PANELS..... 174-175, 177, 180  
 COWL VENTS..... 53, 175, 199  
 CRANK..... 55, 148-150, 248-250  
 CRANK HOLE COVERS..... 148-150  
 CURB FEELERS..... 163

**D**

DASH & RELATED..... 204-205, 207  
 DECALS..... 269-271  
 DEFROSTER..... 53  
 DIMMER SWITCH..... 79  
 DISC BRAKES..... 117  
 DISTRIBUTORS..... 61-62  
 DOME LIGHTS..... 194-195  
 DOOR 171, 174-175, 177-178, 180-181, 183, 186, 194, 220-227, 231-233, 245-246, 258-259, 261-262  
 DOOR BUMPERS..... 227, 262  
 DOOR CHECK LINKS..... 224-225  
 DOOR GLASS & RELATED..... 231-233, 245, 261  
 DOOR HANDLES..... 220-221, 223-224  
 DOOR HINGES..... 224  
 DOOR LATCHES..... 222-223  
 DOOR LOCKS..... 220-223  
 DOOR PANELS..... 194  
 DOOR PATCH PANELS..... 174, 177, 180, 183  
 DOOR POSTS..... 183  
 DOOR PULLS..... 220  
 DOOR WEATHERSTRIP..... 225-227, 246, 258-259, 262  
 DOORS..... 171, 175, 178, 181, 186, 225  
 DRAG LINKS..... 127  
 DRIVE SHAFTS..... 114  
 DRIVING LIGHTS..... 73, 80  
 DROPPED UPRIGHTS..... 130

**E**

EMERGENCY BRAKES..... 119  
 ENGINE & DRIVETRAIN TOOLS..... 30  
 ENGINE ASSEMBLY LUBE..... 40, 44  
 ENGINE COMPONENTS..... 37-41  
 ENGINE CRANK..... 55  
 ENGINE GASKETS & SEALS..... 43-44  
 ENGINE KITS..... 36  
 ESCUTCHEONS..... 195, 223, 249  
 EXHAUST & RELATED..... 93, 103-106  
 EXHAUST MANIFOLDS..... 101

NOTE: Any chemicals will be shipped domestic ground only (Lower 48 states only). No international shipping.



**F**

FAN ..... 49, 51, 199

FENDER BAFFLES ..... 161

FENDER GRILLES ..... 149, 159

FENDER GUARDS ..... 142

FENDER MOULDINGS ..... 20, 171

FENDER SKIRTS ..... 165

FENDERS ..... 159, 161-164, 172, 182, 184-186, 189

FIREWALL & RELATED ..... 175, 178, 181, 184, 190-191, 259

FLASHLIGHT ..... 195

FLOOR BRACES ..... 180, 183-184, 186-187

FLOOR MATS ..... 192, 255-256

FLOOR PANS ..... 181, 185

FLOORBOARD PARTS ..... 192

FLOORBOARDS ..... 175-176, 178, 181-182, 184-187, 192-193

FLYWHEEL RING GEAR ..... 109

FOG LIGHTS ..... 73-74, 80-81

FOOT ..... 169, 173, 181

FOOT SCRAPERS ..... 169, 181

FRONT BUMPERS ..... 141-143, 145

FRONT END REBUILD KITS ..... 131

FRONT SUSPENSION ..... 130-132

FUEL ..... 28-29, 93-96, 98-99, 101, 215

FUEL FILTERS ..... 98

FUEL LINES ..... 101

FUEL PUMPS ..... 93, 99, 215

FUEL SENDING UNITS ..... 96, 98

FUEL STABILIZERS ..... 28-29, 95

FUEL SYSTEM ..... 98-99

FUSE HOLDERS ..... 69, 74

**G**

GARNISH MOULDING CLIPS ..... 170, 194, 220

GARNISH MOULDING INSERT ..... 220

GAS CAPS ..... 97

GAS FILLER ..... 97-98

GAS PEDALS ..... 192-193

GAS TANK PREP & SEALER ..... 28-29

GAS TANK SEALER SLOSH ..... 95

GAS TANK SENDING UNITS ..... 96, 98

GAS TANKS ..... 43, 94-98

GEARSHIFT CONVERSION KIT ..... 112

GENERATORS ..... 59, 270

GIFTS ..... 20, 22, 24

GLOVE BOXES ..... 207-208

GRAVEL SHIELDS ..... 159

GREASE FITTINGS ..... 131, 135

GRILLE ..... 148-152, 159

GRILLES ..... 148-152, 159

GROUND STRAPS ..... 60, 213

**H**

HAND CRANK ..... 55

HAT HOLDER ..... 195

HEADLIGHT ..... 67, 75-81, 164, 200

HEADLIGHTS ..... 75-80, 164, 200

HEADLINERS ..... 196

HEATER ..... 51-53, 68, 270

HEATER & RELATED ..... 51-53

HOG RINGS ..... 196

HOOD & RELATED ..... 153-158, 201

HORNS & RELATED ..... 63-65, 68, 126, 199-200

HUB CAPS ..... 137-139

**I**

IFS ..... 130

IGNITION & RELATED ..... 61-63, 201

INSTRUMENT GAUGES & RELATED ..... 205-207

INSULATION ..... 32, 191-192

INTAKE MANIFOLDS ..... 93, 101

INTAKE SYSTEMS ..... 93

INTERIOR LIGHTS ..... 194

INTERIOR SCREW SETS ..... 194

**J**

JUNCTION BLOCKS ..... 69

**K**

KEY BLANKS ..... 63, 208, 221, 253

KING PINS ..... 132

**L**

LEAF SPRINGS ..... 132-133, 135

LICENSE ..... 90-92, 141-142, 144-145, 252-253

LICENSE GUARDS ..... 141-142

LICENSE LIGHTS ..... 91-92, 253

LICENSE PLATES & RELATED ..... 90, 141, 144-145, 252

LIFTERS ..... 39

LIFTGATE ..... 252

LINE CLAMPS ..... 94, 111, 118-119

LINK PINS ..... 131

LOWERING KITS ..... 133

LUBRICATOR ..... 29, 31

LUG NUTS ..... 139-140

**M**

MAIN BEARINGS ..... 38

MANUALS ..... 264-271

MASTER CYLINDERS ..... 118, 120-121

METAL POLISH ..... 25

METAL PREP ..... 29, 96

MIRRORS ..... 202-203, 260

MOTOR MOUNTS ..... 45

MOULDING ..... 20, 168-173, 194, 220, 241

**O**

OAKIE BUSHINGS ..... 114-115

OIL & COMPONENTS ..... 41-42

OIL PRESSURE LINES ..... 207

OIL PUMPS & RELATED ..... 41-42

OIL TROUGH ALIGNMENT TOOL ..... 41

ORIGINAL CARDS ..... 270-271

**P**

PAINTS ..... 32-33, 53, 208, 270

PARK ..... 71-73

PARK LIGHTS ..... 71-73

PETCOCK ..... 47

PHOTOS ..... 272-276

PILOT BEARINGS ..... 109  
 PILOT BUSHINGS ..... 109  
 PINION BEARINGS ..... 115  
 PISTON & RING KITS ..... 36, 38  
 PISTONS ..... 38  
 PITMAN ARMS ..... 126  
 PITMAN SHAFTS ..... 125-126  
 PLASTIC BLOCK ..... 27-28  
 PLASTIGAUGE ..... 38  
 POINTS ..... 62  
 POWER STEERING ..... 125, 270  
 POWER WINDOWS ..... 248  
 PRESSURE ..... 109, 207  
 PRESSURE PLATES ..... 109  
 PUSHRODS ..... 39

**Q**  
 QUARTER WINDOWS ..... 233-235, 246-247, 261-262

**R**  
 RADIATORS ..... 46-48, 152  
 RADIOS ..... 209-213  
 REAR ..... 115, 133, 135-136, 141-143, 145, 186, 256, 258  
 REAR AXLE ..... 115  
 REAR BUMPERS ..... 141-143, 145  
 REAR DIFFERENTIAL ..... 115  
 REAR SUSPENSION ..... 133, 135-136  
 REVEAL MOULDINGS ..... 171  
 REVERSE POLARITY SWITCH ..... 55, 62, 68  
 RING ..... 36, 38, 109, 115, 138, 193, 196  
 RING & PINION ..... 115  
 ROCKER ARMS ..... 39  
 ROCKER MOULDINGS ..... 168-169, 172-173  
 ROCKER PANELS ..... 169, 174-178, 180-181, 183-184, 186-187  
 ROD BEARINGS ..... 38  
 ROD DIPPER ..... 38  
 ROD SERVICE ..... 38  
 ROLLER BEARING CONVERSION ..... 140  
 ROOF RAIL ..... 244, 260  
 ROTORS ..... 62  
 RUBBER ..... 239-242  
 RUMBLE SEAT COMPONENTS ..... 164, 254  
 RUNNING BOARDS ..... 167-168, 172, 175-176, 178-179  
 RUST TREATMENT ..... 29

**S**  
 SEATS ..... 182, 186, 196, 199  
 SETTING TAPE ..... 242, 262  
 SHACKLES ..... 132, 135  
 SHEETMETAL ..... 174, 177, 180-181, 183-184, 186-187  
 SHIFT ..... 111-112, 193, 201, 207  
 SHIFT INDICATORS ..... 111  
 SHIFT KNOBS ..... 111, 201  
 SHIFTERS ..... 111-112, 193  
 SHOCKS-FRONT ..... 132  
 SHOCKS-REAR ..... 135-136  
 SILL PLATES ..... 166-167  
 SPARE TIRE WELLS ..... 180, 183, 186  
 SPARK PLUG WIRES ..... 61  
 SPARK PLUGS ..... 61  
 SPEEDOMETERS ..... 113, 207

SPINDLE NUT ..... 140  
 SPLASH APRONS ..... 144, 182, 185  
 SPOTLIGHTS ..... 74  
 STARTERS & RELATED ..... 55-56, 193, 199  
 STEERING ARMS ..... 130  
 STEERING COLUMNS & RELATED ..... 123, 125-127, 191, 199  
 STEERING WHEELS ..... 63, 65  
 STOVE BOLTS ..... 40  
 STUD ..... 262  
 SUNVISORS ..... 197-198, 260  
 SUSPENSION BUMPERS ..... 131-132, 135  
 SWAY BARS ..... 131, 133  
 SWITCHES ..... 74

**T**  
 TACKING STRIP ..... 198, 260  
 TAGS-ANTIFREEZE ..... 269  
 TAGS-AUTRONIC EYE ..... 269  
 TAGS-COMPASS ..... 269  
 TAGS-DELCO REMY ..... 269  
 TAGS-HEATER ..... 270  
 TAGS-JACK ..... 270  
 TAGS-SPOTLIGHT ..... 271  
 TAIL LIGHTS ..... 82-91  
 TEMPERATURE GAUGE ..... 207  
 TERMINAL BOARDS ..... 69, 78  
 THERMOSTATS ..... 48  
 THROTTLE CABLES & RELATED ..... 101, 200-201  
 THROWOUT ARM & BEARING ..... 109  
 TIE RODS ..... 126  
 TIMING CHAINS ..... 44  
 TIMING COVER ..... 40  
 TIMING GEARS ..... 40  
 TIMING HOLE PLUG ..... 40, 62  
 TIRES ..... 139  
 TISSUE DISPENSERS ..... 202  
 TOE BOARDS ..... 178, 181-182, 185  
 TOOL BAG ..... 30  
 TOOL TRAYS ..... 174, 177  
 TOOLS ..... 28, 30-31  
 TOP ..... 259  
 TORQUE TUBES ..... 114  
 TRAFFIC LIGHT VIEWERS ..... 199  
 TRANSMISSIONS & COMPONENTS ..... 46, 111-113, 175, 178, 181-182, 193  
 TRIM RINGS ..... 193  
 TRUNK & RELATED ..... 176, 179, 181-187, 252-255  
 TRUNK FLOOR MATS ..... 255-256  
 TUBE CLAMPS ..... 66  
 TURN SIGNALS ..... 70-71

**U**  
 U-BOLTS ..... 132, 135  
 U-JOINTS ..... 114

**V**  
 VACUUM ADVANCE LINES ..... 101  
 VACUUM ADVANCES ..... 62  
 VACUUM SHIFT ..... 112  
 VALVE COVERS ..... 37, 43  
 VALVE STEMS ..... 139  
 VEHICLE ACCESSORIES ..... 20-21

NOTE: Any chemicals will be shipped domestic ground only (Lower 48 states only). No international shipping.



VENT CRANKS ..... 250  
 VENT FRAMES ..... 242  
 VENT GLASS ..... 230-231, 233  
 VENT WINDOW & RELATED ..... 242-244, 246, 249  
 VENTS ..... 53, 175, 199  
 VOLTAGE BOOSTERS ..... 205, 209, 214  
 VOLTAGE CUT OUTS ..... 59  
 VOLTAGE REDUCERS ..... 96, 205  
 VOLTAGE REGULATORS ..... 59-60

**W**  
 WALL CLOCKS ..... 22-24  
 WALL SIGNS ..... 24, 269  
 WATER ..... 27, 48-49  
 WATER PUMPS ..... 48-49  
 WEATHERSTRIP ..... 225-227, 246, 258-260, 262  
 WHEEL BEARING DUST COVER ..... 140  
 WHEEL BEARINGS ..... 140  
 WHEEL COVERS ..... 138  
 WHEEL CYLINDERS ..... 121-122  
 WHEEL DISCS ..... 138-139  
 WHEELS ..... 63, 65, 136-137  
 WINDLACE ..... 197, 199, 227  
 WINDOW CHANNELS ..... 244, 246-247, 249

WINDOW COMPONENTS ..... 246  
 WINDOW CRANKS ..... 248-250  
 WINDOW FLIPPERS ..... 220, 259  
 WINDOW REGULATORS ..... 248  
 WINDOW ROLLER & RIVETS ..... 249  
 WINDOW SHADES ..... 198, 244  
 WINDSHIELD ..... 199, 214-217, 228-230, 239-242  
 WINDSHIELD MOULDINGS ..... 241  
 WINDSHIELD RUBBERS ..... 239-242  
 WINDSHIELD WASHERS ..... 217  
 WINDSHIELD WIPERS ..... 199, 214-217  
 WINDSHIELDS ..... 228-230, 239  
 WIRE CLAMPS ..... 66  
 WIRE HARNESSSES ..... 66-68  
 WIRE HARNESSSES-BACK UP LIGHT ..... 68  
 WIRE HARNESSSES-HEADLIGHT ..... 67  
 WIRE HARNESSSES-HEATER ..... 68  
 WIRE HARNESSSES-POWERGLIDE ..... 68  
 WIRE HARNESSSES-TAIL LIGHT ..... 67-68  
 WIRE LOOMS ..... 61, 68  
 WIRE STOPS ..... 157, 201  
 WIRE-BULK ..... 68, 74



**Need the latest and greatest parts for your street rod? Ask for our latest Street Rod Headquarters catalog. Call us at 800-952-1752 or visit us on the web at [www.streetrodhq.com](http://www.streetrodhq.com).**

**Call for your copy of our Truck Catalog!**

**CHEVS OF THE 40'S**  
*World's most complete supplier of 1937-54 Chevrolet car & truck parts.*  
**TRUCK CATALOG**

Order:  
 1-800-999-CHEV (2438)  
 1-360-816-0211  
 Fax: 1-800-888-CHEV (2438)  
 \$4.50 There's no one else out there!

1-800-999-CHEV(2438)  
 Shop online: [www.chevsofthe40s.com](http://www.chevsofthe40s.com)

# 1937-54 CHEVROLET CAR GRILLE GUIDE







**CHEVS OF THE 40'S**  
1605 NE 112th St.  
Vancouver, WA 98686  
800-999-2438

PRSR STD  
US POSTAGE  
PAID  
CHEVS OF 40'S  
VANCOUVER, WA

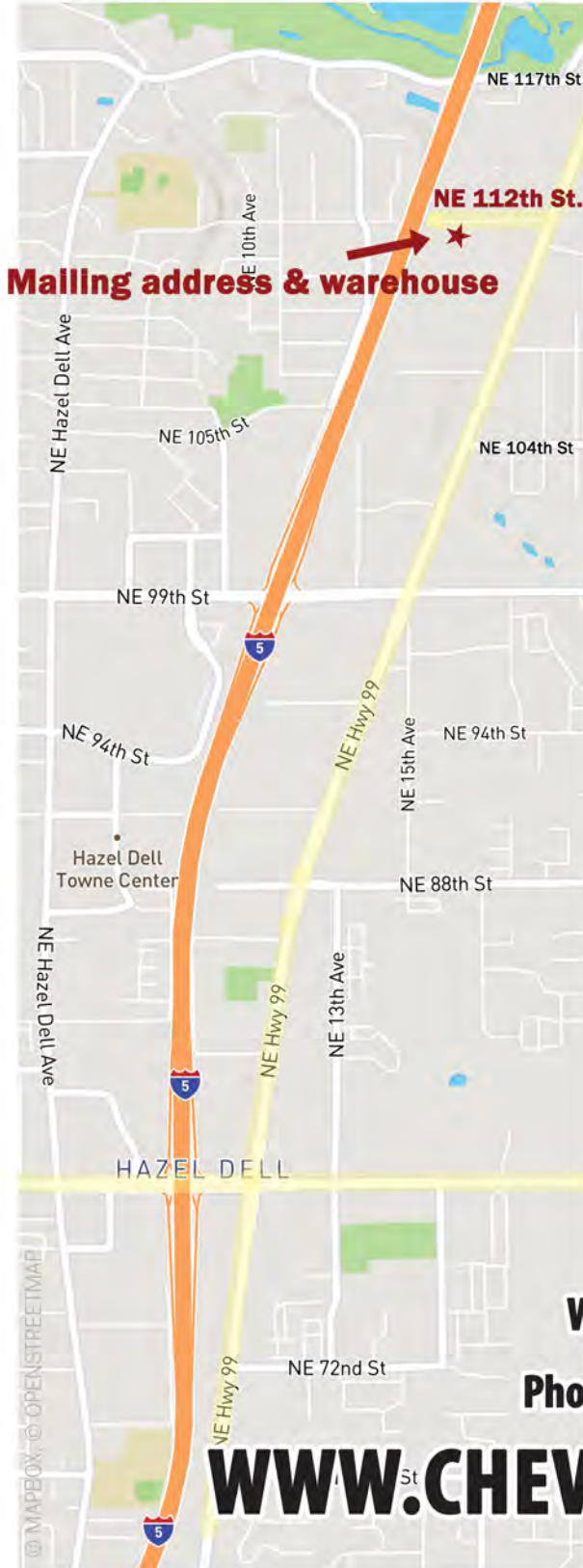

### West Coast Hours

Will Call: M-F 8 a.m. – 5 p.m.

Phone Orders: M-F 6 a.m. – 5 p.m.

**WWW.CHEVSOFTHE40S.COM**



Visit us  
online!